

Kraniomaxillofaziale Chirurgie – Spezialinstrumente  
Craniomaxillofacial Surgery – Special Instruments  
Cirugía cráneo-maxilofacial – instrumentos especiale  
Chirurgie crânio-maxillofaciale – instruments spécifiques  
Chirurgia cranio-maxillofaciale – strumenti speciali



Instruments for Craniomaxillofacial Surgery





Surgical Innovation is our Passion



## Spezialinstrumente für die Kraniomaxillofaziale Chirurgie

Besondere Disziplinen benötigen spezielle Werkzeuge. Dieser Katalog enthält eine Zusammenstellung von etablierten Instrumenten die von namhaften Mund-, Kiefer- und Gesichtschirurgen entwickelt wurden. Der ständige Dialog mit weltweit führenden Spezialisten zeichnet den kontinuierlichen Fortschritt in unserem Produktportfolio aus. Gleichwohl sind alle unsere Instrumente qualitativ erstklassig und werden höchsten Ansprüchen gerecht.

GB

### Special instruments for craniomaxillofacial surgery

Specialist disciplines require special tools. This catalog contains a listing of established instruments that have been developed by renowned maxillofacial surgeons. A constant dialog with leading specialists helps us to maintain continuous progress in our product portfolio. In addition, all of our instruments are manufactured to the highest quality standards and are designed to meet the most exacting demands.

ES

### Instrumentos especiales para la cirugía craneomaxilofacial

Las especialidades singulares requieren herramientas específicas. Este catálogo contiene una compilación de instrumentos acreditados que han sido desarrollados por renombrados cirujanos orales y maxilofaciales. El diálogo continuo con especialistas destacados a nivel mundial distingue el progreso continuo en nuestro catálogo de productos. Así, nuestros instrumentos son de primera calidad y satisfacen los requisitos más exigentes.

F

### Instruments spécifiques à la chirurgie crâniomaxillofaciale

Des disciplines particulières nécessitent des outils spécifiques. Le présent catalogue contient une compilation d'instruments éprouvés qui ont été développés par de célèbres spécialistes en chirurgie buccale et chirurgiens maxillofaciaux. L'évolution continue de notre gamme de produits est le fruit du dialogue permanent que nous entretenons avec les principaux spécialistes mondiaux. Tous nos instruments sont néanmoins de très haute qualité et conviennent aux exigences les plus élevées.

I

### Strumenti speciali per la chirurgia craniomaxillofaciale

Discipline speciali richiedono strumenti speciali. Questo catalogo contiene una panoramica di strumenti consolidati messi a punto da rinomati chirurghi oro-maxillofacciali. Il dialogo costante con specialisti di fama mondiale contraddistingue la continua evoluzione della nostra gamma di prodotti. Tutti i nostri strumenti sono di qualità eccellente e soddisfano i requisiti più rigorosi.



## Qualitätssicherung ohne Kompromisse

Unsere Produkte erfüllen den Anspruch anwendungsbezogener Funktionalität, intelligenter Handhabung und hoher Qualität. Und wenn es um die Erfüllung dieses Anspruchs geht, machen wir keine Kompromisse. Um dies zu gewährleisten, unterhält KLS Martin ein eigenes hochmodernes Labor sowie ein Technikum, in denen die Qualität unserer Erzeugnisse – auch unter extremen Bedingungen – auf „Herz und Nieren“ getestet und dokumentiert werden.

GB

### Quality assurance uncompromising

Our products are designed to consistently meet high demands for application-oriented functionality, intelligent operation and top quality. And we are not prepared to compromise when it comes to meeting the justified expectations of our customers, present and future – your standards become ours. KLS Martin runs their own ultramodern laboratories and a pilot plant, where our products are stress-tested under extreme conditions – every step

ES

### Un seguro de calidad sin compromisos

Nuestros productos cumplen el requisito de estar dotados de la funcionalidad conforme a su aplicación, su manipulación es inteligente y son de alta calidad. No transigimos a la hora de cumplir con estas condiciones esenciales. Por este motivo, KLS Martin mantiene un laboratorio propio, altamente moderno, así como una escuela técnica, donde se ensaya y documenta la calidad de nuestros productos – inclusive bajo condiciones extremas –, examinándolos “hasta la médula”.

F

### Une assurance qualité sans compromis

Nos produits répondent aux exigences requises par une fonctionnalité relative à l'application, un maniement intelligent et une qualité élevée. Et nous n'acceptons aucun compromis lorsqu'il s'agit de répondre à ces exigences. KLS Martin possède à ce but son propre laboratoire ultramoderne et son centre technique dans lesquels la qualité de nos produits fabriqués est testée minutieusement – même sous des extrêmes conditions – et les résultats des tests sont documentés.

I

### Assicurazione della qualità senza compromessi

I nostri prodotti sono stati progettati guardando alle esigenze della prassi applicativa, offrono una manipolazione intelligente e sono di qualità elevata. A tale riguardo non facciamo compromessi. Per garantire questo standard, KLS Martin ha un laboratorio altamente moderno e un centro tecnologico in cui controlla e documenta la qualità di tutti i prodotti, anche in condizioni estreme.

## Wir setzen Standards für die Instrumentenaufbereitung

Wie lassen sich Medizinprodukte vor mechanischer, thermischer oder chemischer Belastung schützen? Was muss man bei der Aufbereitung und Pflege besonders feingliedriger Mikrochirurgieinstrumente berücksichtigen? Als Mitglied wichtiger Gremien und Arbeitskreise – wie z. B. dem Arbeitskreis Instrumenten-Aufbereitung AKI – gibt KLS Martin Antworten und erarbeitet Lösungen für die optimale Aufbereitung und Pflege von Instrumenten. Von der Auswahl angemessener Reinigungsverfahren bis hin zu Sterilisationsverfahren.

GB

### Standards and best practice: instrument preparation

How best to protect surgical instruments from mechanical, thermal and chemical stresses? What steps are performed to ensure optimal preparation and care of highly delicate microsurgical instruments? KLS Martin, in their capacity as member of important advisory boards and working groups – for example, Working Group Instrument Preparation AKI – is in a position to provide answers and solutions to all inquiries with regard to the optimal preparation and care of instruments, ranging from knowledgeable advice on appropriate cleaning methods through sterilization processes.

ES

### Los estándares y la mejor práctica para la preparación de instrumentos

¿Cómo se pueden proteger los productos médicos contra la actuación de factores mecánicos, térmicos y químicos? ¿Qué es lo que hay que considerar en el momento de preparación y cuidado del instrumental microquirúrgico, constituido fundamentalmente por componentes finos? En función de miembro de asociaciones y comités laborales importantes – como por ejemplo, el Comité Alemán de Trabajo de Preparación de Instrumental AKI – KLS Martin ofrece respuestas y elabora soluciones para el tratamiento y cuidado óptimos del instrumental. Éstas abarcan desde la selección de métodos de limpieza adecuados hasta el procedimiento de esterilización.

F

### Normes et pratiques idéales pour la préparation des instruments

Comment protéger les produits médicaux contre d'éventuelles contraintes mécaniques, thermiques ou chimiques? Quels points doivent être pris en considération pour le traitement et l'entretien d'instruments micro-chirurgicaux à fine ossature? A titre de membre d'importants organismes et cercles de travail, tels que par exemple l'AKI (Arbeitskreis Instrumenten-Aufbereitung = cercle de travail pour le traitement des instruments), KLS Martin donne des réponses et élabore des solutions pour assurer un traitement et un entretien optimaux des instruments. Depuis la sélection de procédés de nettoyage adéquats jusqu'au procédé de stérilisation.

I

### Standard e “best practice” per la preparazione degli strumenti

Come si possono proteggere gli strumenti medici da agenti aggressivi di tipo meccanico, termico o chimico? Cosa occorre tenere presente nella preparazione e nella manutenzione di strumenti microchirurgici particolarmente delicati? Quale membro di importanti organi e gruppi di lavoro, come ad esempio AKI, il gruppo tedesco di lavoro per la corretta preparazione degli strumenti, KLS Martin dà risposta e sviluppa soluzioni per la preparazione e la manutenzione ottimali degli strumenti, dalla scelta dei sistemi di pulizia più idonei alle procedure di sterilizzazione.







Wir bieten Ihnen die Möglichkeit, zu Ihrem KLS-Martin-Produkt die passende Gebrauchsanweisung digital anzufordern.

Gebrauchsanweisung anfordern

Anrede

Titel



## Erläuterungen zum Katalog

Catalog explanations

Explicaciones complementarias al catálogo

Explications sur le catalogue

Spiegazioni relative al catalogo



Edelstahl · stainless steel  
acero inoxidable · acier inoxydable  
acciaio inossidabile



Titan · titanium · titanio  
titane · titanio



Verchromt · chrome-plated  
cromado · chromé · cromato



Ferrozell



Silikon · Silicone  
Silicona · Silicone · Silicone



Solid Black  
Hartstoffbeschichtung (für eine längere Standzeit)  
Hard-coated surface (for extended life)  
Recubrimiento con material duro (para una vida útil más larga)  
Revêtement à surface dure (pour une durée de vie prolongée)  
Rivestimento in materiale rigido (per una più lunga durata)



Verweis · Reference · Referencia  
Référence · Rimando



Anzahl Zähne · number of teeth  
cantidad de dientes · quantité de  
dents · quantità di denti



Kaltlicht · cold light · luz fría  
lumière froide · luce fredda

### TC GOLD

TC-Hartmetall im Arbeitsende  
Tungsten carbide in working end  
Carburo de tungsteno en el extremo de trabajo  
Carbure de tungstène sur extrémité de travail  
Carburo di tungsteno nell'estremità operativa



**Atrauma**

Atrauma-Zahnung  
Atraumatic serration  
Dentado atraumático  
Dentelure Atrauma  
Dentatura atraumatica

Übersichtstafel  
Table of Contents  
Tabla de catálogo  
Contenu  
Indice di catalogo





# Übersichtstafel

Table of Contents

Tabla de catálogo

Contenu

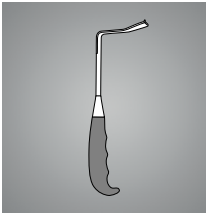
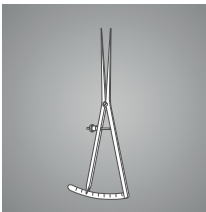
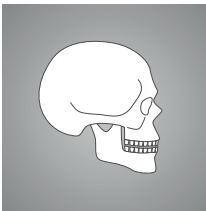
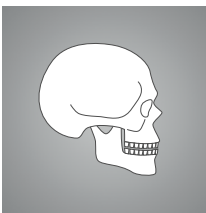
Indice di catalogo

1-4		Jaboma Spalt-Instrumentarium für Lippen-, Kiefer-, Gaumenspalte Jaboma Cleft Palate Set for Cleft Palate Jaboma Instrumental para operaciones del paladar para fisura paladar Set d'instruments Jaboma pour fente du palais pour fente labio-maxillo-palatine Set di strumenti Jaboma per cheilo-labbro-palato schisi
5-11		Instrumente der Endo-Condyle Unit Endo-Condyle Unit instruments Instrumentos Endo-Condyle Unit Instruments unité endo-condylienne Strumenti per Endo-Condyle Unit
13-14		Messzirkel Caliphers Compases Compas Compassi
15-115		Spezialinstrumente für die Kraniomaxillofaziale Chirurgie Special instruments for craniomaxillofacial surgery Instrumentos especiales para la cirugía cráneo-maxilofacial Instruments spécifiques à la chirurgie crânio-maxillofaciale Strumenti speciali per la Chirurgia cranio-maxillofaciale
116-125		Instrumentarium Arnett FAB Orthognathie-System Instrumentation Arnett FAB Orthognathic System Instrumental sistema ortognático FAB Arnett Instruments Arnett pour système d'orthognathie FAB Strumenti per sistema di ortognazia Arnett FAB
129-143		Index Index Indice Index Indice

**Weitere Kataloge von KLS Martin**

Zu den folgenden Produktgruppen sind jeweils eigene Kataloge verfügbar, die Sie gerne bei uns anfordern können:

**Further catalogs of KLS Martin**

For the following product groups additional catalogs are available. Please ask for your personal copy:

**Más catálogos de KLS Martin**

Para los grupos siguientes tenemos catálogos individuales disponibles. No duden pedirnos más ejemplares:

**Autres catalogues de KLS Martin**

Pour les groupes de produits suivants sont disponibles des catalogues additionnels dont vous pouvez demander le nombre désiré:

**Altri cataloghi di KLS Martin**

Per i gruppi di prodotti seguenti sono disponibili cataloghi addizionali. La preghiamo di informarci se desidera altre copie:

Deckenversorgungseinheiten  
Ceiling-mounting systems  
Unidades de alimentación de techo  
Unités d'alimentation montées au plafond  
Sistemi pensili

OP-Leuchten  
Operating Theatre Lights  
Lámparas de quirófano  
Lampes opératoires  
Lampade scialitiche

HF-Chirurgie  
HF Surgery  
Cirugía AF  
Chirurgie HF  
Chirurgia AF

Mund-, Kiefer- und Gesichtschirurgie  
Oral and Craniomaxillofacial surgery  
Cirugía oral y maxilofacial  
Chirurgie orale et maxillofaciale  
Chirurgia orale e maxillofacciale

microStop®-Sterilcontainer  
microStop® Sterile Containers  
Contenedores estériles microStop®  
Conteneurs stériles microStop®  
Contentitori per la sterilizzazione microStop®



Jaboma Spalt-Instrumentarium für Lippen-, Kiefer-, Gaumenspalte  
Jaboma Cleft Palate Set for Cleft Palate  
Jaboma Instrumental para operaciones del paladar para fisura paladar  
Set d'instruments Jaboma pour fente du palais pour fente labio-maxillo-palatine  
Set di strumenti Jaboma per cheilo-labbro-palato schisi

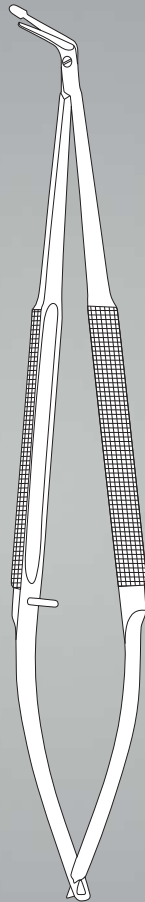

## Jaboma Spalt-Instrumentarium für Lippen-, Kiefer-, Gaumenspalte

Jaboma Cleft Palate Set for Cleft Palate

Jaboma Instrumental para operaciones del paladar para fisura paladar

Set d'instruments Jaboma pour fente du palais pour fente labio-maxillo-palatine

Set di strumenti Jaboma per cheilo-labbro-palato schisi



Jaboma  
11-765-18-07

18 cm / 7 1/8"

Schere, links gebogen  
Scissors, left curved  
Tijeras, curvo a la izquierda  
Ciseaux, courbé à gauche  
Forbici, curvo sinistro



Jaboma  
11-767-18-07

18 cm / 7 1/8"

Schere, rechts gebogen  
Scissors, right curved  
Tijeras, curvo por derecho  
Ciseaux, courbé à droite  
Forbici, curvo a destra



Jaboma  
11-769-18-07

18 cm / 7 1/8"

Mikro-Präparierschere  
Micro dissecting scissors  
Micro-tijeras de disección  
Micro-ciseaux à dissection  
Micro-forbici per dissezione





TC GOLD



Jaboma  
12-276-18-07

18 cm / 7 1/8"

TC-Pinzette  
TC forceps  
Pinza TC  
Pince TC  
Pinza TC



Jaboma  
12-278-18-07

18 cm / 7 1/8"

TC-Pinzette  
TC forceps  
Pinza TC  
Pince TC  
Pinza TC

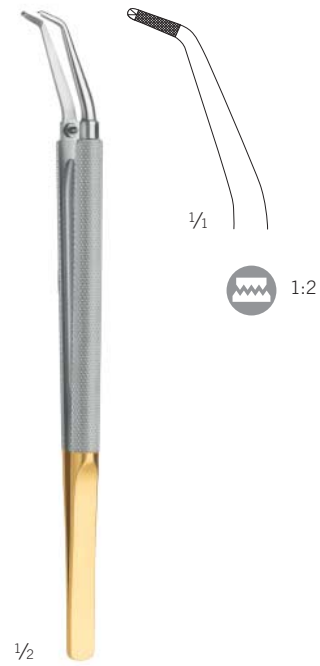

Jaboma  
12-279-18-07

18 cm / 7 1/8"

TC-Pinzette  
TC forceps  
Pinza TC  
Pince TC  
Pinza TC

## Jaboma Spalt-Instrumentarium für Lippen-, Kiefer-, Gaumenspalte

Jaboma Cleft Palate Set for Cleft Palate

Jaboma Instrumental para operaciones del paladar para fisura paladar

Set d'instruments Jaboma pour fente du palais pour fente labio-maxillo-palatine

Set di strumenti Jaboma per cheilo-labbro-palato schisi

### TC GOLD



Jaboma  
20-610-18-07

18 cm / 7 1/8"

TC-Nadelhalter  
TC needle holder  
Porta-aguja TC  
Porte-aiguille TC  
Portaghi TC

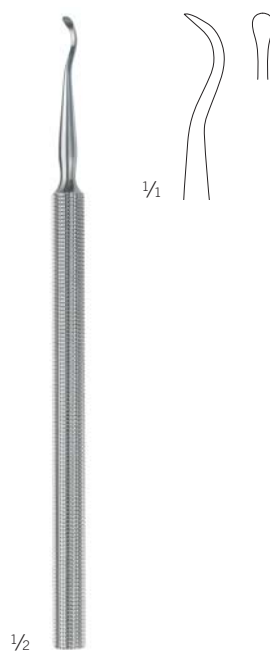

Jaboma  
39-100-17-07

17 cm / 6 5/8"

Gaumenspalt-Raspatorium  
Cleft palate raspatory  
Periostótomo para fisura palatina  
Rugine-raspatoire pour fente palatine  
Periostotomo per palato schisi

Instrumente der Endo-Condyle Unit  
Endo-Condyle Unit instruments, repositioning instruments  
Instrumentos Endo-Condyle Unit, instrumentos de reposición  
Instruments unité endo-condylienne, instruments de repositionnement  
Strumenti per Endo-Condyle Unit, strumenti di riposizionamento

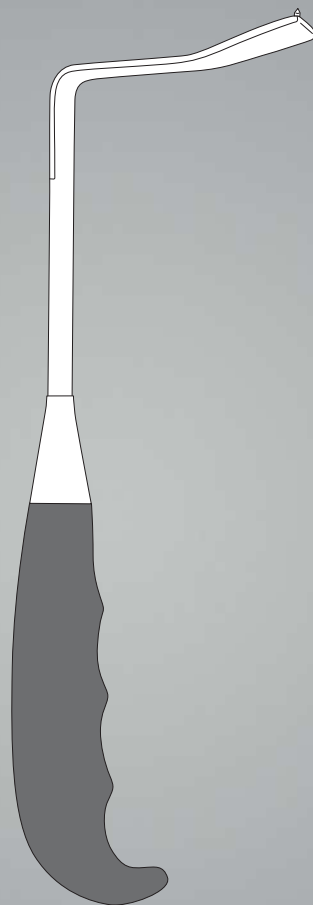

## Instrumente der Endo-Condyle Unit, Repositionsinstrumente

Endo-Condyle Unit instruments, repositioning instruments

Instrumentos Endo-Condyle Unit, instrumentos de reposición

Instruments unité endo-condylienne, instruments de repositionnement

Strumenti per Endo-Condyle Unit, strumenti di riposizionamento

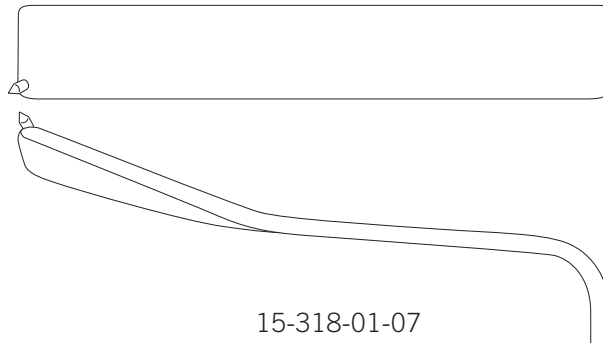

15-318-01-07

rechts  
right  
derecho  
droit  
destra

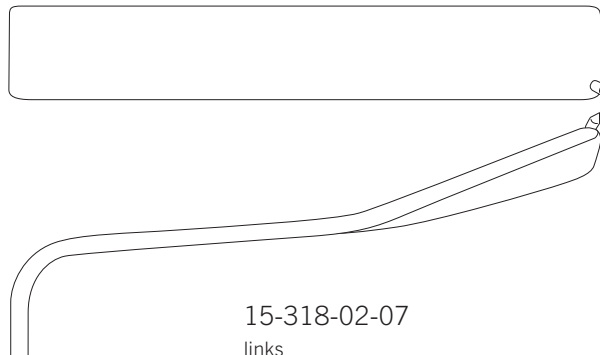

15-318-02-07

links  
left  
izquierdo  
gauche  
sinistra

15-318-01-07 -  
15-318-02-07

24,5 cm/9 7/8"

Ramus-Retractor, mit Dorn  
Ramus retractor, with mandrel  
Retractor de rama, con espiga  
Rétracteur de ramus, avec pointe  
Separatore per ramo, con mandrino

Sic

## Instrumente der Endo-Condyle Unit, Repositionsinstrumente

Endo-Condyle Unit instruments, repositioning instruments  
Instrumentos Endo-Condyle Unit, instrumentos de reposición  
Instruments unité endo-condylienne, instruments de repositionnement  
Strumenti per Endo-Condyle Unit, strumenti di riposizionamento

## Kraniomaxillofaziale Chirurgie

Craniomaxillofacial surgery  
Cirugía cráneo-maxilofacial  
Chirurgie crânio-maxillofaciale  
Chirurgia cranio-maxillofaciale

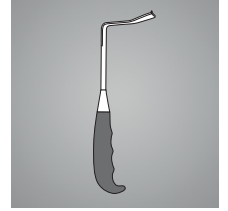

1/2

38-684-01-07

24 cm/9 1/8"

Ramus-Reetraktor, scharf  
Ramus retractor, sharp  
Retractor de rama, afilado  
Rétracteur de ramus, aiguisé  
Separatore per ramo, acuto



1/2

38-715-22 07

21,5 cm/8 1/2"

Ramus-Reetraktor mit Dorn, gewinkelt  
Ramus retractor with mandrel, angled  
Retractor de rama con espiga, acodado  
Rétracteur de ramus avec pointe, angle  
Separatore per ramo, con mandrino, angolato



1/2

38-684-02-07

25,5 cm/10"

Ramus-Reetraktor, gerade  
Ramus retractor, straight  
Retractor de rama, recto  
Rétracteur de ramus, droit  
Separatore per ramo, diritto



## Instrumente der Endo-Condyle Unit, Repositionsinstrumente

Endo-Condyle Unit instruments, repositioning instruments

Instrumentos Endo-Condyle Unit, instrumentos de reposición

Instruments unité endo-condylienne, instruments de repositionnement

Strumenti per Endo-Condyle Unit, strumenti di riposizionamento

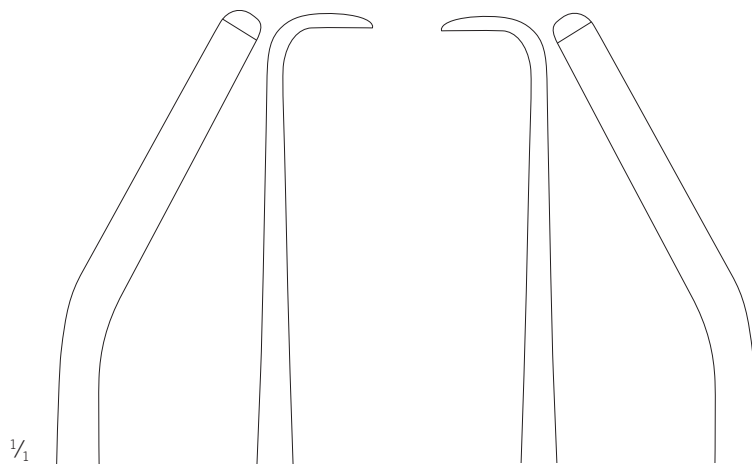

37-544-03-07

links  
left  
izquierdo  
gauche  
sinistra

37-544-04-07

rechts  
right  
derecho  
droit  
destra

37-544-03-07 -  
37-544-04-07

25,5 cm/10"

Elevatorium, breit  
Elevator, wide  
Elevador, ancho  
Élévateur, large  
Elevatore, largo

Sic

## Instrumente der Endo-Condyle Unit, Repositionsinstrumente

Endo-Condyle Unit instruments, repositioning instruments  
Instrumentos Endo-Condyle Unit, instrumentos de reposición  
Instruments unité endo-condylienne, instruments de repositionnement  
Strumenti per Endo-Condyle Unit, strumenti di riposizionamento

## Kraniomaxillofaziale Chirurgie

Craniomaxillofacial surgery  
Cirugía cráneo-maxilofacial  
Chirurgie crânio-maxillofaciale  
Chirurgia cranio-maxillofaciale

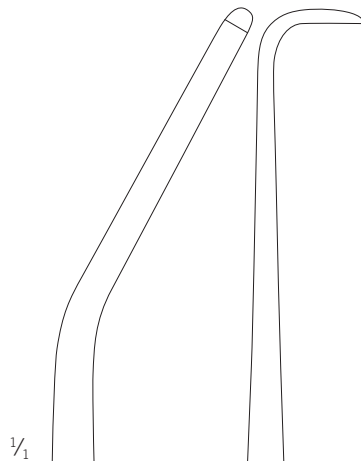
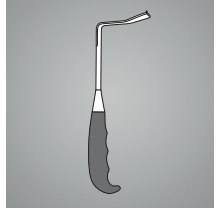

37-544-05-07

links  
left  
izquierdo  
gauche  
sinistra

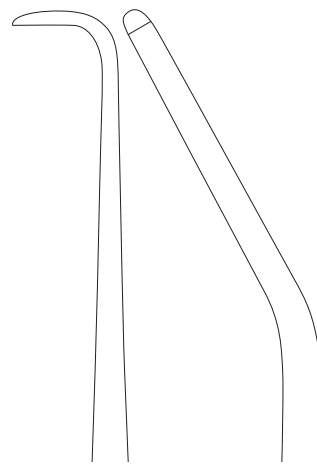

37-544-06-07

rechts  
right  
derecho  
droit  
destra

37-544-05-07 -  
37-544-06-07

25,5 cm/10"

Elevatorium, schmal  
Elevator, narrow  
Elevador, estrecho  
Élévateur, fin  
Elevatore, stretto

Sic

## Instrumente der Endo-Condyle Unit, Repositions- und Zugangsinstrumente

Endo-Condyle Unit instruments, repositioning and access instruments

Instrumentos Endo-Condyle Unit, instrumentos de reposición y acceso

Instruments unité endo-condylienne, instruments de repositionnement et d'accès

Strumenti per Endo-Condyle Unit, strumenti di riposizionamento e accesso

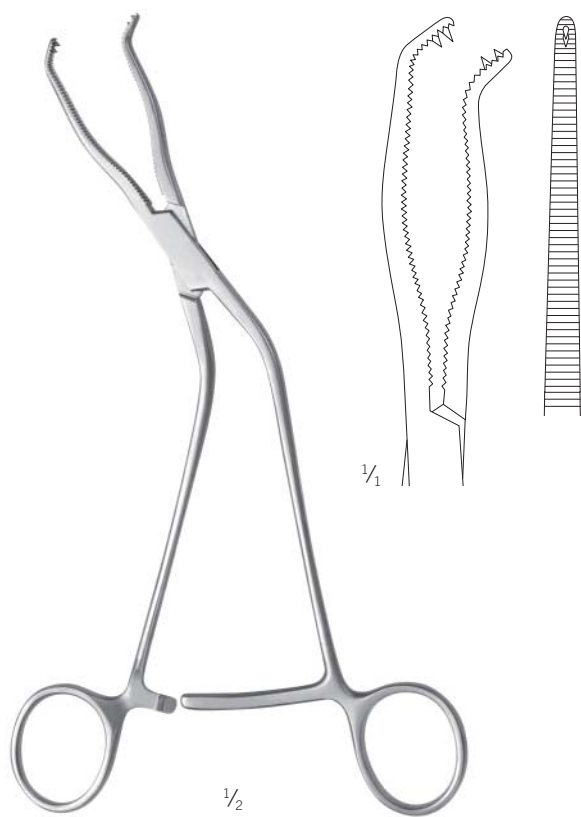

50-242-12-07

21,5 cm/8 5/8"

Repositionsklemme universell nutzbar (links+ rechts)

Endo-Condyle Unit instruments, repositioning and access instruments

Instrumentos Endo-Condyle Unit, instrumentos de reposición y acceso

Instruments unité endo-condylienne, instruments de repositionnement et d'accès

Strumenti per Endo-Condyle Unit, strumenti di riposizionamento e accesso

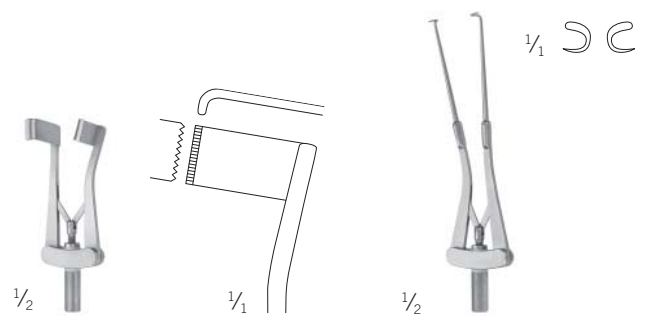

15-716-01-07

7 cm/2 3/4"

Wundspreizer, gezahnt

Surgical spreader, serrated

Separado, dentado

Écarteur autostatique, denté

Divaricatore autostatico, dentato

15-716-03-07

10 cm/3 7/8"

Wundspreizer, fein

Surgical spreader, fine

Separador, fino

Écarteur autostatique, fin

Divaricatore autostatico, fine



## Instrumente der Endo-Condyle Unit, Stabilisierungsinstrumente

Endo-Condyle Unit instruments, stabilizing instruments  
Instrumentos Endo-Condyle Unit, instrumentos estabilizadores  
Instruments unité endo-condylienne, instruments de stabilisation  
Strumenti per Endo-Condyle Unit, strumenti di stabilizzazione

## Kraniomaxillofaziale Chirurgie

Craniomaxillofacial surgery  
Cirugía cráneo-maxilofacial  
Chirurgie crânio-maxillofaciale  
Chirurgia cranio-maxillofaciale

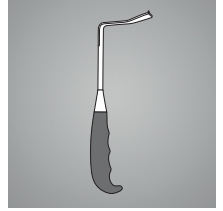

38-684-03-07

26 cm/10 5/8"

Metz-Haken, modifiziert, rechts  
Metz hook, modified, right  
Gancho Metz, modificado, derecha  
Crochet de Metz, modifié, droit  
Divaricatore di Metz, modificato, destra



38-684-04-07

26 cm/10 5/8"

Metz-Haken, modifiziert, links  
Metz hook, modified, left  
Gancho Metz, modificado, izquierda  
Crochet de Metz, modifié, gauche  
Divaricatore di Metz, modificato, sinistra





Messzirkel  
Calipers  
Compasses  
Compas  
Compassi

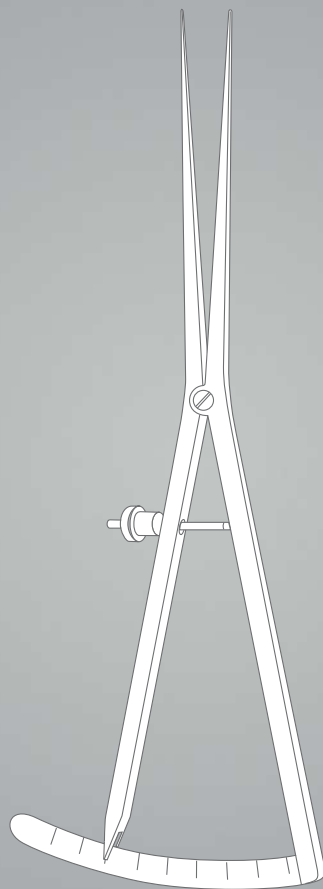

## Messzirkel

Calipers

Compasses

Compas

Compassi



1/2

Castroviejo  
35-133-06-07

8 cm / 3 1/8"

Messbereich  
effective range  
alcance eficaz  
série effectif  
rango effective  
**0-15 mm**



1/2

Castroviejo  
35-133-07-07

8 cm / 3 1/8"

Messbereich  
effective range  
alcance eficaz  
série effectif  
rango effective  
**0-20 mm**



1/2

Castroviejo  
35-133-09-07

8 cm / 3 1/8"

Messbereich  
effective range  
alcance eficaz  
série effectif  
rango effective  
**0-20 mm**



1/2

Castroviejo-Epker  
35-134-09-07

9 cm / 3 4/8"

Messbereich  
effective range  
alcance eficaz  
série effectif  
rango effective  
**0-40 mm**



1/2

Castroviejo-Epker  
35-134-18-07

18 cm / 7 1/8"

Messbereich  
effective range  
alcance eficaz  
série effectif  
rango effective  
**0-40 mm**



1/2

Castroviejo-Epker  
35-135-18-07

18 cm / 7 1/8"

Messbereich  
effective range  
alcance eficaz  
série effectif  
rango effective  
**0-40 mm**

---

Spezialinstrumente für die Krianiomaxillofaziale Chirurgie  
Special instruments for craniomaxillofacial surgery  
Instrumentos especiales para la cirugía cráneo-maxilofacial  
Instruments spécifiques à la chirurgie crânio-maxillofaciale  
Strumenti speciali per la Chirurgia cranio-maxillofaciale

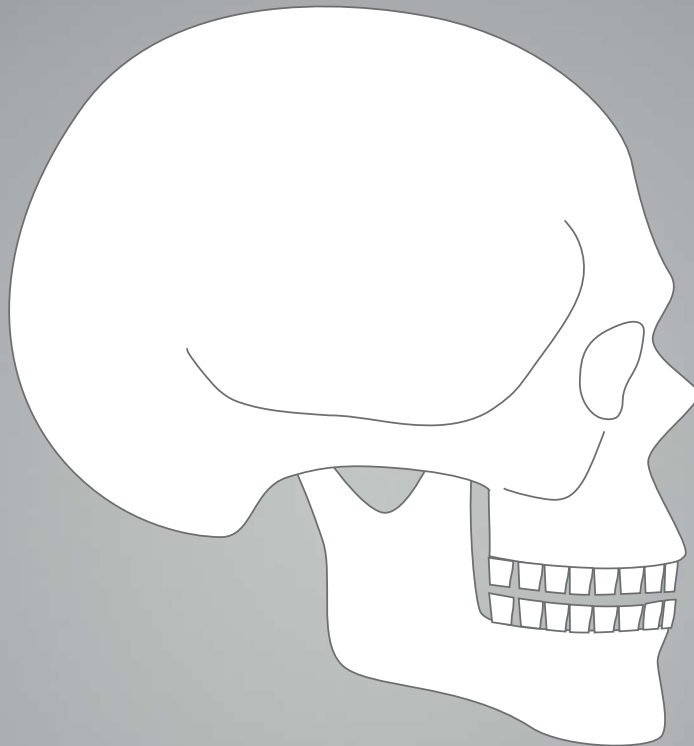

## Elevatorien, Transplantatstopfer

Elevators, Graft Packers

Elevadores, Atacadores de trasplantes

Elévateurs, Poussoirs pour transplantation

Elevatori, Turatori per innesti

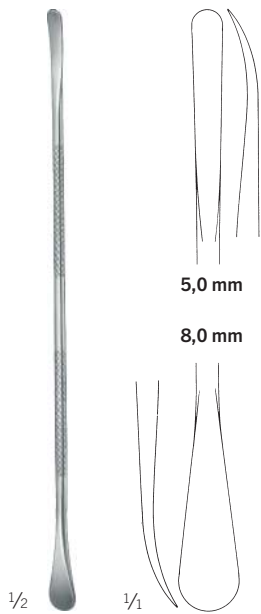

Terry  
38-011-16-07

17 cm / 6 <sup>5</sup>/<sub>8</sub>"

zur Alveolarlappenabhebung  
for elevation of alveolar flaps  
para la elevación de las aletas alveolares  
pour élévation du lambeau alvéolaire  
per la elevazione del lembo alveolare

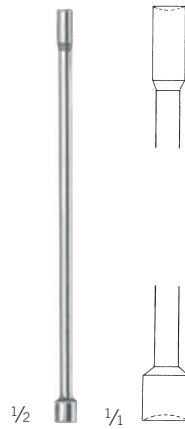

Terry  
38-012-16-07

11,5 cm / 4 <sup>1</sup>/<sub>8</sub>"

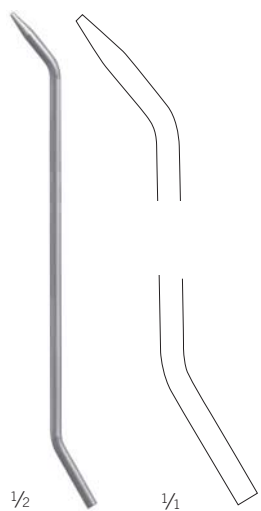

Terry  
38-013-13-07

13 cm / 5 <sup>1</sup>/<sub>8</sub>"



Terry  
38-014-00-07

18 cm / 7 <sup>1</sup>/<sub>8</sub>"

## Fräser

Burrs  
Fresas  
Mèches  
Alesatori

## Kraniomaxillofaziale Chirurgie

Craniomaxillofacial surgery  
Cirugía cráneo-maxilofacial  
Chirurgie crânio-maxillofaciale  
Chirurgia cranio-maxillofaciale



1/2

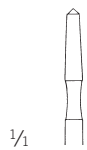

1/4

38-050-45-09  
4,5 cm / 1 6/8"



Arbeitslänge  
working length  
largo útil  
longueur utile  
lunghezza utile  
**10 mm**



38-050-65-09  
6,5 cm / 2 4/8"



Arbeitslänge  
working length  
largo útil  
longueur utile  
lunghezza utile  
**22 mm**



38-050-80-09  
8 cm / 3 1/8"



Arbeitslänge  
working length  
largo útil  
longueur utile  
lunghezza utile  
**35 mm**



1/2

38-051-45-07  
8 cm / 3 1/8"



Arbeitslänge  
working length  
largo útil  
longueur utile  
lunghezza utile  
**10 mm**

### Lindemann

38-050-45-09 -  
38-051-45-07

zur vertikalen Spaltung im bukkalen  
Bereich des Unterkiefers

for vertical cuts in the buccal aspect  
of the mandible

para cortes verticales en el aspecto  
bucal de la mandíbula

pour séparation verticale dans la zone buccale  
mandibulaire dans la mâchoire inférieure

per osteotomie verticali nella zona  
buccale della mandibula

## Mundkeile, Mundsperrer

Mouth Gags, Mouth Gags

Abrebocas, Abrebocas

Baïllons, Ouvre-bouche

Apribocca, Apribocca

Cr



1/2

Adams  
38-103-01-02

Serviettenhalter  
Napkin Holder  
Porta-servilleta  
Porte-serviettes  
Porta-salviette

Gesamtlänge  
Overall length  
Longitud total  
Longueur totale  
Lunghezza complessiva

**50 cm**

Cr



1/2

Langenbeck  
38-111-02-02  
Ø 26 / 20 mm



1/2

Maunder  
38-120-10-04  
9,5 cm / 3 7/8"  
Holz  
wood  
madera  
bois  
legno



1/2

Pitha  
38-127-02-04

Silikon  
silicone  
silicona  
silicone  
silicona

**28 x 30 mm**



1/1

McKesson

kunststoffbeschichteter Metallrahmen  
ohne Kette

plastic coated metal frame  
without chain

cuadro metálico, cubierto de plástico  
sin cadena

cadre métal avec revêtement synthétique  
sans chaîne

telaio metallico, ricoperto in plastica  
senza catena

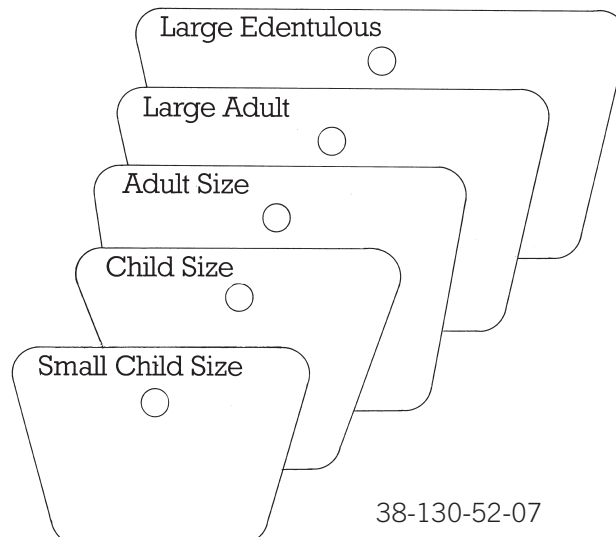

38-130-52-07

groß, für Erwachsene  
large, for adults  
grande, para adultos  
grand, pour adultes  
grande, per adulti

38-130-56-07

klein, für Kinder  
small, for children  
pequeño, para niños  
petit, pour enfants  
piccolo, per bambini

38-130-50-07

extra groß, für Zahnlose  
extra large, for edentulous  
muy grande, para desdentados  
très grand, pour édentées  
molto grande, per sdentati

38-130-54-07

normal, für Erwachsene  
regular, for adults  
regular, para adultos  
regulier, pour adultes  
regolare, per adulti

38-130-58-07

klein, für Kleinkinder  
small, for babies  
pequeño, para bebés  
petit, pour bébés  
piccolo, per neonati

38-130-90-98

Kette, allein, 18 cm  
Chain, only, 18 cm  
Cadena, suelto, 18 cm  
Chaîne, seul, 18 cm  
Catena, solo, 18 cm  
**18 cm**



## Mundsperrer

Mouth Gags  
Abrebocas  
Ouvre-bouche  
Apribocca

## Kraniomaxillofaziale Chirurgie

Craniomaxillofacial surgery  
Cirugía cráneo-maxilofacial  
Chirurgie crânio-maxillofaciale  
Chirurgia cranio-maxillofaciale



1/2

Heister  
38-140-13-07  
13 cm / 5 1/8"



1/2

Molt  
38-161-11-07  
11 cm / 4 3/8"

38-161-93-98

Ersatzgummi  
Spare Rubber  
Goma de repuesto  
Caoutchouc de remplacement  
Gomma di ricambio



38-161-11-07



1/2

Molt  
38-161-14-07  
13 cm / 5 1/8"

38-161-92-98

Ersatzgummi  
Spare Rubber  
Goma de repuesto  
Caoutchouc de remplacement  
Gomma di ricambio



38-161-14-07



1/2

Denhart  
38-171-12-07  
13 cm / 5 1/8"

Backen  
jaws  
bocas  
mors  
branche  
**16 mm**



1/2

Roser-König  
38-179-16-07 -  
38-179-20-07

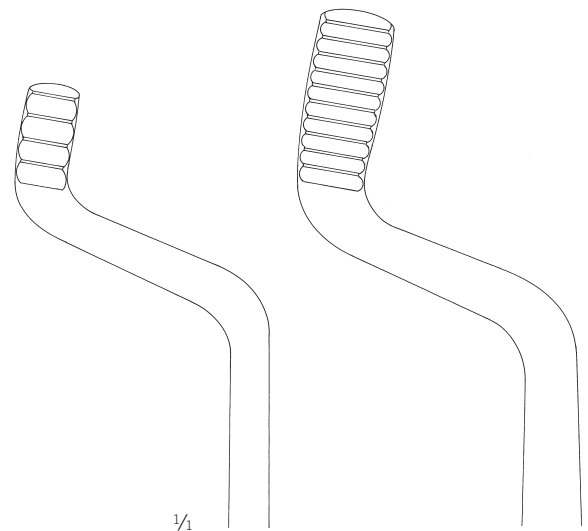

1/1

38-179-16-07  
16 cm / 6 3/8"

38-179-20-07  
19 cm / 7 4/8"

## Mundsperrer

Mouth Gags  
Abrebocas  
Ouvre-bouche  
Apribocca

---



Kilner-Doughty

38-196-00-07

Bruststütze  
Chest Support  
Soporte de pecho  
Support contre-poitrine  
Supporto per petto



38-198-00-07

## Mundsperrer

Mouth Gags  
Abrebocas  
Ouvre-bouche  
Apribocca

## Kraniomaxillofaziale Chirurgie

Craniomaxillofacial surgery  
Cirugía cráneo-maxilofacial  
Chirurgie crânio-maxillofaciale  
Chirurgia cranio-maxillofaciale



1/2



38-198-90-98

Gaumenplatte  
Palate Plate  
Plaquita paldia  
Plaque platine  
Placca per palato

Kilner-Doughty  
38-198-00-07

komplett mit Rahmen, 3 Zungenspatel, 2 Zahnplatten und 1 Gaumenplatte

complete, with frame, 3 tongue depressors, 2 toothplates and 1 palate plate

completo con bastidor, 3 bajalenguas, 2 plaquitas de dientes y 1 plaquita paldia

complet avec cadre, 3 abaisse-langue, 2 plaques pour dents e 1 plaque palatine

completo, con telaio, 3 abassalingua, 2 placche per denti e 1 placca per palato

Kilner-Doughty  
38-198-10-07

14,5 cm / 5 7/8"

Mundsperrer-Rahmen  
Frame for Mouth Gag  
Bastidor para abreboca  
Cadre pour ouvre-bouche  
Telaio per apribocca

➔ 38-198-00-07



1/2

Kilner-Doughty  
38-198-01-07 -  
38-198-03-07

Zungendrucker  
Tongue Depressor  
Bajalengua  
Abaisse-langue  
Abassalingua

gefenestertes Blatt für Absaugung  
fenestrated blade for suction  
hoja fenestrada para succión  
lame fenêtrée pour aspiration  
lama con finestra per aspirazione

Fig. 1  
38-198-01-07  
68 x 30 mm

Fig. 2  
38-198-02-07  
77 x 34 mm

Fig. 3  
38-198-03-07  
82 x 39 mm

➔ 38-198-00-07

# Mundsperrer

Mouth Gags  
Abrebocas  
Ouvre-bouche  
Apribocca



Neukam  
38-208-00-07

komplett mit Rahmen und 3 Zungendrücker  
complete, with frame and 3 tongue depressors  
completo con bastidor y 3 bajalenguas  
complet avec cadre et 3 abaisse-langue  
completo, con telaio e 3 abassalingua

Neukam  
38-208-10-07

Mundsperrer-Rahmen, allein  
Frame for Mouth Gag, only  
Bastidor para abreboca, suelto  
Cadre pour ouvre-bouche, seul  
Telaio per apribocca, solo



65 x 25,5 mm

73 x 28,5 mm

71 x 30,0 mm



38-208-01-07 -  
38-208-03-07

Zungendrücker  
Tongue Depressor  
Bajalengua  
Abaisse-langue  
Abassalingua

gefenestertes Blatt für Absaugung  
fenestrated blade for suction  
hoja fenestrada para succión  
lame fenêtrée pour aspiration  
lama con finestra per aspirazione

1/2

Fig. 1  
38-208-01-07

Fig. 2  
38-208-02-07

Fig. 3  
38-208-03-07



## Mundsperrer

Mouth Gags  
Abrebocas  
Ouvre-bouche  
Apribocca

## Kraniomaxillofaziale Chirurgie

Craniomaxillofacial surgery  
Cirugía cráneo-maxilofacial  
Chirurgie crânio-maxillofaciale  
Chirurgia cranio-maxillofaciale



Davis-Boyle

38-212-00-07

komplett, bestehend aus Rahmen und fünf Zungendrückern Fig. 1 - 5  
complete, consisting of frame and 5 tongue depressors no. 1 -5  
completo, consiste de bastidor y 5 bajalenguas no. 1 - 5  
complet, se composant de cadre e 5 abaisse-langue no. 1 - 5  
completo, composto di telaio e 5 abassalingua no. 1 - 5

38-212-10-07

Mundsperrer-Rahmen  
Frame for Mouth Gag  
Bastidor para abrebooca  
Cadre pour ouvre-bouche  
Telaio per apribocca



38-212-00-07

38-212-50-07

Mundsperrer-Rahmen mit Gelenk  
Frame for Mouth Gag with joint  
Bastidor para abrebooca con articulación  
Cadre pour ouvre-bouche avec joint articulé  
Telaio per apribocca con snodo

38-212-90-98

Silikoneinlage  
Silicone inlay  
Plaquita de silicona  
Plaque de silicone  
Stuoia in silicone



38-212-50-07



38-212-01-07 -  
38-212-05-07

mit fester Absaugung  
with fixed suction tube  
con tubo de succión fijo  
avec tube d'aspiration fixée  
con tubo di aspirazione fisso



38-212-00-07

1/2

Fig. 1  
38-212-01-07  
110 x 26 mm



Fig. 2  
38-212-02-07  
95 x 25 mm



Fig. 3  
38-212-03-07  
85 x 24 mm



Fig. 4  
38-212-04-07  
70 x 23 mm

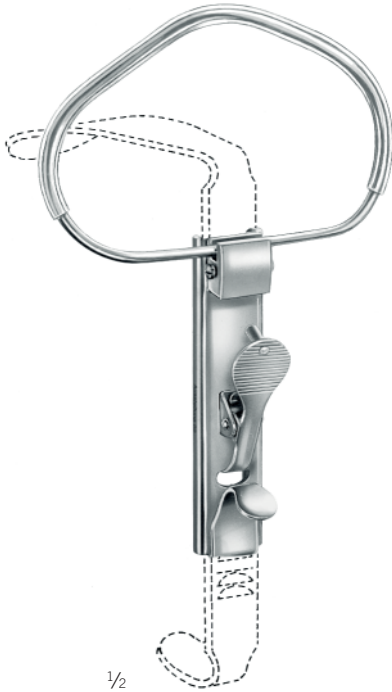

Fig. 5  
38-212-05-07  
30 x 20 mm

ohne Absaugung  
without suction tube  
sin tubo de succión fijo  
sans tube d'aspiration fixée  
senza tubo di aspirazione fisso

## Mundsperrer

Mouth Gags  
Abrebocas  
Ouvre-bouche  
Apribocca



Mclvor  
38-222-00-07

komplett, mit 3 Zungendrucker  
complete, with 3 tongue depressors  
completo, con 3 bajalenguas  
complet, avec 3 abaisse-langue  
completo, con 3 abassalingua

Mclvor  
38-222-10-07

Mundsperrer-Rahmen  
Frame for Mouth Gag  
Bastidor para abreboca  
Cadre pour ouvre-bouche  
Telaio per apribocca



Mclvor  
38-222-01-07 -  
38-222-03-07

Zungendrucker  
Tongue Depressor  
Bajalengua  
Abaisse-langue  
Abassalingua



Fig. 1  
38-222-01-07  
100 x 25 mm



Fig. 2  
38-222-02-07  
85 x 25 mm

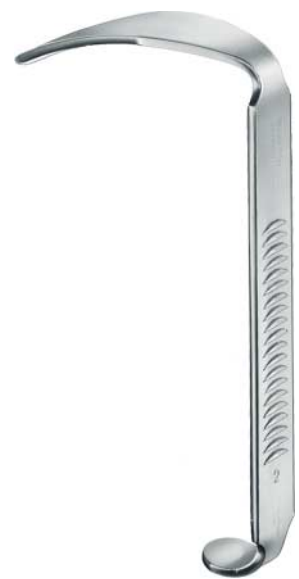

Fig. 3  
38-222-03-07  
75 x 25 mm

## Mundsperrer

Mouth Gags  
Abrebocas  
Ouvre-bouche  
Apribocca

## Kraniomaxillofaziale Chirurgie

Craniomaxillofacial surgery  
Cirugía cráneo-maxilofacial  
Chirurgie crânio-maxillofaciale  
Chirurgia cranio-maxillofaciale

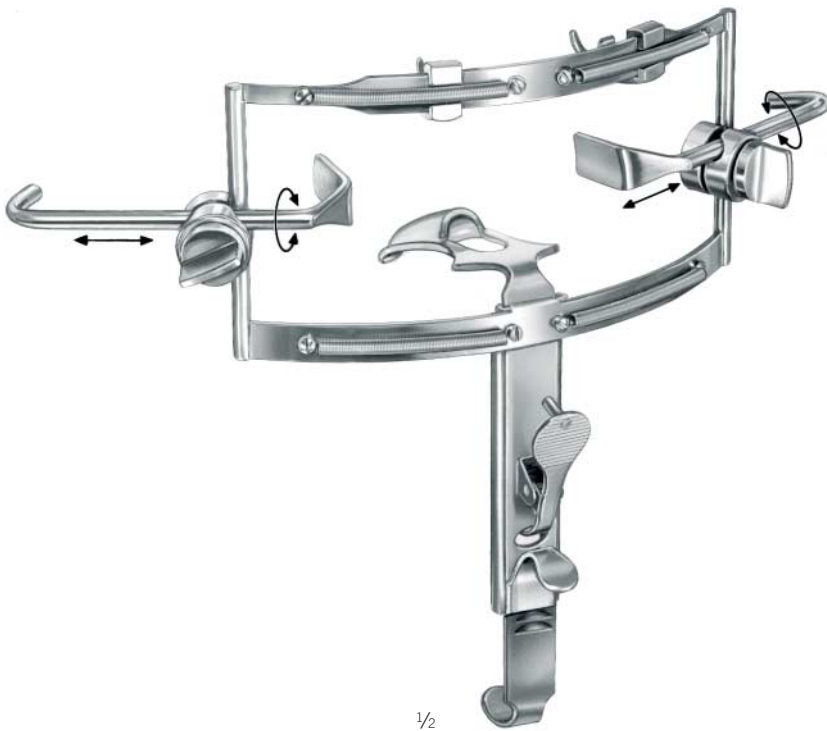

Dingmann  
38-224-00-07

komplett mit Rahmen, 3 Zungendrückern  
und 2 beweglichen Seitenvälven  
complete, with frame, 3 tongue depressors  
and 2 adjustable lateral blades  
completo con bastidor, 3 bajalenguas  
y 2 valvas laterales ajustables  
complet avec cadre, 3 abaisse-langue  
et 2 valves latérales réglables  
completo, con telaio, 3 abassalingua  
e 2 valve laterali movibili

Dingmann  
38-224-01-07 -  
38-224-03-07

Zungendrücker  
Tongue Depressor  
Bajalengua  
Abaisse-langue  
Abassalingua

➔ 38-224-00-07



Fig. 1  
38-224-01-07  
62 x 26 mm

Fig. 2  
38-224-02-07  
65 x 30 mm

Fig. 3  
38-224-03-07  
78 x 32 mm

## Mundsperrer, Lippen- und Wangenhalter

Mouth Gags, Lip and Cheek Retractors  
 Abrebocas, Separadores para labios y mejillas  
 Ouvre-bouche, Ecarteurs des lèvres et joues  
 Apribocca, Separatori per labbra e guancia



1/2

Jennings  
 38-237-09-07 -  
 38-237-15-07

38-237-09-07	10,5 cm / 4 1/8"
38-237-11-07	12,5 cm / 4 7/8"
38-237-13-07	14,5 cm / 5 6/8"
38-237-15-07	16,5 cm / 6 4/8"



1/2

Oringer  
 38-240-00-07  
 9,5 cm / 3 6/8"  
 selbsthaltend, für Kinder  
 self retaining, for children  
 autoestático, para niños  
 autostatique, pour enfants  
 autostatico, per bambini

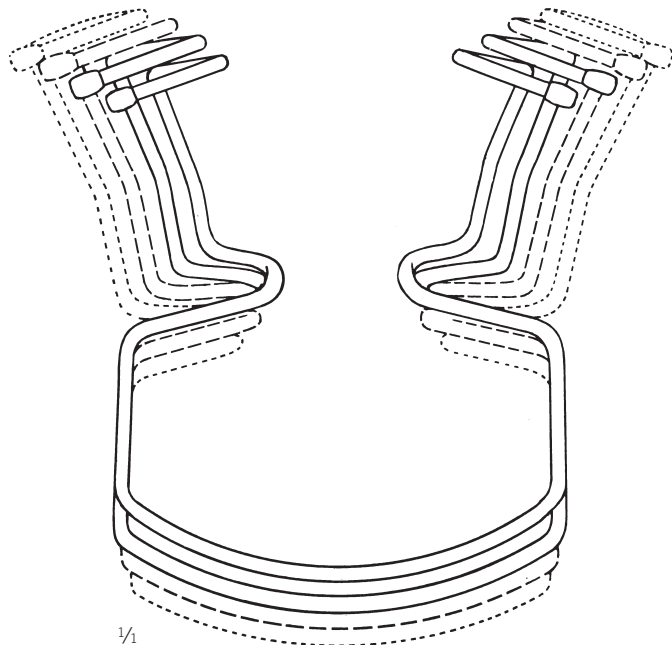

1/1

<b>Fig. 1</b>	38-240-01-07	10 cm / 3 7/8"
<b>Fig. 2</b>	38-240-02-07	10,5 cm / 4 1/8"
<b>Fig. 3</b>	38-240-03-07	11 cm / 4 3/8"

### 38-240-13-07

selbsthaltend	Satz mit Fig. 1-3
self retaining	set with no. 1-3
autoestático	juego de no. 1-3
autostatique	jeu de no. 1-3
autostatico	set con no. 1-3



## Lippen- und Wangenhalter

Lip and Cheek Retractors  
Separadores para labios y mejillas  
Ecarteurs des lèvres et joues  
Separatori per labbra e guancia

## Kraniomaxillofaziale Chirurgie

Craniomaxillofacial surgery  
Cirugía cráneo-maxilofacial  
Chirurgie crânio-maxillofaciale  
Chirurgia cranio-maxillofaciale



48 mm



1/2

Martin-Simplex  
38-243-11-01  
10,5 cm / 4 1/8"

80 mm



1/2

38-246-14-04  
14 cm / 5 4/8"  
Vestibulumhaken  
Vestibulum Retractor  
Separador para vestibulo  
Ecarteur pour vestibulum  
Separatore per vestibulo

26 mm



1/2

37 mm

Sternberg  
38-249-14-01  
14 cm / 5 4/8"



1/2

Obwegeser  
38-251-12-07  
12 cm / 4 6/8"

20 mm



1/2

Bishop  
38-261-13-01  
13,5 cm / 5 3/8"



1/2

Cawood-Minnesota  
38-263-15-01  
15,5 cm / 6 1/8"



1/2

Cawood-Minnesota  
38-265-00-01  
14,5 cm / 5 6/8"



1/2

# Zungendrucker

Tongue Depressors

Abajalenguas

Abaisse-langue

Abassalingua



Hartmann  
38-271-15-07  
15 cm / 5 7/8"



Tobold  
38-277-14-07  
15 cm / 5 7/8"



Tobold  
38-281-14-07  
16 cm / 6 2/8"



Wieder  
38-297-01-01 -  
38-297-02-01

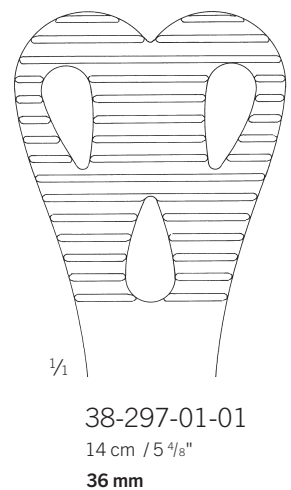
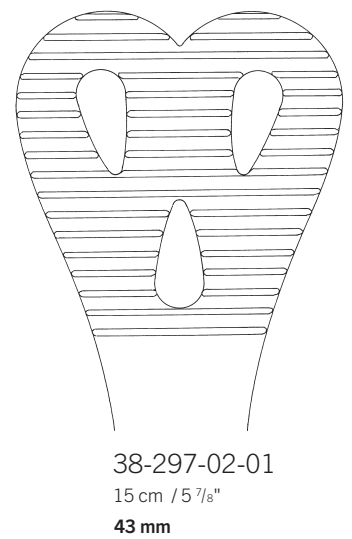



## Lip And Cheek Retractors

Lip And Cheek Retractors

Lip And Cheek Retractors

Lip And Cheek Retractors

Lip And Cheek Retractors

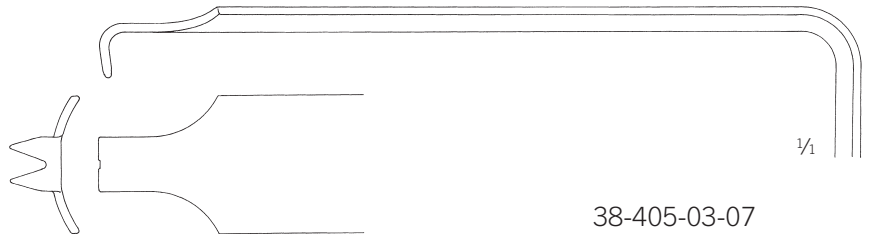
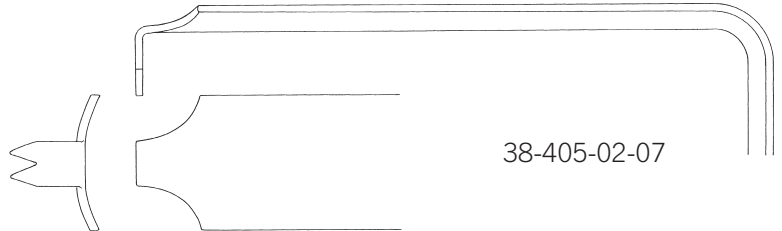

Austin  
38-405-02-07 -  
38-405-03-07  
16 cm / 6  $\frac{2}{8}$ "

## Zungenzangen

Tongue Holding Forceps

Pinzas tira-lengua

Pinces tire-langue

Pinze per lingua

## Kraniomaxillofaziale Chirurgie

Craniomaxillofacial surgery

Cirurgía cráneo-maxilofacial

Chirurgie crânio-maxillofaciale

Chirurgia cranio-maxillofaciale



1/2

Collin  
38-452-17-07  
17 cm / 6 5/8"



1/2

Young  
38-467-17-07  
15 cm / 5 7/8"

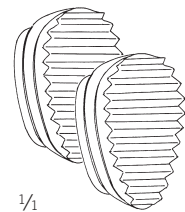

1/1

Young  
38-468-02-04  
Gummipolster  
Rubber Inserts  
Bocas de goma  
Mors en caoutchouc  
Cuscino di gomma

Paar  
pair  
par  
paire  
paio



38-467-17-07

## Intraorale Retraktoren

Intra Oral Retractors  
Separadores intra orales  
Rétracteurs intra-oraux  
Separatori intraorali

9,5/16 mm



38-501-24-01

22 cm / 8<sup>7</sup>/<sub>8</sub>"

konkav, stark aufgebogen  
concave, fully bent tip  
concave, courbé énormément  
conzáva, fuertemente curva  
concava, fortemente curva



Eckelt

38-502-24-01

21 cm / 8<sup>2</sup>/<sub>8</sub>"

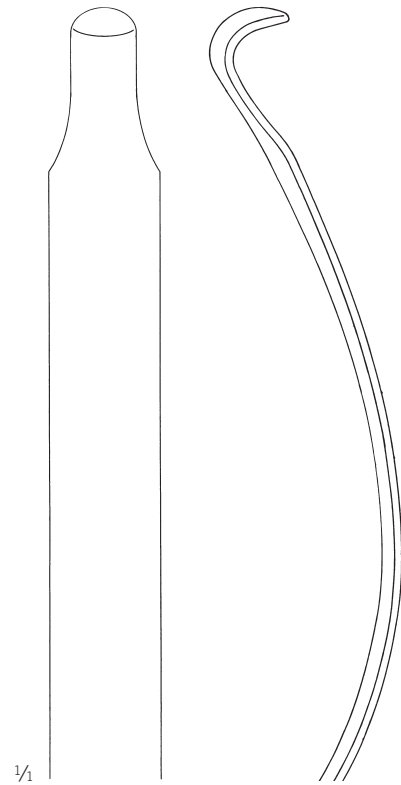

## Intraorale Retraktoren

Intra Oral Retractors  
Separadores intra orales  
Rétracteurs intra-oraux  
Separatori intraorali

## Kraniomaxillofaziale Chirurgie

Craniomaxillofacial surgery  
Cirugía cráneo-maxilofacial  
Chirurgie crânio-maxillofaciale  
Chirurgia cranio-maxillofaciale



9,5/16 mm



1/2

**38-503-27-01**

25 cm / 9 7/8"

konkav, stark aufgebogen  
concave, fully bent tip  
concáva, fuertemente curva  
concave, courbé énormément  
concava, fortemente curva



1/2

**Eckelt**

**38-504-27-01**

25 cm / 9 7/8"

konkav, stark aufgebogen  
concave, fully bent tip  
concáva, fuertemente curva  
concave, courbé énormément  
concava, fortemente curva

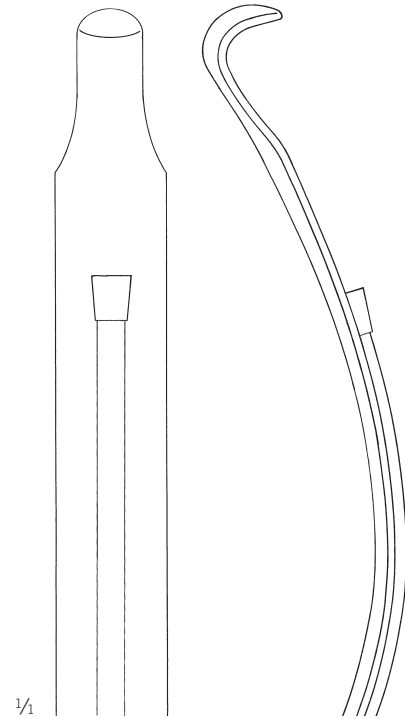

1/1

## Intraorale Retraktoren

Intra Oral Retractors  
Separadores intra orales  
Rétracteurs intra-oraux  
Separatori intraorali



38-505-24-01

23 cm / 9"

für LeFort Osteotomie  
for LeFort osteotomies  
para osteotomías según LeFort  
pour ostéotomie selon LeFort  
per osteotomie sec. LeFort  
**25,5 mm**



38-507-27-01

26 cm / 10 2/8"

für LeFort Osteotomie  
for LeFort osteotomies  
para osteotomías según LeFort  
pour ostéotomie selon LeFort  
per osteotomie sec. LeFort  
**25,5 mm**

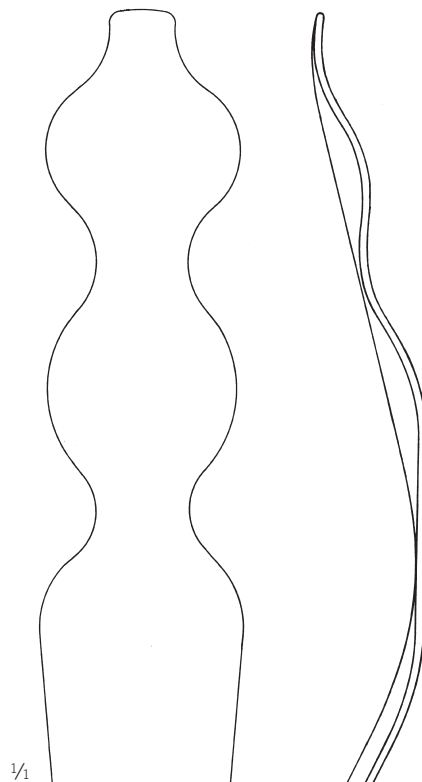



## Intraorale Retraktoren

Intra Oral Retractors  
Separadores intra-orales  
Rétracteurs intra-oraux  
Separatori intraorali

## Kraniomaxillofaziale Chirurgie

Craniomaxillofacial surgery  
Cirugía cráneo-maxilofacial  
Chirurgie crânio-maxillofaciale  
Chirurgia cranio-maxillofaciale

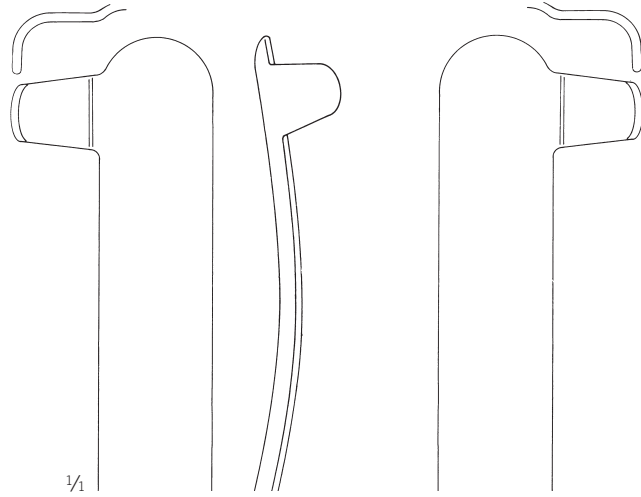

26,5 / 16 mm

26,5 / 16 mm

26,5 / 16 mm

26,5 / 16 mm



1/2

1/2

1/2

1/2

38-509-21-01

21 cm / 8 2/8"

rechts  
right  
derecho  
droit  
destra

38-511-21-01

21 cm / 8 2/8"

links  
left  
izquierdo  
gauche  
sinistra

38-513-24-01

24,5 cm / 9 5/8"

rechts  
right  
derecho  
droit  
destra



38-515-24-01

24,5 cm / 9 5/8"

links  
left  
izquierdo  
gauche  
sinistra



## Intraorale Retraktoren

Intra Oral Retractors

Separadores intra-orales

Rétracteurs intra-oraux

Separatori intraorali

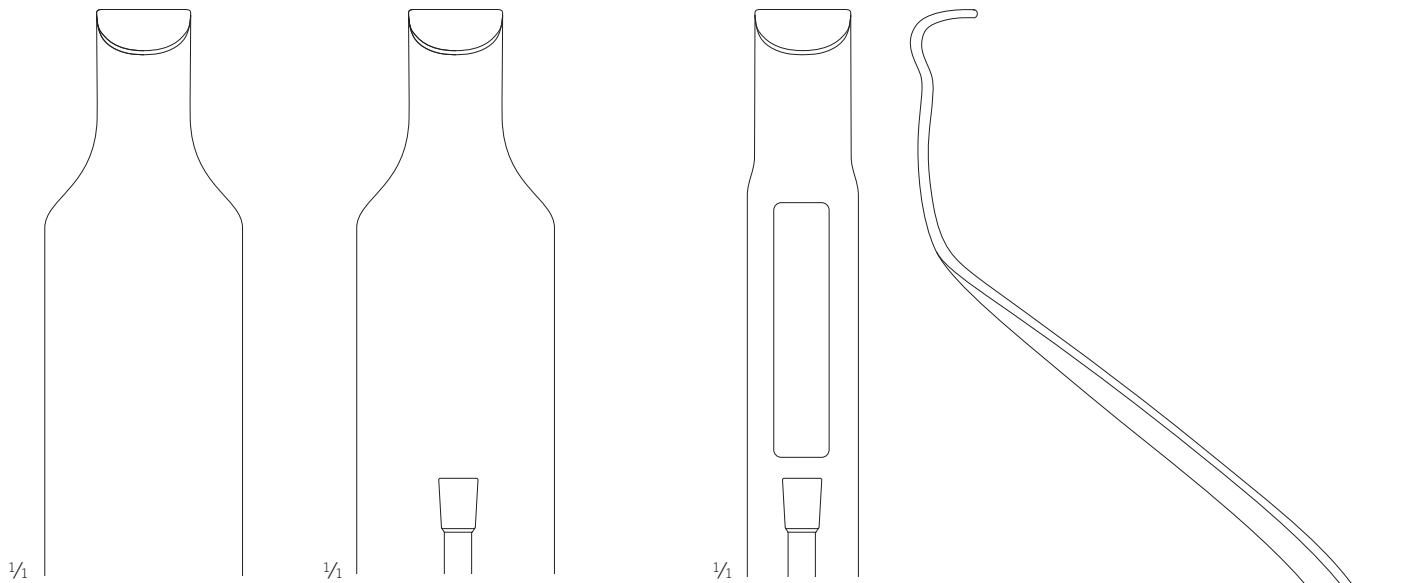

12,5 / 27 mm

12,5 / 27 mm

12,5 / 27 mm



1/2

**38-517-25-01**

25 cm / 9 7/8"

L&M, für vertikale Osteotomie  
L&M for vertical osteotomy  
L&M, para osteotomía vertical  
L&M, pour ostéotomie verticale  
L&M, per osteotomia verticale



1/2

**38-519-28-01**

28 cm / 11"

L&M, für vertikale Osteotomie  
L&M for vertical osteotomy  
L&M, para osteotomía vertical  
L&M, pour ostéotomie verticale  
L&M, per osteotomia verticale



1/2

**38-520-28-01**

28 cm / 11"

L&M, für vertikale Osteotomie, gefenestert  
L&M for vertical osteotomy, fenestrated  
L&M, para osteotomía vertical, fenestrada  
L&M, pour ostéotomie verticale, fenêtrée  
L&M, per osteotomia verticale, finestra



1/1

## Intraorale Retraktoren

Intra Oral Retractors  
Separadores intra-orales  
Rétracteurs intra-oraux  
Separatori intraorali

## Kraniomaxillofaziale Chirurgie

Craniomaxillofacial surgery  
Cirugía cráneo-maxilofacial  
Chirurgie crânio-maxillofaciale  
Chirurgia cranio-maxillofaciale

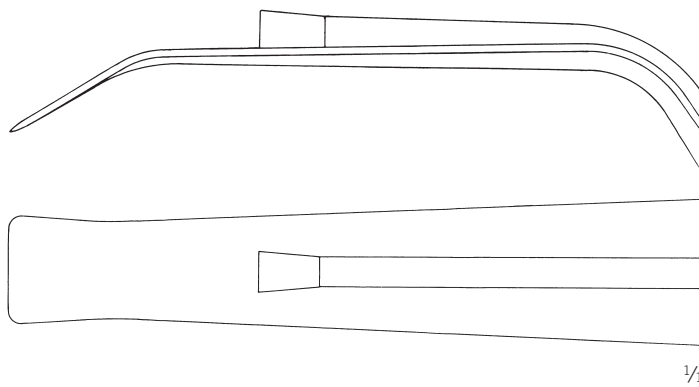

14,5 mm



1/2

Shea  
38-523-24-01

23,5 cm / 9 2/8"

Mehrzweck-Retraktor  
Multi purpose Retractor  
Separador de aplicaciones varias  
Rétracteur pour applications différentes  
Separatore multiuso



## Sagittale Ramusosteotomie nach Ishi

Sagittal ramus osteotomies acc. to Ishi

Osteotomía sagital de rama mandibular según Ishi

Ostéotomie sagittale du ramus selon Ishi

Osteotomia sagittale del ramo secondo Ishi

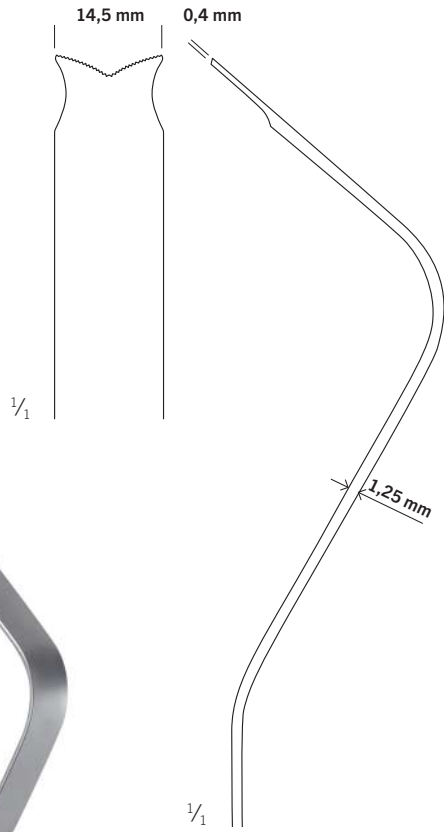

1/2

Ishi  
38-520-01-07  
23 cm / 9"

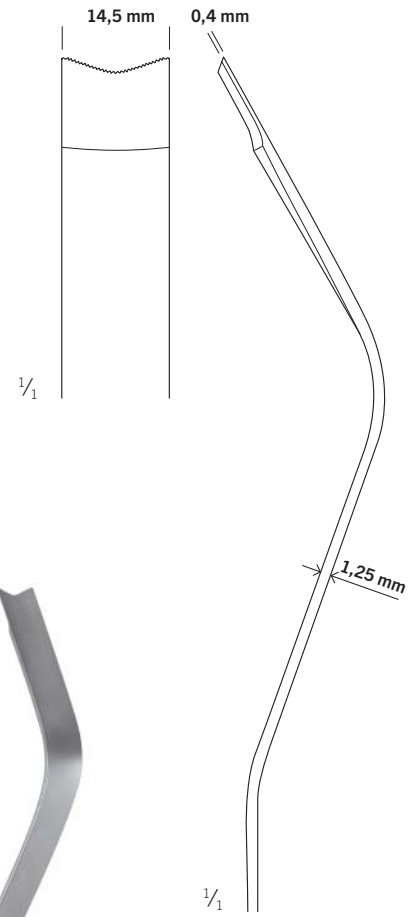

1/2

Ishi  
38-520-02-07  
24,5 cm / 9 5/8"

## Sagittale Ramusosteotomie nach Ishi

Sagittal ramus osteotomies acc. to Ishi  
Osteotomía sagital de rama mandibular según Ishi  
Ostéotomie sagittale du ramus selon Ishi  
Osteotomia sagittale del ramo secondo Ishi

## Kraniomaxillofaziale Chirurgie

Craniomaxillofacial surgery  
Cirugía cráneo-maxilofacial  
Chirurgie crânio-maxillofaciale  
Chirurgia cranio-maxillofaciale

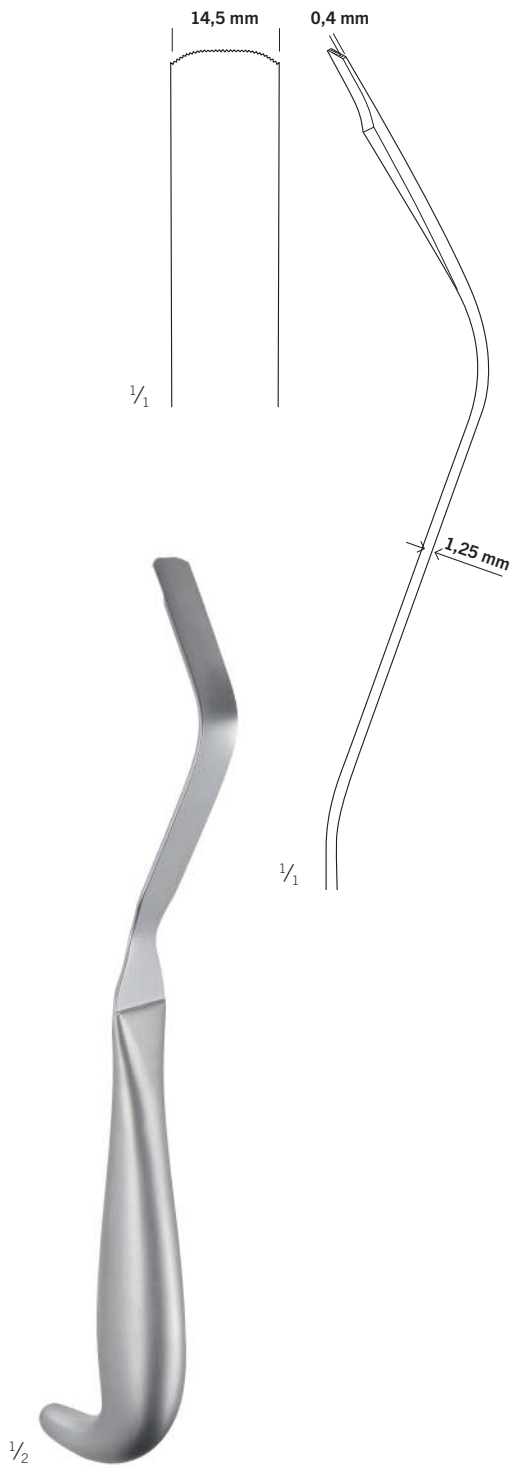

Ishi  
38-520-03-07  
24 cm / 9 4/8"



Ishi  
38-520-04-07  
19,5 cm / 7 5/8"

## Intraorale Retraktoren

Intra Oral Retractors

Separadores intra orales

Rétracteurs intra-oraux

Separatori intraorali

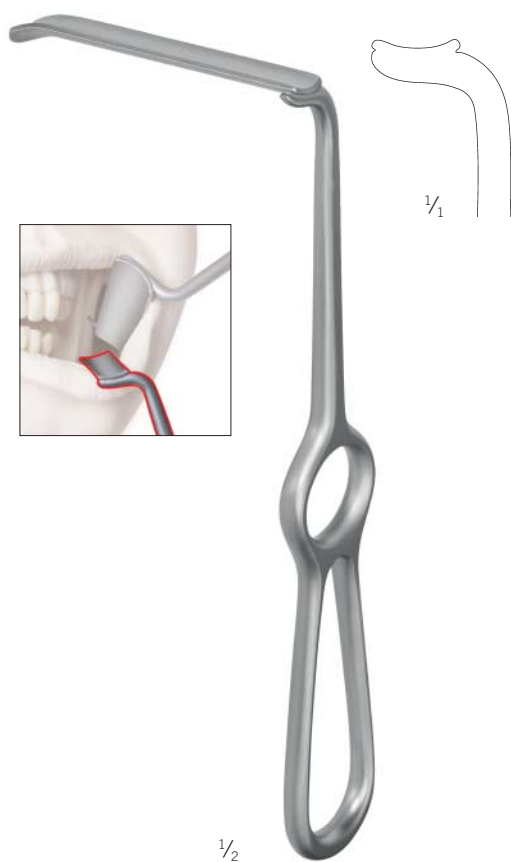
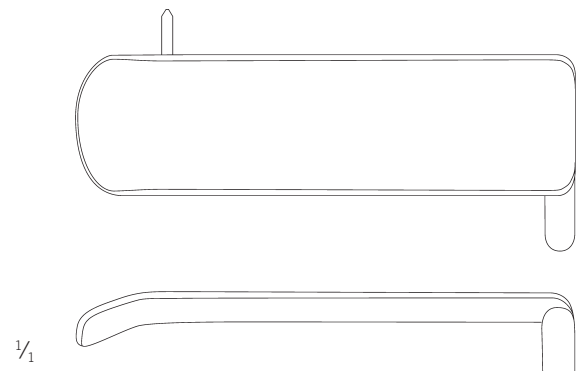
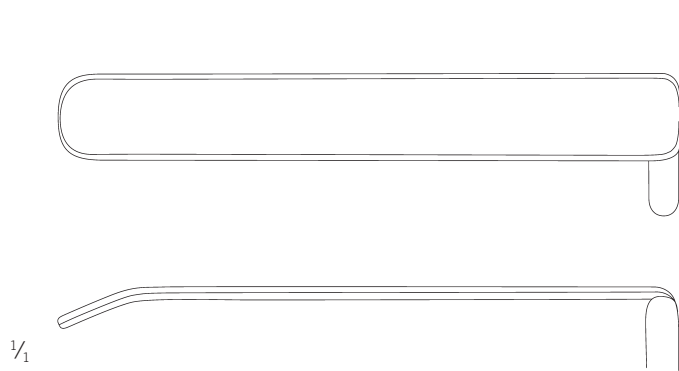

1/2

Lindorf  
38-525-01-07

19,5 cm / 7 5/8"

Side-Step-Haken, links unten

Side-step retractor, left-side, lower region

Side-step retractor, left-side, lower region

Separador tipo "side-step", lado izquierdo, región inferior

Rétracteur «side-step», côté gauche, région inférieure

Retrattore "side-step", lato sinistro, regione inferiore

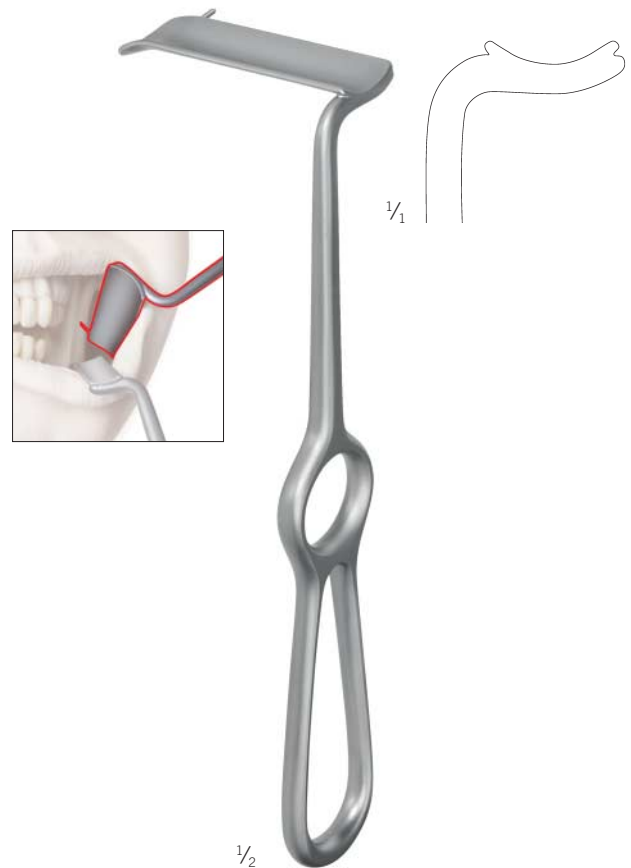

1/2

Lindorf  
38-526-01-07

19,5 cm / 7 5/8"

Ramus-Krallenhaken, links oben

Hook-type ramus retractor, left-side, upper region

Separador de rama mandibular tipo garra,

lado izquierdo, región superior

Rétracteur à crochet pour ramus, côté gauche,

région supérieure

Retrattore ad uncino per ramo, lato sinistro,

regione superiore

## Intraorale Retraktoren

Intra Oral Retractors  
Separadores intra orales  
Rétracteurs intra-oraux  
Separatori intraorali

## Kraniomaxillofaziale Chirurgie

Craniomaxillofacial surgery  
Cirugía cráneo-maxilofacial  
Chirurgie crânio-maxillofaciale  
Chirurgia cranio-maxillofaciale

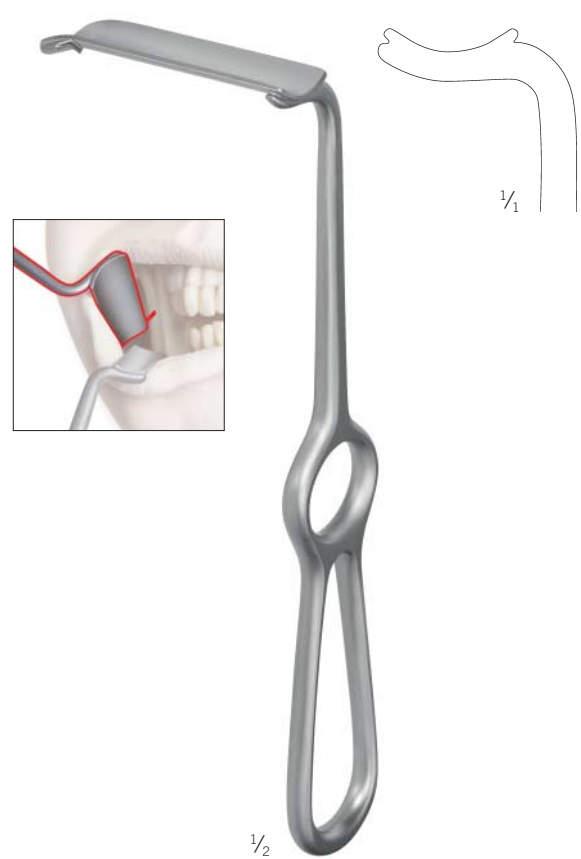
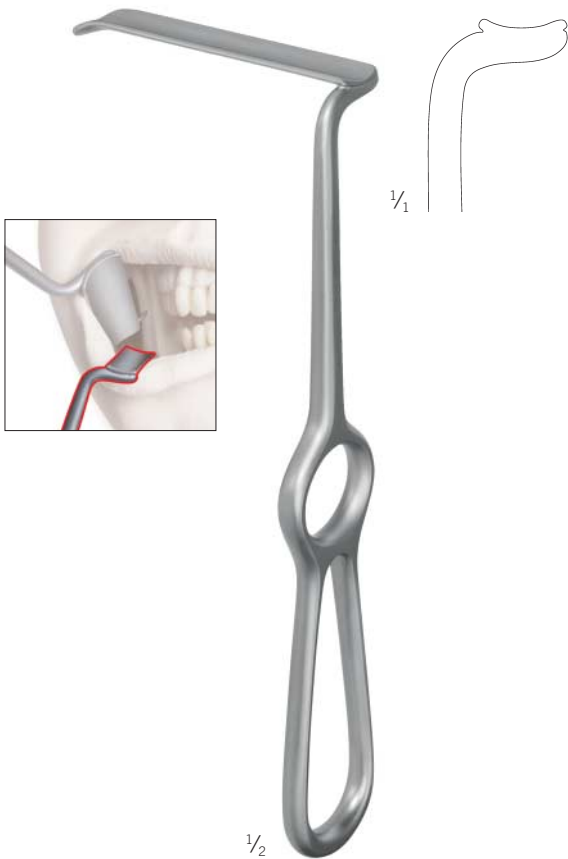
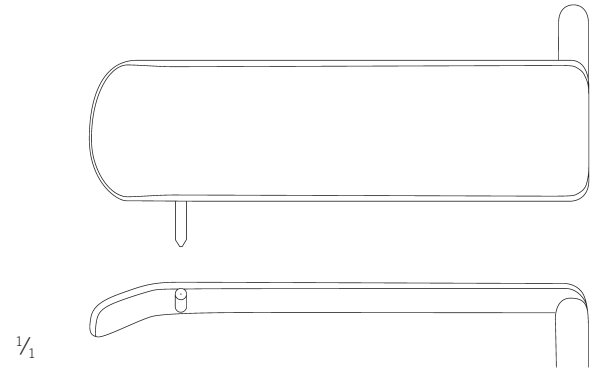
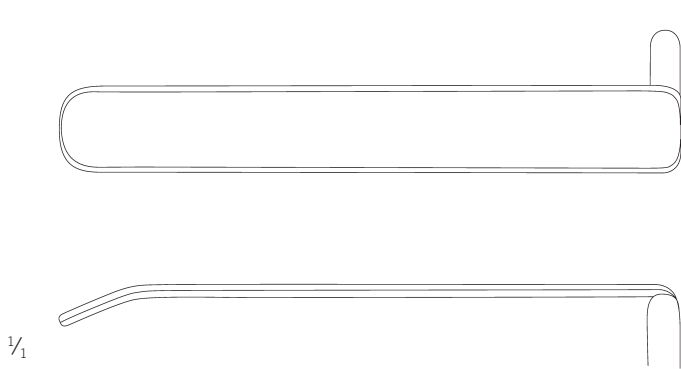

Lindorf  
38-525-02-07  
19,5 cm / 7 5/8"

Side-Step-Haken, rechts unten  
Side-step retractor, right-side, lower region  
Separador tipo "side-step", lado derecho, región inferior  
Rétracteur «side-step», côté droit, région inférieure  
Retrattore "side-step", lato destro, regione inferiore

Lindorf  
38-526-02-07  
19,5 cm / 7 5/8"

Ramus-Krallenhaken, rechts oben  
Hook-type ramus retractor, right-side, upper region  
Separador de rama mandibular tipo garra,  
lado derecho, región superior  
Rétracteur à crochet pour ramus, côté droit,  
région supérieure  
Retrattore ad uncino per ramo, lato destro,  
regione superiore

## Sinus-Krallenhaken nach Lindorf

Sinus-Krallenhaken acc. to Lindorf

Separador-garra sinus según Lindorf

Retracteur sinus griffe selon Lindorf

Divaricatore-artiglio sinus secondo Lindorf



Lindorf  
38-527-01-07

19,5 cm / 7 5/8"

Sinus-Krallenhaken, links  
Sinus claw retractor, left  
Separador-garra sinus, izquierda  
Retracteur sinus griffe, gauche  
Divaricatore-artiglio sinus, sinistra



Lindorf  
38-527-02-07

19,5 cm / 7 5/8"

Sinus-Krallenhaken, rechts  
Sinus claw retractor, right  
Separador-garra sinus, derecha  
Retracteur sinus griffe, droite  
Divaricatore-artiglio sinus, destra



## Weichteilhaken

Soft Tissue Retractors  
Separadores para partes blandas  
Crochets pour parties molles  
Separatori per tessuti molli

## Kraniomaxillofaziale Chirurgie

Craniomaxillofacial surgery  
Cirugía cráneo-maxilofacial  
Chirurgie crânio-maxillofaciale  
Chirurgia cranio-maxillofaciale

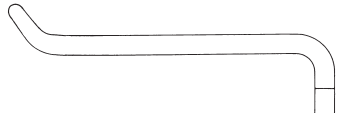

38-603-40-07

22,5 cm / 8 7/8"

43 x 11 mm

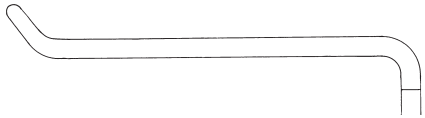

38-603-55-07

23 cm / 9"

57 x 11 mm

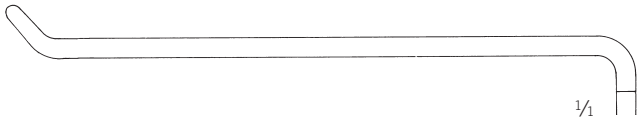

38-603-80-07

23 cm / 9"

80 x 16 mm

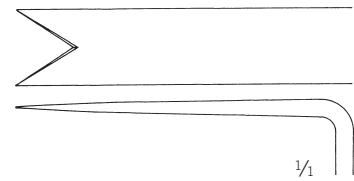

43 x 10 mm



1/2

Obwegeser  
38-603-40-07 -  
38-603-80-07



1/2

Obwegeser  
38-605-22-07  
22 cm / 8 5/8"

Spina nasalis-Haken  
Nasal Spine Retractor  
Separador para spina nasalis  
Ecarteur pour spina nasalis  
Separatore per spina nasale

## Ramushaken, Kinnhalter, Progenierinnen

Ramus Retractors, Chin Retractor, Channel Retractors

Separadores para el ramo, Gancho de mentón, Separadores mandibulares

Ecarteurs pour ramus, Fixe-menton, Écarteurs mandibulaires

Separatore per ramo, Guancio per mento, Separatori mandibulari

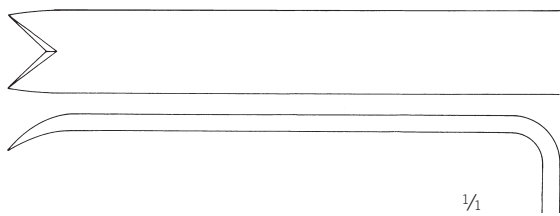

72 x 10 mm



1/2

Obwegeser  
38-607-22-07  
22 cm / 8 5/8"



1/2

Obwegeser  
38-611-16-07  
16,5 cm / 6 4/8"



1/2

Obwegeser  
38-613-08-07 -  
38-613-10-07

38-613-08-07  
16 cm / 6 2/8"  
**8 mm**

38-613-10-07  
16 cm / 6 2/8"  
**10 mm**

## Progeniehaken

Progeny Retractor  
Separadores para progenismo  
Crochets de progenie  
Separatori per progenismo

## Kraniomaxillofaziale Chirurgie

Craniomaxillofacial surgery  
Cirugía cráneo-maxilofacial  
Chirurgie crânio-maxillofaciale  
Chirurgia cranio-maxillofaciale

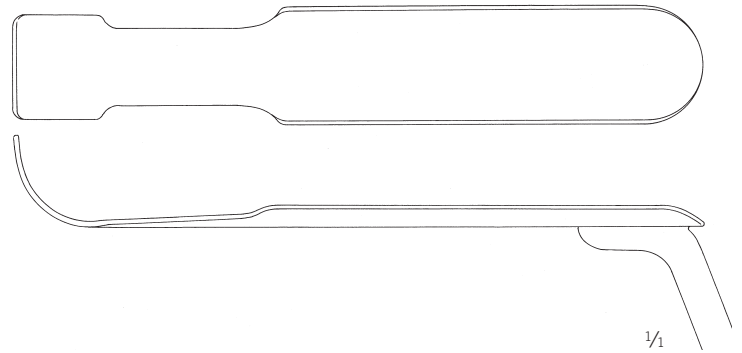
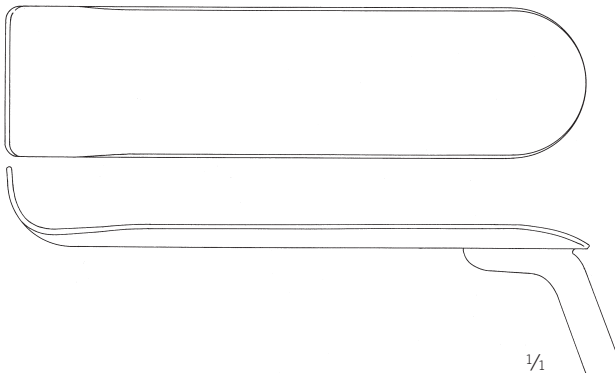

1/2

Schuchardt  
38-614-10-07  
18 cm / 7 1/8"



1/2

Metz  
38-614-20-07  
19,5 cm / 7 5/8"

## Wundhaken

Retractors  
Separadores  
Ecarteurs  
Divaricatori



38-616-01-07 -  
38-616-02-07  
18 cm / 7 1/8"

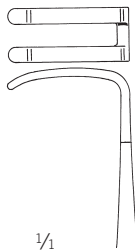

Koberg  
38-616-01-07  
15 x 7 mm

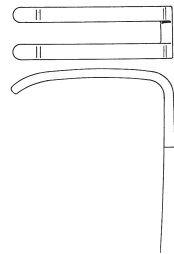

Koberg, mod.  
38-616-02-07  
20 x 7 mm

## Progeniehaken

Progeny Retractor  
Separadores para progenismo  
Crochets de progenie  
Separatori per progenismo

## Kraniomaxillofaziale Chirurgie

Craniomaxillofacial surgery  
Cirugía cráneo-maxilofacial  
Chirurgie crânio-maxillofaciale  
Chirurgia cranio-maxillofaciale

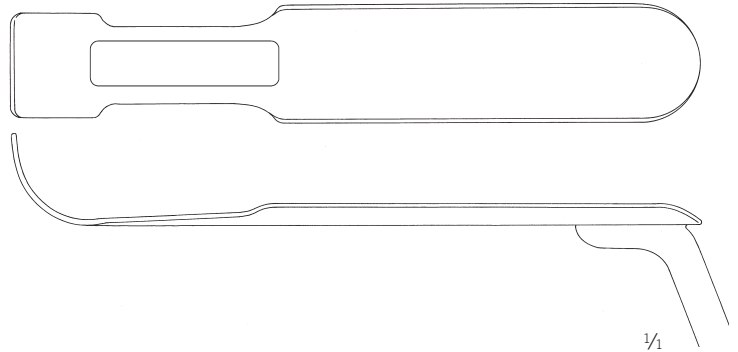
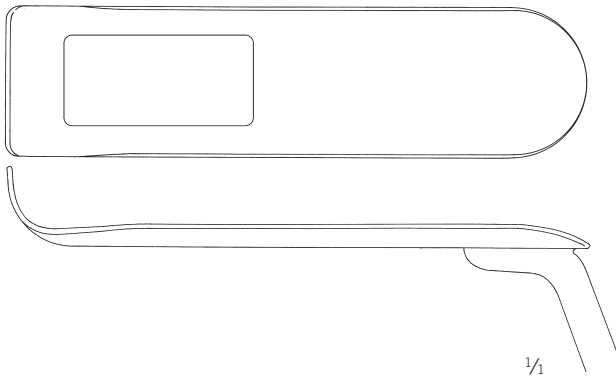

Schuchardt-Lauer  
38-616-10-07  
15 cm / 5 7/8"



Metz-Lauer  
38-616-20-07  
15 cm / 5 7/8"

## Raspatorien

Periosteal Elevators

Legras

Rugines-raspatoires

Elevatori per periosteo

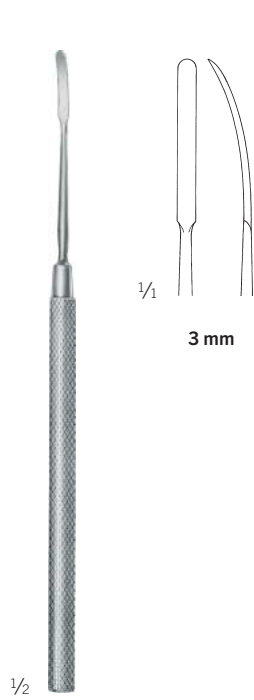

38-618-01-07  
18 cm / 7 1/8"

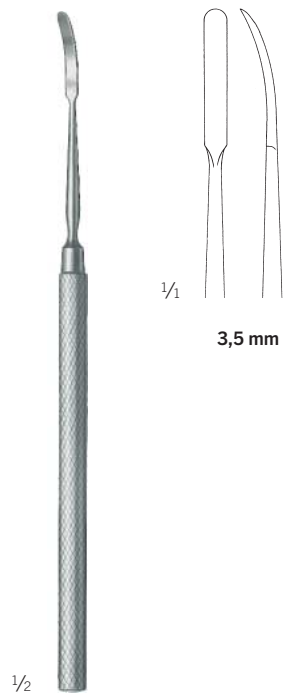

38-618-02-07  
18 cm / 7 1/8"

## Progeniehaken

Progeny Retractor  
Separadores para progenismo  
Crochets de progenie  
Separatori per progenismo

## Kraniomaxillofaziale Chirurgie

Craniomaxillofacial surgery  
Cirugía cráneo-maxilofacial  
Chirurgie crânio-maxillofaciale  
Chirurgia cranio-maxillofaciale

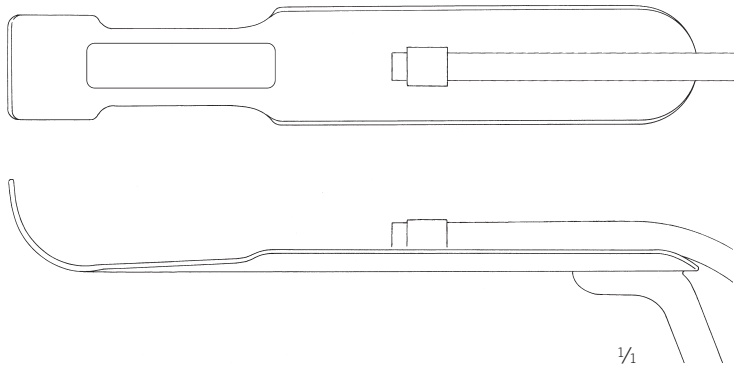
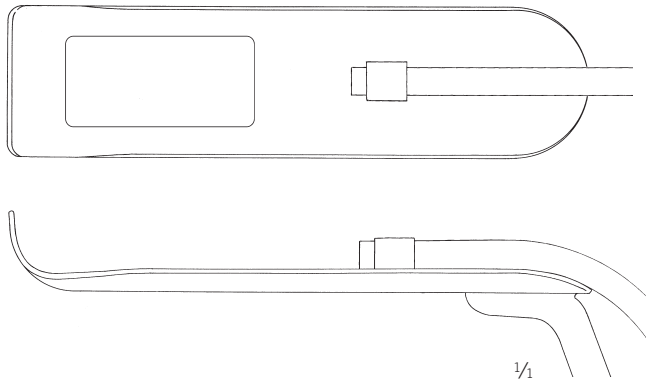

1/2

Schuchardt-Lauer  
38-618-10-07  
15 cm / 5 7/8"



1/2

Metz-Lauer  
38-618-20-07  
15 cm / 5 7/8"



## Progeniehaken

Progeny Retractor

Separadores para progenismo

Crochets de progenie

Separatori per progenismo

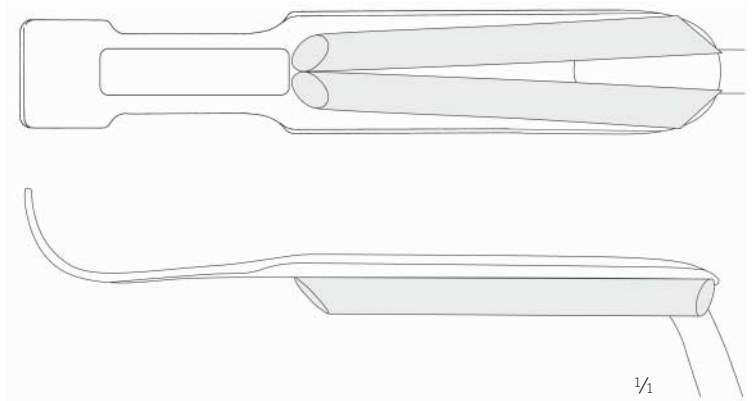
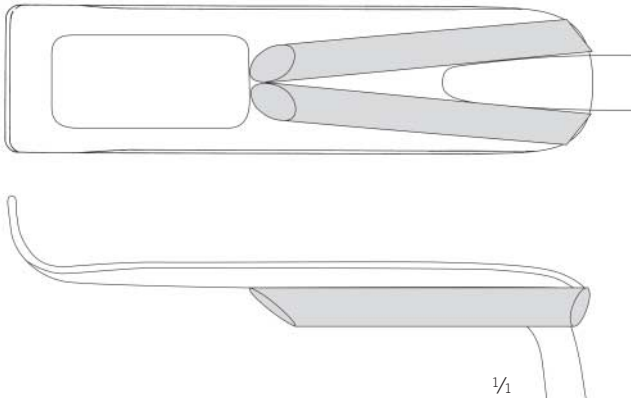

Schuchardt-Lauer  
38-620-10-07  
20 cm / 7 7/8"



Metz-Lauer  
38-620-20-07  
20 cm / 7 7/8"



## Raspatorien

Periosteal Elevators  
Periostótomos  
Rugines-raspatoires  
Periostotomi

## Kraniomaxillofaziale Chirurgie

Craniomaxillofacial surgery  
Cirugía cráneo-maxilofacial  
Chirurgie crânio-maxillofaciale  
Chirurgia cranio-maxillofaciale

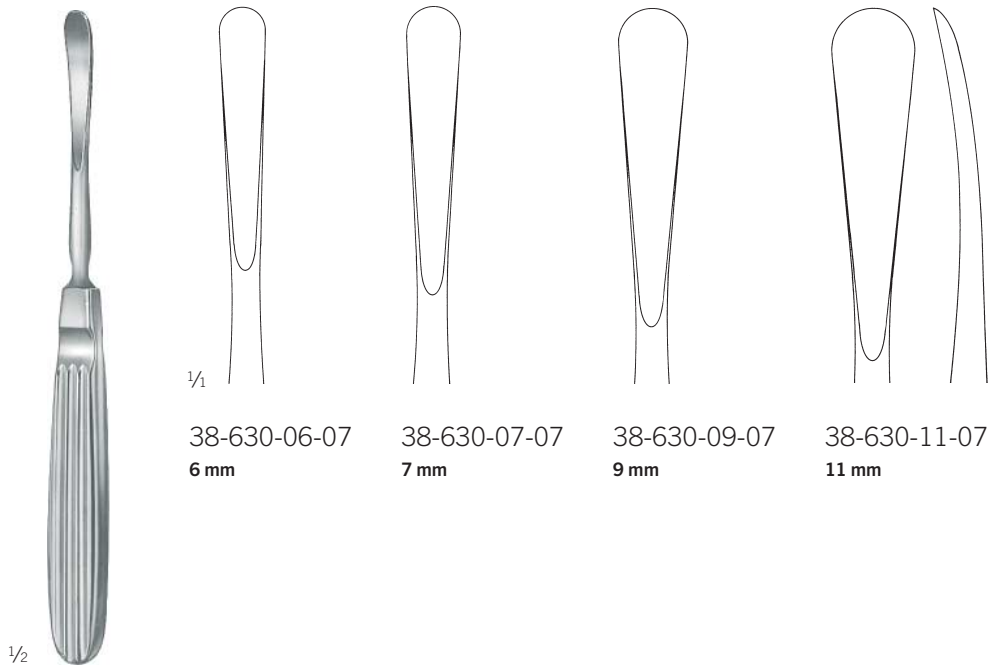

1/4

38-630-06-07  
6 mm

38-630-07-07  
7 mm

38-630-09-07  
9 mm

38-630-11-07  
11 mm

1/2

### Obwegeser

38-630-06-07 - 38-630-11-07

17,5 cm / 6 7/8"



1/4

38-631-05-07  
5 mm

38-631-07-07  
7 mm

38-631-09-07  
9 mm

1/2

### Obwegeser

38-631-05-07 - 38-631-09-07

20 cm / 7 7/8"

## Raspatorien

Periosteal Elevators  
 Periostótomos  
 Rugines-raspatoires  
 Periostotomi



1/2



38-632-01-07



38-632-02-07

1/1

### Obwegeser

38-632-01-07 - 38-632-02-07

17,5 cm / 6 7/8"



1/2



38-633-01-07

Periostelevatorium  
 Periosteal Elevator  
 Legra  
 Rugine-raspatoire  
 Elevatore per periosteo



38-633-02-07

Periostelevatorium  
 Periosteal Elevator  
 Legra  
 Rugine-raspatoire  
 Elevatore per periosteo

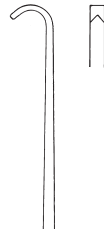

Fig. 11

38-633-03-07

Gelenkpositionierer  
 Condylar Repositioning Instrument  
 Instrumento para reposicion condylar  
 Repositionneur pour articul. mahoire  
 Strumento di riposizionamento condilare



Fig. 12

38-633-04-07

1/1

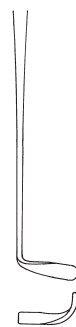
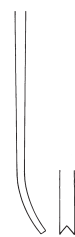

### Krenkel

38-633-01-07 - 38-633-04-07

24,5 cm / 9 5/8"

## Elevatoren, Drahtpositionierer, Drahtbogen

Elevators, Wire Pushers  
 Elevadores, Empujadores de alambres  
 Elévateurs, Outil de positionnement  
 Elevatori, Posizionatori per filo

## Kraniomaxillofaziale Chirurgie

Craniomaxillofacial surgery  
 Cirugía cráneo-maxilofacial  
 Chirurgie crânio-maxillofaciale  
 Chirurgia cranio-maxillofaciale



Obwegeser  
 38-640-21-07  
 20,5 cm / 8 1/8"



Obwegeser  
 38-642-21-07  
 20,5 cm / 8 1/8"



38-685-00-07  
 17 cm / 6 5/8"



Rowe  
 38-688-15-07  
 15 cm / 5 7/8"



Erich  
 38-690-00-07  
 Gesamtlänge  
 Overall length  
 Longitud total  
 Longueur totale  
 Lunghezza complessiva  
**1 m**

## Elevatoren, Drahtpositionierer, Drahtbogen

Elevators, Wire Pushers

Elevadores, Empujadores de alambres

Elévateurs, Outil de positionnement

Elevatori, Posizionatori per filo

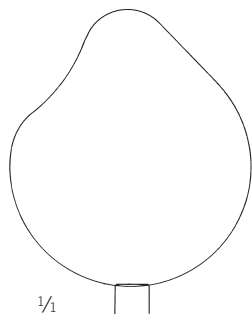

38-691-01-07

rechts  
right  
derecho  
droit  
destra

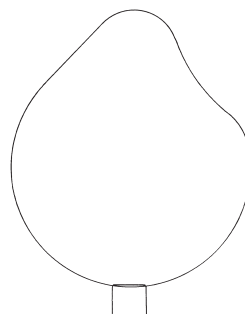

38-691-02-07

links  
left  
izquierdo  
gauche  
sinistra

Rowe  
38-691-01-07 -  
38-691-02-07  
19 cm / 7 1/8"

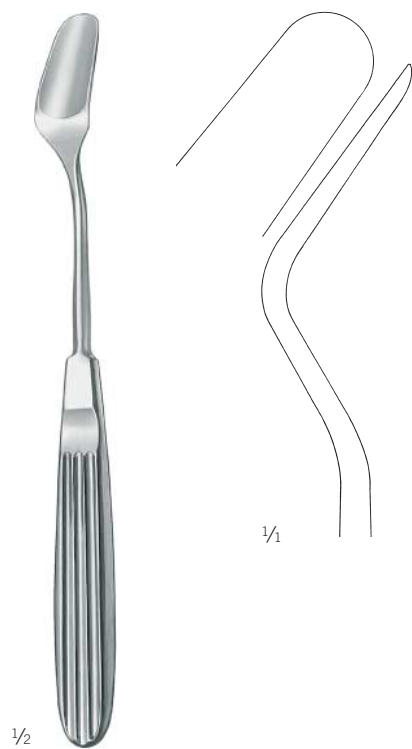

38-693-19-07  
20 cm / 7 7/8"

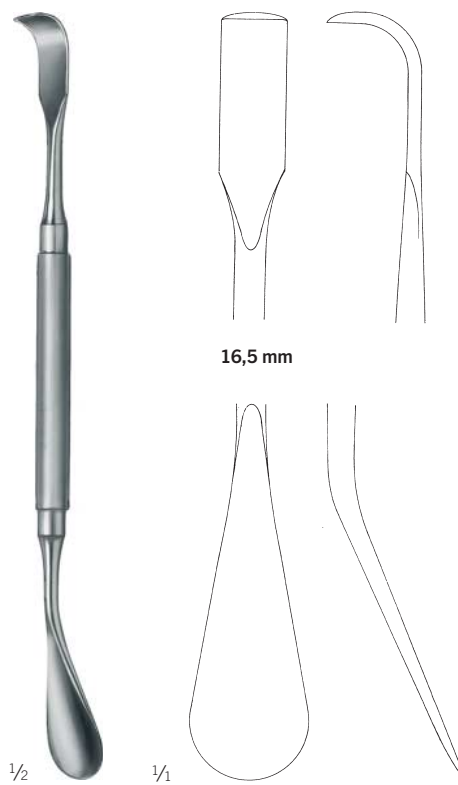

Donovan  
38-694-20-07  
19,5 cm / 7 5/8"

## Orbita-Instrumente

Orbita Instruments  
Instrumentos para Orbita  
Instruments pour Orbita  
Instruments per Orbita

## Kraniomaxillofaziale Chirurgie

Craniomaxillofacial surgery  
Cirugía cráneo-maxilofacial  
Chirurgie crânio-maxillofaciale  
Chirurgia cranio-maxillofaciale



1/2

38-695-20-07

20 cm / 7 7/8"

Orbita-Reaktor, links  
Orbital retractor, left  
Retractor orbital, izquierda  
Rétracteur orbital, gauche  
Separatore per orbita, sinistra



1/2

38-696-20-07

20 cm / 7 7/8"

Orbita-Reaktor, rechts  
Orbital retractor, right  
Retractor orbital, derecha  
Rétracteur orbital, droit  
Separatore per orbita, destra



1/2

38-697-01-07

20 cm / 7 7/8"

Spatel, orbital, gerade, biegsam,  
2 verschiedene Arbeitsenden  
Spatula, orbital, straight, malleable,  
2 different working ends  
Espátula, orbital, recta, maleable,  
2 extremos de trabajo diferentes  
Spatule, orbitale, droite, malléable,  
2 extrémités de travail différentes  
Spatola, orbitale, diritta, malleabile,  
2 diverse estremità di lavoro

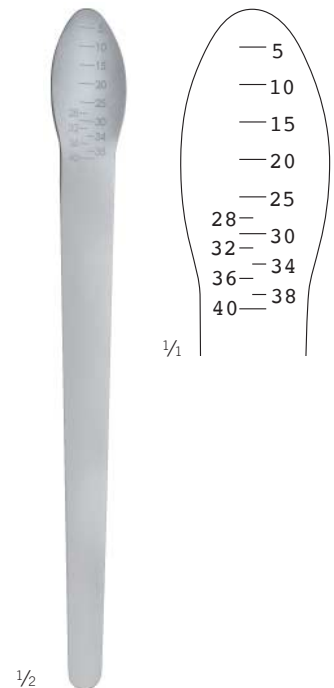

1/2

38-697-02-07

18 cm / 7 1/8"

Spatel, orbital, gerade, biegsam  
Spatula, orbital, straight, malleable  
Espátula, orbital, recta, maleable  
Spatule, orbitale, droite, malléable  
Spatola, orbitale, diritta, malleabile

## Repositionszangen

Disimpaction Forceps

Pinzas para reposición

Pinces de reposition

Pinze per riduzione

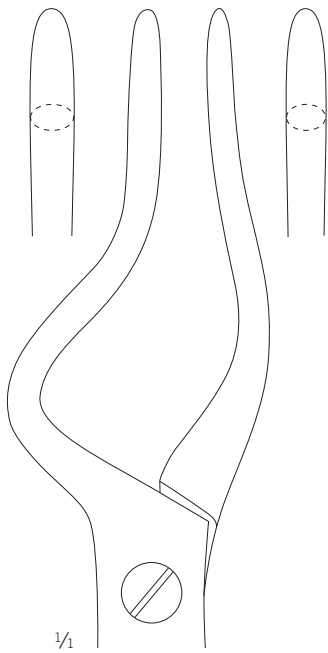

38-700-01-07 **L**  
38-701-01-07 **R**  
21,5 cm / 8<sup>4</sup>/<sub>8</sub>"

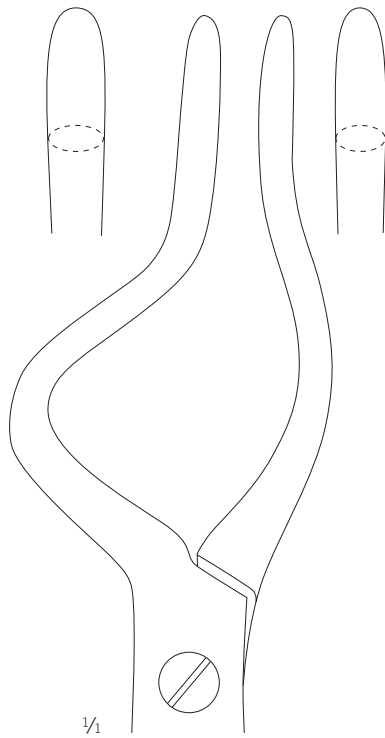

38-700-02-07 **L**  
38-701-02-07 **R**  
24 cm / 9<sup>4</sup>/<sub>8</sub>"

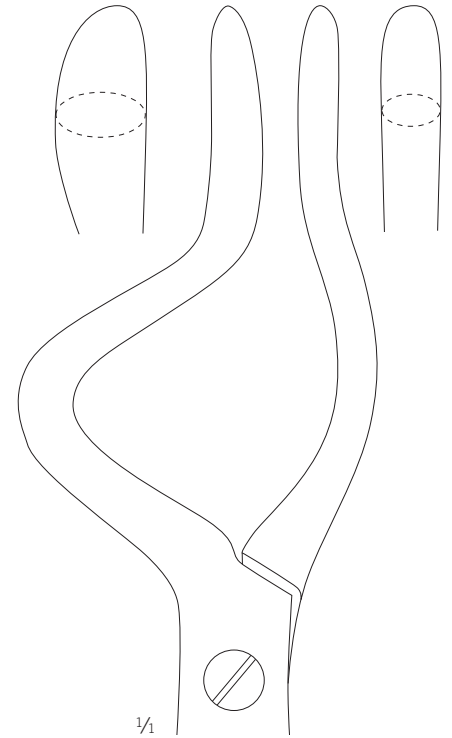

38-700-03-07 **L**  
38-701-03-07 **R**  
24,5 cm / 9<sup>5</sup>/<sub>8</sub>"



Rowe  
**L**  
links  
left  
izquierdo  
gauche  
sinistra



Rowe  
**R**  
rechts  
right  
derecho  
droit  
destra

## Zygoma-Elevatorien

Zygoma Elevators  
Elevadores cigomáticos  
Elévateurs zygomatiques  
Elevatori per zigomo

## Kraniomaxillofaziale Chirurgie

Craniomaxillofacial surgery  
Cirugía cráneo-maxilofacial  
Chirurgie crânio-maxillofaciale  
Chirurgia cranio-maxillofaciale



1/2

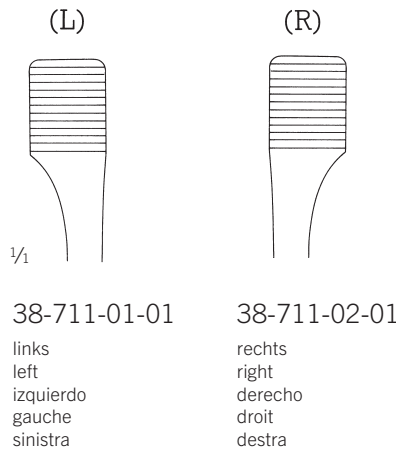

## Tessier

38-711-01-01 - 38-711-02-01

Mobilisierhaken  
Maxillary Mobilizer  
Gancho para movilización  
Mobilisateur  
Gancio per mobilizzare



1/1

Spitze  
tip  
punta  
pointe  
punta  
**Ø 5,0 mm**



38-711-21-07  
25 cm / 9 6/8"

1/2



Dingmann  
38-713-21-07  
21,5 cm / 8 4/8"

1/2

## Haken, Knochenhaltezeugen

Hooks, Bone Holding Forceps

Ganchos, Pinzas para huesos

Ecarteurs, Pincers pour os

Divaricatori, Pinze per ossa



Dingmann-Wilk  
38-715-19-07

20 cm / 7 7/8"



Eckelt  
38-715-21-07

20 cm / 7 7/8"

Plattenzuginstrument  
Plate-pulling Instrument  
Pinaz agarre para placas  
Crochet our maintenir plaque  
Strumento per riposizionamento placche



Jeter-Van Sickle

38-718-01-07 -  
38-718-02-07

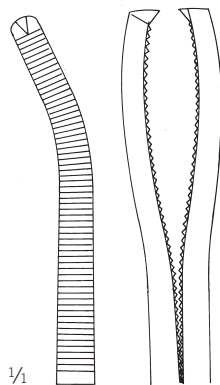

38-718-01-07

19 cm / 7 4/8"

leichtes Modell, für sagittalen Split  
light pattern, for sagittal split procedure  
modelo ligero, para uso en el sagital split  
modèle léger, pour fente sagittale  
modello leggero, per uso dell'osteotomia sagittale



1:2

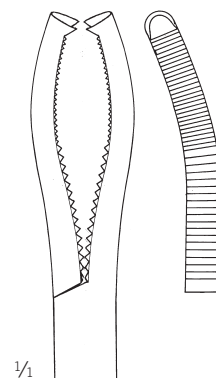

38-718-02-07

18 cm / 7 1/8"

kräftiges Modell, für sagittalen Split  
heavy pattern, for sagittal split procedure  
modelo fuerte, para uso en el sagital split  
modèle fort, pour fente sagittale  
modello pesante, per uso dell'osteotomia sagittale



2:2



## Knochenhaltezangen

Bone Holding Forceps

Pinzas para huesos

Pinces pour os

Pinze per ossa

## Kraniomaxillofaziale Chirurgie

Craniomaxillofacial surgery

Cirugía cráneo-maxilofacial

Chirurgie crânio-maxillofaciale

Chirurgia cranio-maxillofaciale



1/2

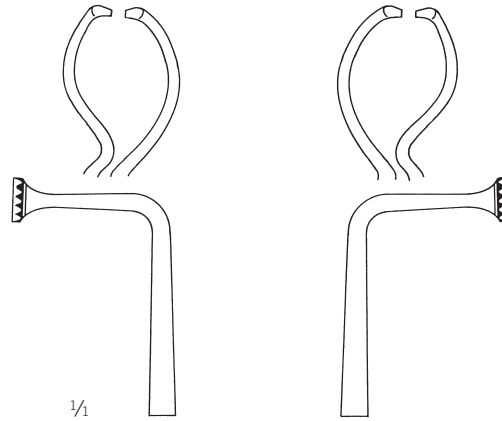

1/1

38-719-01-07

links  
left  
izquierdo  
gauche  
sinistra

38-719-02-07

rechts  
right  
derecho  
droit  
destra

Keen  
38-719-01-07 -  
38-719-02-07  
17,5 cm / 6 7/8"



1/2

Steinhäuser  
38-720-01-07  
13,5 cm / 5 3/8"



1/2

Steinhäuser  
38-720-02-07  
12,5 cm / 4 7/8"

## Knochenhaltezangen

Bone Holding Forceps

Pinzas para huesos

Pinces pour os

Pinze per ossa

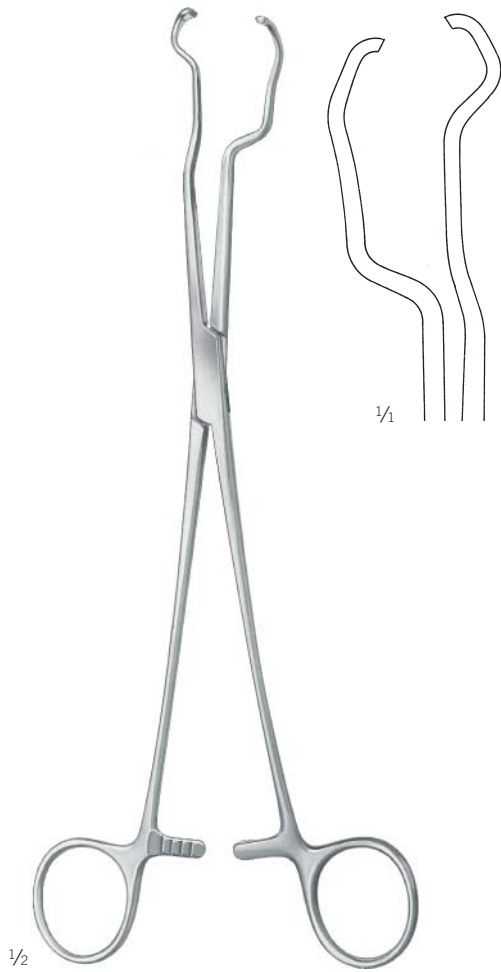

Wolford  
38-722-25-07  
25 cm / 9 7/8"

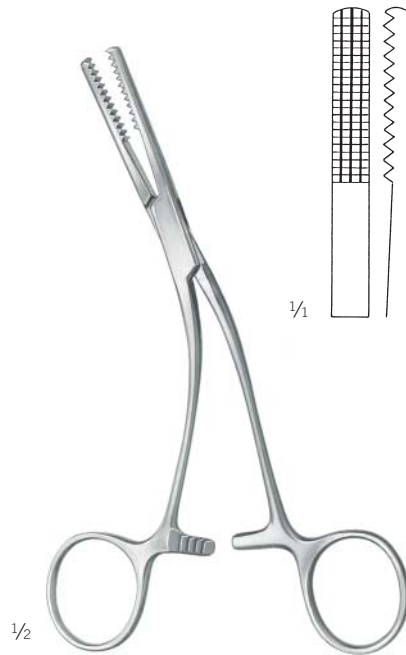

Salyer  
38-723-16-07  
16,5 cm / 6 4/8"

## Instrumente für TMJ

Instruments for TMJ  
Instrumentos para TMJ  
Instruments pour TMJ  
Instruments per TMJ

## Kraniomaxillofaziale Chirurgie

Craniomaxillofacial surgery  
Cirugía cráneo-maxilofacial  
Chirurgie crânio-maxillofaciale  
Chirurgia cranio-maxillofaciale



6,5 x 50 mm

1/2  
Dunn-Dautrey  
38-725-01-07  
16 cm / 6 2/8"  
Posterior retractor



6,5 x 60 mm

1/2  
Dunn-Dautrey  
38-725-02-07  
16 cm / 6 2/8"  
Anterior retractor



8,0 x 50 mm

1/2  
Dunn-Dautrey  
38-725-03-07  
16 cm / 6 2/8"  
Superior retractor



6,5 x 50 mm

1/2  
Dunn-Dautrey  
38-725-04-07  
16 cm / 6 2/8"  
Superior retractor

## Instrumente für TMJ

Instruments for TMJ  
Instrumentos para TMJ  
Instruments pour TMJ  
Instruments per TMJ

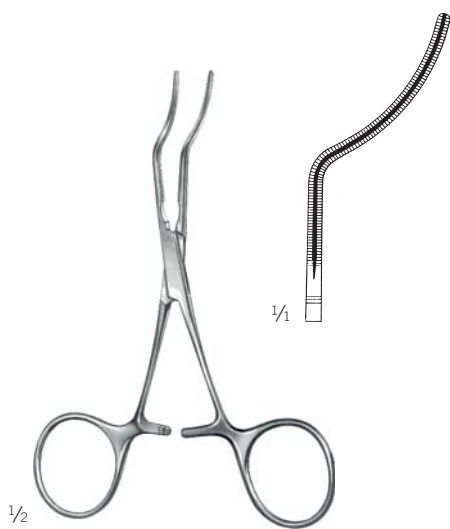

Dolwick  
38-731-12-07

12,5 cm / 4 7/8"

TMJ-Disc-Klemme  
TMJ Disc Forceps  
Pinaz para ATM  
Pince mâchoire  
Pinza snodo mascella

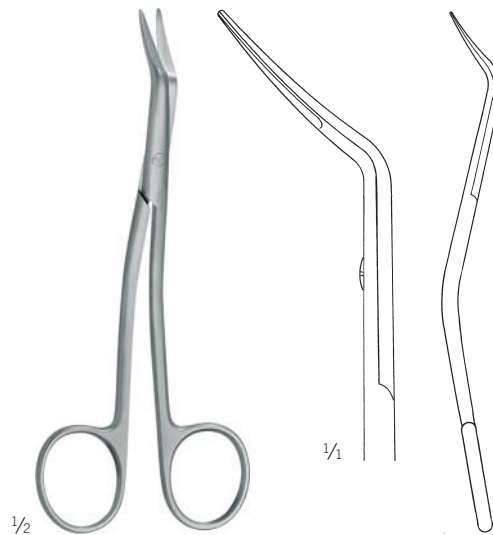

Dolwick  
38-733-13-07

13,5 cm / 5 3/8"

TMJ-Disc-Schere  
TMJ Disc Scissors  
Tijersa para ATM  
Ciseaux mâchoire  
Forbice snodo mascella



Dolwick  
38-737-17-07

17 cm / 6 6/8"

TMJ-Elevatorium  
TMJ-Elevator  
Elevador para ATM  
Elevateur pour TMJ  
Elevatore per TMJ



Dolwick  
38-739-14-07

14,5 cm / 5 6/8"

TMJ-Kondylenhaken  
TMJ Condyle Hook  
Gancho para condilos ATM  
Crochet condyle mâchoire  
Divaricatore per Condilo

## Instrumente für TMJ

Instruments for TMJ  
Instrumentos para TMJ  
Instruments pour TMJ  
Instruments per TMJ

## Kraniomaxillofaziale Chirurgie

Craniomaxillofacial surgery  
Cirugía cráneo-maxilofacial  
Chirurgie crânio-maxillofaciale  
Chirurgia cranio-maxillofaciale



1/2

1/1

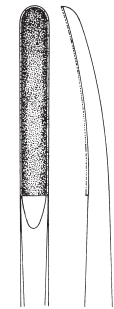

38-741-01-07  
15 cm / 5 7/8"

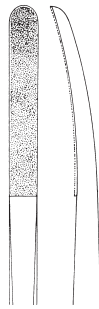

38-741-02-07  
15 cm / 5 7/8"

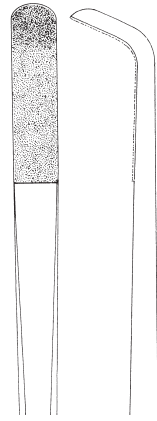

38-741-03-07  
17,5 cm / 6 7/8"

Dolwick  
38-741-01-07 -  
38-741-03-07

TMJ-Raspel  
TMJ-Rasp  
Escofina para ATM  
Râpe pour TMJ  
Raspa per TMJ

## Instrumente für TMJ

Instruments for TMJ  
Instrumentos para TMJ  
Instruments pour TMJ  
Instrumenti per TMJ



1/2

Dolwick  
38-745-01-07  
16 cm / 6 2/8"  
TMJ-Klemme  
TMJ-Forceps  
Pinza para ATM  
Pinze pour TMJ  
Pinza per TMJ



1/2

Dolwick  
38-745-02-07  
16,5 cm / 6 4/8"  
TMJ-Klemme  
TMJ-Forceps  
Pinza para ATM  
Pinze pour TMJ  
Pinza per TMJ

## Instrumente für TMJ

Instruments for TMJ  
Instrumentos para TMJ  
Instruments pour TMJ  
Instruments per TMJ

## Kraniomaxillofaziale Chirurgie

Craniomaxillofacial surgery  
Cirugía cráneo-maxilofacial  
Chirurgie crânio-maxillofaciale  
Chirurgia cranio-maxillofaciale



Champy  
38-750-16-07

16 cm / 6 2/8"  
TMJ-Spreizer  
TMJ-Spreader  
Separador para ATM  
Ecarteur pour TMJ  
Divaricatore per TMJ

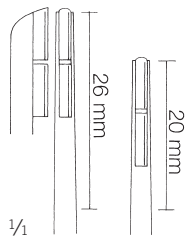
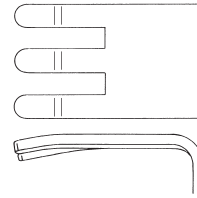
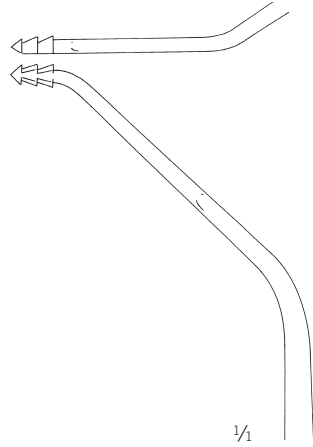

38-751-01-07

links  
left  
izquierdo  
gauche  
sinistra

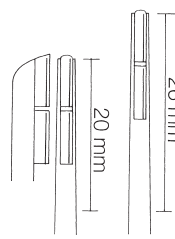

38-751-02-07

rechts  
right  
derecho  
droit  
destra

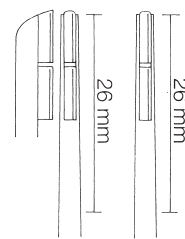

38-751-03-07

gerade  
straight  
recta  
droite  
diritta



Wilkes Retractor  
38-751-01-07 -  
38-751-03-07

# Osteotome

Osteotomes  
 Osteótomos  
 Ostéotomes  
 Osteotomi

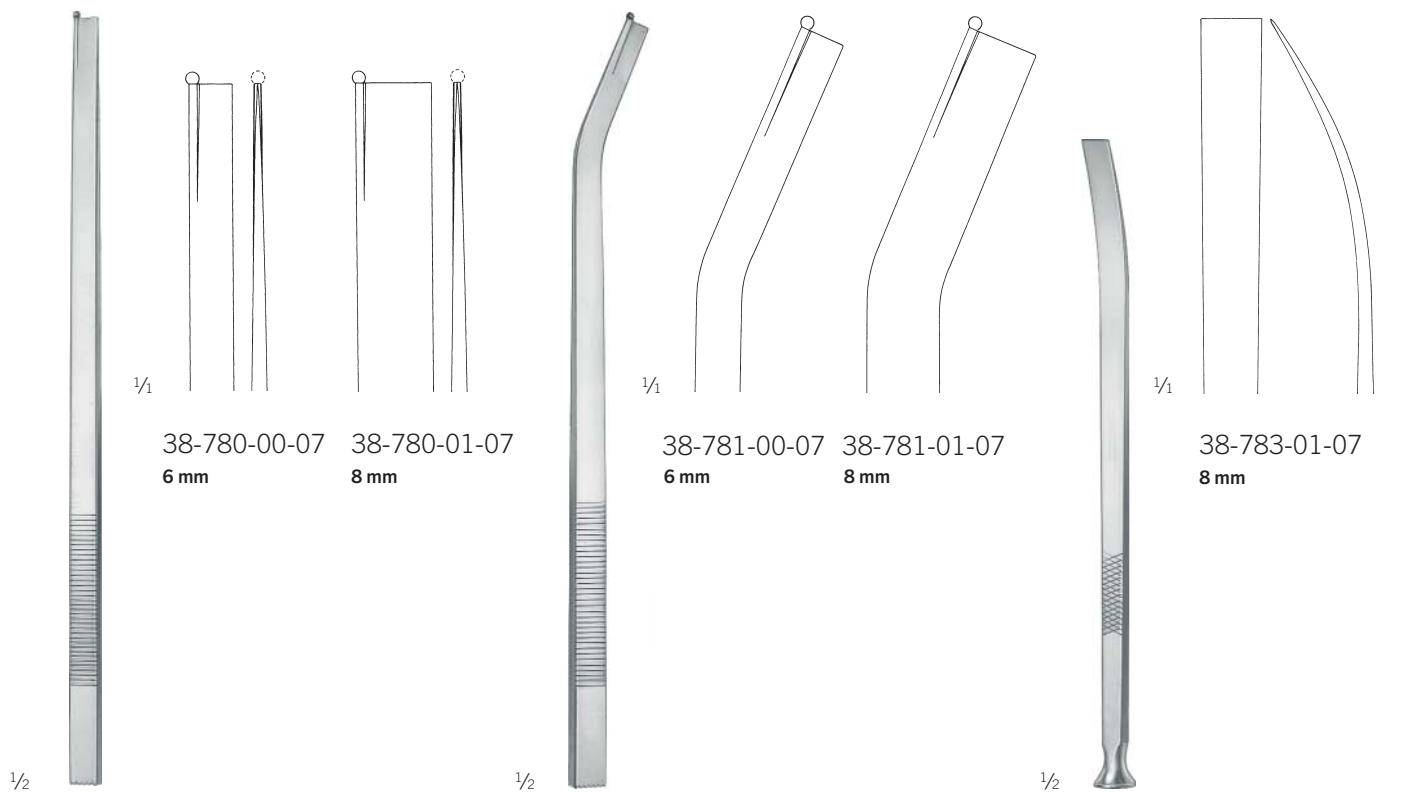

Bauer  
 38-780-00-07 -  
 38-780-01-07  
 20,5 cm / 8 1/8"

Bauer  
 38-781-00-07 -  
 38-781-01-07  
 20,5 cm / 8 1/8"

Epker-Bauer  
 38-783-01-07  
 17,5 cm / 6 7/8"

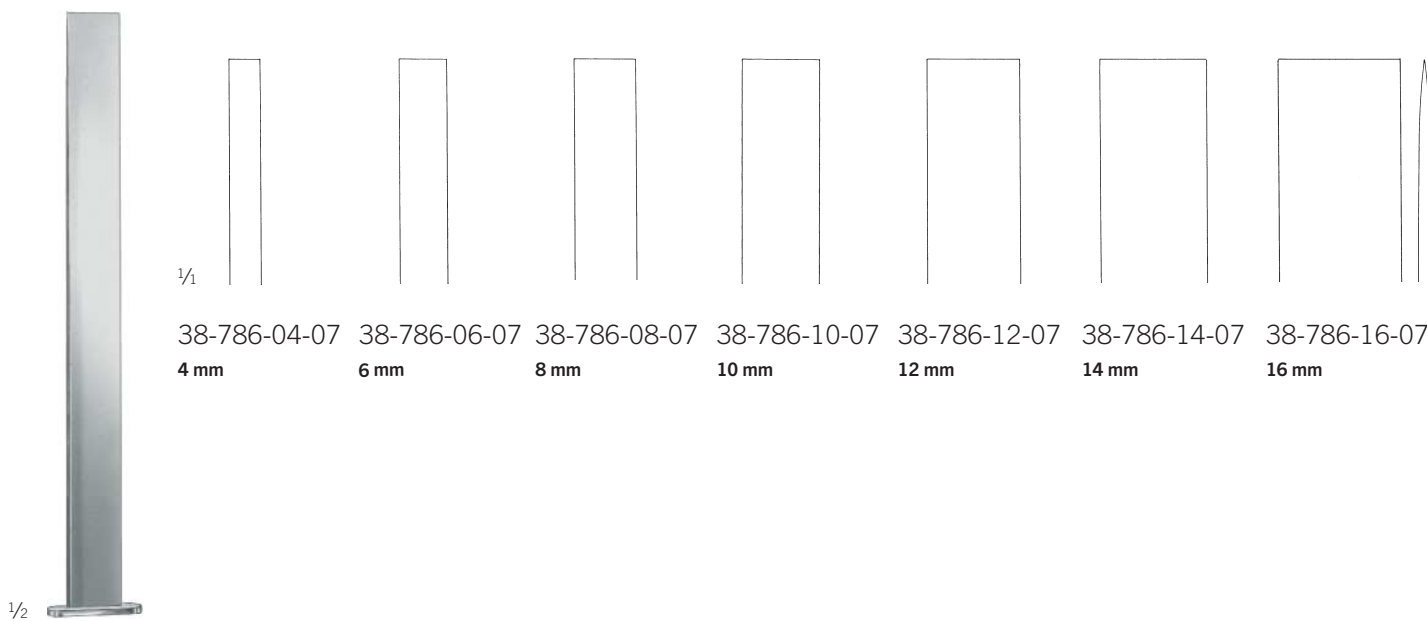

Dautrey-Munro  
 38-786-04-07 -  
 38-786-16-07  
 16 cm / 6 3/8"



# Osteotome

Osteotomes  
Osteótomos  
Ostéotomes  
Osteotomi

# Kraniomaxillofaziale Chirurgie

Craniomaxillofacial surgery  
Cirugía cráneo-maxilofacial  
Chirurgie crânio-maxillofaciale  
Chirurgia cranio-maxillofaciale

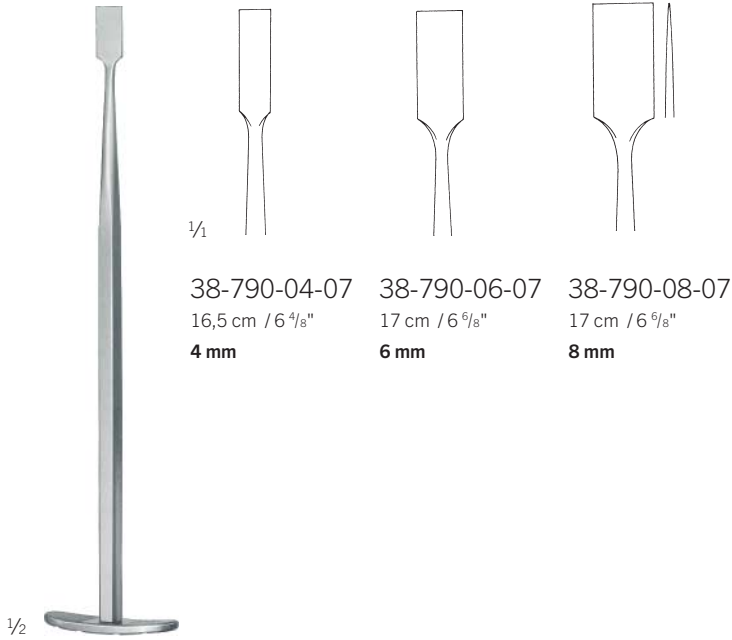

1/4

38-790-04-07  
16,5 cm / 6 4/8"  
4 mm

38-790-06-07  
17 cm / 6 6/8"  
6 mm

38-790-08-07  
17 cm / 6 6/8"  
8 mm

1/2

Dunn-Dautrey  
38-790-04-07 -  
38-790-08-07

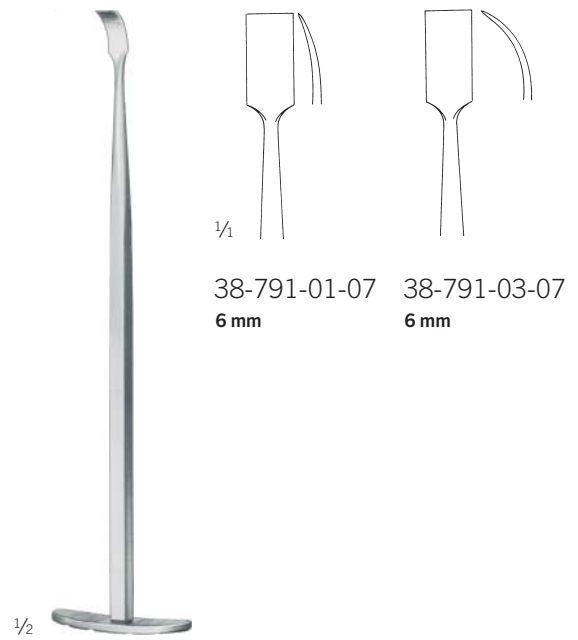

1/4

38-791-01-07  
6 mm

38-791-03-07  
6 mm

1/2

Dunn-Dautrey  
38-791-01-07 -  
38-791-03-07  
17 cm / 6 6/8"



1/4

8 mm

1/2

Dunn-Dautrey  
38-793-03-07  
16,5 cm / 6 4/8"

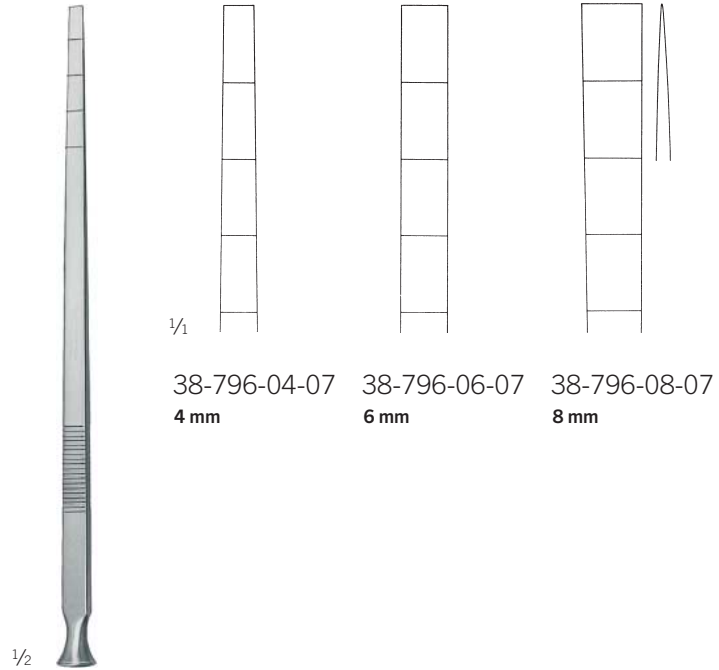

1/4

38-796-04-07  
4 mm

38-796-06-07  
6 mm

38-796-08-07  
8 mm

1/2

Epker  
38-796-04-07 -  
38-796-08-07  
18 cm / 7 1/8"

## Osteotome, Meißel

Osteotomes, Chisels

Osteótomos, Cinceles

Ostéotomes, Ciseaux-burins

Osteotomi, Scalpelli

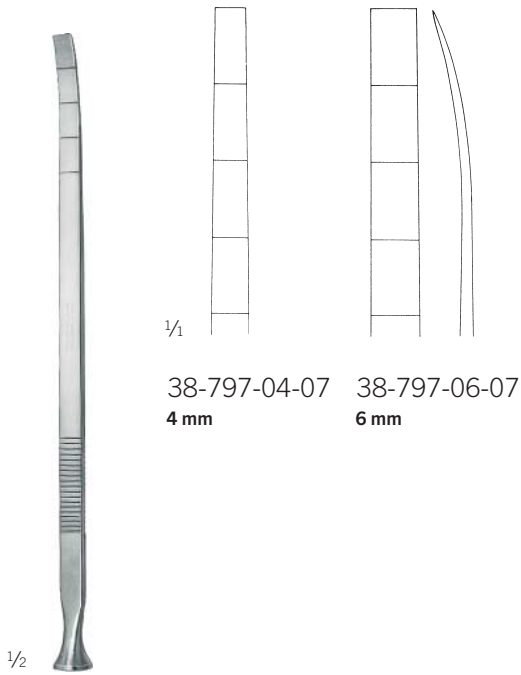

38-797-04-07  
4 mm

38-797-06-07  
6 mm

Epker  
38-797-04-07 -  
38-797-06-07  
18 cm / 7 1/8"

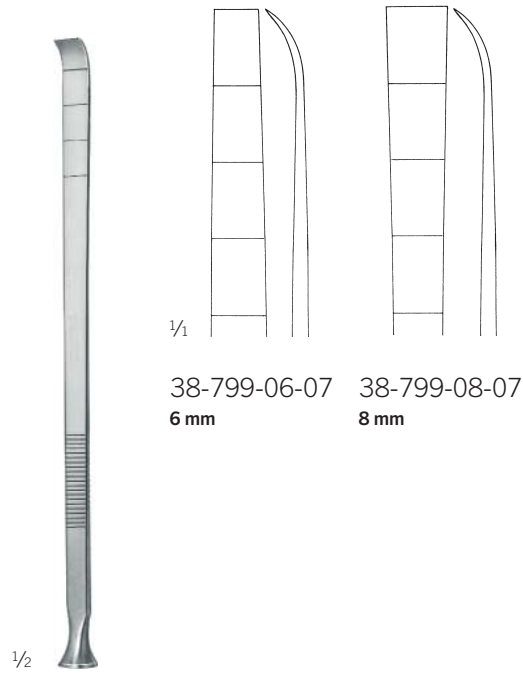

38-799-06-07  
6 mm

38-799-08-07  
8 mm

Epker  
38-799-06-07 -  
38-799-08-07  
18 cm / 7 1/8"



38-810-00-07  
3,7 mm

Urata  
38-810-00-07  
15 cm, 6"  
Spatel  
Spatulas  
Espátulas  
Spatules  
Spatole

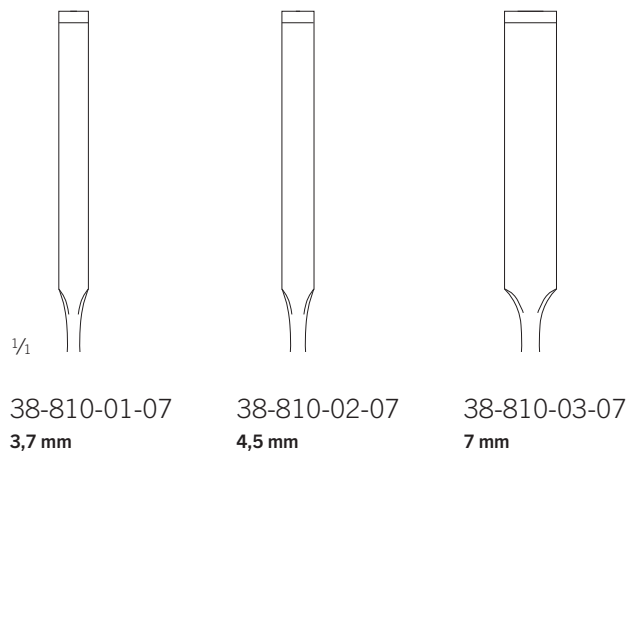

38-810-01-07  
3,7 mm

38-810-02-07  
4,5 mm

38-810-03-07  
7 mm

Martini  
38-810-01-07 -  
38-810-03-07  
15 cm, 6"  
Spatel  
Spatulas  
Espátulas  
Spatules  
Spatole

## Ramushaken

Ramus Retractors  
Separadores para el ramo  
Ecarteurs pour ramus  
Divaricatori per il ramo

## Kraniomaxillofaziale Chirurgie

Craniomaxillofacial surgery  
Cirugía cráneo-maxilofacial  
Chirurgie crânio-maxillofaciale  
Chirurgia cranio-maxillofaciale



1/2

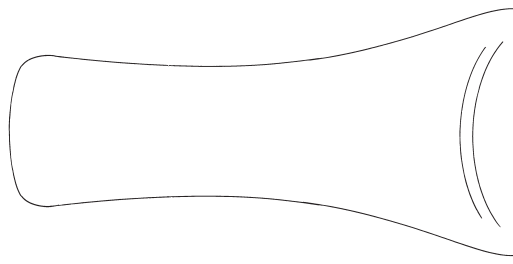
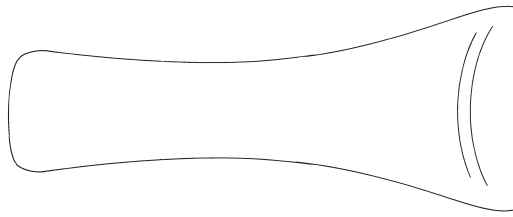

1/1

Hargis  
38-829-00-07

16 cm / 6 2/8"

Lippen- und Wangenhalter  
Lip and Cheek Retractor  
Separador para labios y mejillas  
Ecarteur pour lèvres et joues  
Separatore per labbra e guancia



1/2

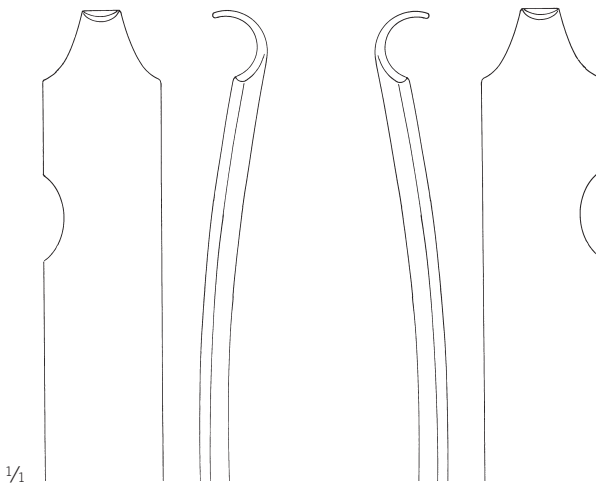

1/1

38-831-01-07

links  
left  
izquierdo  
gauche  
sinistra

38-831-02-07

rechts  
right  
derecho  
droit  
destra

Hargis  
38-831-01-07 -  
38-831-02-07

19,5 cm / 7 5/8"

## Unterkieferkörperhaken, Vorderrandstripper

Mandibular Body Retractor, Anterior Border Stripper

Separador para el cuerpo mandibular, Separador para el borde anterior

Ecarteur pour corps mandibulaire, Ecarteur pour le bord antérieur

Separatore per il corpo mandibulare, Separatore per il bordo anteriore



Hargis  
38-833-18-07  
17,5 cm / 6 7/8"

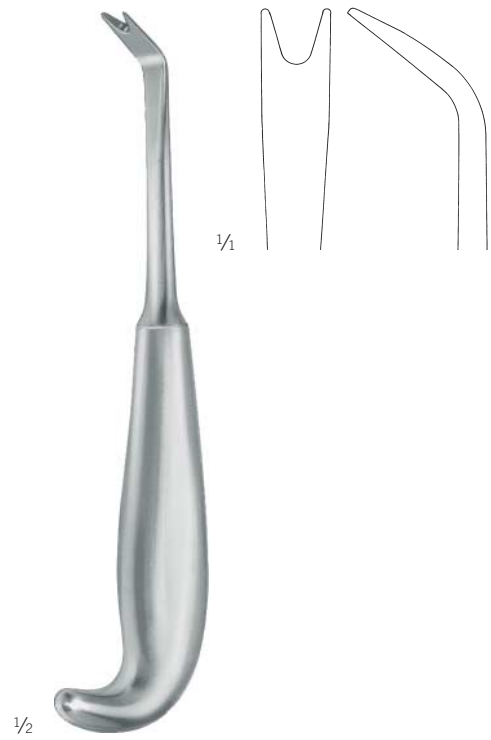

Hargis  
38-835-19-07  
18,5 cm / 7 2/8"

## Raspatorien

Periosteal Elevators  
Legras  
Rugine-raspatoires  
Elevatori per periosteo

## Kraniomaxillofaziale Chirurgie

Craniomaxillofacial surgery  
Cirugía cráneo-maxilofacial  
Chirurgie crânio-maxillofaciale  
Chirurgia cranio-maxillofaciale

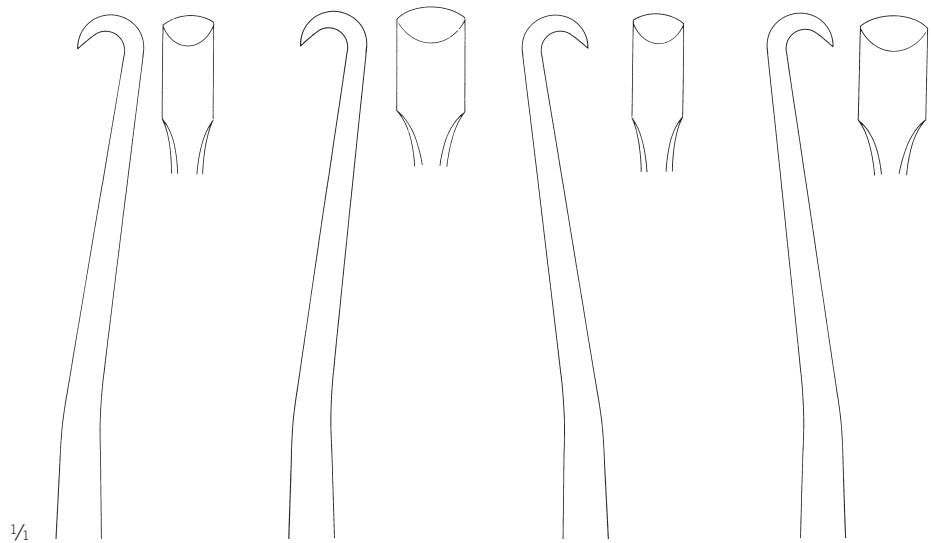

38-837-01-07

23,5 cm / 9 2/8"

**6,5 mm**

rechts  
right  
derecho  
droit  
destra

38-837-02-07

23 cm / 9"

**9 mm**

rechts  
right  
derecho  
droit  
destra

38-837-03-07

23,5 cm / 9 2/8"

**6,5 mm**

links  
left  
izquierdo  
gauche  
sinistra

38-837-04-07

23 cm / 9"

**9 mm**

links  
left  
izquierdo  
gauche  
sinistra

1/2

Hargis  
38-837-01-07 -  
38-837-04-07

## Piriformis-Haken, Pterygoideus-Osteotom, Knochenfassklemme

Periform Rim Retractor, Pterygoid Osteotome, Bone Holding Forceps

Gancho piriforme, Osteótomo pterigoideo, Pinza para coger huesos

Crochet pour la fosse piriforme, Ostéotome ptérygoïde, Pince pour saisir os

Divaricatore per piriforme, Osteotomo per pterigoideo, Afferratoio per ossa

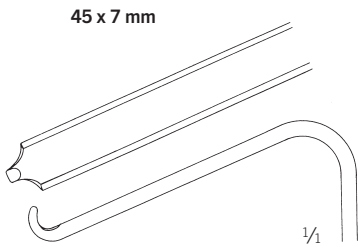

1/2

Hargis  
38-839-18-07  
18,5 cm / 7 2/8"

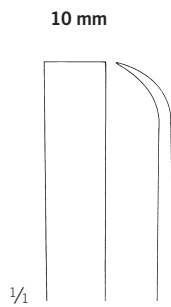

1/2

Hargis  
38-841-22-07  
22 cm / 8 5/8"



1/2

Hargis  
38-843-19-07  
19 cm / 7 4/8"  
mit Kette  
with chain  
con catena  
avec chaîne  
con catena



1:2



1/2

38-843-99-07  
55 cm / 21 5/8"  
Kette, allein  
Chain, only  
Catena, suelto  
Chaîne, seul  
Catena, solo



38-843-19-07

## Sagittalspreizer, Spreizzange

Sagittal Split Separators, Ramus Separator  
Separadores sagitales, Pinza para separar la rama  
Ecarteurs sagitaux, Pince pour séparer ramus  
Separatori sagittali, Pinza per separare il ramo

## Kraniomaxillofaziale Chirurgie

Craniomaxillofacial surgery  
Cirugía cráneo-maxilofacial  
Chirurgie crânio-maxillofaciale  
Chirurgia cranio-maxillofaciale

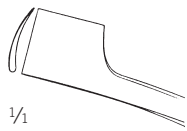

1/1

9 mm

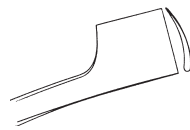

9 mm



1/2



1/2

Smith  
38-845-01-07

18,5 cm / 7 2/8"

rechts  
right  
derecho  
droit  
destra

Smith  
38-845-02-07

18,5 cm / 7 2/8"

links  
left  
izquierdo  
gauche  
sinistra



1/2

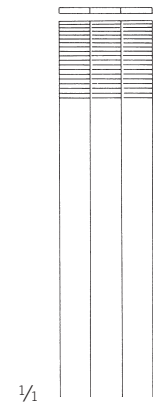

1/1

Smith  
38-846-20-07

23,5 cm / 9 2/8"

## Mylohyoideusklemmen

Mylohyoid Muscle Clamps

Pinzas para el músculo milohioideo

Clamp mylohyoidal

Pinze per muscolo miloideo

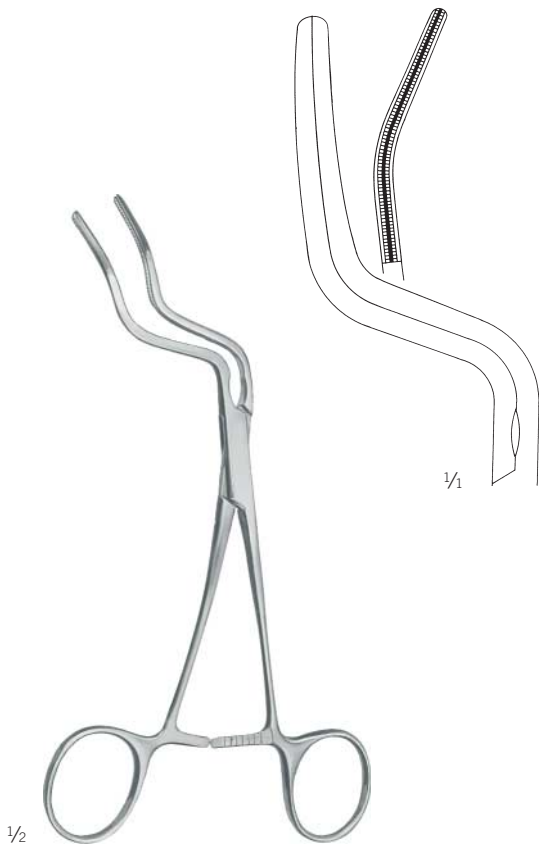

Terry  
38-850-01-07  
17 cm / 6 5/8"  
links  
left  
izquierdo  
gauche  
sinistra

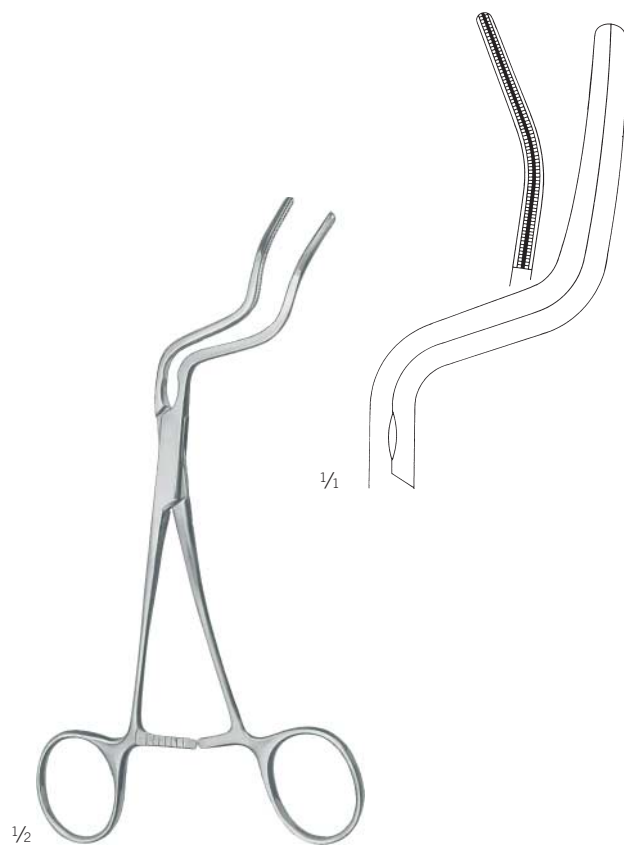

Terry  
38-850-02-07  
17 cm / 6 5/8"  
rechts  
right  
derecho  
droit  
destra



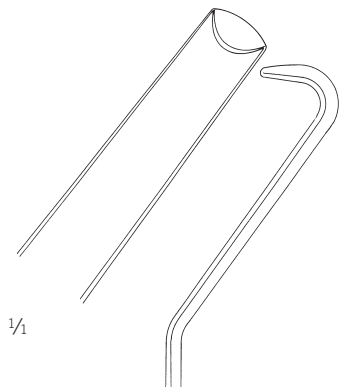

**Terry**  
 38-851-16-07

16,5 cm / 6 1/8"

Unterkieferhaken  
 Mandibular Retractors  
 Gancho mandibular  
 Crochet mandibulaire  
 Divaricatore per mandibula

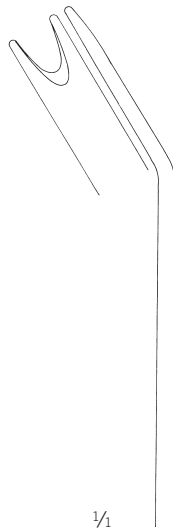

**Terry**  
 38-853-24-07

24 cm / 9 1/8"

Ramusschieber  
 Ramus Pusher  
 Corredera de rama  
 Manipulateur pour ramus  
 DPosizionatore per ramo

Ø 2,5 mm

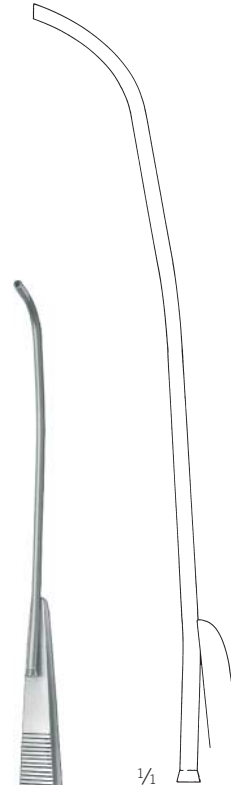

**Terry**  
 38-855-17-07

17 cm / 6 5/8"

Drahteinführinstrument  
 Wire Introducer,  
 Introducitor de alambre  
 Introducteur pour fil  
 Introduttore per filo

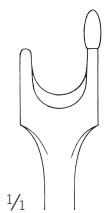

**Terry**  
 38-856-19-07

19 cm / 7 4/8"

Septumosteotom  
 Septal Osteotome  
 Osteótomo nasal  
 Ostéotome nasale  
 Osteotomo nasale

## Haken, Elevatorien

Hooks, Elevators

Ganchos, Elevadores

Ecarteurs, Élévateurs

Divaricatori, Elevatori

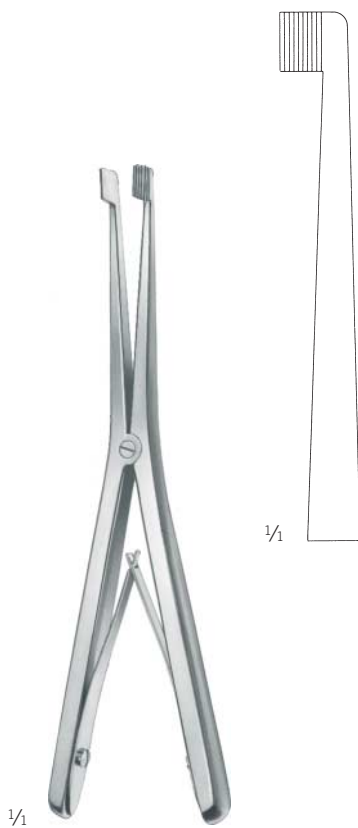

Turvey  
38-870-17-07  
17 cm / 6 5/8"

Unterkieferhaken  
Mandibular Retractors  
Gancho mandibular  
Crochet mandibulaire  
Divaricatore per mandibula

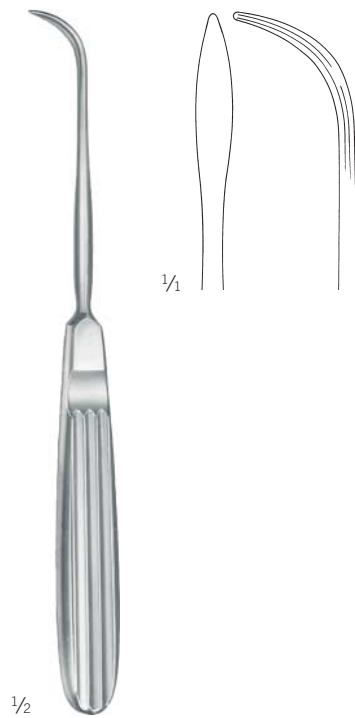

Steinhäuser  
38-875-18-07  
18,5 cm / 7 2/8"

Unterkieferhaken  
Mandibular Retractors  
Gancho mandibular  
Crochet mandibulaire  
Divaricatore per mandibula



Steinhäuser  
38-877-00-07  
27 cm / 10 5/8"

Elevatorium, extra lang  
Elevator, extra long  
Elevador de rama, muy largo  
Élévateur, très long  
Elevatore, molto lungo

## Ramusklappen

Ramus Clamps  
Pinzas de rama  
Clamps pour ramus  
Pinze per ramo

## Kraniomaxillofaziale Chirurgie

Craniomaxillofacial surgery  
Cirugía cráneo-maxilofacial  
Chirurgie crânio-maxillofaciale  
Chirurgia cranio-maxillofaciale

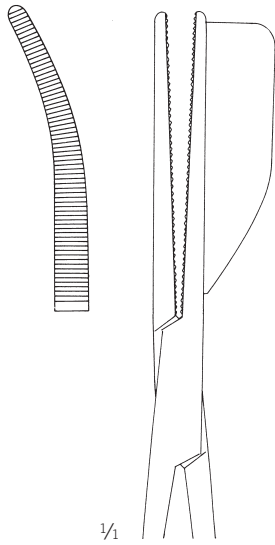

1/1

38-878-01-07

rechts  
right  
derecho  
droit  
destra

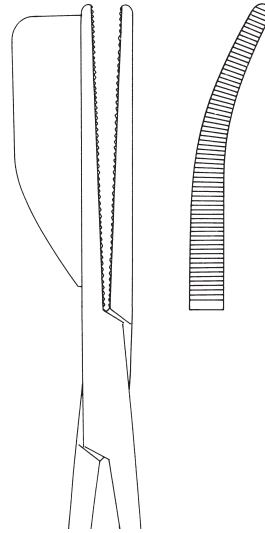

38-878-02-07

links  
left  
izquierdo  
gauche  
sinistra



1/2

Steinhäuser  
38-878-01-07  
16 cm / 6 2/8"



1/2

Steinhäuser  
38-878-02-07  
16 cm / 6 2/8"

## Ramusosteotome, Meißel

Ramus Osteotomes, Chisels

Osteótomos de rama, Cinceles

Ostéotome pour ramus, Ciseaux-burins

Osteotomi per ramo, Scalpelli

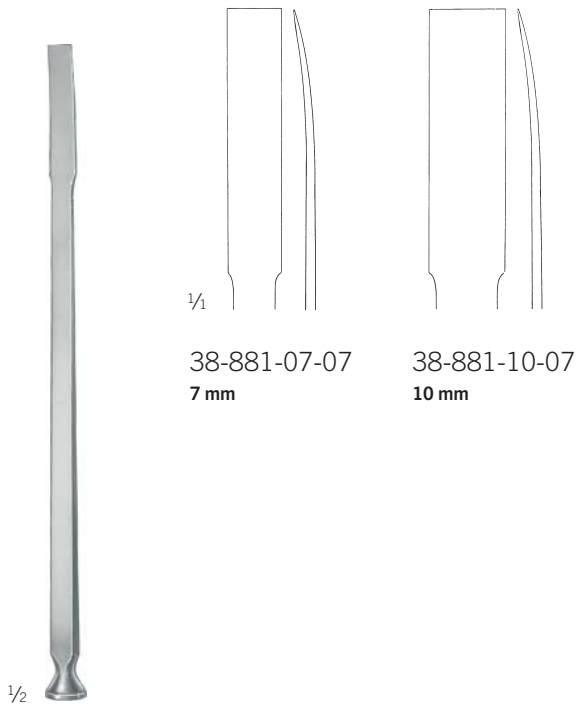

### Steinhäuser

38-881-07-07 - 38-881-10-07

17 cm / 6 5/8"

flexibel  
flexible  
flexible  
flexible  
flessibile

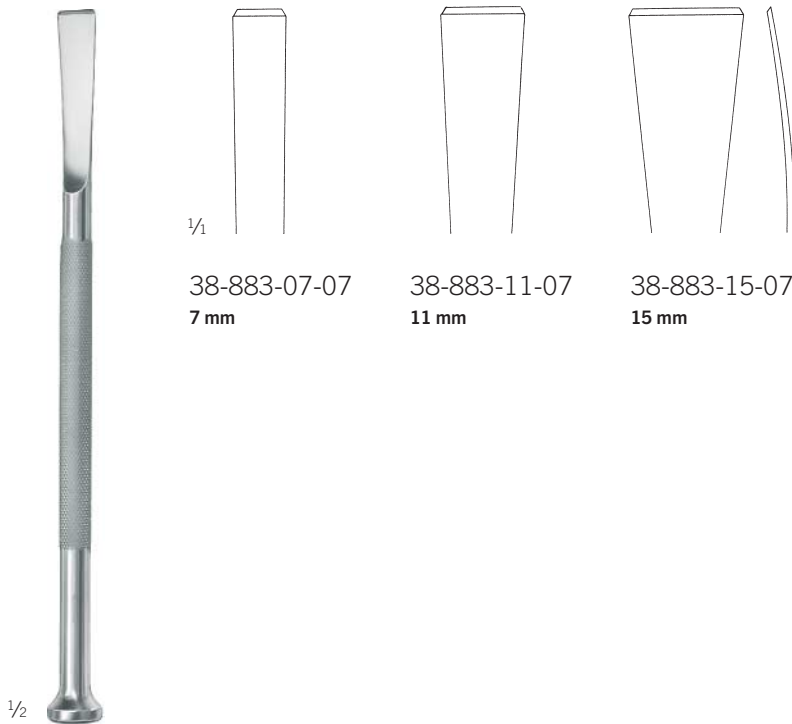

Steinhäuser  
38-883-07-07 -  
38-883-15-07

19 cm / 7 1/8"

Steinhäuser  
38-885-18-07

18 cm / 7 1/8"

Repositionsinstrument  
Reposition Instrument  
Instrumento de reposición  
Pince de réposition  
Strumento per riduzione

## Zygoma-Wundhaken

Zygomatic Retractor  
Separador cigomático  
Ecarteur cygomatique  
Divaricatore per zigomo

## Kraniomaxillofaziale Chirurgie

Craniomaxillofacial surgery  
Cirugía cráneo-maxilofacial  
Chirurgie crânio-maxillofaciale  
Chirurgia cranio-maxillofaciale



1/2

Steinhäuser  
38-891-01-07 -  
38-891-02-07  
25 cm / 9 7/8"

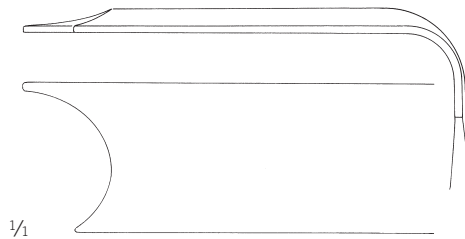

1/1

38-891-01-07

rechts  
right  
derecho  
droit  
destra  
**50 x 20 mm**

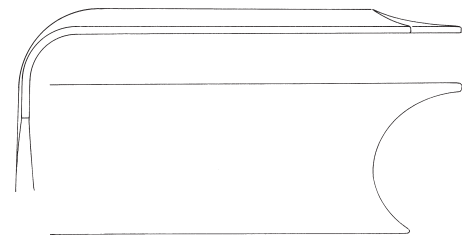

38-891-02-07

links  
left  
izquierdo  
gauche  
sinistra  
**50 x 20 mm**

## Raspatorien, Osteotome

Raspatories, Osteotomes

Legras, Osteótomos

Rugine-raspatoires, Ostéotomes

Elevatori per periosteo, Osteotomi

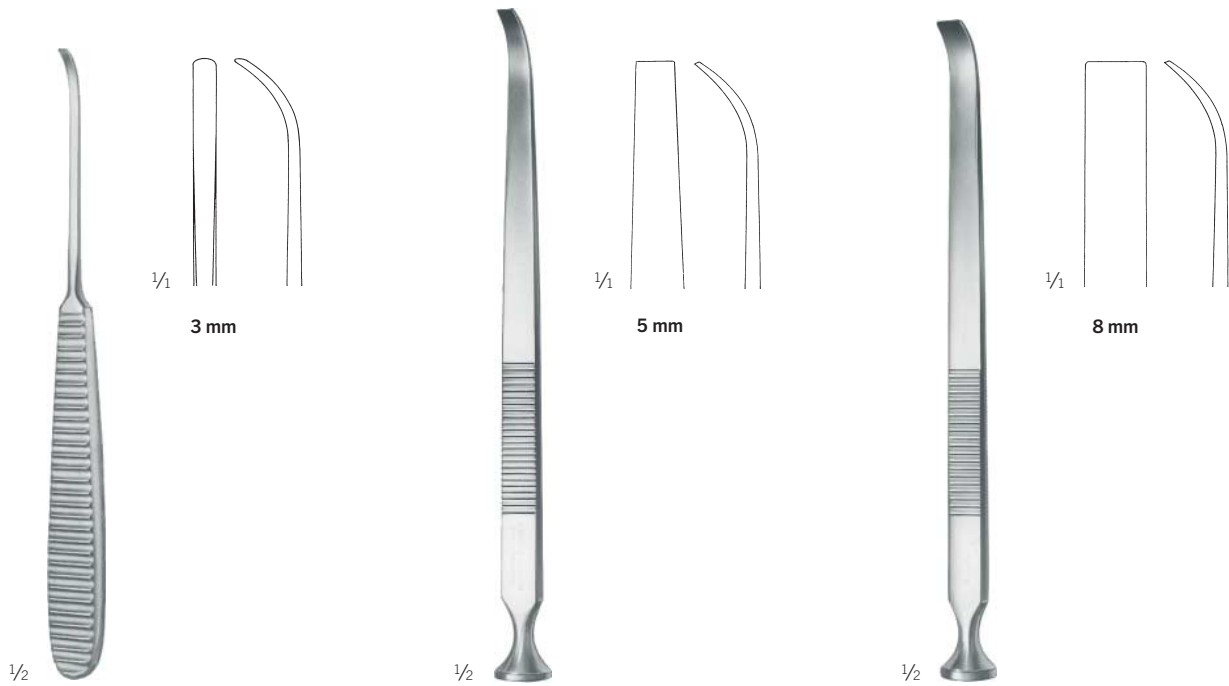

Steinhäuser  
38-893-16-07  
16,5 cm / 6 <sup>5</sup>/<sub>8</sub>"

Steinhäuser  
38-895-05-07  
18 cm / 7 <sup>1</sup>/<sub>8</sub>"

Steinhäuser  
38-895-08-07  
18 cm / 7 <sup>1</sup>/<sub>8</sub>"



38-899-06-07  
6 mm

38-899-08-07  
8 mm

Wolford  
38-899-06-07 -  
38-899-08-07  
21,5 cm / 8 <sup>4</sup>/<sub>8</sub>"

## Weichteilhaken

Soft Tissue Retractors  
Separadores para partes blandas  
Ecarteurs pour parties molles  
Divaricatori per tessuti molli

## Kraniomaxillofaziale Chirurgie

Craniomaxillofacial surgery  
Cirugía cráneo-maxilofacial  
Chirurgie crânio-maxillofaciale  
Chirurgia cranio-maxillofaciale

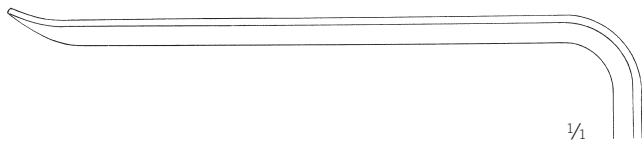

1/2

Obwegeser  
48-101-16-07 -  
48-101-80-07  
aufwärts gebogen  
bent upwards  
angulado hacia arriba  
coudé en haut  
angolato in alto

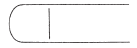

48-101-16-07

21,5 cm / 8 <sup>4</sup>/<sub>8</sub>"

16 x 5 mm

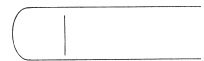

48-101-25-07

21 cm / 8 <sup>2</sup>/<sub>8</sub>"

25 x 7 mm

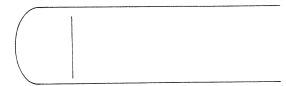

48-101-35-07

23 cm / 8"

35 x 10 mm

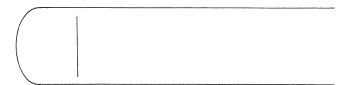

48-101-42-07

23 cm / 8"

42 x 10 mm

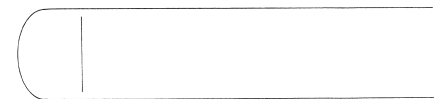

48-101-55-07

23,5 cm / 9 <sup>2</sup>/<sub>8</sub>"

57 x 12,5 mm

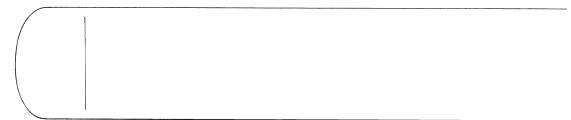

48-101-70-07

23,8 cm / 9 <sup>3</sup>/<sub>8</sub>"

72 x 15 mm

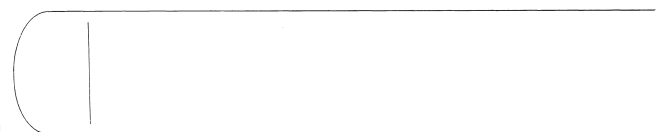

1/1

48-101-80-07

24 cm / 9 <sup>4</sup>/<sub>8</sub>"

86 x 17 mm

## Weichteilhaken

Soft Tissue Retractors

Separadores para partes blandas

Ecarteurs pour parties molles

Divaricatori per tessuti molli

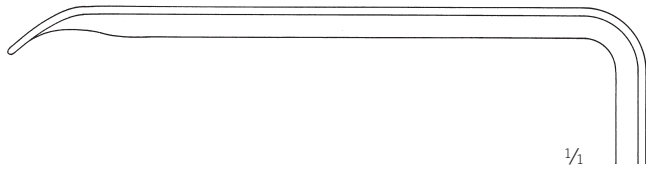

Obwegeser  
48-103-16-07 -  
48-103-80-07

abwärts gebogen  
bent downwards  
angulado hacia abajo  
coudé en bas  
angolato in basso

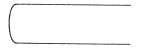

48-103-16-07

21 cm / 8 2/8"

16 x 5 mm

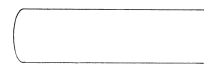

48-103-25-07

21 cm / 8 2/8"

25 x 7 mm

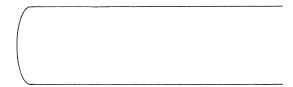

48-103-35-07

23 cm / 8"

35 x 10 mm

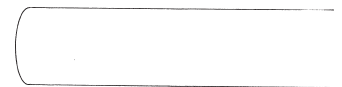

48-103-42-07

23 cm / 8"

42 x 10 mm

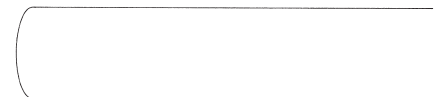

48-103-55-07

23,5 cm / 9 2/8"

55 x 12 mm

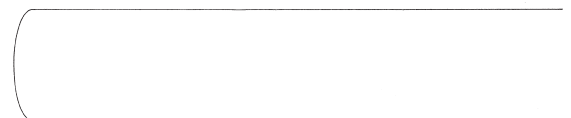

48-103-70-07

23,5 cm / 9 2/8"

72 x 15 mm

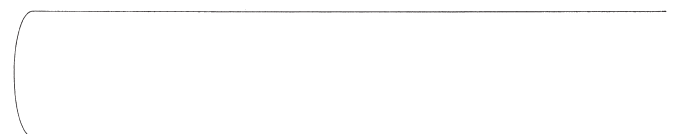

48-103-80-07

23,5 cm / 9 2/8"

86 x 17 mm



## Haken

Retractors  
Separadores  
Ecarteurs  
Divaricatori

## Kraniomaxillofaziale Chirurgie

Craniomaxillofacial surgery  
Cirugía cráneo-maxilofacial  
Chirurgie crânio-maxillofaciale  
Chirurgia cranio-maxillofaciale

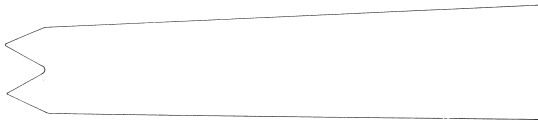

48-107-22-07  
75 x 11/15 mm

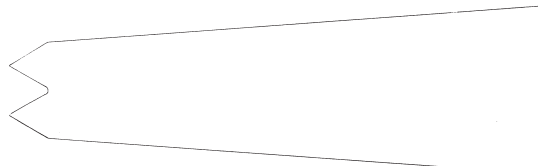

1/1

48-109-22-07  
75 x 12/22 mm



1/1

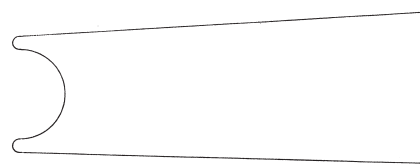
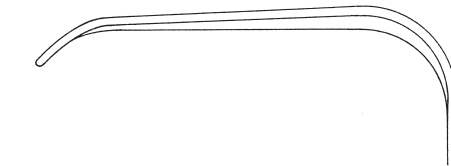

1/1

75 x 12/22 mm

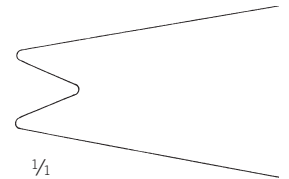

1/1

45 x 10/23 mm



1/2

Obwegeser  
48-107-22-07 - 48-109-22-07

24 cm / 9 4/8"

Ramushaken  
Ramus Retractors  
Separadores para el ramo  
Ecarteurs pour ramus  
Divaricatori per il ramo



1/2

Obwegeser  
48-111-22-07

24 cm / 9 4/8"

Weisheitszahn-Haken  
Third Molar Retractor  
Separador para muela del juicio  
Ecarteur pour dent de sagesse  
Separatore per il dente del giudizio



1/2

Obwegeser  
48-113-22-07

24 cm / 9 4/8"

Spina nasalis-Haken  
Nasal Spine Retractor  
Separador para espina nasal  
Ecarteur pour spina nasalis  
Separatore per spina nasale

## Ramusklappen, Progenierinnen

Ramus Clamps, Channel Retractors

Pinzas para el ramo, Separadores mandibulares

Pinces pour ramus, Ecarteurs mandibulaires

Pinze per il ramo, Divaricatori mandibulari



1/2

Obwegeser  
48-115-01-07

16,5 cm / 6 1/8"

kleines Modell, rechts  
small pattern, right  
modelo pequeño, derecho  
modèle petit, droite  
modello piccolo, destro



1/2

Obwegeser  
48-115-02-07

16,5 cm / 6 1/8"

kleines Modell, links  
small pattern, left  
modelo pequeño, izquierdo  
modèle petit, gauche  
modello piccolo, sinistra

Obwegeser  
48-117-01-07

17 cm / 6 5/8"

großes Modell, rechts  
large pattern, right  
modelo grande, derecho  
modèle grand, droite  
modello grande, destro

Obwegeser  
48-117-02-07

17 cm / 6 5/8"

großes Modell, links  
large pattern, left  
modelo grande, izquierdo  
modèle grand, gauche  
modello grande, sinistra



1/2

Obwegeser  
48-121-08-07 -  
48-121-10-07

1/1

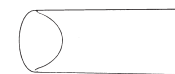

48-121-08-07

16 cm / 6 2/8"

**9 mm**

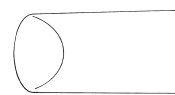

48-121-10-07

16,5 cm / 6 1/8"

**10 mm**



1/2

Obwegeser  
48-125-15-07

16 cm / 6 2/8"

Kinnhalter  
Chin Holder  
Separador para mentón  
Ecarteurs pour menton  
Separatore per mento

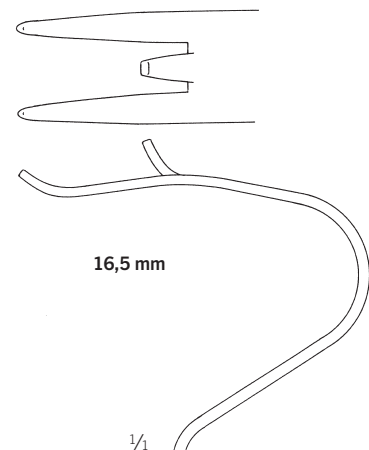

**16,5 mm**

1/1

## Raspatorien

Periosteal Elevators  
Periostótomos  
Rugines-raspatoires  
Periostotomi

## Kraniomaxillofaziale Chirurgie

Craniomaxillofacial surgery  
Cirugía cráneo-maxilofacial  
Chirurgie crânio-maxillofaciale  
Chirurgia cranio-maxillofaciale

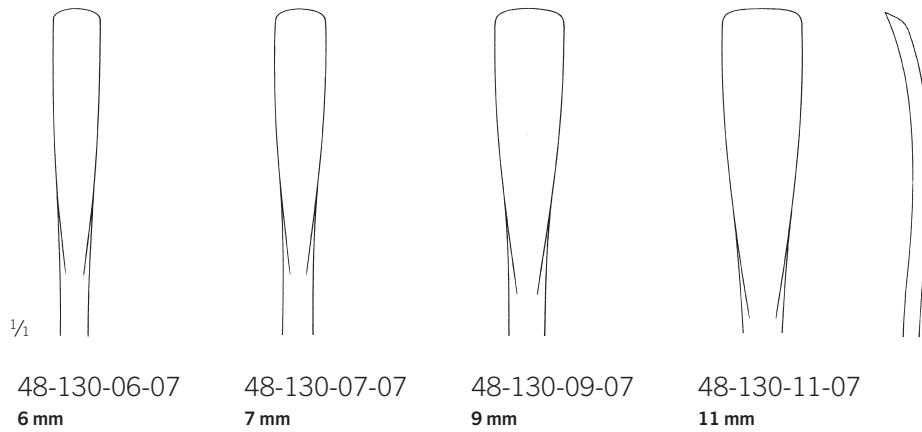

Obwegeser  
48-130-06-07 - 48-130-11-07

18 cm / 7 1/8"

winkelig angeschliffen  
angled cutting  
biselado angular  
tranchant angulé  
affilatura angolata

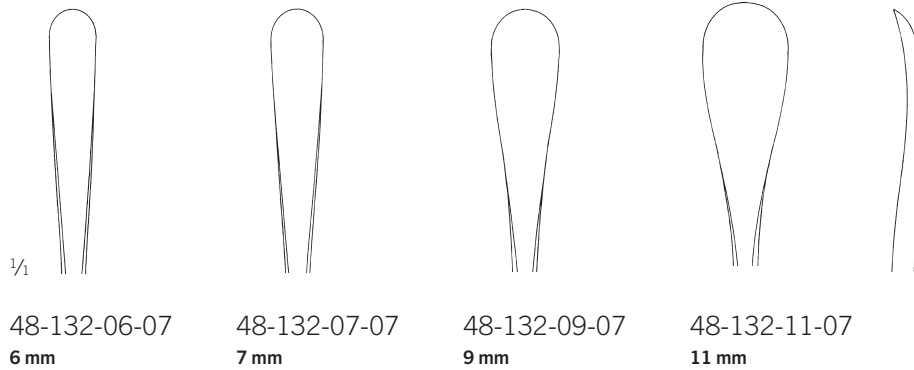

Obwegeser  
48-132-06-07 - 48-132-11-07

18 cm / 7 1/8"

flach angeschliffen  
flat cutting  
biselado plano  
tranchant plat  
affilatura plana

## Unterkieferrand-Raspatorien, Schwabenschwanz-Raspatorien

Mandibular Inferior Border Raspatories, Swallowtail Raspatories

Legras para el borde mandibular, Legras en forma de cola de milano

Rugine-raspatoires pour le bord mandibulaire, Rugine-raspatoires sous forme de queue d'aronde

Staccaperiostio per bordo mandibulare, Staccaperiostio a coda di rondine



Obwegeser  
48-135-21-07  
21 cm / 8 <sup>2</sup>/<sub>8</sub>"



Obwegeser  
48-137-21-07  
21 cm / 8 <sup>2</sup>/<sub>8</sub>"



Obwegeser  
48-140-01-07  
18 cm / 7 <sup>1</sup>/<sub>8</sub>"  
nach links gewinkelt  
angled to left  
angulado hacia la izquierda  
coudé à gauche  
angolato a sinistra

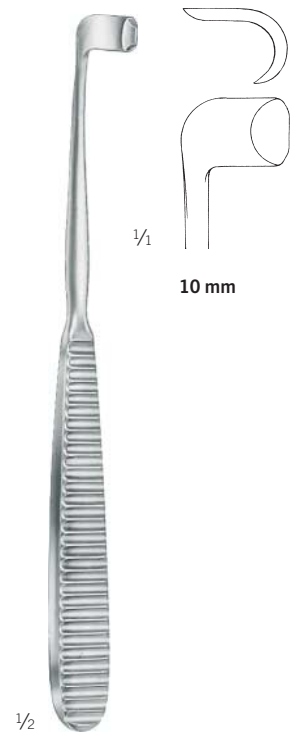

Obwegeser  
48-140-02-07  
18 cm / 7 <sup>1</sup>/<sub>8</sub>"  
nach rechts gewinkelt  
angled to right  
angulado hacia la derecha  
coudé à droite  
angolato a destra

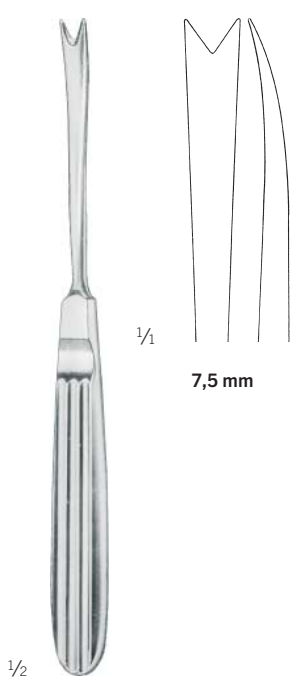

Obwegeser  
48-150-01-07  
17,5 cm / 6 <sup>7</sup>/<sub>8</sub>"

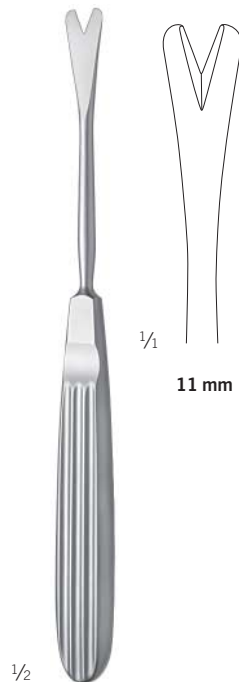

Obwegeser  
48-150-02-07  
17,5 cm / 6 <sup>7</sup>/<sub>8</sub>"

## Ramusraspatorien, Septumosteotome

Ramus Periosteal Elevators, Septonasal Osteotomes

Legras para el ramo, Osteótomos para el tabique nasal

Rugine-raspatoires pour ramus, Ostéotomes pour cloison nasale

Elevatori periostali per ramo, Osteotomo per setto nasale

## Kraniomaxillofaziale Chirurgie

Craniomaxillofacial surgery

Cirugía cráneo-maxilofacial

Chirurgie crânio-maxillofaciale

Chirurgia cranio-maxillofaciale



1/2

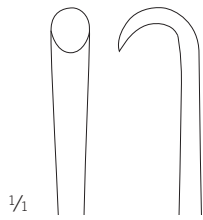

1/4

48-152-05-07  
5 mm

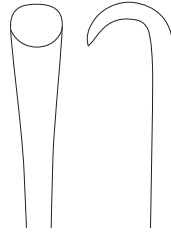

48-152-07-07  
7 mm

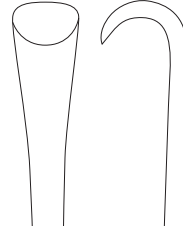

48-152-09-07  
9 mm

Obwegeser

48-152-05-07 - 48-152-09-07

21 cm / 8 1/8"



1/2

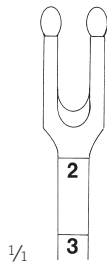

1/4

48-156-04-07  
4 mm

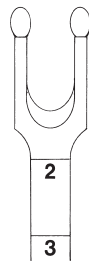

48-156-06-07  
6 mm

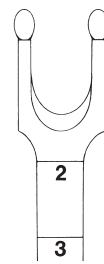

48-156-08-07  
8 mm

Obwegeser

48-156-04-07 - 48-156-08-07

19 cm / 7 1/8"

graduiert  
graduated  
graduado  
gradué  
graduato

## Keilosteotome, Blattosteotome

Wedge Osteotomes, Blade Osteotomes

Osteótomos de cuña, Osteótomos de hoja

Ostéotome cunéiforme, Ostéotome en lame

Osteotomo a forma di cuneo, Osteotomo

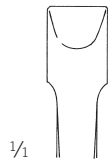

48-160-08-04  
8 mm



48-160-12-04  
12 mm

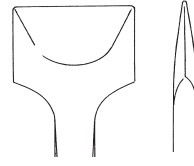

48-160-16-04  
16 mm

Obwegeser  
48-160-08-04 -  
48-160-16-04  
22,5 cm / 8 7/8"

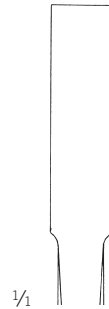

48-162-08-04  
8 mm



48-162-12-04  
12 mm

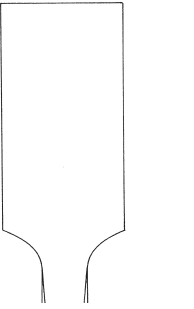

48-162-16-04  
16 mm

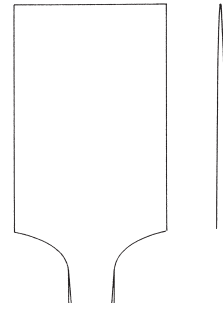

48-162-20-04  
20 mm

Obwegeser  
48-162-08-04 -  
48-162-20-04  
22,5 cm / 8 7/8"



## Fragment-Adaptierungsklemmen

Fragment Adapting Forceps

Pinzas adaptadoras para fragmentos

Clamps pour adaptation de fragments osseux

Pinze per avvicinare frammenti

## Kraniomaxillofaziale Chirurgie

Craniomaxillofacial surgery

Cirugía cráneo-maxilofacial

Chirurgie crânio-maxillofaciale

Chirurgia cranio-maxillofaciale



## Atrauma

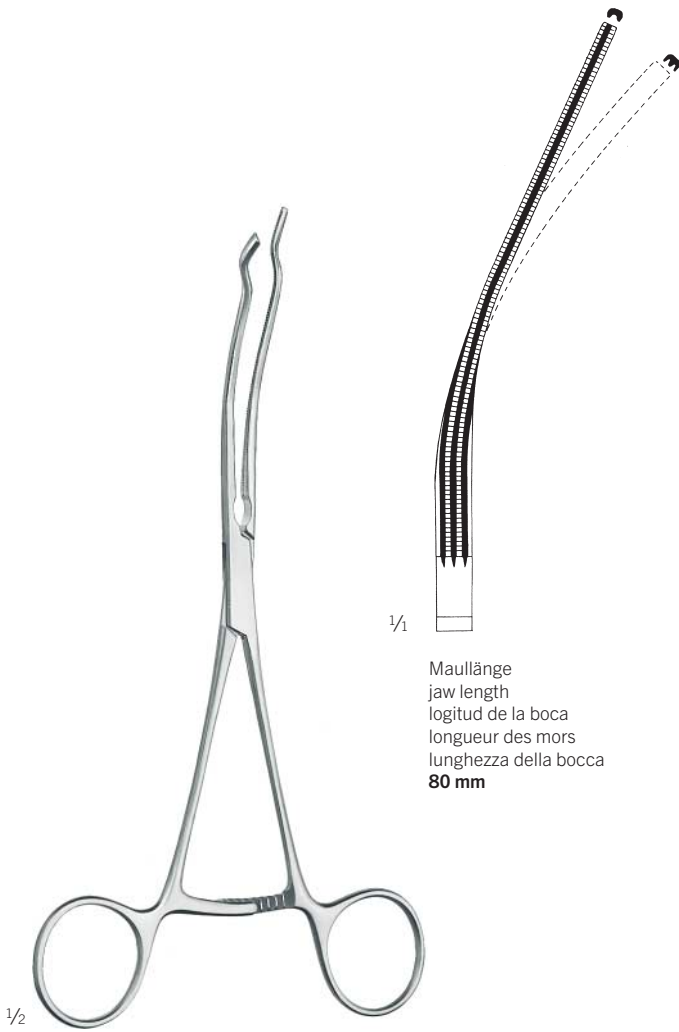

1/2  
1/4  
Maullänge  
jaw length  
logitud de la boca  
longueur des mors  
lunghezza della bocca  
**80 mm**

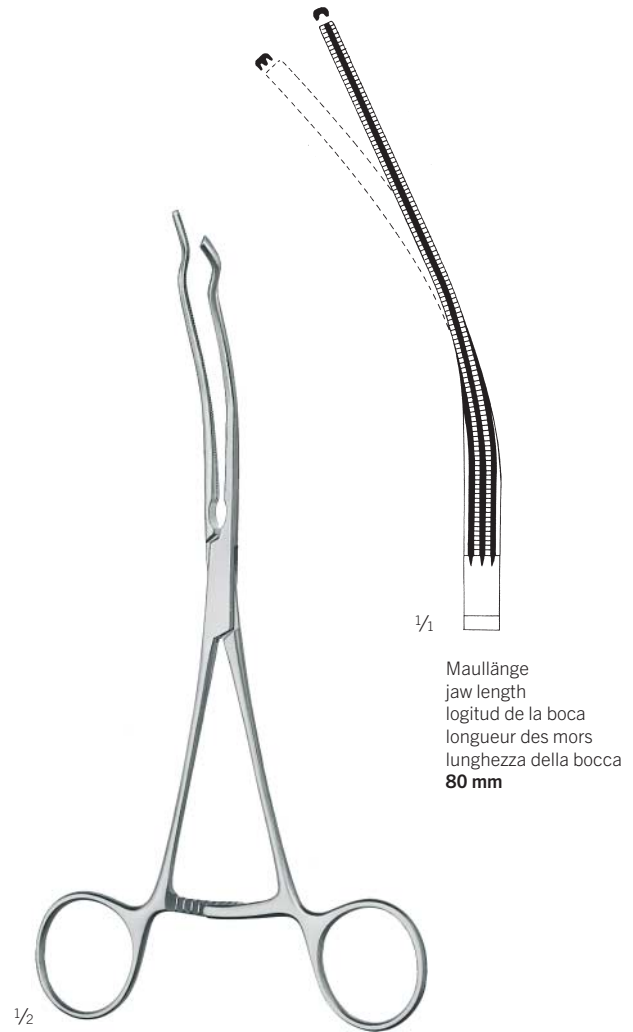

1/2  
1/4  
Maullänge  
jaw length  
logitud de la boca  
longueur des mors  
lunghezza della bocca  
**80 mm**

Obwegeser  
48-163-01-07

21 cm / 8 2/8"

links  
left  
izquierdo  
gauche  
sinistra

Obwegeser  
48-163-02-07

21 cm / 8 2/8"

rechts  
right  
derecho  
droit  
destra

# Knochenspreizer

Bone-spreader

Separador de huesos

Pince à écarter

Pinza per allargare

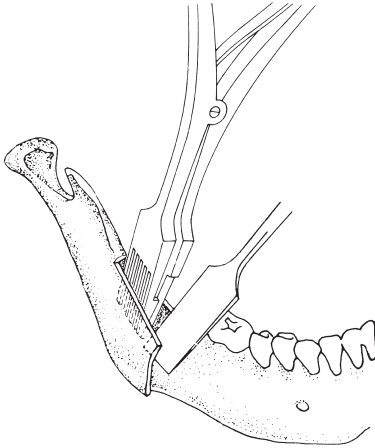

These bone separators serve to open osteotomies, e.g. in sagittal splitting of the lower jaw, in movement of cranial vault segments and in LeFort III osteotomies.



1/2

Obwegeser  
48-164-15-07 -  
48-164-20-07  
22 cm / 8 5/8"

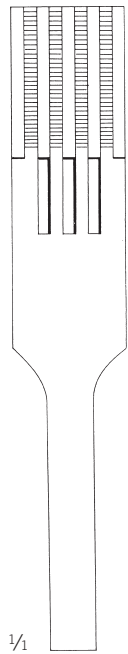

48-164-15-07  
15 mm

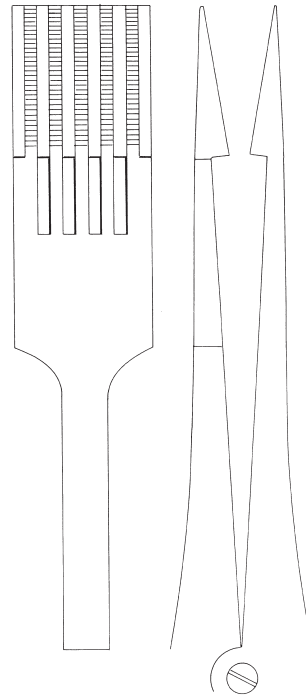

48-164-20-07  
20 mm



## Tuber maxillae-Osteotome, Osteotome, Alveolarfortsatz-Osteotome

Osteotomes for Maxillary Tuber, Osteotomes, Osteotomes for Alveolar Process  
 Osteótomos para tubérculo maxilar, Osteótomos, Osteótomos para el proceso alveolar  
 Ostéotome pour tuber-maxillae, Ostéotomes, Ostéotome pour bord alvéolaire  
 Osteotomo per tuberosità mascellari, Osteotomo, Osteotomo per processo alveolare

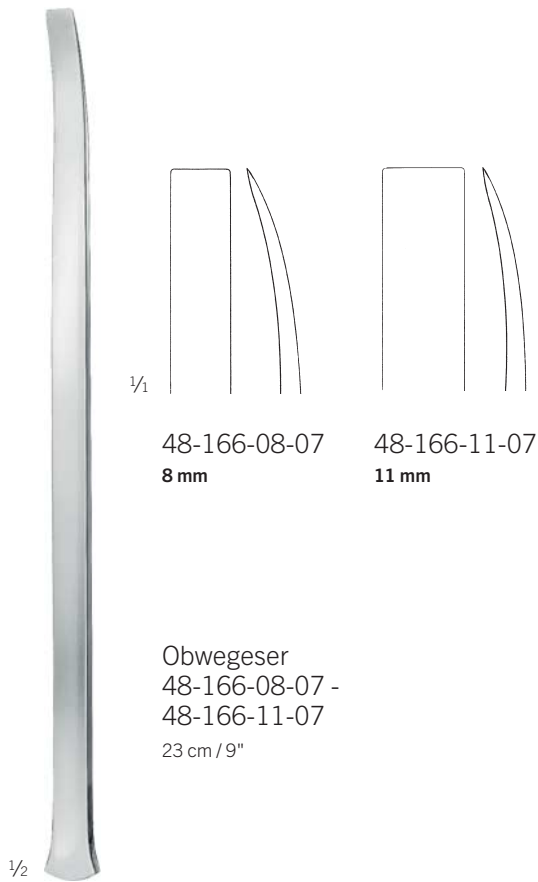
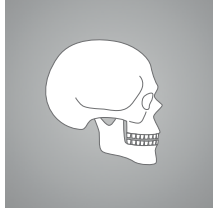

1/2

48-166-08-07  
8 mm

48-166-11-07  
11 mm

Obwegeser  
48-166-08-07 -  
48-166-11-07  
23 cm / 9"

1/2



1/2

48-167-08-07  
8 mm

48-167-11-07  
11 mm

Obwegeser  
48-167-08-07 -  
48-167-11-07  
21 cm / 8 2/8"  
elastische Klinge  
elastic blade  
hoja elástica  
lame élastique  
lama elastica

1/2

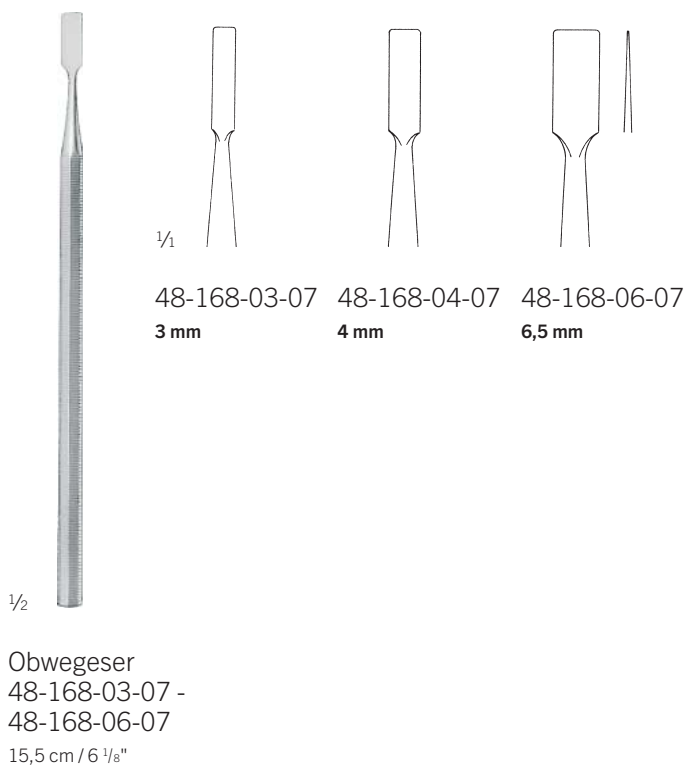

1/2

48-168-03-07  
3 mm

48-168-04-07  
4 mm

48-168-06-07  
6,5 mm

1/2

Obwegeser  
48-168-03-07 -  
48-168-06-07  
15,5 cm / 6 1/8"

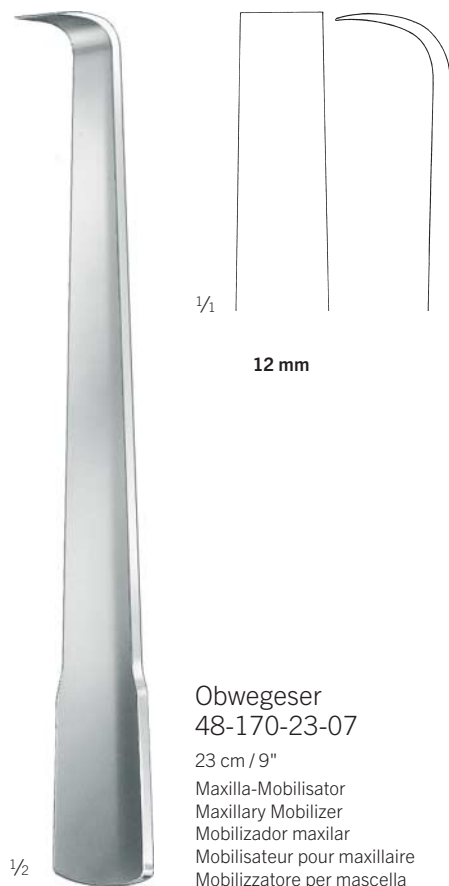

1/2

12 mm

1/2

Obwegeser  
48-170-23-07  
23 cm / 9"  
Maxilla-Mobilisator  
Maxillary Mobilizer  
Mobilizador maxilar  
Mobilisateur pour maxillaire  
Mobilizzatore per mascella

## Unterkieferahlen, Jochbogenahle

Maxillary Awls, Zygomatic Arch Awl

Leznas maxilares, Lezna para el arco cigomático

Alènes maxillaires, Alène pour l'arcade zygomatique

Punteruolo per mandibola, Punteruolo per arco zigomatico



Obwegeser  
48-175-15-07  
15 cm / 5 7/8"



Obwegeser  
48-175-17-07  
17,5 cm / 6 7/8"



Obwegeser  
48-177-24-07  
24 cm / 9 4/8"

## Drahtschneidezange, Flachzangen, Drahtwirbelzangen

Wire Cutter, Flat Nose Pliers, Wire Twisting Forceps

Alicates para alambre, Alicates de pico plano, Pinzas para torcer alambre

Pinces à couper le fil, Pinces plate, Pinces à torsader le fil

Tronchesino, Tenaglie piatta, Pinze per ritorcere fili

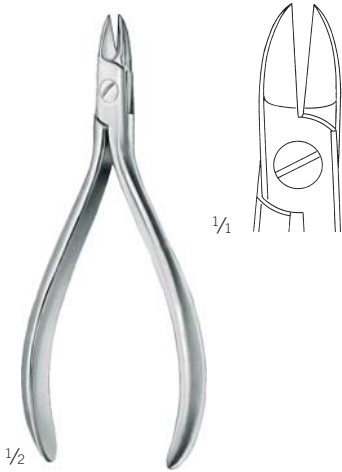

Obwegeser  
48-190-11-07  
12 cm / 4 5/8"



Obwegeser  
48-192-01-07 -  
48-192-03-07

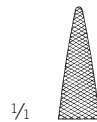

48-192-01-07  
12,5 cm / 4 7/8"



48-192-02-07  
13 cm / 5 1/8"



48-192-03-07  
15 cm / 5 7/8"

## TC GOLD



Obwegeser  
48-194-13-07  
13 cm / 5 1/8"



Obwegeser  
48-196-14-07 -  
48-198-14-07  
14 cm / 5 4/8"



48-196-14-07



48-198-14-07

breites Maul  
wide jaw  
ampia boca  
gueule large  
bocca ampia

## Knochenformzangen

Bone Contouring Forceps

Pinzas para formar huesos

Pinces pour former os

Pinze per afferrare ossa



Maul  
jaw  
boca  
mors  
bocca

**30 x 12 mm**

konvex / konkav  
convex / concave  
convexo / concávo  
convexe / concave  
convesso / concavo

Obwegeser  
48-220-01-07  
18 cm / 7 1/8"

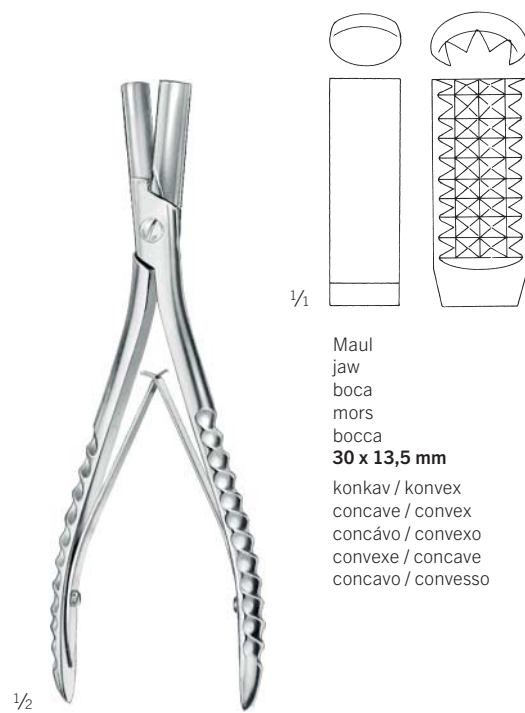

Maul  
jaw  
boca  
mors  
bocca

**30 x 13,5 mm**

konkav / konvex  
concavo / convex  
concávo / convexo  
convexe / concave  
concavo / convesso

Obwegeser  
48-220-02-07  
18 cm / 7 1/8"

## Hauthäkchen, Kopfhautklemme

Skin Hooklet, Scalp Clamp

Ganchito para piel, Pinza para cabelludo

Crochet pour peau, Pince pour le cuir chevelu

Gancio per cute, Pinza per cuoio capelluto

## Kraniomaxillofaziale Chirurgie

Craniomaxillofacial surgery

Cirugía cráneo-maxilofacial

Chirurgie crâno-maxillofaciale

Chirurgia cranio-maxillofaciale



Tessier  
48-250-19-07

19 cm / 7 1/8"

scharf  
sharp  
agudo  
pointu  
acuto

## Atrauma



Tessier  
48-252-13-07

13,5 cm / 5 3/8"

## Nasenspekula

Nasal Specula

Espéculos nasales

Spéculums nasaux

Specoli nasali

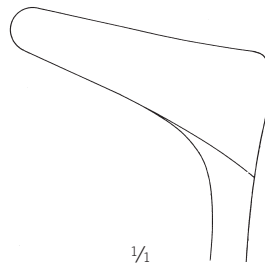

1/1

48-261-30-07

13,5 cm / 5 3/8"

Blätter

blades

hojas

lames

lame

**35 mm**

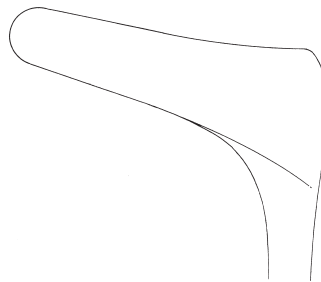

48-261-45-07

14 cm / 5 4/8"

Blätter

blades

hojas

lames

lame

**45 mm**

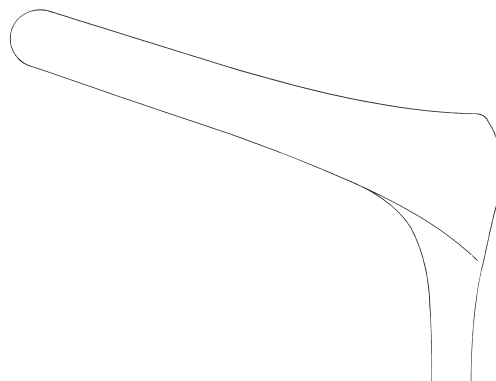

48-261-70-07

15,5 cm / 6 1/8"

Blätter

blades

hojas

lames

lame

**70 mm**



1/2

Tessier  
48-261-30-07 -  
48-261-70-07

SB

# Osteotome

Osteotomes  
Osteótomos  
Ostéotomes  
Osteotomo

# Kraniomaxillofaziale Chirurgie

Craniomaxillofacial surgery  
Cirugía cráneo-maxilofacial  
Chirurgie crânio-maxillofaciale  
Chirurgia cranio-maxillofaciale



1/2

Tessier  
48-270-02-07 -  
48-271-10-07  
16 cm / 6 2/8"

 1/4	 1/4	 1/4	 1/4
48-270-02-07 2 mm	48-270-03-07 3 mm	48-270-05-07 5 mm	48-270-07-07 7 mm
 1/4	 1/4	 1/4	
48-270-10-07 10 mm	48-270-14-07 14 mm	48-270-16-07 16 mm	
 1/4	 1/4	 1/4	
48-271-05-07 5 mm	48-271-07-07 7 mm	48-271-10-07 10 mm	

1/2

Tessier  
48-272-18-07  
16 cm / 6 2/8"

1/2

Tessier  
48-273-10-07  
18 cm / 7 1/8"

 1/4	 1/4
18 mm	10 mm

## Osteotome

Osteotomes  
Osteótomos  
Ostéotomes  
Osteotomo



## Tessier

48-274-10-07 - 48-275-15-07

20 cm / 7 7/8"

zur Transplantatentnahme aus Ilium und Tibia  
for taking grafts from ilium and tibia  
par sacar transplantes del ilion y la tibia  
pour prise de greffon de l'ilion et du tibia  
per prendere innesti dall'ileo e tibia

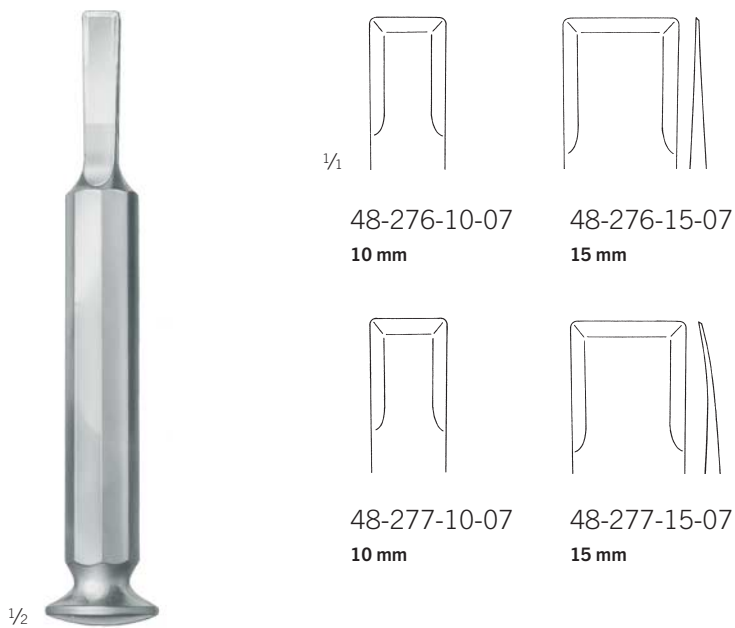

## Tessier

48-276-10-07 - 48-277-15-07

16 cm / 6 2/8"

zur Transplantatentnahme aus der Calva  
for taking grafts from the calva  
par sacar transplantes del calvo  
pour prise de greffon du crâne  
per prendere innesti dal calvo



## Thoraxhaken

Thoracic Retractors  
Separadores torácico  
Rétracteur thoracique  
Divaricatore per torace

## Kraniomaxillofaziale Chirurgie

Craniomaxillofacial surgery  
Cirugía cráneo-maxilofacial  
Chirurgie crânio-maxillofaciale  
Chirurgia cranio-maxillofaciale

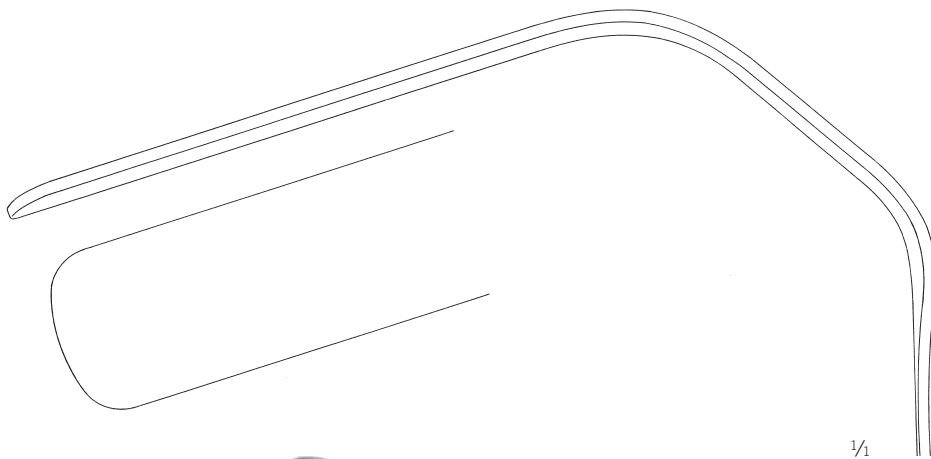

1/1

48-285-20-07

21 cm / 8 2/8"

90 x 22 mm

48-285-28-07

26,5 cm / 10 3/8"

120 x 28 mm



1/2

Tessier

48-285-20-07 -

48-285-28-07



## Beckenkamm spatel

Iliac Crest Retractors  
Separadores para cresta ilíaca  
Rétracteur iliaque  
Divaricatore per cresta iliaca

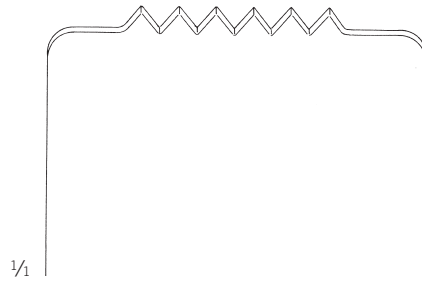

48-287-01-07  
16,5 cm / 6 4/8"  
36 x 50 mm

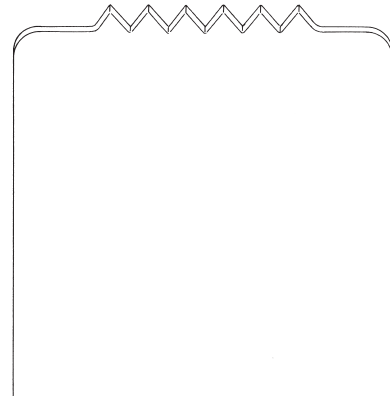

48-287-02-07  
17,5 cm / 6 7/8"  
52 x 50 mm

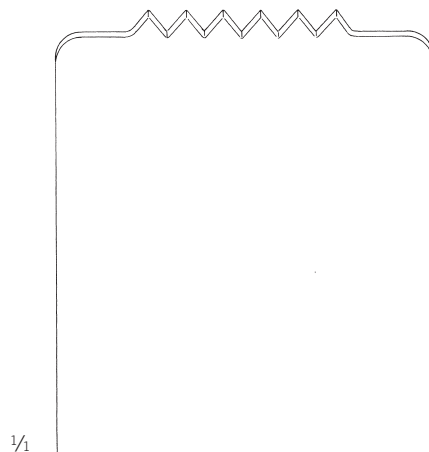

48-287-03-07  
17,5 cm / 6 7/8"  
59 x 50 mm

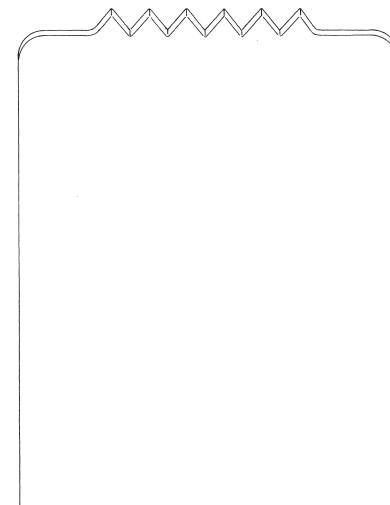

48-287-04-07  
18 cm / 7 1/8"  
66 x 50 mm



Tessier  
48-287-01-07 -  
48-287-04-07



## Knochenhaltezangen, Knochensplitterzangen, Periostaspatorien

Bone Holding Forceps, Bone Cutting Forceps, Periosteal Elevators

Pinzas para huesos, Cizallas para huesos, Legras para periostio

Pinces pour os, Pinces coupantes à os, Rugine-raspatoires pour périoste

Pinze per ossa, Pinze per ossa, Elevatori periostali

## Kraniomaxillofaziale Chirurgie

Craniomaxillofacial surgery

Cirugía cráneo-maxilofacial

Chirurgie crânio-maxillofaciale

Chirurgia cranio-maxillofaciale

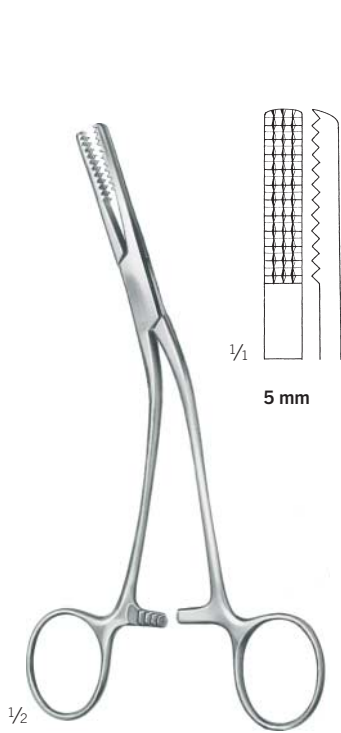

Tessier  
48-291-15-07  
16,5 cm / 6 1/8"

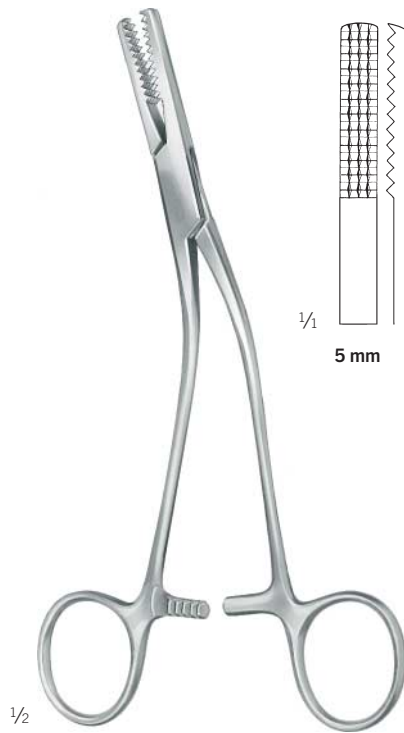

Tessier  
48-293-19-07  
18 cm / 7 1/8"



Tessier  
48-300-20-07  
18,5 cm / 7 3/8"  
schlankes Modell  
slender pattern  
modelo delgado  
modèle gracile  
modello delicato



Tessier  
48-301-21-07  
22 cm / 8 5/8"

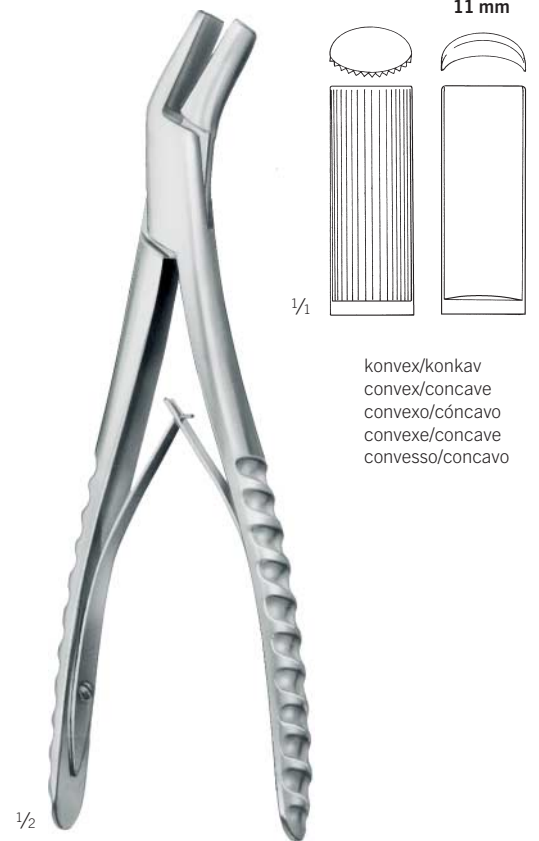

Tessier  
48-303-22-07  
22 cm / 8 5/8"

Knochenformzange  
Bone Contouring Forceps  
Pinza para formar huesos  
Pince pour former os  
Pinza per formare osso

konvex/konkav  
convex/concave  
convexo/cóncavo  
convexe/concave  
convesso/concavo

## Raspatorien

Periosteal Elevators  
Legras  
Rugines-raspatoires  
Elevatori per periosteo

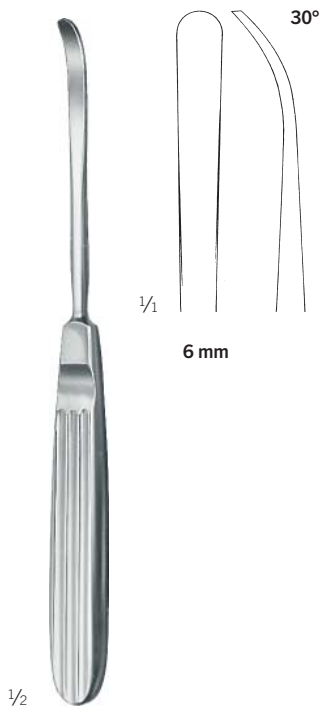

Tessier  
48-311-01-07  
18 cm / 7 1/8"

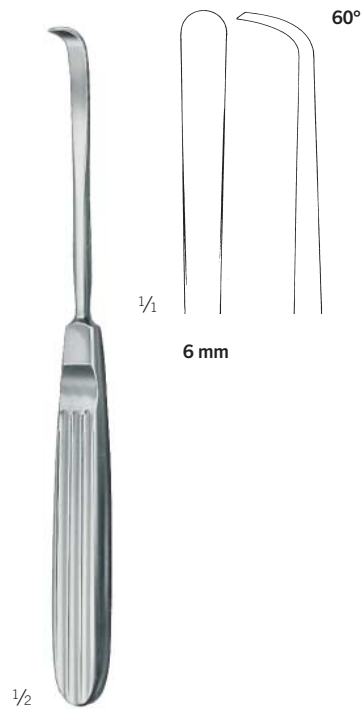

Tessier  
48-311-02-07  
18 cm / 7 1/8"

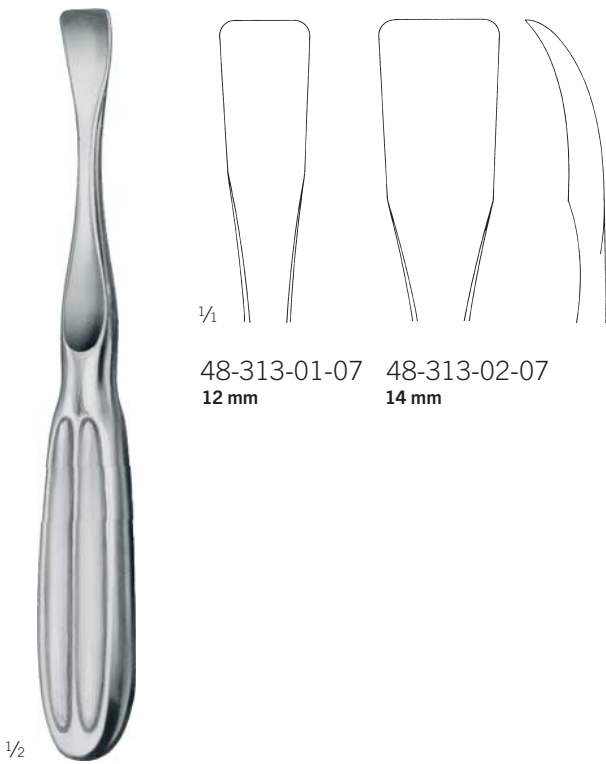

Tessier  
48-313-01-07-  
48-313-02-07  
20,5 cm / 8 1/8"



Tessier  
48-316-21-07  
21 cm / 8 2/8"  
Ø 2,5 mm



Tessier  
48-318-16-07  
16,5 cm / 6 4/8"  
Ø 4,5 mm



Tessier  
48-320-14-07  
14 cm / 5 4/8"  
Ø 2,0 mm

**Spatel**  
Spatula  
Espátulas  
Spatules  
Spatola

**Kraniomaxillofaziale Chirurgie**  
Craniomaxillofacial surgery  
Cirugía cráneo-maxilofacial  
Chirurgie crânio-maxillofaciale  
Chirurgia cranio-maxillofaciale



Tessier  
48-330-01-07

22 cm / 8 <sup>5</sup>/<sub>8</sub>"

**10 - 12 mm**

konisch, biegsam  
conical, malleable  
cónico, maleable  
conique, malléable  
conico, malleabili

SB



Tessier  
48-330-02-07

22 cm / 8 <sup>5</sup>/<sub>8</sub>"

**15 - 17 mm**

konisch, biegsam  
conical, malleable  
cónico, maleable  
conique, malléable  
conico, malleabili

SB



Tessier  
48-330-03-07

22 cm / 8 <sup>5</sup>/<sub>8</sub>"

**20 - 22 mm**

konisch, biegsam  
conical, malleable  
cónico, maleable  
conique, malléable  
conico, malleabili

SB

## Weichteilhaken

Soft Tissue Retractors

Separadores para partes blandas

Ecarteurs pour parties molles

Divaricatori per tessuti molli

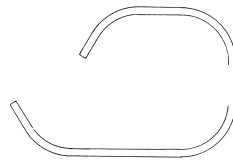

48-331-02-07

15 cm / 5 7/8"

20 x 13 / 30 x 15 mm

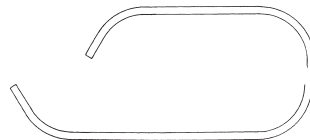

48-331-03-07

15,5 cm / 6 1/8"

28 x 13 / 36 x 15 mm

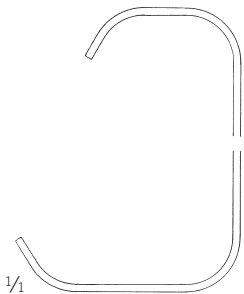

19 x 7 / 29 x 10 mm

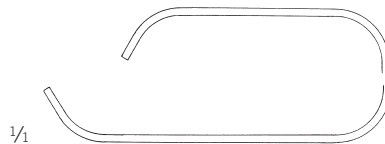

48-331-04-07

15,5 cm / 6 1/8"

33 x 12 / 43 x 15 mm

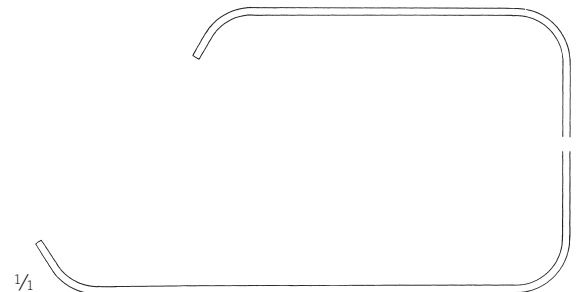

50 x 12 / 68 x 16 mm



Tessier  
48-331-01-07

15 cm / 5 7/8"

SB



Tessier  
48-331-02-07 -  
48-331-04-07

SB



Tessier  
48-331-05-07

16 cm / 6 2/8"

SB

## Weichteilhaken

Soft Tissue Retractors  
Separadores para partes blandas  
Ecarteurs pour parties molles  
Divaricatori per tessuti molli

## Kraniomaxillofaziale Chirurgie

Craniomaxillofacial surgery  
Cirugía cráneo-maxilofacial  
Chirurgie crânio-maxillofaciale  
Chirurgia cranio-maxillofaciale

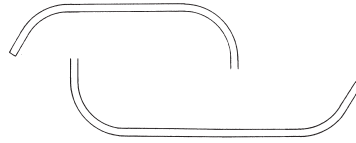

48-333-03-07

15 cm / 5 <sup>7</sup>/<sub>8</sub>"

30 x 12 / 38 x 16 mm

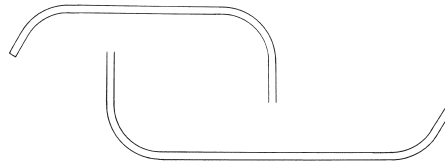

48-333-04-07

15 cm / 5 <sup>7</sup>/<sub>8</sub>"

35 x 12 / 45 x 16 mm

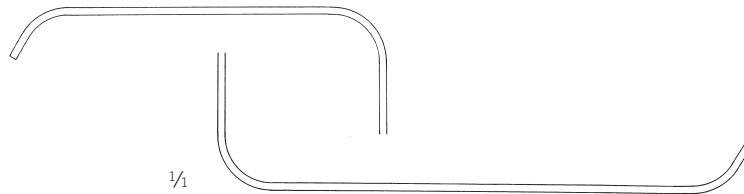

48-333-05-07

16 cm / 6 <sup>2</sup>/<sub>8</sub>"

50 x 12 / 70 x 16 mm

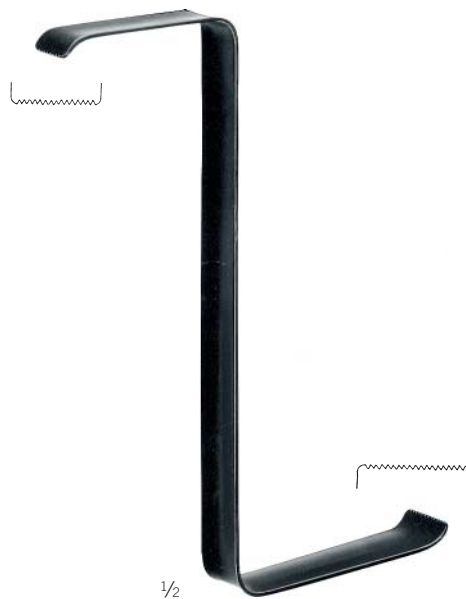

Tessier

48-333-03-07 -

48-333-05-07

SB

## Weichteilhaken

Soft Tissue Retractors

Separadores para partes blandas

Ecarteurs pour parties molles

Divaricatori per tessuti molli

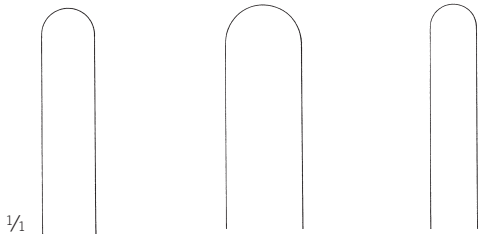

**Fig. 1**  
48-335-01-07  
8 mm

**Fig. 2**  
48-335-02-07  
10 mm

**Fig. 3**  
48-335-03-07  
7 mm

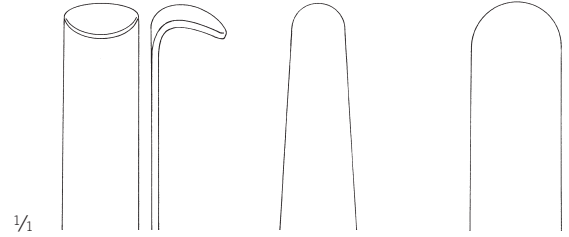

**Fig. 4**  
48-335-04-07  
10 mm

**Fig. 5**  
48-335-05-07  
8 mm

**Fig. 6**  
48-335-06-07  
12 mm



Tessier  
48-335-01-07 -  
48-335-03-07  
12,5 cm / 4 7/8"



Tessier  
48-335-04-07 -  
48-335-06-07  
12,5 cm / 4 7/8"





## Osteotome

Osteotomes  
Osteótomos  
Ostéotomes  
Osteotomo

## Kraniomaxillofaziale Chirurgie

Craniomaxillofacial surgery  
Cirugía cráneo-maxilofacial  
Chirurgie crânio-maxillofaciale  
Chirurgia cranio-maxillofaciale



Tessier  
48-340-18-07  
19 cm / 7 <sup>4</sup>/<sub>8</sub>"

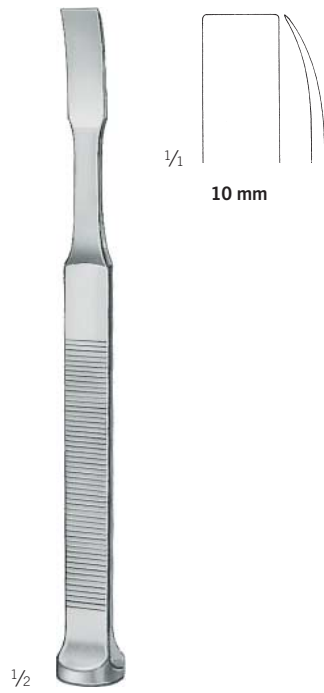

Tessier  
48-341-18-07  
18 cm / 7 <sup>1</sup>/<sub>8</sub>"

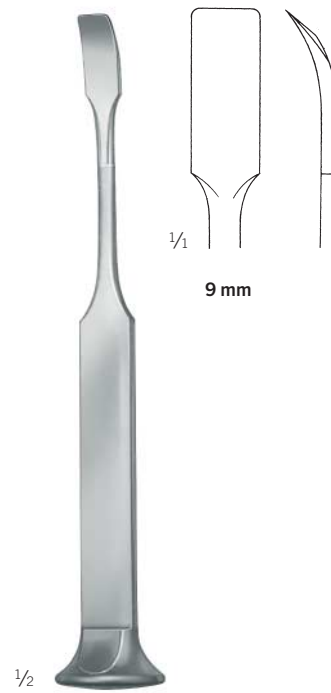

Tessier-Kawamoto  
48-345-18-07  
18 cm / 7 <sup>1</sup>/<sub>8</sub>"  
Retromaxillary chisel



48-350-24-07  
22 cm / 8 <sup>5</sup>/<sub>8</sub>"

## Präparierscheren, Drahtscheren

Dissecting Scissors, Wire Cutting Scissors

Tijeras para preparaciones, Tijeras para alambre

Ciseaux à dissection, Ciseaux à couper le fil

Forbici per dissezione, Tronchesino

### TC GOLD



Tessier  
48-351-13-07

13 cm / 5 1/8"

Unterminierschere  
Undermining Scissors  
Tijera para minar  
Ciseaux à tunéliser  
Forbici per tunnelare



Tessier  
48-352-14-07

15 cm / 5 7/8"

### TC GOLD

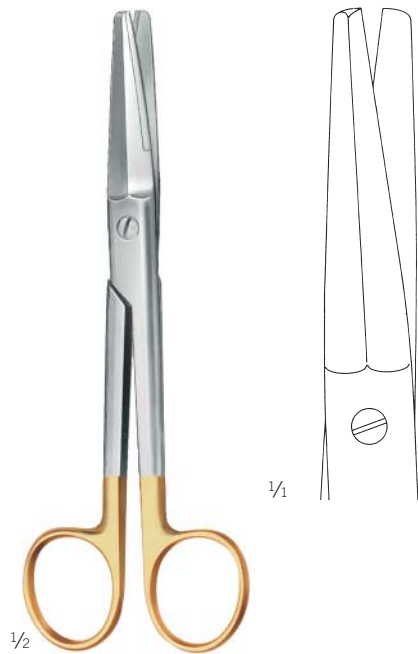

Tessier  
48-354-16-07

16,5 cm / 6 4/8"

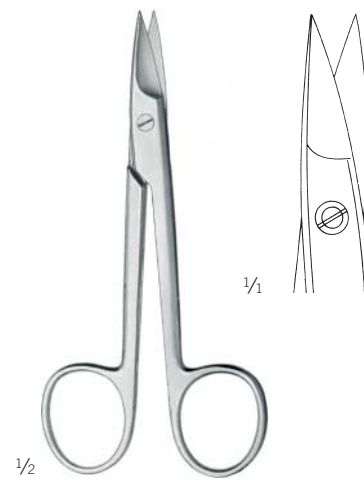

Tessier  
48-356-16-07

12 cm / 4 6/8"

## Repositionszangen

Disimpaction Forceps

Pinzas de reposición

Pince à repositionner

Pinze per riduzione

## Kraniomaxillofaziale Chirurgie

Craniomaxillofacial surgery

Cirugía cráneo-maxilofacial

Chirurgie crâno-maxillofaciale

Chirurgia cranio-maxillofaciale



1/2

Tessier  
48-360-01-07 -  
48-362-02-07  
23 cm / 9"

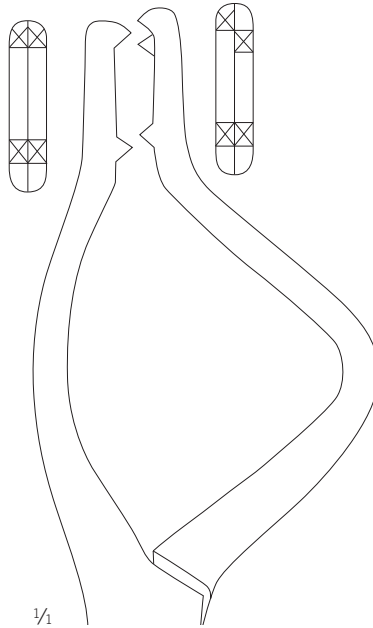

1/1

48-360-01-07

links, für Kinder  
left, for children  
izquierda, para niños  
gauche, pour enfants  
sinistra, per bambini

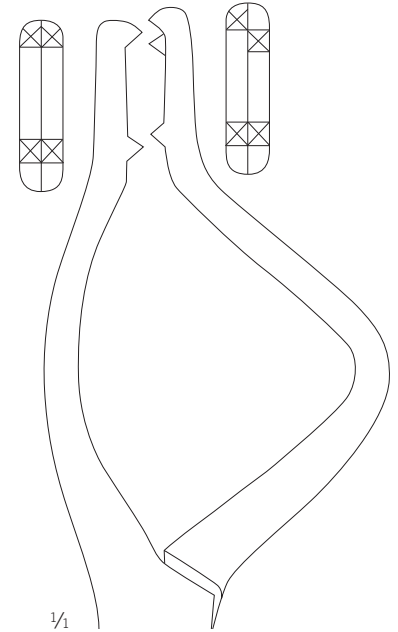

1/1

48-360-02-07

links, für Erwachsene  
left, for adults  
izquierda, para adultos  
gauche, pour adultes  
sinistra, per adulti

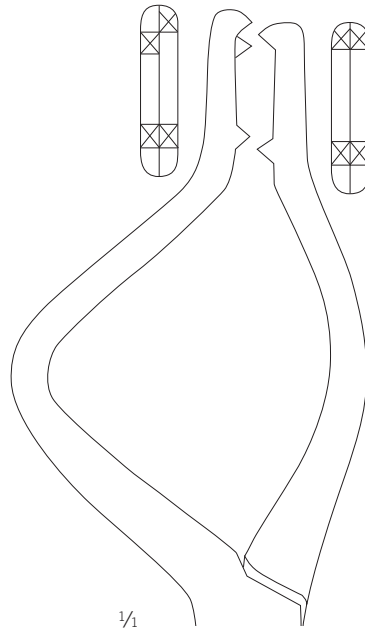

1/1

48-362-01-07

rechts, für Kinder  
right, for children  
derecha, para niños  
droite, pour enfants  
destraper bambini

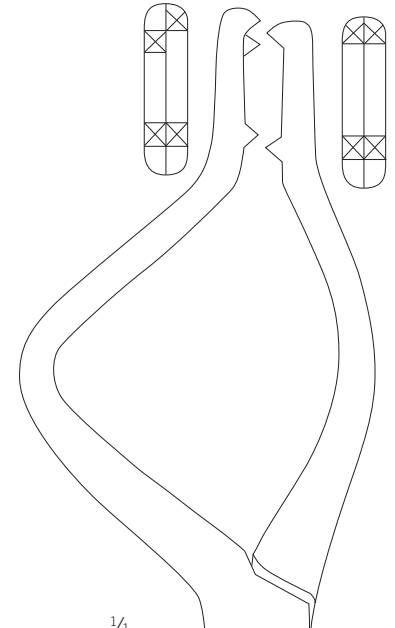

1/1

48-362-02-07

rechts, für Erwachsene  
right, for adults  
derecha, para adultos  
droite, pour adultes  
destra, per adulti

## Schieblehre, Knochenhaken

Caliper, Bone Hook  
Calibre, Gancho para huesos  
Calibre, Crochet pour os  
Calibro, Gancio per ossa



Tessier  
48-370-26-07  
26 cm / 10 <sup>2</sup>/<sub>8</sub>"  
Messbereich  
effective range  
alcance eficaz  
série effectif  
rango effective  
**200 mm**



Tessier  
48-371-18-07  
19 cm / 7 <sup>4</sup>/<sub>8</sub>"  
schwarz verchromt  
black chromium-plated  
cromado en negro  
chromé noir  
cromato nero

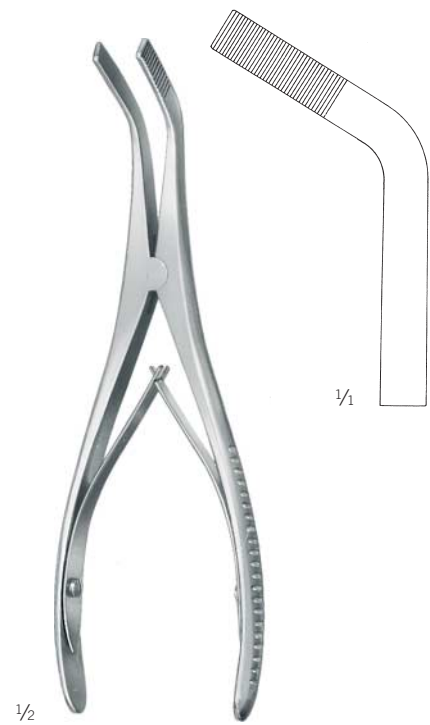

Tessier  
48-376-18-07  
17 cm / 6 <sup>6</sup>/<sub>8</sub>"  
Spreizzange  
Spreading Forceps  
Pinza de expansión  
Pince à écarter  
Pinze per allargare

## Mobilisierhaken, Raspatorien

Mobilizing Retractors, Periosteal Elevators  
 Separadores de mobilización, Periostótomos  
 Crochet de mobilisation, Rugines-raspatoires  
 Divaricatori per mobilizzazione, Periostotomi

## Kraniomaxillofaziale Chirurgie

Craniomaxillofacial surgery  
 Cirugía cráneo-maxilofacial  
 Chirurgie crânio-maxillofaciale  
 Chirurgia cranio-maxillofaciale

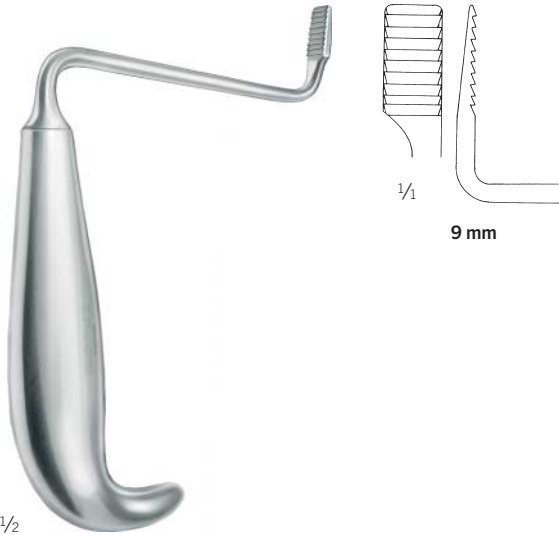

1/2  
**Tessier**  
**48-380-01-07**  
 15 cm / 5 7/8"  
 rechts  
 right  
 derecho  
 droit  
 destra

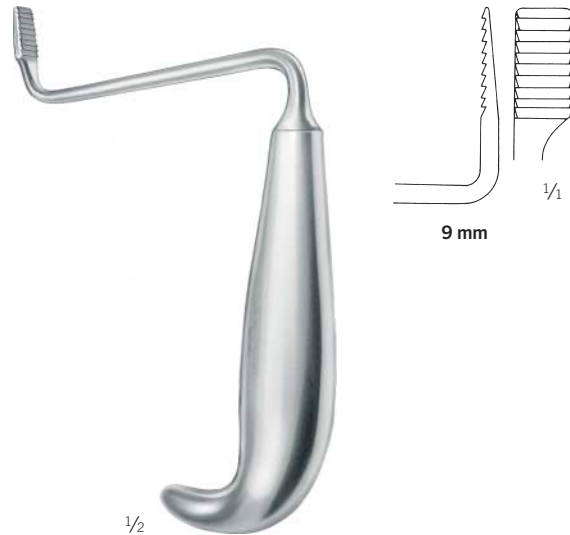

1/2  
**Tessier**  
**48-380-02-07**  
 15 cm / 5 7/8"  
 links  
 left  
 izquierdo  
 gauche  
 sinistra

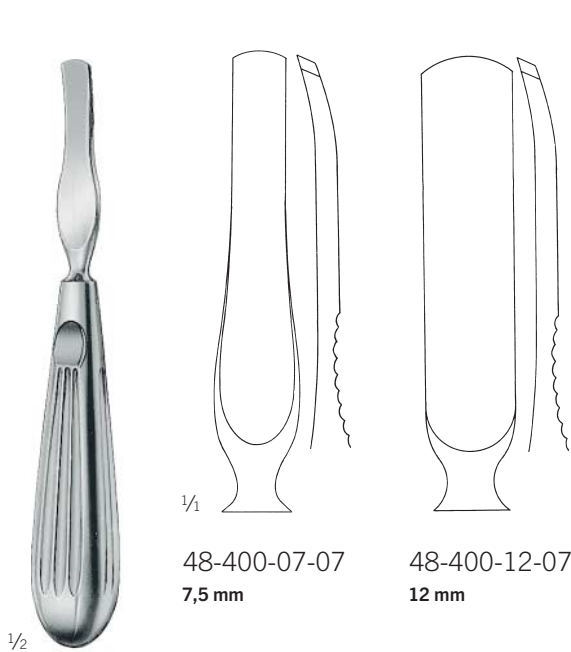

1/2  
**Marchac**  
**48-400-07-07 -**  
**48-400-12-07**  
 16 cm / 6 3/8"

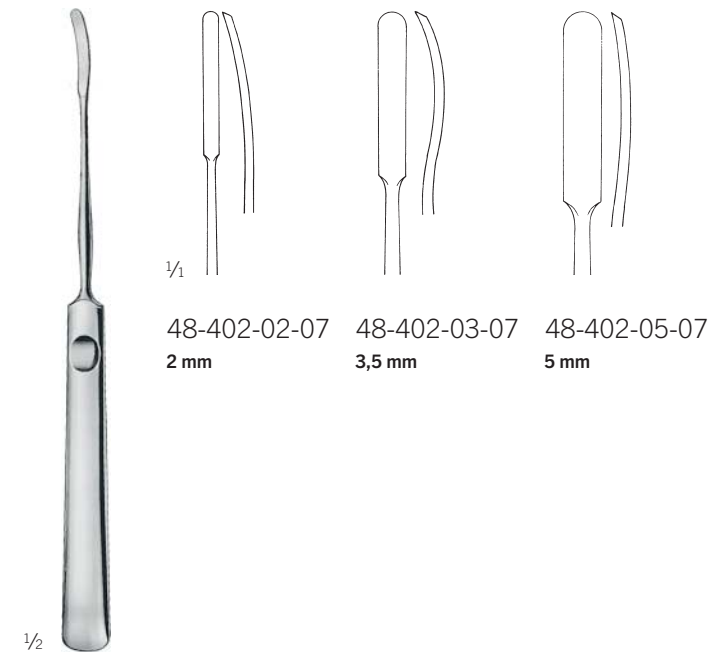

1/2  
**Marchac**  
**48-402-02-07 -**  
**48-402-05-07**  
 17 cm / 6 6/8"

## Schablonen, Messlehre, Elevatorien

Templates, Caliper, Elevators

Plantillas, Caliper, Elevadores

Gabarits, Calibre, Elévateurs

Sagome, Calibro, Elevatori



Marchac  
48-405-00-07

Frontschablonen  
Frontal Templates  
Plantillas frontales  
Gabarit frontal  
Sagome frontali  
für Kleinkinder  
for infants  
para bebés  
pour bébés  
per neonati



Marchac  
48-405-01-07

Frontschablonen  
Frontal Templates  
Plantillas frontales  
Gabarit frontal  
Sagome frontali  
für Kinder und Erwachsene  
for children and adults  
para niños y adultos  
pour enfants et adultes  
per bambini ed adulti



Marchac  
48-420-00-07

Messbereich  
effective range  
alcance eficaz  
série effectif  
rango effective  
**80 mm**



Steinberg  
48-500-18-07

18 cm / 7 1/8"

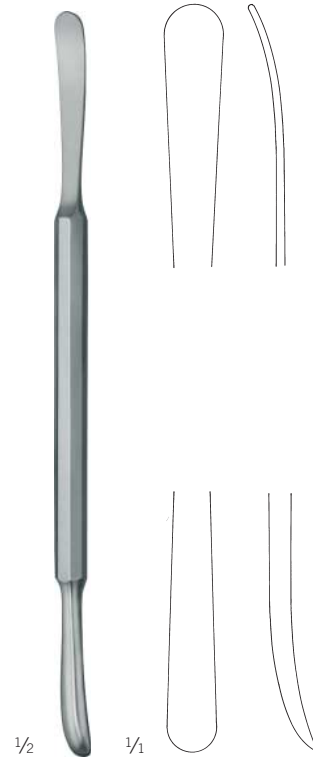

Steinberg  
48-506-20-07

19,5 cm / 7 5/8"

## Elevatorien

Elevators  
Elevadores  
Elévateurs  
Elevatori

## Kraniomaxillofaziale Chirurgie

Craniomaxillofacial surgery  
Cirugía cráneo-maxilofacial  
Chirurgie crânio-maxillofaciale  
Chirurgia cranio-maxillofaciale

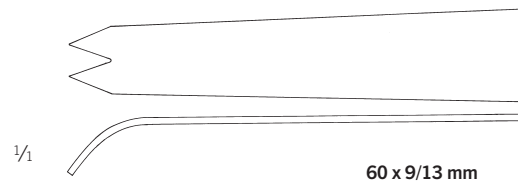

Steinberg  
48-525-23-07  
22,5 cm / 8 <sup>7</sup>/<sub>8</sub>"

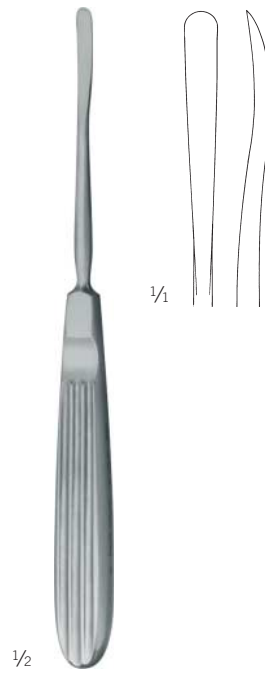

Steinberg  
48-531-19-07  
18,5 cm / 7 <sup>2</sup>/<sub>8</sub>"



Steinberg  
48-541-60-07  
22 cm / 8 <sup>5</sup>/<sub>8</sub>"

## Ösenzange

Eyelet forceps  
Alicate de orificios  
Pince de trous  
Pinza di fori

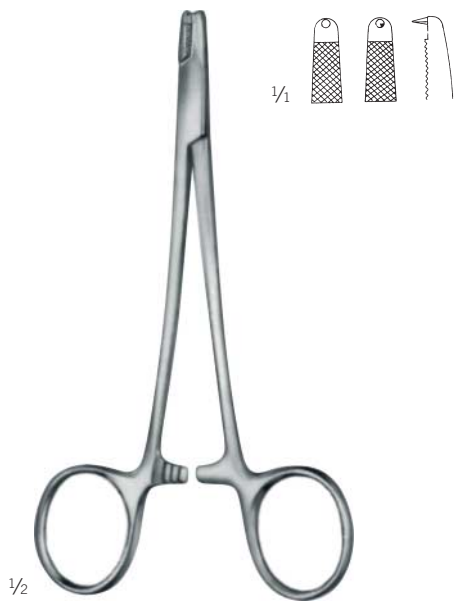
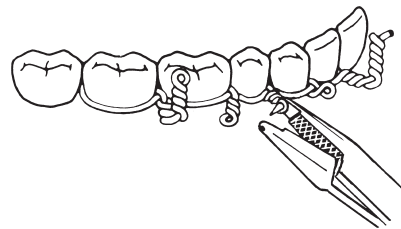
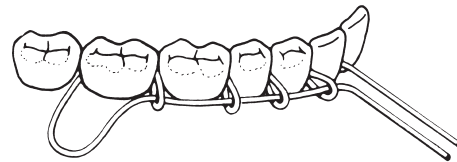
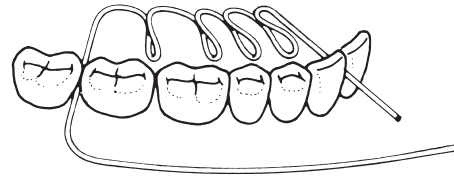

1/2

Obwegeser  
48-756-15-07  
15 cm / 5 7/8"



## Aspirations-Dissektor, Osteotome

Suction Dissector, Osteotomes  
 Disecador de aspiración, Osteótomos  
 Dissecteur à aspiration, Osteotomes  
 Dissettore a aspirazione, Osteotomi

## Kraniomaxillofaziale Chirurgie

Craniomaxillofacial surgery  
 Cirugía cráneo-maxilofacial  
 Chirurgie crânio-maxillofaciale  
 Chirurgia cranio-maxillofaciale



1/2

Marchac  
 50-430-19-07  
 19 cm / 7 1/8"



1/2

Marchac  
 50-440-04-07 -  
 50-440-08-07  
 18,5 cm / 7 3/8"

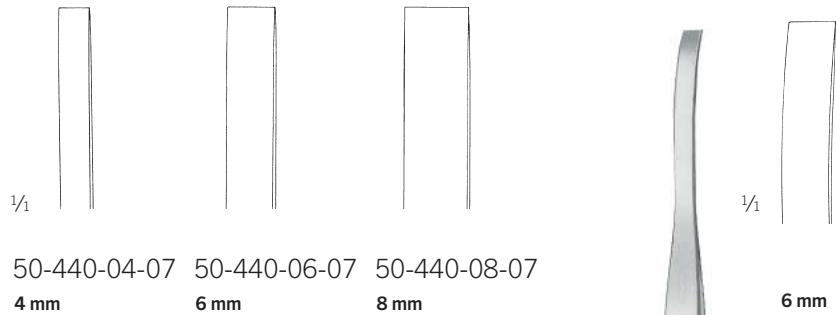

1/1

50-440-04-07

4 mm

50-440-06-07

6 mm

50-440-08-07

8 mm

1/1

6 mm



1/2

Marchac  
 50-446-19-07  
 20 cm / 7 7/8"



1/2

Marchac  
 50-450-17-07  
 17,5 cm / 6 7/8"  
 Knochensprezzange  
 Bone Expander  
 Pinza para separar huesos  
 Pince pour séparer os  
 Pinza per separare ossa

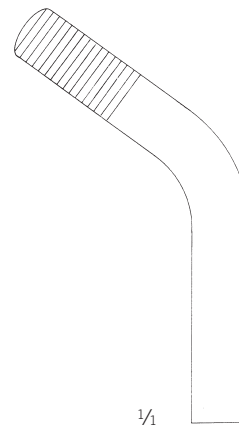

1/1

## Instrumentarium Arnett FAB Orthognathie-System

Instrumentation Arnett FAB Orthognathic System

Instrumental sistema ortognático FAB Arnett

Instruments Arnett pour système d'orthognathie FAB

Strumenti per sistema di ortognazia Arnett FAB



Arnett  
48-701-22-07

22 cm / 8 5/8"

Ramus-Elevatorium  
Ramus Elevator  
Elevador de rama  
Élévateur pour rama  
Elevatore per ramo



Arnett  
48-703-19-07

19 cm / 7 4/8"

Kürette  
Curette  
Cucharillas  
Curette  
Curette



Arnett  
48-704-22-07

20 cm / 7 7/8"

BSSO Lingual-Retraktor  
BSSO Lingual retractor  
Retractor lingual OSB  
Rétracteur lingual BSSO  
Separatore linguale BSSO

Fz

## Instrumentarium Arnett FAB Orthognathie-System

Instrumentation Arnett FAB Orthognathic System  
Instrumental sistema ortognático FAB Arnett  
Instruments Arnett pour système d'orthognathie FAB  
Strumenti per sistema di ortognazia Arnett FAB

## Kraniomaxillofaziale Chirurgie

Craniomaxillofacial surgery  
Cirugía cráneo-maxilofacial  
Chirurgie crânio-maxillofaciale  
Chirurgia cranio-maxillofaciale



Arnett  
48-705-14-07

20 cm / 7 7/8"

BSSO TMJ-Platzierer  
BSSO Condylar seating instrument  
Posicionador ATM OSB  
Instrument de positionnement ATM BSSO  
Posizionatore per TMJ BSSO



Arnett  
48-706-18-07

17 cm / 6 6/8"

Mandibular-Reaktor  
Mandibular body retractor  
Retractor mandibular  
Rétracteur pour mandibule  
Separatore mandibolare



Arnett  
48-707-14-07

16,5 cm / 6 4/8"

Maxilläre Sinus-Kürette  
Maxillary sinus curette  
Cureta para seno maxilar  
Curette pour sinus maxillaire  
Curetta per seno mascellare

# Instrumentarium Arnett FAB Orthognathie-System

Instrumentation Arnett FAB Orthognathic System

Instrumental sistema ortognático FAB Arnett

Instruments Arnett pour système d'orthognathie FAB

Strumenti per sistema di ortognazia Arnett FAB

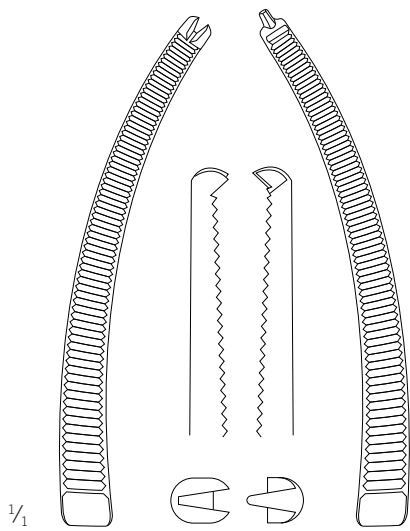

1/1



1/2

**Arnett**  
48-708-01-07

Koronoid-Reaktor  
Coronoid retractor  
Retractor de coronoides  
Rétracteur coronoïde  
Separatore per coronoide

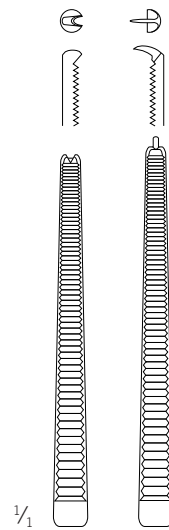

1/1

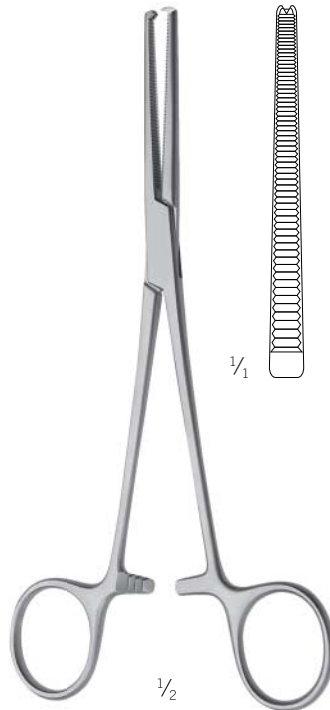

1/2

**Arnett**  
48-708-14-07

18,5 cm / 7 2/8"  
Knochenklemme  
Bone Forceps  
Pinza para huesos  
Pince pour os  
Pinza per ossa

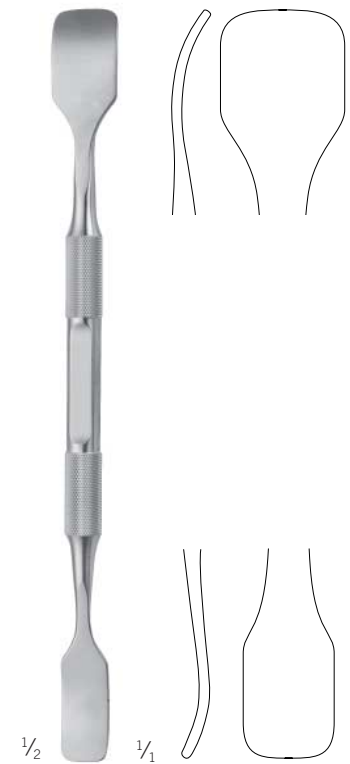

1/2

1/1

**Arnett**  
48-709-18-07

20 cm / 7 7/8"  
Le Fort I Posterior-Reaktor  
Le Fort I posterior retractor  
Retractor posterior Le Fort I  
Le Fort I Rétracteur postérieur  
Separatore posteriore Le Fort I

## Instrumentarium Arnett FAB Orthognathie-System

Instrumentation Arnett FAB Orthognathic System  
 Instrumental sistema ortognático FAB Arnett  
 Instruments Arnett pour système d'orthognathie FAB  
 Strumenti per sistema di ortognazia Arnett FAB

## Kraniomaxillofaziale Chirurgie

Craniomaxillofacial surgery  
 Cirugía cráneo-maxilofacial  
 Chirurgie crânio-maxillofaciale  
 Chirurgia cranio-maxillofaciale

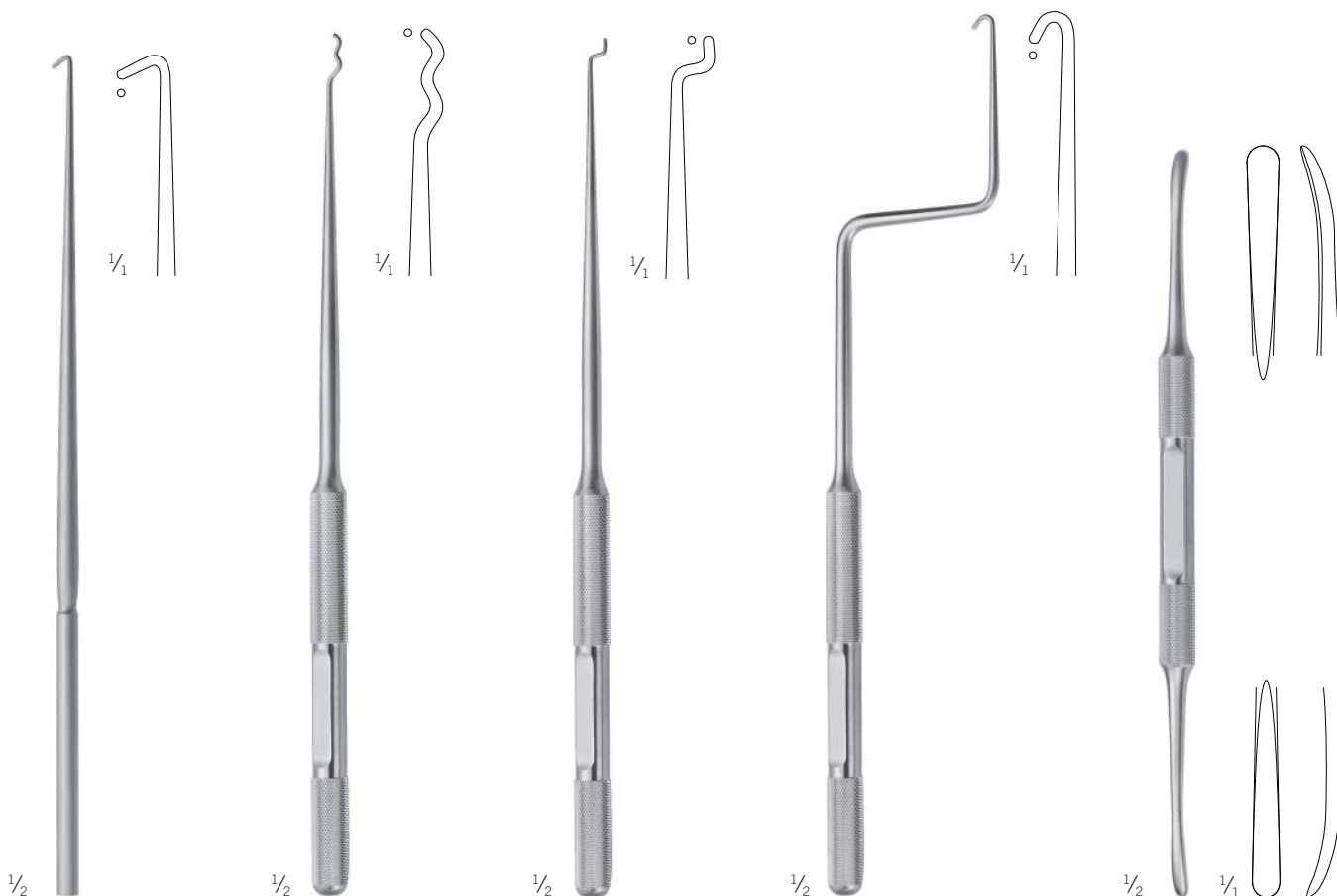
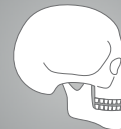

### Arnett 48-711-22-07

22,5 cm / 8 7/8"  
 DBSSO / Le Fort I  
 Nerv-Dissektor  
 BSSO / Le Fort I  
 Nerve dissector  
 Disecador para  
 nervios OSB / Le Fort I  
 DBSSO / Le Fort I  
 Dissecteur de nerf  
 Dissettore per nervi  
 BSSO / Le Fort I

### Arnett 48-711-23-07

23 cm / 9"  
 BSSO Alveolarnerv-  
 Dissektor  
 BSSO Alveolar  
 nerve dissector  
 Disecador para  
 nervio alveolar OSB  
 Dissecteur de nerf  
 alvéolaire BSSO  
 Dissettore per nervo  
 alveolare BSSO

### Arnett 48-711-24-07

23 cm / 9"  
 BSSO Alveolarnerv-  
 Dissektor  
 BSSO Alveolar  
 nerve dissector  
 Disecador para  
 nervio alveolar OSB  
 Dissecteur de nerf  
 alvéolaire BSSO  
 Dissettore per nervo  
 alveolare BSSO

### Arnett 48-711-25-07

23 cm / 9"  
 Le Fort I / BSSO Retraktor  
 für Inzissionsverschluss  
 Le Fort I / BSSO Retractor  
 for incision closure  
 Retractor Le Fort I /  
 OSB para cierre de incisiones  
 Le Fort I / Rétracteur BSSO  
 pour fermeture d'incision  
 Separatore Le Fort I /  
 BSSO per chiusura incisione

### Arnett 48-712-12-07

20 cm / 7 7/8"  
 Le Fort I Septum-  
 Elevatorium  
 Le Fort I Septum  
 elevator  
 Elevador para  
 septo Le Fort I  
 Le Fort I Élévateur  
 pour septum  
 Elevatore setto  
 Le Fort I

## Instrumentarium Arnett FAB Orthognathie-System

Instrumentation Arnett FAB Orthognathic System

Instrumental sistema ortognático FAB Arnett

Instruments Arnett pour système d'orthognathie FAB

Strumenti per sistema di ortognazia Arnett FAB



Arnett  
48-714-20-07

19,5 cm / 7 <sup>5</sup>/<sub>8</sub>"

BSSO Nerv-Retractor  
BSSO Nerve retractor  
Retractor para nervios OSB  
Rétracteur de nerf BSSO  
Separatore nervi BSSO

Arnett  
48-715-42-07

22,5 cm / 8 <sup>7</sup>/<sub>8</sub>"

Le Fort I Oberlippen-Retractor  
Le Fort I Upper lip retractor  
Retractor para labio superior Le Fort I  
Le Fort I Écarteur pour lèvre supérieure  
Separatore labbro superiore Le Fort I

Arnett  
48-716-22-07 - 48-716-55-07

22,5 cm / 8 <sup>7</sup>/<sub>8</sub>"

Wangen- und Lippen-Retractor  
Cheek / lip retractor  
Retractor para mejillas y labios  
Écarteur des lèvres et joues  
Separatore per guance e labbra

## Instrumentarium Arnett FAB Orthognathie-System

Instrumentation Arnett FAB Orthognathic System  
Instrumental sistema ortognático FAB Arnett  
Instruments Arnett pour système d'orthognathie FAB  
Strumenti per sistema di ortognazia Arnett FAB

## Kraniomaxillofaziale Chirurgie

Craniomaxillofacial surgery  
Cirugía cráneo-maxilofacial  
Chirurgie crânio-maxillofaciale  
Chirurgia cranio-maxillofaciale



6,5 x 45 mm

1/2

Arnett  
48-717-42-07  
22 cm / 8 5/8"

Kinnosteotomie-Retraktor  
Chin osteotomy retractor  
Retractor para osteotomía mentoniana  
Rétracteur pour génioplastie  
Separatore per osteotomia del mento

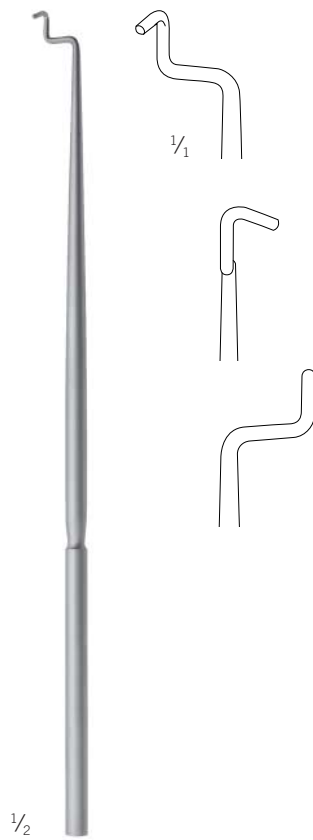

1/2

Arnett  
48-723-22-07  
22 cm / 8 5/8"

Le Fort I Interdental-Retraktor  
Le Fort I Interdental retractor  
Retractor interdental Le Fort I  
Le Fort I Rétracteur interdentaire  
Separatore interdendale Le Fort I

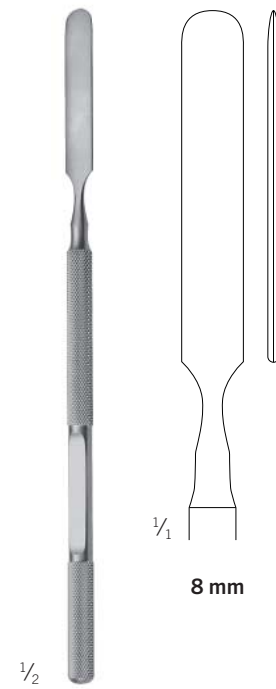

1/2

Arnett  
48-725-18-07  
18 cm / 7 1/8"

Interdental-Osteotom  
Interdental osteotome  
Osteótomo interdental  
Ostéotome interdentaire  
Osteotomo interdendale

## Instrumentarium Arnett FAB Orthognathie-System

Instrumentation Arnett FAB Orthognathic System

Instrumental sistema ortognático FAB Arnett

Instruments Arnett pour système d'orthognathie FAB

Strumenti per sistema di ortognazia Arnett FAB



Arnett  
48-726-08-07 -  
48-726-15-07  
22 cm / 8 5/8"  
BSSO Split-Osteotom  
BSSO splitting osteotome  
Osteótomo Split OSB  
Ostéotome de dédoublement BSSO  
Osteotomo BSSO

Arnett  
48-727-20-07  
20 cm / 7 7/8"  
Hammer  
Mallet  
Martillo  
Maillets  
Martello

Arnett  
48-728-18-07  
18 cm / 7 1/8"  
Pterygoid-Osteotom  
Pterygoid osteotome  
Osteótomo pterigoideo  
Ostéotome ptérygoïde  
Osteotomo per pterigoido

Fz



## Instrumentarium Arnett FAB Orthognathie-System

Instrumentation Arnett FAB Orthognathic System  
Instrumental sistema ortognático FAB Arnett  
Instruments Arnett pour système d'orthognathie FAB  
Strumenti per sistema di ortognazia Arnett FAB

## Kraniomaxillofaziale Chirurgie

Craniomaxillofacial surgery  
Cirugía cráneo-maxilofacial  
Chirurgie crânio-maxillofaciale  
Chirurgia cranio-maxillofaciale

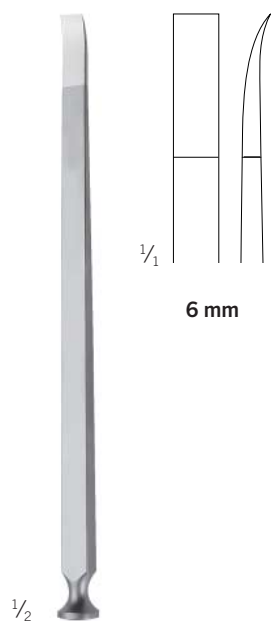
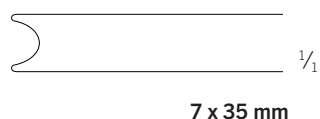

Arnett  
48-728-19-07

16 cm / 6 2/8"

BSSO Split-Osteotom  
BSSO Splitting osteotome  
Osteótomo Split OSB  
Ostéotome de dédoublement BSSO  
Osteotomo BSSO



Arnett  
48-729-55-07

22 cm / 8 5/8"

BSSO Transoral-Retraktor  
BSSO Transoral retractor  
Retractor transoral OSB  
Rétracteur transoral BSSO  
Separatore transorale BSSO



Arnett  
48-731-14-07

14,5 cm / 5 6/8"

Meßschieber  
Caliper  
Calibre  
Calibre  
Calibro a corsoio

## Instrumentarium Arnett FAB Orthognathie-System

Instrumentation Arnett FAB Orthognathic System

Instrumental sistema ortognático FAB Arnett

Instruments Arnett pour système d'orthognathie FAB

Strumenti per sistema di ortognazia Arnett FAB

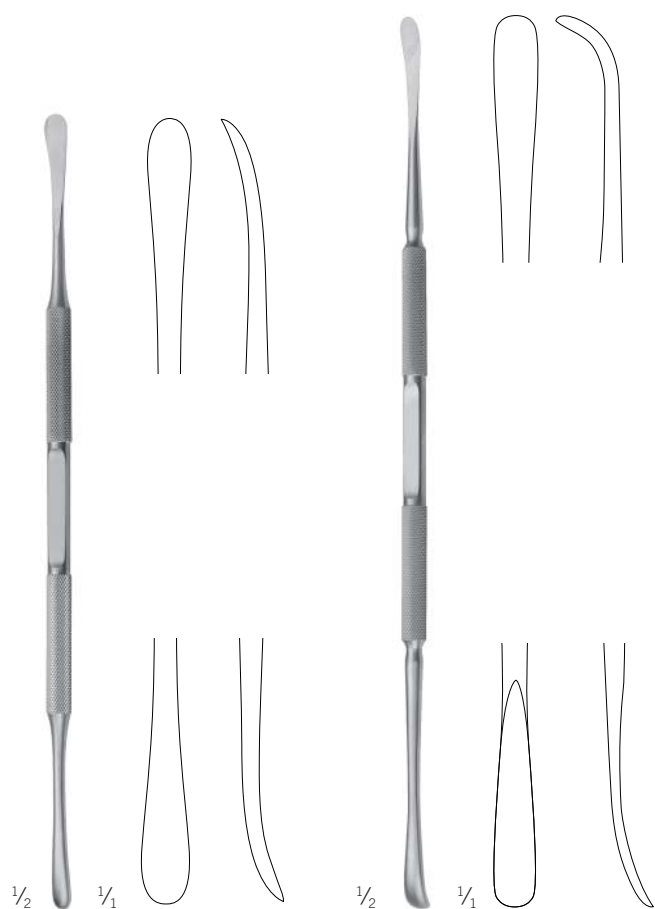

Arnett  
48-731-22-07

21 cm / 8 2/8"

Periostelevator  
Periosteal elevator  
Elevador perióstico  
Élévateur à périoste  
Elevatore per perioste



Arnett  
48-731-25-07

24 cm / 9 4/8"

Periostelevator  
Periosteal elevator  
Elevador perióstico  
Élévateur à périoste  
Elevatore per perioste



Arnett  
48-735-19-07

19 cm / 7 4/8"

Retraktor für Kinnosteotomie  
Midline flap retractor  
Retractor para osteotomía mentoniana  
Rétracteur pour génioplastie  
Separatore per osteotomia del mento

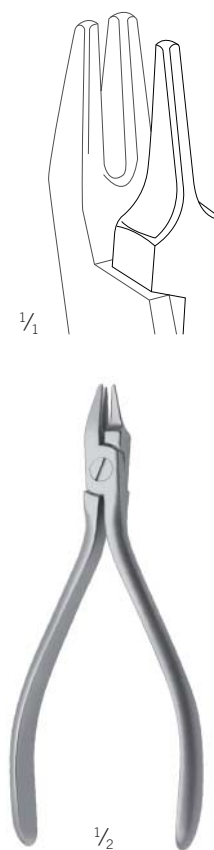

Arnett  
48-738-12-07

12,5 cm / 4 7/8"

Plattenbiegezange  
Plate bending forceps  
Alicate para doblar placas  
Pince de pliage  
Pinza per piegare placche

## Instrumentarium Arnett FAB Orthognathie-System

Instrumentation Arnett FAB Orthognathic System  
Instrumental sistema ortognático FAB Arnett  
Instruments Arnett pour système d'orthognathie FAB  
Strumenti per sistema di ortognazia Arnett FAB

## Kraniomaxillofaziale Chirurgie

Craniomaxillofacial surgery  
Cirugía cráneo-maxilofacial  
Chirurgie crânio-maxillofaciale  
Chirurgia cranio-maxillofaciale

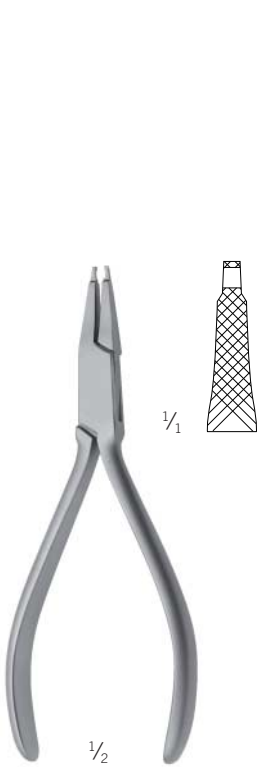

Arnett  
48-738-13-07

13 cm / 5 1/8"

Le Fort I Plattenbiegezange  
Le Fort I Plate bending forceps  
Alicate para doblar placas Le Fort I  
Le Fort I Pince de pliage  
Pinza per piegare placche Le Fort I

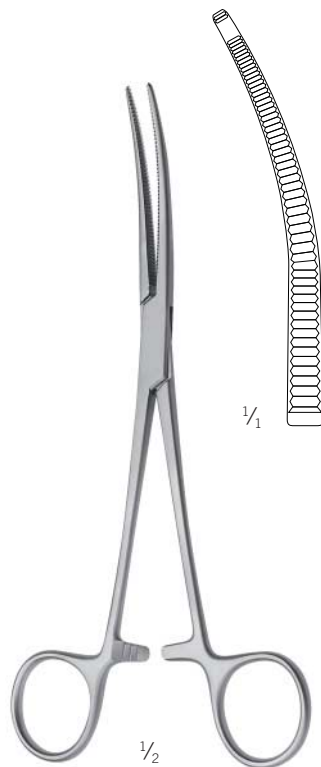

Arnett  
48-739-18-07

18,5 cm / 7 2/8"

Plattenhalteklemme  
Plate carrier  
Pinza para sujetar placas  
Pince de maintien  
Pinza ferma-placche

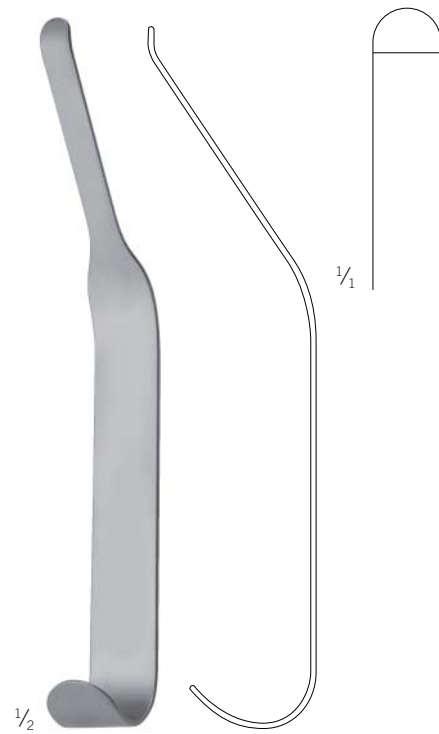

Arnett  
48-740-20-07

18,5 cm / 7 2/8"

Le Fort I Retraktor für nasale Mukosa  
Le Fort I Nasal mucosa retractor  
Retractor Le Fort I para mucosa nasal  
Le Fort I Rétracteur pour muqueuse nasale  
Separatore Le Fort I per mucosa nasale

## Sagittale Ramusosteotomie nach Lindorf

Sagittal ramus osteotomies acc. to Lindorf

Osteotomía sagital de rama mandibular según Lindorf

Ostéotomie sagittale du ramus selon Lindorf

Osteotomia sagittale del ramo secondo Lindorf

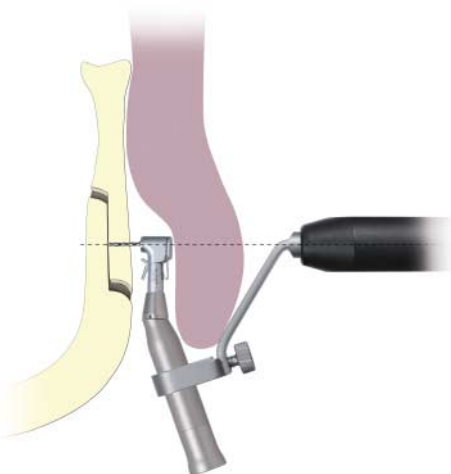
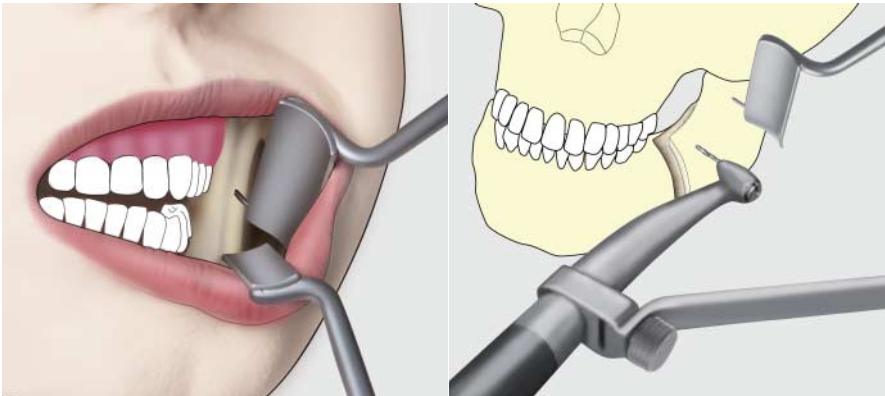

1/2

Lindorf  
50-840-00-07

18 cm / 7 1/8"

Enorale Bohr- und Schraubhilfe  
Enoral drilling and screwing aid  
Ayuda per perforar y atornillar  
Aide de forage et vissage  
Aiuto per perforare e avvitare

## Sagittale Ramusosteotomie nach Lindorf

Sagittal ramus osteotomies acc. to Lindorf  
 Osteotomía sagital de rama mandibular según Lindorf  
 Ostéotomie sagittale du ramus selon Lindorf  
 Osteotomia sagittale del ramo secondo Lindorf

## Kraniomaxillofaziale Chirurgie

Craniomaxillofacial surgery  
 Cirugía cráneo-maxilofacial  
 Chirurgie crânio-maxillofaciale  
 Chirurgia cranio-maxillofaciale

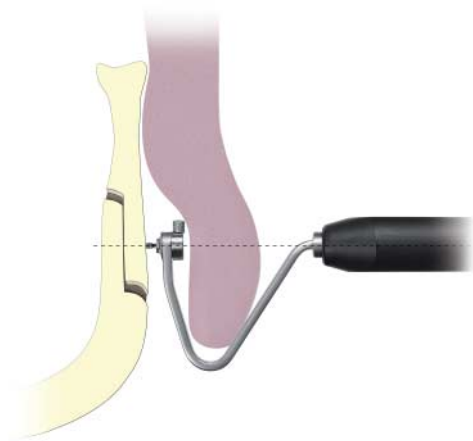
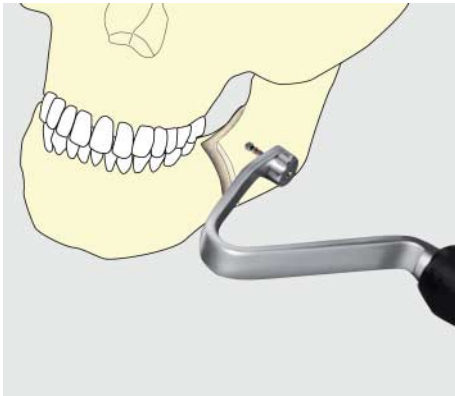

Einsätze für Schrauben  
 Blades for screws  
 Terminales para tornillos  
 Lames pour vis  
 Lame per viti

Centre Drive®	
1,5 mm	● ⊕ 50-910-15-07
2,0/2,3 mm	● ⊕ 50-910-20-07
Cross Drive	
1,5 mm	● ⊕ 50-915-15-07
2,0/2,3 mm	● ⊕ 50-915-20-07
2,7 mm	○ ⊕ 50-915-27-07

1/2

Lindorf  
 50-841-00-07  
 18 cm / 7 1/8"

Explantationsinstrument  
 Explantation instrument  
 Instrument para explantacion  
 Instrument d'explantaton  
 Strumento per espianzazione

## Weitere Produkte

Additional Products  
Productos adicionales  
Produits supplémentaires  
Prodotti aggiuntivi

In unserem Hauptkatalog finden Sie eine große Auswahl von Scheren, Pinzetten, Nadelhalter und Standard Wundhaken

Our main catalog contains a wide selection of scissors, tweezers, needle holders and standard surgical retractors.

En nuestro catálogo principal encontrará una amplia selección de tijeras, pinzas, porta-agujas y separadores estándar

Notre catalogue général contient une large variété de ciseaux, pinces, porte-aiguilles et écarteurs standard

Nel nostro catalogo generale è disponibile un'ampia scelta di forbici, pinzette, portaaghi e divaricatori standard

Unser Ordner-System „CMF Osteosynthesis“ enthält die gesamte Palette der KLS-Martin-Implantate und -Instrumente für die Mund-, Kiefer- und Gesichtschirurgie.

Our folder system “CMF Osteosynthesis” contains the full range of KLS-Martin implants and instruments for cranio-Craniomaxillofacial surgery.

Nuestro sistema de carpetas “CMF Osteosynthesis” incluye la gama completa de implantes e instrumentos de KLS-Martin para la cirugía oral y maxilofacial.

Notre système de dossiers «CMF Osteosynthesis» contient l'ensemble de la palette des implants et instruments KLS Martin pour la chirurgie buccale et maxillofaciale.

Il nostro sistema di cartelle “CMF Osteosynthesis” contiene la gamma completa degli impianti e degli strumenti di KLS Martin per la chirurgia orale-maxillo-facciale.

Unser Katalog „Dental/Oral“ enthält die gesamte Palette der KLS-Martin-Dental-Instrumente.

Our catalog “Dental/Oral” contains the full range of KLS-Martin dental instruments.

Nuestro catálogo “Dental/Oral” incluye la gama completa de instrumentos dentales de KLS-Martin.

Notre catalogue «Dental/Oral» contient l'ensemble de la palette des instruments dentaires KLS Martin.

Il nostro catalogo “Dental/Oral” contiene la gamma completa degli strumenti dentali di KLS Martin.

Informationen zu den KLS-Martin-Distraktoren entnehmen Sie bitte den separaten Broschüren.

Please refer to the separate brochures for information about KLS-Martin distactors.

Encontrará información sobre los dispositivos de distracción de KLS-Martin en los folletos específicos.

Veillez vous reporter aux brochures séparées pour obtenir des informations détaillées à propos des dispositifs de distraction KLS Martin.

Per informazioni sui distrattori di KLS Martin, consultare le brochure separate.

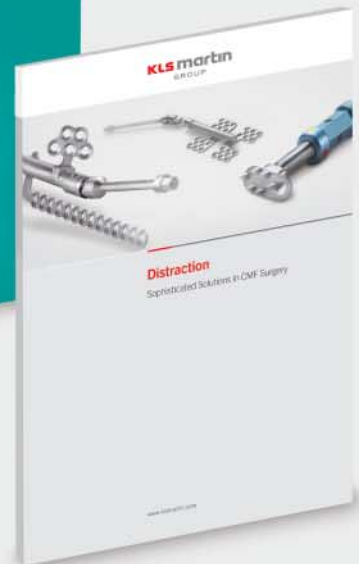
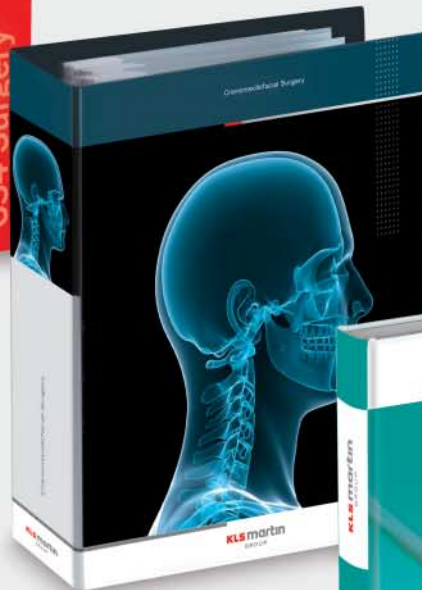





---

Nummern-Index  
Index of order numbers  
Índice de números de referencia  
Index numérique des références de commande  
Elenco dei codici



## Nummern-Index

Index of order numbers

Índice de números de referencia

Index numérique des références de commande

Elenco dei codici

### 11

11-765-18-07	2
11-767-18-07	2
11-769-18-07	2

### 12

12-276-18-07	3
12-278-18-07	3
12-279-18-07	3

### 15

15-318-01-07	6
15-318-02-07	6
15-716-01-07	10
15-716-03-07	10

### 20

20-610-18-07	4
--------------	---

### 35

35-133-06-07	14
35-133-07-07	14
35-133-09-07	14
35-134-09-07	14
35-134-18-07	14
35-135-18-07	14

### 37

37-544-03-07	8
37-544-04-07	8
37-544-05-07	9
37-544-06-07	9

### 38

38-011-16-07	16
38-012-16-07	16
38-013-13-07	16
38-014-00-07	16
38-050-45-09	17
38-050-65-09	17
38-050-80-09	17
38-051-45-07	17
38-103-01-02	18
38-111-02-02	18
38-120-10-04	18
38-127-02-04	18
38-130-50-07	18
38-130-52-07	18
38-130-54-07	18
38-130-56-07	18
38-130-58-07	18
38-130-90-98	18
38-140-13-07	19
38-161-11-07	19

38-161-14-07	19
38-161-92-98	19
38-161-93-98	19
38-171-12-07	19
38-179-16-07	19
38-179-20-07	19
38-196-00-07	20
38-198-00-07	20, 21
38-198-01-07	21
38-198-02-07	21
38-198-03-07	21
38-198-10-07	21
38-198-90-98	21
38-208-00-07	22
38-208-01-07	22
38-208-02-07	22
38-208-03-07	22
38-208-10-07	22
38-212-00-07	23
38-212-01-07	23
38-212-02-07	23
38-212-03-07	23
38-212-04-07	23
38-212-05-07	23
38-212-10-07	23
38-212-50-07	23
38-212-90-98	23
38-222-00-07	24
38-222-01-07	24
38-222-02-07	24
38-222-03-07	24
38-222-10-07	24
38-224-00-07	25
38-224-01-07	25
38-224-02-07	25
38-224-03-07	25
38-237-09-07	26
38-237-11-07	26
38-237-13-07	26
38-237-15-07	26
38-240-00-07	26
38-240-01-07	26
38-240-02-07	26
38-240-03-07	26
38-240-13-07	26
38-243-11-01	27
38-246-14-04	27
38-249-14-01	27
38-251-12-07	27
38-261-13-01	27
38-263-15-01	27
38-265-00-01	27
38-271-15-07	28
38-277-14-07	28
38-281-14-07	28
38-297-01-01	28
38-297-02-01	28
38-350-16-04	29
38-352-15-04	29
38-375-13-01	29

38-375-16-01	29
38-385-19-01	29
38-405-02-07	30
38-405-03-07	30
38-452-17-07	31
38-467-17-07	31
38-468-02-04	31
38-501-24-01	32
38-502-24-01	32
38-503-27-01	33
38-504-27-01	33
38-505-24-01	34
38-507-27-01	34
38-509-21-01	35
38-511-21-01	35
38-513-24-01	35
38-515-24-01	35
38-517-25-01	36
38-519-28-01	36
38-520-01-07	38
38-520-02-07	38
38-520-03-07	39
38-520-04-07	39
38-520-28-01	36
38-523-24-01	37
38-525-01-07	40
38-525-02-07	41
38-526-01-07	40
38-526-02-07	41
38-527-01-07	42
38-527-02-07	42
38-603-40-07	43
38-603-55-07	43
38-603-80-07	43
38-605-22-07	43
38-607-22-07	44
38-611-16-07	44
38-613-08-07	44
38-613-10-07	44
38-614-10-07	45
38-614-20-07	45
38-616-01-07	46
38-616-02-07	46
38-616-10-07	47
38-616-20-07	47
38-618-01-07	48
38-618-02-07	48
38-618-10-07	49
38-618-20-07	49
38-620-10-07	50
38-620-20-07	50
38-630-06-07	51
38-630-07-07	51
38-630-09-07	51
38-630-11-07	51
38-631-05-07	51
38-631-07-07	51
38-631-09-07	51
38-632-01-07	52
38-632-02-07	52

38-633-01-07	52
38-633-02-07	52
38-633-03-07	52
38-633-04-07	52
38-640-21-07	53
38-642-21-07	53
38-684-01-07	7
38-684-02-07	7
38-684-03-07	11
38-684-04-07	11
38-685-00-07	53
38-688-15-07	53
38-690-00-07	53
38-691-01-07	54
38-691-02-07	54
38-693-19-07	54
38-694-20-07	54
38-695-20-07	55
38-696-20-07	55
38-697-01-07	55
38-697-02-07	55
38-700-01-07	56
38-700-02-07	56
38-700-03-07	56
38-701-01-07	56
38-701-02-07	56
38-701-03-07	56
38-711-01-01	57
38-711-02-01	57
38-711-21-07	57
38-713-21-07	57
38-715-19-07	58
38-715-21-07	58
38-715-22	7
38-718-01-07	58
38-718-02-07	58
38-719-01-07	59
38-719-02-07	59
38-720-01-07	59
38-720-02-07	59
38-722-25-07	60
38-723-16-07	60
38-725-01-07	61
38-725-02-07	61
38-725-03-07	61
38-725-04-07	61
38-731-12-07	62
38-733-13-07	62
38-737-17-07	62
38-739-14-07	62
38-741-01-07	63
38-741-02-07	63
38-741-03-07	63
38-745-01-07	64
38-745-02-07	64
38-750-16-07	65
38-751-01-07	65
38-751-02-07	65
38-751-03-07	65
38-780-00-07	66

38-780-01-07	66
38-781-00-07	66
38-781-01-07	66
38-783-01-07	66
38-786-04-07	66
38-786-06-07	66
38-786-08-07	66
38-786-10-07	66
38-786-12-07	66
38-786-14-07	66
38-786-16-07	66
38-790-04-07	67
38-790-06-07	67
38-790-08-07	67
38-791-01-07	67
38-791-03-07	67
38-796-04-07	67
38-796-06-07	67
38-796-08-07	67
38-797-04-07	68
38-797-06-07	68
38-799-06-07	68
38-799-08-07	68
38-810-00-07	68
38-810-01-07	68
38-810-02-07	68
38-810-03-07	68
38-829-00-07	69
38-831-01-07	69
38-831-02-07	69
38-833-18-07	70
38-835-19-07	70
38-837-01-07	71
38-837-02-07	71
38-837-03-07	71
38-837-04-07	71
38-839-18-07	72
38-841-22-07	72
38-843-19-07	72
38-843-99-07	72
38-845-01-07	73
38-845-02-07	73
38-846-20-07	73
38-850-01-07	74
38-850-02-07	74
38-851-16-07	75
38-853-24-07	75
38-855-17-07	75
38-856-19-07	75
38-870-17-07	76
38-875-18-07	76
38-877-00-07	76
38-878-01-07	77
38-878-02-07	77
38-881-07-07	78
38-881-10-07	78
38-883-07-07	78
38-883-11-07	78
38-883-15-07	78
38-885-18-07	78

38-891-01-07 .....79  
 38-891-02-07 .....79  
 38-893-16-07 .....80  
 38-895-05-07 .....80  
 38-895-08-07 .....80  
 38-899-06-07 .....80  
 38-899-08-07 .....80

**39**

39-100-17-07 .....4

**48**

48-101-16-07 .....81  
 48-101-25-07 .....81  
 48-101-35-07 .....81  
 48-101-42-07 .....81  
 48-101-55-07 .....81  
 48-101-70-07 .....81  
 48-101-80-07 .....81  
 48-103-16-07 .....82  
 48-103-25-07 .....82  
 48-103-35-07 .....82  
 48-103-42-07 .....82  
 48-103-55-07 .....82  
 48-103-70-07 .....82  
 48-103-80-07 .....82  
 48-107-22-07 .....83  
 48-109-22-07 .....83  
 48-111-22-07 .....83  
 48-113-22-07 .....83  
 48-115-01-07 .....84  
 48-115-02-07 .....84  
 48-117-01-07 .....84  
 48-117-02-07 .....84  
 48-121-08-07 .....84  
 48-121-10-07 .....84  
 48-125-15-07 .....84  
 48-130-06-07 .....85  
 48-130-07-07 .....85  
 48-130-09-07 .....85  
 48-130-11-07 .....85  
 48-132-06-07 .....85  
 48-132-07-07 .....85  
 48-132-09-07 .....85  
 48-132-11-07 .....85  
 48-135-21-07 .....86  
 48-137-21-07 .....86  
 48-140-01-07 .....86  
 48-140-02-07 .....86  
 48-150-01-07 .....86  
 48-150-02-07 .....86  
 48-152-05-07 .....87  
 48-152-07-07 .....87  
 48-152-09-07 .....87  
 48-156-04-07 .....87  
 48-156-06-07 .....87  
 48-156-08-07 .....87  
 48-160-08-04 .....88

48-160-12-04 .....88  
 48-160-16-04 .....88  
 48-162-08-04 .....88  
 48-162-12-04 .....88  
 48-162-16-04 .....88  
 48-162-20-04 .....88  
 48-163-01-07 .....89  
 48-163-02-07 .....89  
 48-164-15-07 .....90  
 48-164-20-07 .....90  
 48-166-08-07 .....91  
 48-166-11-07 .....91  
 48-167-08-07 .....91  
 48-167-11-07 .....91  
 48-168-03-07 .....91  
 48-168-04-07 .....91  
 48-168-06-07 .....91  
 48-170-23-07 .....91  
 48-175-15-07 .....92  
 48-175-17-07 .....92  
 48-177-24-07 .....92  
 48-190-11-07 .....93  
 48-192-01-07 .....93  
 48-192-02-07 .....93  
 48-192-03-07 .....93  
 48-194-13-07 .....93  
 48-196-14-07 .....93  
 48-198-14-07 .....93  
 48-220-01-07 .....94  
 48-220-02-07 .....94  
 48-250-19-07 .....95  
 48-252-13-07 .....95  
 48-261-30-07 .....96  
 48-261-45-07 .....96  
 48-261-70-07 .....96  
 48-270-02-07 .....97  
 48-270-03-07 .....97  
 48-270-05-07 .....97  
 48-270-07-07 .....97  
 48-270-10-07 .....97  
 48-270-14-07 .....97  
 48-270-16-07 .....97  
 48-271-05-07 .....97  
 48-271-07-07 .....97  
 48-271-10-07 .....97  
 48-272-18-07 .....97  
 48-273-10-07 .....97  
 48-274-10-07 .....98  
 48-274-15-07 .....98  
 48-274-20-07 .....98  
 48-274-30-07 .....98  
 48-275-10-07 .....98  
 48-275-15-07 .....98  
 48-276-10-07 .....98  
 48-276-15-07 .....98  
 48-277-10-07 .....98  
 48-277-15-07 .....98  
 48-285-20-07 .....99  
 48-285-28-07 .....99  
 48-287-01-07 .....100

48-287-02-07 .....100  
 48-287-03-07 .....100  
 48-287-04-07 .....100  
 48-291-15-07 .....101  
 48-293-19-07 .....101  
 48-300-20-07 .....101  
 48-301-21-07 .....101  
 48-303-22-07 .....101  
 48-311-01-07 .....102  
 48-311-02-07 .....102  
 48-313-01-07 .....102  
 48-313-02-07 .....102  
 48-316-21-07 .....102  
 48-318-16-07 .....102  
 48-320-14-07 .....102  
 48-330-01-07 .....103  
 48-330-02-07 .....103  
 48-330-03-07 .....103  
 48-331-01-07 .....104  
 48-331-02-07 .....104  
 48-331-03-07 .....104  
 48-331-04-07 .....104  
 48-331-05-07 .....104  
 48-333-03-07 .....105  
 48-333-04-07 .....105  
 48-333-05-07 .....105  
 48-335-01-07 .....106  
 48-335-02-07 .....106  
 48-335-03-07 .....106  
 48-335-04-07 .....106  
 48-335-05-07 .....106  
 48-335-06-07 .....106  
 48-340-18-07 .....107  
 48-341-18-07 .....107  
 48-345-18-07 .....107  
 48-350-24-07 .....107  
 48-351-13-07 .....108  
 48-352-14-07 .....108  
 48-354-16-07 .....108  
 48-356-16-07 .....108  
 48-360-01-07 .....109  
 48-360-02-07 .....109  
 48-362-01-07 .....109  
 48-362-02-07 .....109  
 48-370-26-07 .....110  
 48-371-18-07 .....110  
 48-376-18-07 .....110  
 48-380-01-07 .....111  
 48-380-02-07 .....111  
 48-400-07-07 .....111  
 48-400-12-07 .....111  
 48-402-02-07 .....111  
 48-402-03-07 .....111  
 48-402-05-07 .....111  
 48-405-00-07 .....112  
 48-405-01-07 .....112  
 48-420-00-07 .....112  
 48-500-18-07 .....112  
 48-506-20-07 .....112  
 48-525-23-07 .....113

48-531-19-07 .....113  
 48-541-60-07 .....113  
 48-701-22-07 .....116  
 48-703-19-07 .....116  
 48-704-22-07 .....116  
 48-705-14-07 .....117  
 48-706-18-07 .....117  
 48-707-14-07 .....117  
 48-708-01-07 .....118  
 48-708-14-07 .....118  
 48-709-18-07 .....118  
 48-711-22-07 .....119  
 48-711-23-07 .....119  
 48-711-24-07 .....119  
 48-711-25-07 .....119  
 48-712-12-07 .....119  
 48-714-20-07 .....120  
 48-715-42-07 .....120  
 48-716-22-07 .....120  
 48-716-42-07 .....120  
 48-716-55-07 .....120  
 48-717-42-07 .....121  
 48-723-22-07 .....121  
 48-725-18-07 .....121  
 48-726-08-07 .....122  
 48-726-15-07 .....122  
 48-727-20-07 .....122  
 48-728-18-07 .....122  
 48-728-19-07 .....123  
 48-729-55-07 .....123  
 48-731-14-07 .....123  
 48-731-22-07 .....124  
 48-731-25-07 .....124  
 48-735-19-07 .....124  
 48-738-12-07 .....124  
 48-738-13-07 .....125  
 48-739-18-07 .....125  
 48-740-20-07 .....125  
 48-756-15-07 .....114

**50**

50-242-12-07 .....10  
 50-430-19-07 .....115  
 50-440-04-07 .....115  
 50-440-06-07 .....115  
 50-440-08-07 .....115  
 50-441-06-07 .....115  
 50-446-19-07 .....115  
 50-450-17-07 .....115  
 50-840-00-07 .....126  
 50-841-00-07 .....127  
 50-910-15-07 .....127  
 50-910-20-07 .....127  
 50-915-15-07 .....127  
 50-915-20-07 .....127  
 50-915-27-07 .....127



---

Index, alphabetisch  
Index, alphabetical  
Índice, alfabético  
Index alphabétique  
Índice, alfabético



<b>A</b>		<b>P</b>	
Alveolar-Nerv-Dissektor, Arnett .....	119	Palatumspreizer, Turvey .....	76
Atr.-Kopfhautklemme, Tessier .....	95	Perforator, Tessier .....	102
Atrauma-Muskelklemme, Terry .....	74	Periost-Elevatorium .....	52
Atrauma-Muskelklemme, Terry .....	74	Periost-Elevatorium .....	52
Äußerer Progeniehaken, Lauer .....	47, 49, 50	Periost-Elevator, Arnett .....	124
		Periostraspatorium .....	102
<b>B</b>		Piriformis-Haken .....	72
Beckenkammspatel, Tessier .....	100	Plattenbiegezange, Arnett .....	124
Blattosteotom, Obwegeser .....	88	Plattenbiegezange, LF1, Arnett .....	125
Bruststütze z. Mundsperrerr .....	20	Plattenhalteklemme, Arnett .....	125
BSSO/LF1-Nerv-Dissektor, Arnett .....	119	Plattenloch-Haken, Eckelt .....	58
BSSO-Lingual-Re retraktor, Arnett .....	116	Progeniehaken, Metz .....	45
BSSO-Split-Osteotom, Arnett .....	122, 123	Progeniehaken, Schuchardt .....	45
BSSO-TMJ-Platzierer, Arnett .....	117	Progenierinne, Obwegeser .....	44, 84
BSSO-Transoral-Re retraktor, Arnett .....	123	Progenierinne, Steinhäuser .....	76
		Pterygoid-Osteotom, Hargis .....	72
<b>C</b>		Pterygoid-Osteotom, Arnett .....	122
Centre Drive®, Aufsatz Dental-Ansatz .....	127		
Cross-Drive Bit, für ASD .....	127	<b>R</b>	
		Rahmen zum Mundsperrerr .....	22
<b>D</b>		Ramus-Krallenhaken, Lindorf .....	40, 41
Dolwick-TMJ-Klemme .....	64	Ramushaken, Hargis .....	69
Drahtbogen, Erich, Meterware .....	53	Ramushaken, Obwegeser .....	44, 83
Drahteinführinstrument, Terry .....	75	Ramushaken, Steinberg .....	113
Drahtpositionierer, Rowe .....	53	Ramusklemme, Obwegeser .....	84
Drahtpositionierer .....	53	Ramusklemme, Steinhäuser .....	77
Drahtschere, Tessier .....	108	Ramusosteotom, Steinhäuser .....	78
Drahtzwickzange, Obwegeser .....	93	Ramusraspatorium, Obwegeser .....	87
		Ramusschieber, Terry .....	75
<b>E</b>		Ramusspreizzange, Smith .....	73
Elevator, Arnett .....	116	Ramustripper, Obwegeser .....	86
Elevatorium, Marchac .....	111	Raspatorium, Obwegeser .....	51, 52, 85, 86
Elevatorium, Obwegeser .....	53, 86	Raspatorium, tiefe V-Form .....	52
Elevatorium, Steinberg .....	112, 113	Raspatorium .....	48
Elevatorium, Steinhäuser .....	76	Repositionszange, Rowe .....	56
Elevatorium, Terry .....	16	Repositionszange .....	109
Endo-Condyle Unit .....	11	Repositionsinstrument, Steinhäuser .....	78
Extraoraler Retraktor, Eckelt .....	32	Retraktor, Shea .....	37
Extraoraler Retraktor, Eckelt .....	33	Retraktor für Kinnosteotomie, Arnett .....	121
Extraoraler Retraktor .....	32	Retraktor für Mentalnerv, Arnett .....	120
Extraoraler Retraktor .....	33	Retraktor für Oberlippe, Arnett .....	120
		Retraktor für BSSO-Inzissionsverschluss .....	119
<b>F</b>		Retraktor n. Wolford .....	80
Fassklemme, Hargis .....	72	Retraktor nach Ishi .....	38, 39
Fingerschutz, Langenbeck .....	18		
Flachzange, Obwegeser .....	93	<b>S</b>	
Flachzange, Obwegeser .....	93	Saugraspatorium, Marchac .....	115
Flachzange, Obwegeser .....	93	Schieblehre, Tessier .....	110
Flachzange, Obwegeser .....	93	Septumlevator, Arnett .....	119
Flachzange, Obwegeser .....	93	Septumosteotom, Obwegeser .....	87
Fragmentklemme, Obwegeser .....	89	Septumosteotom, Terry .....	75
Fragmentklemme, Obwegeser .....	89	Septumosteotom, Tessier .....	107
Frontschablone, Marchac, Jugendliche .....	112	Serviettenhalter, Adams .....	18
Frontschablone, Marchac, Kinder .....	112	Side-Step-Haken, Lindorf .....	40, 41
		Spatel, Tessier .....	103
<b>G</b>		Sperrerr-Rahmen .....	21, 23, 24
Gaumen-Osteotom .....	107	Spina-Nasalis-Haken, Obwegeser .....	43, 83
Gaumenplatte für Zahnlose .....	21	Spreizzange, Tessier .....	110
Gelenkrepositionierer .....	52	Stripper, Hargis .....	71
Gelenkrepositionierer .....	52	Stripper, Obwegeser .....	86
Gummipolster, Paar .....	31		
		<b>T</b>	
<b>H</b>		TC-Drahtzwirbelzange, Obwegeser .....	93
Haken, Dingmann-Wilk .....	58	TC-Drahtzwirbelzange .....	93
Hammer, Arnett .....	122	TC-Schere, Tessier .....	108
Hauthäkchen, Tessier .....	95	Thoraxhaken, Tessier .....	99
		Ti-Lindemann-Fräser .....	17
<b>I</b>		TMJ-Disc-Klemme, Dolwick .....	62
Innerer Progeniehaken, Lauer .....	47, 49, 50	TMJ-Disc-Schere, Dolwick .....	62
Interdental-Elevator, Arnett .....	116	TMJ-Elevatorium, Dolw. ....	62
Interdental-Osteotom, Arnett .....	121	TMJ-Klemme, Dolwick .....	64
Intraoral-Re retraktor .....	34, 35, 36	TMJ-Kondylenhaken, Dolwick .....	62
		TMJ-Raspel, Dolwick .....	63
<b>J</b>		TMJ-Spreizer, Mod. Champy .....	65
Jaboma Spalt-Instrumentarium .....	1-4	Transplantatstopfer .....	16
		Trokar, Tessier .....	102
<b>K</b>			
Keilosteotom, Obwegeser .....	88	<b>U</b>	
Kinnhalter, Obwegeser .....	44, 84	Unterkieferhaken, Hargis .....	70
Klemme, Arnett .....	118	Unterkieferre retraktor, Terry .....	75
Knochenformzange, konkav/konvex .....	94	Unterminierschere, Tessier .....	108
Knochenformzange .....	94, 101		
Knochenhaken, Marchac .....	115		
Knochenhaken, Tessier .....	110		
Knochenhalte zange, JVS .....	58		
Knochenhalte zange, JVS .....	58		
Knochenhalte zange, Keen .....	59		
Knochenhalte zange, Salyer .....	60		
Knochenhalte zange, Steinhäuser .....	59		
Knochenhalte zange, Wolford .....	60		
Knochenhalte zange .....	101		
Knochensplitterzange, Tessier .....	101		
Knochenspreizer, Obwegeser .....	90		
Knochenspreizzange, Marchac .....	115		
Koronoid-Re retraktor, Arnett .....	118		
		<b>L</b>	
LF1-Interdental-Re retraktor, Arnett .....	121	LF1-Posterior Retraktor, Arnett .....	118
LF1-Posterior Retraktor, Arnett .....	118	Lindemann-Fräser .....	17
Lindemann-Fräser .....	17	Lindorf-Bohr-/Schraubhilfe .....	128
Lindorf-Bohr-/Schraubhilfe .....	128	Lindorf-Explantationsinstrument .....	127
Lindorf-Explantationsinstrument .....	127	Lippen- und Wangenhalter .....	69
Lippen- und Wangenhalter .....	69	Lippenhalter, Sternberg .....	27
Lippenhalter, Sternberg .....	27	Lippensperrerr, Oringer .....	26
Lippensperrerr, Oringer .....	26		
		<b>M</b>	
Mandibula-Ahle, Obwegeser .....	92	Mandibular-Re retraktor, Arnett .....	117
Mandibular-Re retraktor, Arnett .....	117	Maxilla-Mobilisator .....	91
Maxilla-Mobilisator .....	91	Maxilläre Sinus-Kürette, Arnett .....	117
Maxilläre Sinus-Kürette, Arnett .....	117	Meißel, Steinhäuser .....	78
Meißel, Steinhäuser .....	78	Messlehre, Marchac .....	112
Messlehre, Marchac .....	112	Messschieber, Arnett .....	123
Messschieber, Arnett .....	123	Messzirkel .....	14
Messzirkel .....	14	Mobilisationshaken, Tessier .....	111
Mobilisationshaken, Tessier .....	111	Mobilisationshaken, Tessier .....	111
Mobilisationshaken, Tessier .....	111	Mobilisierhaken, Smith .....	73
Mobilisierhaken, Smith .....	73	Mobilisierhaken, Smith .....	73
Mobilisierhaken, Smith .....	73	Mobilisierhaken, Tessier .....	57
Mobilisierhaken, Tessier .....	57	Mobilisierhaken, Tessier .....	57
Mobilisierhaken, Tessier .....	57	Mundkeil, Maunder .....	18
Mundkeil, Maunder .....	18	Mundkeil, McKesson, für Zahnlose .....	18
Mundkeil, McKesson, für Zahnlose .....	18	Mundkeil, McKesson, L, für Erwachsene .....	18
Mundkeil, McKesson, L, für Erwachsene .....	18	Mundkeil, McKesson, S, für Kleinkinder .....	18
Mundkeil, McKesson, S, für Kleinkinder .....	18	Mundkeil, McKesson, S, für Erwachsene .....	18
Mundkeil, McKesson, S, für Erwachsene .....	18	Mundkeil, Pitha .....	18
Mundkeil, Pitha .....	18	Mundspatel, Kunststoff .....	29
Mundspatel, Kunststoff .....	29	Mundsperrerr, Davis-Boyle .....	23
Mundsperrerr, Davis-Boyle .....	23	Mundsperrerr, Denhart .....	19
Mundsperrerr, Denhart .....	19	Mundsperrerr, Dingmann .....	25
Mundsperrerr, Dingmann .....	25	Mundsperrerr, Heister .....	19
Mundsperrerr, Heister .....	19	Mundsperrerr, Jennings .....	26
Mundsperrerr, Jennings .....	26	Mundsperrerr, Mclvor .....	24
Mundsperrerr, Mclvor .....	24	Mundsperrerr, Molt, für Erwachsene .....	19
Mundsperrerr, Molt, für Erwachsene .....	19	Mundsperrerr, Molt, für Kinder .....	19
Mundsperrerr, Molt, für Kinder .....	19	Mundsperrerr, Neukam .....	22
Mundsperrerr, Neukam .....	22	Mundsperrerr, Roser-König .....	19
Mundsperrerr, Roser-König .....	19	Mundsperrerr Kilner-Doughty kompl. ....	20, 21
Mundsperrerr Kilner-Doughty kompl. ....	20, 21	Mundsperrerr mit Gelenk, Davis-Boyle .....	23
Mundsperrerr mit Gelenk, Davis-Boyle .....	23		
		<b>N</b>	
Nasa-Mucosa-Haken, Arnett .....	125	Nasa-Mucosa-Haken, Arnett .....	125
Nasenahe, Tessier .....	102	Nasenspekulum, Tessier .....	96
Nasenspekulum, Tessier .....	96	Nasenspekulum, Tessier .....	96
Nasenspekulum, Tessier .....	96	Nasenspekulum, Tessier .....	96
Nasenspekulum, Tessier .....	96		
		<b>O</b>	
Orbita-Elevatorium .....	80	Orbita-Elevatorium .....	80
Orbitahaken, Rowe .....	54	Orbitahaken, Rowe .....	54
Orbitaosteotom, Steinhäuser .....	80	Orbitaosteotom, Steinhäuser .....	80
Orbitaosteotom, Steinhäuser .....	80	Orbitarand-Re retraktor, Donovan .....	54
Orbitarand-Re retraktor, Donovan .....	54	Orbitarand-Re retraktor .....	54
Orbitarand-Re retraktor .....	54	Osteotom, Bauer .....	66
Osteotom, Bauer .....	66	Osteotom, Dunn-Dautrey .....	67
Osteotom, Dunn-Dautrey .....	67	Osteotom, elastisch .....	91
Osteotom, elastisch .....	91	Osteotom, Epker-Bauer .....	66
Osteotom, Epker-Bauer .....	66	Osteotom, Epker .....	67, 68
Osteotom, Epker .....	67, 68	Osteotom, Marchac .....	115
Osteotom, Marchac .....	115	Osteotom, Munro-Dautrey .....	66
Osteotom, Munro-Dautrey .....	66	Osteotom, Obwegeser .....	91
Osteotom, Obwegeser .....	91	Osteotom, Tessier .....	97, 98, 107
Osteotom, Tessier .....	97, 98, 107	Osteotom, Wolford .....	80
Osteotom, Wolford .....	80		

**V**

Vestibulumhaken .....	27
Vorderrandstripper, Hargis .....	70

**W**

Wangen-/Lippenhalter, Bishop .....	27
Wangen-Lippen-Haken, Arnett .....	120
Wangenhalter, Cawood-Minnesota .....	27
Wangenhalter, Martin-Simplex .....	27
Wangenhalter, Obwegeser, Draht .....	27
Wangenknochen-Haken, Arnett .....	120
Weichteilhaken, Tessier.....	104, 105, 106
Weichteilhaken .....	43, 81, 82
Weisheitszahn-Haken, Obwegeser.....	83
Wundhaken, Koberg.....	46

**Z**

Zungendrucker, Hartmann.....	28
Zungendrucker, Tobold .....	28
Zungendrucker, Wieder.....	28
Zungendrucker .....	21, 22
Zungenspatel, Brünings .....	29
Zungenspatel, Doyen .....	29
Zungenspatel, Doyen .....	29
Zungenspatel, Holz .....	29
Zungenspatel .....	23, 24, 25
Zungenzange, Collin.....	31
Zungenzange, Young.....	31
Zygoma-Ahle, Obwegeser.....	92
Zygoma-Elevatorium, Dingmann.....	57
Zygoma-Elevatorium, Gillies .....	57
Zygoma-Haken, Steinhäuser .....	79

- A**  
Alveolar Nerv Dissector, Arnett .....119  
Alveolar Retractor .....83  
Anterior Border Stripper, Hargis .....70  
Archbar, Erich .....53  
Atraumatic Scalp Forceps, Tessier.....95  
Atraumatic Muscle Forceps, Terry .....74
- B**  
Blade Osteotome, Obwegeser.....88  
Bone Contouring Forceps, flat .....94  
Bone Cutting Forceps, Tessier.....101  
Bone Expander, Marchac .....115  
Bone Holding Forceps, Tessier .....101  
Bone Holding Forceps, Steinhäuser.....59  
Bone Hold. Forceps, Tessier.....101  
Bone Holding Forceps, Jvs .....58  
Bone Holding Forceps, Keen .....59  
Bone Holding Forceps, Salyer .....60  
Bone Holding Forceps, Wolford .....60  
Bone Hook, Marchac .....115  
Bone Hook, Tessier, Angled.....110  
Bone Separator, Obwegeser .....90  
Bone Shaping Forceps .....101  
BSSO/LF1 Nerve Dissector, Arnett.....119  
BSSO Condylar Seating Instrument, Arnett.....117  
BSSO Lingual Retractor, Arnett.....116  
BSSO Splitting Osteotome, Arnett .....122  
BSSO Transoral Retractor, Arnett .....123
- C**  
Calipers .....4  
Caliper, Arnett .....123  
Caliper, Marchac.....112  
Caliper, Tessier .....110  
Centre Drive® Blade, Dental Attachment .....128  
Cross-Drive Blade, Dental Attachment.....128  
Channel Retractor, Obwegeser .....44, 84  
Channel Retractor, Steinhäuser.....76  
Channel Retractor, Terry .....75  
Cheek-Lip Retractor, Arnett .....120  
Cheek/Lip Retractor, Bishop.....27  
Cheek Bone Retractor, Arnett .....120  
Cheek Retractor, Cawood-Minnesota.....27  
Cheek Retractor, Martin-Simplex.....27  
Cheek Retractor, Obwegeser .....27  
Chest Support for Mouth Gag .....20  
Chin Osteotomy Retractor, Arnett .....121  
Chin Retractor, Obwegeser .....44, 84  
Chisel, Steinhäuser .....78  
Cleft Plate for Teethless.....21  
Condylar Repositioner .....52  
Contoured Forceps, concave/convex .....94  
Contoured Forceps, convex/concave .....94  
Coronoid Retractor, Arnett.....118  
Coronoid Retractor, Hargis, with Chain .....72  
Cross-Drive Bit, for ASD.....127
- E**  
Elevator, Marchac .....111  
Elevator, Obwegeser .....53, 86  
Elevator, Steinberg, atraumatc .....113  
Elevator, Steinberg.....112, 113  
Elevator, Steinhäuser .....76  
Elevator, Terry .....16  
Elevator, Terry.....16  
Endo-Condyle Unit .....11  
Extraoral Retractor .....33  
Extraoral Retractor, Eckelt.....32  
Extraoral Retractor .....32
- F**  
Finger Protector, Langenbeck .....18  
Flat Nose Pliers, Obwegeser .....93  
Forceps, Arnett.....118  
Fragment Forceps, Obwegeser .....89  
Fragment Forceps, Obwegeser .....89  
Frame only .....21, 22, 23, 24  
Front Template, Marchac, Adolescent .....112  
Front Template, Marchac, Child .....112
- G**  
Graft Packer, Terry .....16
- H**  
Hook, Dingmann-Wilk, sharp .....58
- I**  
Iliac Crest Retractor, Tessier.....100  
Inner Progeny Retractor, Lauer .....47, 49, 50  
Interdental Osteotome, Arnett .....121  
Intraoral Retractor .....34, 35, 36
- J**  
Jaboma Cleft Palate Set .....1-4
- L**  
LF1 Interdental Osteotomy Retractor, Arnett.....121  
LF1 Plate Bending Forceps, Arnett .....125  
LF1 Posterior Retractor, Arnett .....118  
LF1 Interdental Elevator, Arnett .....116  
Lindemann, Burr .....17  
Lindorf Drilling/Screwing Aid.....128  
Lindorf Explantation Instrument.....127  
Lindorf Ramus Claw Retractor .....40, 41  
Lindorf Side Step Retractor.....40  
Lindorf Side Step Retractor.....41  
Lip and Cheek Retractor, Hargis .....69  
Lip Retractor, Oringer.....26  
Lip Retractor, Sternberg.....27
- M**  
Mallet, Arnett .....122  
Mandibular Retractor, Hargis .....70  
Mandibular Awl, Obwegeser .....92  
Mandibular Body Retractor, Arnett .....117  
Maxillary Mobilizer .....91  
Maxillary Mobilizer, Tessier.....57  
Maxillary Sinus Curette, Arnett .....117  
Mental Nerve Retractor .....120  
Midline Flap Retractor, Arnett.....124  
Mobilization Lever, Tessier .....111  
Mouth Gag, Davis Boyle.....23  
Mouth Gag, Denhart.....19  
Mouth Gag, Dingmann .....25  
Mouth Gag, Heister .....19  
Mouth Gag, Jennings.....26  
Mouth Gag, Kilner-Doughty .....20, 21  
Mouth Gag, Mclvor.....24  
Mouth Gag, Molt, for Adults .....19  
Mouth Gag, Molt, for Children .....19  
Mouth Gag, Neukam .....22  
Mouth Gag, Roser-Koenig.....19  
Mouth Gag, with Joint, Davis-Boyle.....23  
Mouth Prop, McKesson, for Adults.....18  
Mouth Prop, McKesson, for Children.....18  
Mouth Prop, McKesson, for Infants.....18  
Mouth Prop, McKesson, for Teehtless.....18  
Mouth Wedge, Pitha.....18
- N**  
Napkin Holder, Adams .....18  
Nasal Awl, Tessier .....102  
Nasal Mucosa Retractor, Arnett .....125  
Nasal Speculum, Tessier .....96
- O**  
Oral Screw, Maunder, Wood, conic .....18  
Orbita Elevator .....80  
Orbital Osteotome, Steinhäuser .....80  
Orbital Retractor, Rowe .....54  
Orbital Rim Retractor, Donovan .....54  
Orbital Rim Retractor .....54  
Osteotome, Bauer .....66  
Osteotome, Dunn-Dautrey.....67  
Osteotome, elastic .....91  
Osteotome, Epker-Bauer.....66  
Osteotome, Epker .....67, 68  
Osteotome, Marchac .....115  
Osteotome, Munro-Dautrey .....66, 67  
Osteotome, Obwegeser .....91  
Osteotome, Tessier .....107  
Osteotome, Tessier.....97, 98  
Osteotome, Wolford.....80  
Outer Progeny Retractor, Lauer .....47, 49, 50
- P**  
Palatal Expander, Turvey .....76  
Palatal Osteotome .....107  
Perforator, Tessier.....102  
Periosteal Elevator, Arnett .....124  
Periosteal Elevator, Arnett .....124  
Periosteal Elevator .....52  
Periosteal Elevator .....52  
Piriform Rim Retractor, Hargis.....72  
Plate Bending Forceps, Arnett, short .....124  
Plate Carrier, Arnett .....125  
Plate Holding Instrument, Eckelt .....58  
Progeny Retractor, Metz .....45  
Progeny Retractor, Schuchardt .....45  
Pterygoid Osteotome, Hargis .....72  
Pterygoid Osteotome, Arnett .....122
- R**  
Ramus Elevator, Arnett.....116  
Ramus Forceps, Obwegeser .....84  
Ramus Forceps, Steinhäuser.....77  
Ramus Osteotome, Steinhäuser .....7878  
Ramus Stripper, Terry.....75  
Ramus Raspatory, Obwegeser .....87  
Ramus Retractor, Hargis .....69  
Ramus Retractor, Obwegeser .....44, 83  
Ramus Separator, Smith.....73  
Ramus Set, Steinberg.....113  
Ramus Stripper, Obwegeser .....86  
Raspatory .....48  
Raspatory, deep v-shape .....52  
Raspatory, Obwegeser, v-shape.....52  
Raspatory, Obwegeser .....51, 85, 86  
Raspatory, Tessier.....102  
Reposition Forceps, Adult, .....109  
Reposition Forceps, Child, .....109  
Reposition Forceps, Rowe .....56  
Reposition Forceps, Steinhäuser .....78  
Retractor, Ishi .....38, 39  
Retractor, Koberg.....46  
Retractor, Obwegeser.....81, 82  
Retractor, Shea .....37  
Retractor, Wolford .....80  
Retractor for BSSO Incision Closure, Arnett.....119  
Rubber Inserts, Pair .....31
- S**  
Separator, Smith .....73  
Septum Elevator, Arnett .....119  
Septum Osteotome, Obwegeser .....87  
Septum Osteotome, Terry.....75  
Septum Osteotome, Tessier.....107  
Skin Hook, Tessier.....95  
Soft Tissue Retractor, Tessier .....104, 105, 106  
Soft Tissue Retractor .....43  
Spatula, Tessier, malleable.....103  
Spatula, Tessier .....103  
Spina Nasalis Retractor, Obwegeser .....43  
Spina Nasalis Retractor, Obwegeser .....83  
Spreading Forceps, Tessier .....110  
Stripper, Hargis.....71  
Stripper, Hargis.....71  
Stripper, Hargis.....71  
Stripper, Hargis.....71  
Stripper, Obwegeser .....86  
Stripper, Obwegeser .....86  
Suction Dissector, Marchac.....115
- T**  
TC-Scissors, Tessier .....108  
TC-Wire Twisting Forceps, Obwegeser .....93  
TC-Wire Twisting Forceps, wide .....93  
Thoracic Retractor, Tessier .....99  
Thorax Retractor, Tessier .....99  
Ti-Lindemann, Burr .....17  
Ti-Lindemann, Burr .....17  
Ti-Lindemann, Burr .....17  
TMJ Condyle Retractor, Dolwick .....62  
TMJ Disc Forceps, Dolwick .....62  
TMJ Disc Scissors, Dolwick .....62  
TMJ Elevator, Dolwick .....62  
TMJ Forceps, Dolwick .....64  
TMJ Rasp, Dolwick, .....63  
TMJ Rasp, Dolwick, hollow .....63



TMJ Spreader, Champy-Type .....	65
TMK Forceps, Dolwick.....	64
Tongue Depressor, Bruenings .....	29
Tongue Depressor, Bruenings .....	31
Tongue Depressor, Doyen .....	29
Tongue Depressor, Doyen .....	29
Tongue Depressor, Hartmann.....	28
Tongue Depressor, Plastic .....	29
Tongue Depressor, Tobold.....	28
Tongue Depressor, Wieder .....	28
Tongue Depressor, Wood .....	29
Tongue Depressor .....	21, 22, 23, 24, 25
Tongue Holding Forceps, Young .....	31
Trocar, Tessier, .....	102

**U**

Undermining Scissors, Tessier.....	108
Upper Lip Retractor, Arnett .....	120

**V**

Vestibulum Retractor .....	27
----------------------------	----

**W**

Wedge Osteotome, Obwegeser .....	88
Wire Cutter, Tessier .....	108
Wire Introducer, Terry .....	75
Wire Nipper, Obwegeser .....	93
Wire Pusher, double-ended .....	53
Wire Pusher, Rowe .....	53

**Z**

ZMJ Rasp, Dolwick, flat .....	63
Zygoma Elevator, Dingmann.....	57
Zygoma Elevator, Gillies.....	57
Zygoma Retractor, Steinhäuser .....	79
Zygoma Retractor, Steinhäuser .....	79
Zygomatic Awl, Obwegeser.....	92

<b>A</b>			
Adams, Porta-servilleta .....	18		
Arnett, Calibre .....	123		
Arnett Martillo .....	122		
Asc. Ramus Elevador, Arnett .....	116		
At-Terry, Pinza Muscular, derecha .....	74		
At-Terry, Pinza Muscular, izquierda .....	74		
<b>B</b>			
Bajalengua .....	21, 22, 25		
Bastidor solo .....	24		
Bastidor suelto .....	21, 22		
Bastidor suelto solo .....	23		
Bauer, Osteótomo, recto .....	66		
Bauer, Osteótomo .....	66		
Bishop, Separador para Labios y Mejilla .....	27		
Bocas de Goma, Par .....	31		
Bruenings, Espátula Lingual, Fenest .....	29		
<b>C</b>			
Cawood-Minnesota, Separador, fenestrado .....	27		
Cawood-Minnesota, Separador .....	27		
Champy, Separador para Atm .....	65		
Cheek Bone Retractor, Arnett .....	120		
Chin Osteotomy Retractor, Arnett .....	121		
Collin, Pinza Tira-Lengua, fenest .....	31		
Compases .....	4		
Coronoid Retractor, Arnett .....	118		
Centre Drive® Punta .....	127		
Cross-Drive Punta .....	127		
<b>D</b>			
Dautrey-Munro, Osteótomo .....	66		
Davis-Boyle, Abre bocas .....	23		
Davis-Boyle Bajalengua .....	23		
Denhart, Abre bocas .....	19		
Dingmann, Elevador Cigomático .....	57		
Dingmann-Wilk, Gancho, agudo .....	58		
Dingmann Abre boca completo .....	25		
Disecador para nervio alveolar OSB .....	119		
Dolwick, Disecador, curvo fuerte .....	63		
Dolwick, Disecador, hueco .....	63		
Dolwick, Disecador, plana .....	63		
Dolwick, Elevador Atm .....	62		
Dolwick, Gancho para Condilo Atm .....	62		
Dolwick, Pinza Atm, grande .....	64		
Dolwick, Pinza Atm, pequeña .....	64		
Dolwick, Pinza Atm .....	62		
Dolwick, Tijera Atm .....	62		
Donovan, Separador Borde Orbital .....	54		
Doyen, Bajalengua .....	29		
Dunn-Dautrey, Osteótomo .....	67		
<b>E</b>			
Eckelt, Gancho para sujetar Placas .....	58		
Eckelt, Separador extraoral .....	32, 33		
Empujador de Alambre, doble .....	53		
Endo-Condyle Unit .....	11		
Epker, Osteótomo .....	67, 68		
Epker-Bauer, Osteótomo .....	66		
Erich, Arco de Alambre, Metro .....	53		
Espátula Lingual, Madera .....	29		
Espátula Lingual, Plástico .....	29		
<b>F</b>			
Forceps, Arnett .....	118		
<b>G</b>			
Gillies, Elevador Cigomático, angul. ....	57		
<b>H</b>			
Hargis, Eucleador .....	71		
Hargis, Gancho Mandibular .....	70		
Hargis, Gancho para Ramo, derecha .....	69		
Hargis, Gancho para Ramo, izquierda .....	69		
Hargis, Gancho Piriforme .....	72		
Hargis, Osteótomo Pterigoideo .....	72		
Hargis, Pinza para Coger, C/Cadena .....	72		
Hargis, Separador Borde Anterior .....	70		
Hargis, Separador para Mejillas .....	69		
Hartmann, Bajalengua .....	28		
Heister, Abre boca .....	19		
<b>I</b>			
Instrumento para Reponer Condilos .....	52		
<b>J</b>			
Jaboma Instrumental para operaciones del paladar .....	1-4		
Jennings, Abre boca .....	26		
Jvs Pinza para Huesos, fuerte .....	58		
Jvs Pinza para Huesos, ligera .....	58		
<b>K</b>			
Keen, Pinza para Huesos .....	59		
Keen, Pinza para Huesos .....	59		
Kilner-Doughty, Abre boca .....	20, 21		
Koberg, Separador .....	46		
Koberg, Separador .....	46		
<b>L</b>			
Langenbeck, Dedal .....	18		
Lauer, Separador Mandibular .....	47		
Lauer, Separador Mandibular .....	47		
Lauer, Separador Mandibular .....	49		
Lauer, Separador Mandibular .....	50		
Lauer, Separador Mandibular .....	50		
Legra, Punta De Trabajo .....	48		
Legra .....	48		
LF1 Alicata para doblar Placas, Arnett .....	125		
LF1 Osteótomo interdental, Arnett .....	121		
LF1 Retractor interdental, Arnett .....	116		
LF1 Retractor posterior, Arnett .....	118		
Lindemann, Fresa .....	17		
Lindorf, Ayuda para Perforar/Atornillar .....	128		
Lindorf, Instrumento para Explantación .....	127		
Lindorf, Separador Garra Rama .....	40, 41		
Lindorf, Separador Side Step .....	40, 41		
<b>M</b>			
Marchac, Calibre .....	112		
Marchac, Disecador, recto .....	115		
Marchac, Osteótomo .....	115		
Marchac, Periostótomo .....	111		
Marchac, Pinza para Separar Huesos .....	115		
Marchac, Plantilla Frontal, Adultos .....	112		
Marchac, Plantilla Frontal, Niños .....	112		
Marchac Ganchito, agudo .....	115		
Martin-Simplex, Separador de Mejilla .....	27		
Maunder, Cuna Abre boca, Madera .....	18		
Mclvor, Abre boca completo .....	24		
Mclvor Bajalengua .....	24		
McKesson, Garrote, para Adultos .....	18		
McKesson, Garrote, para Adultos .....	18		
McKesson, Garrote, para Bebes .....	18		
McKesson, Garrote, para Desdentados .....	18		
McKesson, Garrote, para Niños .....	18		
Metz, Separador Mandibular .....	45		
Molt, Abre-Boca, para Ninos .....	19		
Molt, Abre boca, para Adultos .....	19		
<b>N</b>			
Neukam Abre boca Completo .....	22		
<b>O</b>			
Obwegeser, Alicates .....	93		
Obwegeser, Elevador, doble .....	53		
Obwegeser, Elevador .....	86		
Obwegeser, Gancho de Menton .....	44, 84		
Obwegeser, Legra, redonda .....	85		
Obwegeser, Legra .....	85		
Obwegeser, Lezna Cigomática .....	92		
Obwegeser, Lezna Mandibular .....	92		
Obwegeser, Movilizador Maxilar .....	91		
Obwegeser, Osteótomo, Flex .....	91		
Obwegeser, Osteótomo .....	91		
Obwegeser, Periostótomo .....	51, 52, 86, 87, 88		
Obwegeser, Pinza p. Fragmentos, derecha .....	89		
Obwegeser, Pinza p. Fragmentos, izquierda .....	89		
Obwegeser, Pinza Ramo, largo, derecha .....	84		
Obwegeser, Pinza Ramo, largo, izquierda .....	84		
Obwegeser, Pinza Ramo, pequeña, derecha .....	84		
Obwegeser, Pinza Ramo, pequeña, izquierda .....	84		
Obwegeser, Retractor Mandib .....	84		
Obwegeser, Separador .....	43, 81, 82, 83		
Obwegeser, Separador Alveolar .....	83		
Obwegeser, Separador De Mejilla, Alambre .....	27		
Obwegeser, Separador Mandibular .....	44		
Obwegeser, Separador para Ramo .....	44		
Obwegeser, Separador Spina Nasalis .....	43, 83		
Oringer, Separador para Labios, Juego .....	26		
Oringer, Separador para Labios .....	26		
Osteótomo de Paladar .....	107		
Osteótomo interdental, Arnett .....	121		
Osteótomo pterigoideo, Arnett .....	121		
<b>P</b>			
Periostótomo, fuertemente .....	52		
Periostótomo, ligeramente .....	52		
Periostótomo .....	52		
Pinza para Formar Huesos, concavo/concavo .....	94		
Pinza para Formar Huesos, convexo/concavo .....	94		
Pinza para Formar Huesos, plana .....	94		
Pitha, Garrote, con Cadena .....	18		
<b>R</b>			
Retractor para mejillas y labios, Arnett .....	120		
Retractor para Labio superior, Arnett .....	120		
Roser-König, Abre boca .....	19		
Rowe, Empujador de Alambre .....	53		
Rowe, Gancho Orbital, derecho .....	54		
Rowe, Gancho Orbital, izquierdo .....	54		
Rowe, Pinza Reposición, derecha .....	56		
Rowe, Pinza Reposición, izquierda .....	56		
<b>S</b>			
Salyer, Pinza para Huesos .....	60		
Schuchardt, Separador Mandibular .....	45		
Separador Extraoral .....	32, 33, 34, 35, 36		
Separador Intraoral, Ishi .....	38, 39		
Separador Mandíbula, Lauer .....	49		
Separador para Borde Orbital .....	54		
Separador para Hueso, Obwegeser .....	90		
Separador para Vestíbulo .....	27		
Septum Elevator, Arnett .....	119		
Shea, Sepador .....	37		
Smith, Gancho Mobilizador, derecho .....	73		
Smith, Gancho Mobilizador, izquierda .....	73		
Smith, Separador De Ramo .....	73		
Soporte de Paladar .....	21		
Steinberg, Periostótomo .....	112, 113		
Steinberg, Separador Ramo .....	113		
Steinhäuser, Pinza para Huesos .....	59		
Steinhäuser, Cincel .....	78		
Steinhäuser, Elevador .....	76		
Steinhäuser, Elevador Orbital .....	80		
Steinhäuser, Gancho Mandibular .....	76		
Steinhäuser, Instrumento de Reposición .....	78		
Steinhäuser, Osteótomo .....	78		
Steinhäuser, Osteótomo Orbital .....	80		
Steinhäuser, Osteótomo Orbital .....	80		
Steinhäuser, Pinza para Ramo, derecha .....	77		
Steinhäuser, Pinza para Ramo, izquierda .....	77		
Steinhäuser, Separador Cigoma, derecha .....	79		
Steinhäuser, Separador Cigoma, izquierda .....	79		
Sternberg, Separador para Labios .....	27		
<b>T</b>			
TC-Obwegeser, Pinza Torce-Hilos .....	93		
TC-Tessier, Tijera, aguda, recta .....	108		
TC-Tessier, Tijera, roma, recta .....	108		
Terry, Corredera De Rama .....	75		
Terry, Elevador .....	16		
Terry, Elevador .....	16		
Terry, Elevador .....	16		
Terry, Elevador .....	16		
Terry, Gancho Mandibular .....	75		
Terry, Introductor De Alambre .....	75		
Terry, Osteótomo para Septum .....	75		
Tessier, Calibre, angulado .....	110		
Tessier, Cizalla para Huesos .....	101		
Tessier, Cizalla para Huesos .....	101		
Tessier, Erina, aguda .....	95		
Tessier, Espátula Maleable .....	103		
Tessier, Espéculo Nasal .....	96		
Tessier, Gancho Cresta Iliaca .....	100		
Tessier, Gancho Cresta Iliaca .....	100		
Tessier, Gancho De Movilizacion, derecha .....	111		

Tessier, Gancho De Movilizacion, izquierda .....111  
 Tessier, Gancho Movilizacion, Derecho.....57  
 Tessier, Gancho Movilizacion, izquierdo.....57  
 Tessier, Gancho para Huesos, angul.....110  
 Tessier, Gancho Tórax.....99  
 Tessier, Legra .....102  
 Tessier, Legra .....102  
 Tessier, Lezna Nasal .....102  
 Tessier, Osteótomo, recto.....97, 98  
 Tessier, Osteótomo.....97, 98, 107  
 Tessier, Osteótomo Nasal, recto .....107  
 Tessier, Periostótomo.....102  
 Tessier, Periostótomo.....102  
 Tessier, Pinza de Expansión, .....110  
 Tessier, Pinza para Cabelludo.....95  
 Tessier, Pinza para Formar Huesos.....101  
 Tessier, Pinza para Huesos.....101  
 Tessier, Pinza para Huesos.....101  
 Tessier, Pinza Reposición, derecha, Adultos .....109  
 Tessier, Pinza Reposición, derecha, Niños.....109  
 Tessier, Pinza Reposición, izquierdo, Adultos ...109  
 Tessier, Pinza Reposición, izquierdo, Niños .....109  
 Tessier, Punzón.....102  
 Tessier, Separador .....104, 105, 106  
 Tessier, Tijera de Disecc.....108  
 Tessier, Tijera para Alambre, recta .....108  
 Tessier, Trocar .....102  
 Ti-Lindemann, Fresa .....17  
 Ti-Lindemann, Fresa .....17  
 Ti-Lindemann, Fresa .....17  
 Tobold, Bajalengua .....28  
 Tobold, Bajalengua .....28  
 Turvey, Extensor Palatinal .....76

**U**

Unité endo-condylienne .....127

**W**

Wieder, Bajalengua .....28  
 Wolford, Osteótomo, angulado.....80  
 Wolford, Pinza para Huesos.....60

**Y**

Young, Pinza Tira-Lengua, acodada.....31

<b>A</b>			
Abaisse-Langue pour Ouvre-Bouche, Neukam.....	22		
Abaille-Langue .....	21, 29		
Abaisse-Langues en Bois.....	29		
Adams, Porte-Serviettes.....	18		
Adapt. Emb. Dent.....	128		
Appui-Poitrine pour Ouvre-Bouche .....	20		
<b>B</b>			
Bauer, Ostéotome .....	66		
Bishop, Ecarteur Lèvres/Joues.....	27		
Bruenings, Abaisse-Langue.....	29		
BSSO/LF1 Dissecteur de Nerf, Arnett.....	119		
BSSO Instrument de Positionnement, Arnett.....	117		
BSSO Ostéotome Dédoulement, Arnett.....	122		
BSSO Rétracteur Lingual, Arnett.....	116		
BSSO Rétracteur Transoral, Arnett .....	123		
<b>C</b>			
Calibre Arnett.....	123		
Cawood-Minnesota, Ecarteur .....	27		
Champy, TMJ Rétracteur.....	65		
Compas .....	4		
Collin, Pince Tire-Langue.....	31		
Centre Drive Lames pour Vis .....	127		
Centre Drive Lames pour Vis.....	127		
Cross-Drive Lames pour Vis .....	127		
Curette p. Sinus Maxillaire, Arnett.....	117		
<b>D</b>			
Dautrey-Munro, Ostéotome .....	66		
Davis-Boyle, Abaisse-Langue.....	23		
Davis-Boyle, Manche seul .....	23		
Davis-Boyle, Ouvre-Bouche Jeu.....	23		
Denhart, Ouvre-Bouche .....	19		
Dingman, Abaisse-Langue .....	25		
Dingman, Elévateur Zygomatique.....	57		
Dingman-Wilk, Ecarteur .....	58		
Dolwick, Crochet .....	62		
Dolwick, TMJ Ciseaux.....	62		
Dolwick, TMJ Elévateur .....	62		
Dolwick, TMJ Pince .....	62, 64		
Dolwick, TMJ Rugine-Rasp .....	63		
Doyen, Abaisse-Langue.....	29		
Dunn-Dautrey, Ostéotome .....	67		
<b>E</b>			
Ecarteur à Joue Fenêtre .....	27		
Ecarteur à Progenie .....	44		
Ecarteur à Os d'Obwegeser .....	90		
Ecarteur de Joue d'Obwegeser .....	27		
Ecarteur des Lèvres et Jones, Arnett.....	120		
Ecarteur d'Obwegeser.....	43		
Ecarteur pour le Ramus.....	44		
Ecarteur pour Vestibulum .....	27		
Eckelt, Crochet pour Maintenir Plaque.....	58		
Eckelt, Rétracteur Extra-Oraux .....	32		
Eckelt, Rétracteur Extra-Oraux Lum. Froide.....	33		
Elévateur à Périoste, Arnett .....	124		
Elévateur-Dissec. d'Obwegeser .....	53		
Elévateur pour le Perioste, Fort Courbé.....	52		
Elévateur pour le Perioste, Leger. Courbé.....	52		
Epker, Ostéotome .....	67, 68		
Epker-Bauer, Ostéotome .....	66		
Erich, Arc De Fil (par Mètre) .....	53		
Ecarteur à Progenie.....	44		
Ecarteur pour Spina Nasalis .....	43		
Endo-Condyle Unit .....	11		
<b>H</b>			
Hargis, Crochet p. la Fosse Piriforme .....	72		
Hargis, Ecarteur Machoire Inf.....	70		
Hargis, Ecarteur pour le Bord Antérieur .....	70		
Hargis, Ecarteur pour Lèvres et Joues.....	69		
Hargis, Rugine-Raspatoires.....	71		
Hargis, Ptérygoïde Ostéotome .....	72		
Hargis, Ramus Ecarteur .....	69		
Hargis, Stripper .....	71		
Hartmann, Abaisse-Langue.....	28		
Heister, Ouvre-Bouche.....	19		
<b>I</b>			
Interdental Ostéotome, Arnett .....	121		
<b>J</b>			
Jaboma, set d'instruments pour fente.....	1-4		
Jennings, Ouvre-Bouche .....	26		
Jvs Daviers, Porte-Os.....	58		
<b>K</b>			
Keen Daviers Porte-Os.....	59		
Kilner-Doughty, Ouvre-Bouche .....	20, 21		
Koberg Ecarteurs .....	46		
<b>L</b>			
Langenbeck, Doigtier .....	18		
Lauer, Crochet de Progenie, Ext.....	47, 49, 50		
Lauer, Crochet de Progenie, Int.....	47, 49, 50		
LF1 Rétracteur Interdentaire, Arnett.....	121		
LF1 Rétracteur Postérieur, Arnett .....	118		
LF1 Pince de Pliage, Arnett .....	125		
Lindorf, Aide De Forage/Vissage .....	128		
Lindorf, Instrument D'Explantation .....	127		
Lindorf, Rétracteur .....	40, 41		
<b>M</b>			
Manche pour Ouvre-Bouche, Neukam.....	22		
Marchac, Calibre.....	112		
Marchac, Elévateur .....	111		
Marchac, Gabarit Frontal p. Adultes et Bébés.....	112		
Marchac, Irrigateur .....	115		
Marchac, Ostéotome .....	115		
Marchac, Pince pour Separer OS.....	115		
Maillet, Arnett .....	122		
Maunder, Bâillon.....	18		
Mclvor, Abaisse-Langue.....	24		
Mclvor, Manche à Ouvre-Bouche .....	24		
Mclvor, Ouvre-Bouche Jeu Cpl .....	24		
McKesson, Ouvre-Bouche .....	18		
Mèche, Lindemann .....	17		
Metz, Chrochets de Progenie.....	45		
Mobilisateur de Tessier gaucheche.....	57		
Mobilisateur Obwegeser pour Maxillaire.....	91		
Molt, Ouvre-Bouche Adultes.....	19		
Molt, Ouvre-Bouche, Enfants.....	19		
Mors, Caoutchouc, Young .....	31		
<b>N</b>			
Neukam, Ouvre-Bouche, Complet .....	22		
<b>O</b>			
Obwegeser, Alène .....	92		
Obwegeser, Channel Retractor .....	84		
Obwegeser, Contouring Forceps.....	94		
Obwegeser, Ecarteur .....	81, 82		
Obwegeser, Ecarteur Dent Sagesse.....	83		
Obwegeser, Ecarteur Mandibulaire.....	84		
Obwegeser, Ecarteur Porte-Menton.....	84		
Obwegeser, Ecarteur Spina Nasalis .....	83		
Obwegeser, Elévateur.....	85, 86		
Obwegeser, Ostéotome .....	88, 91		
Obwegeser, Ostéotome p. Cloison Nasale .....	87		
Obwegeser, Pince à Couper le Fil.....	93		
Obwegeser, Pince p. Former OS .....	94		
Obwegeser, Pince à Modeler .....	94		
Obwegeser, Pince à Torsader .....	93		
Obwegeser, Ecarteur p. Ramus .....	83		
Obwegeser, Pincas p. Ramus .....	84		
Obwegeser, Septum Ostéotome .....	87		
Obwegeser, Septum Ostéotome .....	87		
Oringer, Ecart. des Lèvres .....	26		
Ostéotome Palatinal .....	107		
Ostéotome Ptérygoïde, Arnett .....	122		
Outil De Positionnement .....	53		
Ouvre-Bouche avec Articulat. Davis-Boyle .....	23		
Ouvre-Bouche seul.....	21		
Ouvre Bouche Dingmann complet .....	25		
<b>P</b>			
Pince à Fragments D'Obwegeser.....	89		
Pince de Reposition, Rowe .....	56		
Pince de Maintien, Arnett .....	125		
Pincas, Arnett .....	118		
Pitha, Bâillon à Chaîne .....	18		
Plaque Palatine.....	21		
<b>R</b>			
Repositionneur pour Articul. Mahoire .....	52		
Rétracteur.....	32, 33		
Rétracteur Coronioïde, Arnett.....	118		
Rétracteur BSSO p. Fermet. d'Inces, Arnett.....	119		
Rétracteur pour Génioplastie, Arnett .....	121, 124		
Rétracteur pour Mandible, Arnett .....	117		
Rétracteur, Ishi .....	38, 39		
Rétracteur Intra-Oral .....	3, 35		
Rétracteur Intra Oral L&M A.L.F.....	36		
Rétracteur Shea .....	37		
Roser-Koen, Ouvre-Bouche .....	19		
Rowe, Orbit Retractor .....	54		
Rowe, Outil de Positionnement .....	53		
Rugine de Obwegeser .....	51		
Rugine D'Obwegeser.....	52		
Rugines-Raspatoires .....	48		
<b>S</b>			
Salyer, Daviers Porte-Os .....	60		
Schuchardt, Crochets de Progenie .....	45		
Steinhäuser, Ecarteur Cygomatique.....	79		
Simplex, Ecarteur Joues .....	27		
Smith, Ecarteur .....	73		
Smith, Ecarteur .....	73		
Smith, Pincas à Saisir .....	73		
Steinhäuser, Ciseaux-Burins.....	78		
Steinberg, Ecarteur Ped. Ramus .....	113		
Steinberg, Elévateur .....	112, 113		
Steinhäuser, Elévateur .....	76		
Steinhäuser, Daviers Porte-Os .....	59		
Steinhäuser, Orbital Elévateur .....	80		
Steinhäuser, Orbital Ostéotome.....	80		
Steinhäuser, Ostéotome .....	78		
Steinhäuser, Pince de Rép. .....	78		
Sternberg, Ecarteur Lèvres.....	27		
Support-Menton D'Obwegeser .....	44		
<b>T</b>			
Terry, Modif. Ostéotome .....	75		
Terry, Elévateur.....	16		
Terry, Introduceur p. Fil.....	75		
Terry, Manipulateur p. Ramus .....	75		
Terry, Pince-Clamp Musculaire.....	74		
Terry, Pousoires p. Transplant.....	16		
Tessier, Ecarteur p. Parties Molles .....	106		
Terry, Rétracteur.....	75		
Tessier, Alène Nasale .....	102		
Tessier, Calibre .....	110		
Tessier, Ciseaux à Dissection.....	108		
Tessier, Ciseaux pour Fils .....	108		
Tessier, Ciseaux TC .....	108		
Tessier, Ecarteur p. Parties Molles .....	101		
Tessier, Ecarteur.....	110, 111		
Tessier, Ecarteur Chirurgie Thoracique .....	99		
Tessier, Ecarteur p. Parties Molles .....	106		
Tessier, Elévateur.....	102		
Tessier, Erignes Cutanées .....	95		
Tessier, Iliac Crest Rétracteur.....	100		
Tessier, Mod. Kawamoto, Ostéotome.....	107		
Tessier, Ostéotome.....	97, 98		
Tessier, Ostéotome Nasal.....	107		
Tessier, Perforateur.....	102		
Tessier, Periosteal Elévateur .....	102		
Tessier, Pince pour Cuir Chevelu .....	95		
Tessier, Pincas Coupantes Os.....	101		
Tessier, Pincas Coupantes Os.....	101		
Tessier, Rétracteur Malléable.....	103		
Tessier, Rétracteur Parties Molles.....	104, 105		
Tessier, Speculum Nasal .....	96		
Tessier, Trocarts .....	102		
Tessier-Rowe, Pince à Reduc, droit, .....	109		
Tessier-Rowe, Pince à Reduc., gauche .....	109		
Tessier Daviers, Porte-Os .....	101		
Ti-Lindemann, Mèches.....	17		
Tobold, Abaisse-Langue.....	28		
Turvey, Palatum Ecarteur .....	76		
<b>W</b>			
Wieder, Abaisse-Langue.....	28		
Wieder, Abaisse-Langue.....	28		
Wolford, Daviers Porte-Os.....	60		
Wolford, Ostéotome.....	80		
<b>Y</b>			
Young, Pince Tire-Langue.....	31		

<b>A</b>			
Abbassalingua, Davis-Boyle.....	23		
Abbassalingua, Dingmann.....	25		
Abbassalingua, Hartmann.....	28		
Abbassalingua, Kilner-Doughty.....	21		
Abbassalingua, Mclvor.....	24		
Abbassalingua, Neukam.....	22		
Abbassalingua, Tobold.....	28		
Abbassalingua, Wieder.....	28		
Abbassalingua Bruenings.....	29		
Abbassalingua di Legno.....	29		
Abbassalingua Doyen.....	29		
Abbassalingua Plast.....	29		
Alesatore, Lindemann.....	17		
Apribocca, Denhart.....	19		
Apribocca, Dingmann, completo.....	25		
Apribocca, Heister.....	19		
Apribocca, Jennings.....	26		
Apribocca, Maunder.....	18		
Apribocca, McKesson.....	18		
Apribocca, Molt, per Adulti.....	19		
Apribocca, Molt, per Bambini.....	19		
Apribocca, Pitha.....	18		
Apribocca, Roser-Koenig.....	19		
Arco di Filo, Erich.....	53		
Arnett, Calibro.....	123		
Arnett, Curretta.....	116		
Arnett, Curretta Seno Mascel. Anter.....	117		
Arnett, Dissettore Nervo Alveolare.....	119		
Arnett, Dissettore Nervo Inf. BSSO.....	121		
Arnett, Dissettore Nervo Inferiore.....	119		
Arnett, Elevatore Periost.....	124		
Arnett, Elevatore Per Setto Nasale.....	119		
Arnett, Elevatore Ramo Ascendente.....	116		
Arnett, Martello.....	122		
Arnett, Osteotomo BSSO.....	122		
Arnett, Osteotomo Interdentale.....	121		
Arnett, Osteotomo Pterigoideo.....	122		
Arnett, Pinza, Morso.....	118		
Arnett, Pinza Piegaplacche.....	125		
Arnett, Pinza Piegaplacche corta.....	124		
Arnett, Pinza Portaplacche.....	125		
Arnett, Retrattore Coronoido.....	118		
Arnett, Retrattore Lembo Mediano.....	124		
Arnett, Retrattore Linguale.....	116		
Arnett, Retrattore Mandibolare.....	117		
Arnett, Retrattore Mucosa Nasale.....	125		
Arnett, Retrattore Osteot. Sinfisi Mandib.....	121		
Arnett, Retrattore Per Guancia.....	120		
Arnett, Retrattore Post. Le Fort.....	118		
Arnett, Retrattore Transorale BSSO.....	123		
Arnett, Strum. per Condilo Mandibolare.....	117		
<b>C</b>			
Calibro, Marchac.....	112		
Calibro, Tessier.....	110		
Compassi.....	4		
<b>D</b>			
Dissettore ad Aspirazione, Marchac.....	115		
Divaricatore, Cawood-Minnesota.....	27		
Divaricatore, Cawood-Minnesota Fenest.....	27		
Divaricatore, Champy.....	65		
Divaricatore, Donovan.....	54		
Divaricatore, Koberg.....	46		
Divaricatore, Obwegeser.....	81, 82, 83		
Divaricatore, Rowe.....	54		
Divaricatore, Steinberg.....	113		
Divaricatore, Steinhäuser.....	76		
Divaricatore, Sternberg.....	27		
Divaricatore, Tessier.....	104, 105, 106		
Divaricatore Hargis per Mandibola.....	70		
Divaricatore Orbitale.....	54		
Divaricatore per Condilo, Dolwick.....	62		
Divaricatore per Cresta Iliaca, Tessier.....	100		
Divaricatore per Guancia, Martin-Simplex.....	27		
Divaricatore per Labbra, Oringer.....	26		
Divaricatore per Labbra e Guancia, Bishop.....	27		
Divaricatore per Ramo, Hargis.....	69		
Divaricatore per Zigomo, Steinhäuser.....	79		
Divaricatore Toracico, Tessier.....	99		
Divaricatore Toracico, Tessier.....	99		
Divaricatore Zigomo, Dingman-Wilk.....	58		
<b>E</b>			
Elevatore Periost., Tessier.....	102		
Elevatore, Dolwick.....	62		
Elevatore, Hargis.....	71, 72		
Elevatore, Steinberg.....	113		
Elevatore, Steinhäuser.....	76		
Elevatore, Terry.....	16		
Elevatore, Terry Packer.....	16		
Elevatore Doppio, Obwegeser.....	53		
Elevatore Doppio, Steinberg.....	112		
Elevatore Krenkel Leggermente.....	52		
Elevatore per Periostio.....	48		
Elevatore per Ramo, Obwegeser.....	87		
Elevatore Steinhäuser.....	80		
Elevatore Zigomo, Dingman.....	57		
Elevatore Zigomo, Gillies.....	57		
<b>F</b>			
Forbice, Dolwick.....	62		
Forbice, Tessier.....	108		
Forbice per Tunnelare, Tessier.....	108		
Forbici TC, Tessier.....	108		
Forbici TC, Tessier.....	108		
<b>G</b>			
Gancio, Tessier.....	57		
Gancio, Tessier.....	57		
Gancio per Cute, Tessier.....	95		
Gancio per Ossa, Tessier.....	110		
<b>I</b>			
Introduttore per Filo, Terry.....	75		
<b>J</b>			
Jaboma, set di strumenti per cheilo-labbro.....	1-4		
<b>L</b>			
Leva, Tessier.....	111		
Leva, Tessier.....	111		
Lindorf, Aiuto per Perforare/Avviare.....	128		
Lindorf, Divaricatore.....	40, 41		
Lindorf, Strumento per Espiantazione.....	127		
<b>M</b>			
Mobilizzat per Mascella, Obwegeser.....	91		
<b>O</b>			
Osteotomo, Bauer.....	66		
Osteotomo, Dautrey-Munro.....	66		
Osteotomo, Dunn-Dautrey.....	67		
Osteotomo, Epker-Bauer.....	66		
Osteotomo, Epker.....	67, 68		
Osteotomo, Hargis.....	72		
Osteotomo, Marchac.....	115		
Osteotomo, Obwegeser.....	88, 91		
Osteotomo, Steinhäuser.....	78		
Osteotomo, Terry.....	75		
Osteotomo, Tessier.....	97, 98, 107		
Osteotomo Nasale, Obwegeser.....	87		
Osteotomo Palatale.....	107		
Osteotomo per Setto Nasale, Tessier.....	107		
Osteotomo Steinhäuser.....	80		
Osteotomo Steinhäuser per Ramo.....	78		
Osteotomo Wolford.....	80		
<b>P</b>			
Paio Cuscino di Gomma per Pinza Young.....	31		
Perfor., Tessier.....	102		
Periostotomo, Obwegeser.....	51, 52		
Periostotomo, Marchac.....	111		
Periostotomo, Obwegeser.....	85, 86		
Periostotomo Doppio, Obwegeser.....	86		
Pinza, Dolwick.....	62		
Pinza, Rowe.....	56		
Pinza con Catena, Hargis.....	72		
Pinza Jeter-Van Sickels.....	58		
Pinza Obwegeser Piatta.....	93		
Pinza Obwegeser Piatta Punta Retta.....	93		
Pinza per Afferrare Ossa, Obwegeser.....	94		
Pinza per Afferrare Ossa, Keen.....	59		
Pinza Per Allargare, Marchac.....	115		
Pinza per Allargare, Tessier.....	110		
Pinza per Cuio Capelluto, Tessier.....	95		
Pinza per Formare Ossa, Tessier.....	101		
Pinza per Frammenti, Obwegeser.....	89		
Pinza per Muscolo, Terry.....	74		
Pinza per Ossa, Salyer.....	60		
Pinza per Ossa, Steinhäuser.....	59		
Pinza per Ossa, Tessier.....	101		
Pinza per Ossa, Wolford.....	60		
Pinza per Ramo, Obwegeser.....	84		
Pinza per Ramo, Smith.....	73		
Pinza per Ramo, Steinhäuser, destra.....	77		
Pinza per Ramo, Steinhäuser, sinistra.....	77		
Pinza per Riduz., Tessier.....	109		
Pinza Tagliaossa, Tessier.....	101		
Pinza TC, Obwegeser, Punta Grossa.....	93		
Pinza TC, Obwegeser.....	93		
Pinza Tiralingua Collin.....	31		
Pinza Tiralingua Young.....	31		
Placca per Palato.....	21		
Portatovaglioli, Adams.....	18		
Posizionatore, Terry.....	75		
Posizionatore per Filo, Rowe.....	53		
Posizionatore per Filo.....	53		
Proteggidito, Langenbeck.....	18		
Punta Centre Drive®.....	127		
Punta Cross Drive.....	127		
Punteruolo per Mandibola, Obwegeser.....	92		
Punteruolo per Zigomo, Obwegeser.....	92		
Punteruolo Tessier Transnasale.....	102		
<b>R</b>			
Raspa, Dolwick.....	63, 64		
Retrat. Tessier Mail.....	103		
Retrattore, Obwegeser.....	84		
Retrattore, Obwegeser.....	84		
Retrattore, Terry.....	75		
Retrattore Guancia, Obwegeser.....	27		
Retrattore Intraorale.....	34		
Retrattore Intraorale.....	34		
Retrattore Labbro Superiore.....	120		
Retrattore Nervo Sinfisi Mandibolare.....	120		
Retrattore Ishi.....	38, 39		
<b>S</b>			
Sagoma Frontale Marchac Bambini/Adulti.....	112		
Sagoma Frontale Marchac per Neonati.....	112		
Separatore, Hargis.....	69		
Separatore, Obwegeser.....	43, 83, 84		
Separatore, Schuchardt-Lauer.....	50		
Separatore, Turvey.....	76		
Separatore Extraorale, Eckelt.....	32, 33		
Separatore Extraorale.....	32, 33		
Separatore Hargis per Bordo Anteriore.....	70		
Separatore Intraorale.....	35		
Separatore Intraorale L&M.....	36		
Separatore Lauer per Progenismo.....	47, 49		
Separatore per Mento, Obwegeser.....	44		
Separatore per Ossa, Obwegeser.....	90		
Separatore per Progenismo, Metz.....	45		
Separatore per Progenismo, Schuchardt.....	45		
Separatore per Vestibulo.....	27		
Separatore Sagittale, Smith.....	73		
Separatore Shea con Luce Fredda.....	37		
Set Apribocca, Davis-Boyle.....	23		
Set Apribocca, Kilner-Doughty.....	20, 21		
Set Apribocca, Mclvor.....	24		
Set Apribocca, Neukam.....	22		
Set di 3 div., Oringer.....	26		
Specolo Nasale, Tessier.....	96		
Strum. Di Riposizion. Condilare.....	52		
Strum. per Riduzione, Steinhäuser.....	78		
Strumento Per Riposiz. Placche, Eckelt.....	58		
Supporto Contro-Petto per Apribocca.....	20		
<b>T</b>			
Telaio Apribocca, Davis-Boyle.....	23		
Telaio Apribocca, Davis-Boyle.....	23		
Telaio Apribocca, Kilner-Doughty.....	21		
Telaio Apribocca, Mclvor.....	24		
Telaio per Apribocca.....	22		
Trequarti, Tessier.....	102		
Tronchesino, Obwegeser.....	93		
Turat. Terry.....	16		
<b>U</b>			
Uncino per Ossa, Marchac.....	115		





## KLS Martin Group

### **KLS Martin Australia Pty Ltd.**

Sydney · Australia  
Tel.: +61 2 9439 5316  
australia@klsmartin.com

### **KLS Martin do Brasil Ltda.**

São Paulo · Brazil  
Tel.: +55 11 3554 2299  
brazil@klsmartin.com

### **KLS Martin Medical (Shanghai) International Trading Co., Ltd.**

Shanghai · China  
Tel. +86 21 5820 6251  
china@klsmartin.com

### **KLS Martin India Pvt Ltd.**

Chennai · India  
Tel. +91 44 66 442 300  
india@klsmartin.com

### **Martin Italia S.r.l.**

Milan · Italy  
Tel. +39 039 605 67 31  
italia@klsmartin.com

### **Nippon Martin K.K.**

Tokyo · Japan  
Tel. +81 3 3814 1431  
nippon@klsmartin.com

### **KLS Martin SE Asia Sdn. Bhd.**

Penang · Malaysia  
Tel.: +604 505 7838  
malaysia@klsmartin.com

### **Martin Nederland/Marned B.V.**

Huizen · The Netherlands  
Tel. +31 35 523 45 38  
nederland@klsmartin.com

### **Gebrüder Martin GmbH & Co. KG**

Moscow · Russia  
Tel. +7 499 792-76-19  
russia@klsmartin.com

### **Gebrüder Martin GmbH & Co. KG**

Dubai · United Arab Emirates  
Tel. +971 4 454 16 55  
middleeast@klsmartin.com

### **KLS Martin UK Ltd.**

London · United Kingdom  
Tel. +44 1189 000 570  
uk@klsmartin.com

### **KLS Martin LP**

Jacksonville · Florida, USA  
Tel. +1 904 641 77 46  
usa@klsmartin.com

### **Gebrüder Martin GmbH & Co. KG**

#### **A company of the KLS Martin Group**

KLS Martin Platz 1 · 78532 Tuttlingen · Germany  
P.O. Box 60 · 78501 Tuttlingen · Germany  
Tel. +49 7461 706-0 · Fax +49 7461 706-193  
info@klsmartin.com · www.klsmartin.com

