



Advanced Surgical Devices



2012 Product Catalog

## A Knee Arthroscopy

Meniscal Repair Systems.....	A-1	ACL Revision REDUX° System.....	A-40
FAST-FIX° 360 (all-inside) .....	A-1	ACL Revision REDUX° System Cross Reference Index.....	A-41
ULTRA FAST-FIX° .....	A-1	HEALICORE° Trepine System.....	A-42
T-FIX° (all inside).....	A-2	TRE-CORE Trepine System.....	A-43
Meniscus Mender II (outside-in).....	A-3	TUNDRA° PCL Aimer System.....	A-44
Meniscal Stitcher Set (inside-out).....	A-4	ACUFEX° DIRECTOR PCL System.....	A-45
Diamond Rasps .....	A-5	ACUFEX° DIRECTOR System Set Components .....	A-46
ACL/PCL Fixation Systems.....	A-6	Offset Guides and Aimers .....	A-48
ENDOBUTTON° Family of Fixation Devices .....	A-6	Rear Entry Components .....	A-49
BIOSURE° SYNC Tibial Fixation Device.....	A-10	Drill Bits, Routers and Bone Graft Components .....	A-50
BIOSURE° HA and BIOSURE PK Interference Screws.....	A-11	Sizing Tubes, Dilators and Blocks .....	A-53
BIOSURE° Instrumentation.....	A-12	ACL Arthroplasty Instruments .....	A-54
BIORCI°-HA Screws .....	A-13	MCL MicroPerforation Instruments .....	A-57
BIORCI° Screws.....	A-14	Bone Tunnel Plugs .....	A-57
BIORCI° Screw Instrumentation System.....	A-15	Isometry.....	A-58
RCI Screws .....	A-16	Cruciate Pins and Wires.....	A-59
RCI Screw Instrumentation.....	A-17	Chondral Resurfacing Systems.....	A-66
ENDO-FIX° L Screw System.....	A-18	MOSAICPLASTY° .....	A-66
SOFTSILK° Screw Systems .....	A-19	Patient Positioning .....	A-69
TRAILBLAZER° Wire Guides, Screw Guides and Screw Guide Wires.....	A-23	SPIDER2 Limb Positioner .....	A-69
Spiked Washer/Tibial Anchor .....	A-24	Cruciate Reconstruction.....	A-70
Fixation Posts .....	A-25	Leg Holder, Pads and Inserts .....	A-70
Suture Fixation .....	A-26	ARTHROPAK.....	A-71
Graft Sleeve and Tissue Cinch .....	A-27	Customized Procedure Kit .....	A-71
Graft Harvesting Instruments.....	A-28		
Graft Harvesting/Preparation.....	A-29		
GRAFTMASTER° III and GTS Preparation System .....	A-29		
ACL/PCL Reconstruction Drill Guide System.....	A-31		
CLANCY™ Anatomic Cruciate Guide/Flexible Drill System .....	A-31		
ACUFEX° PINPOINT Anatomic ACL Guide System .....	A-32		
ACUFEX° Anatomic ACL Guide System .....	A-33		
ACUFEX° DIRECTOR ACL System Sets .....	A-34		
ACUFEX° DIRECTOR APPLICATION Anatomic Guide.....	A-39		
		<b>B Shoulder Arthroscopy</b>	
		Rotator Cuff Soft Tissue Fixation.....	B-1
		HEALICOIL° PK Suture Anchors (non-absorbable) .....	B-1
		Rotator Cuff Soft Tissue Fixation.....	B-2
		TWINFIX° Ultra HA Suture Anchors .....	B-2
		TWINFIX° Ultra Suture Anchors with Needles..	B-5
		Rotator Cuff Soft Tissue Fixation – Absorbable Polymer Anchors.....	B-6
		TWINFIX° AB 5.0 and TWINFIX AB 6.5 Suture Anchors .....	B-6

Rotator Cuff Soft Tissue Fixation – Absorbable Anchors.....	B-7	TWINFIX® Ti 3.5 and TWINFIX Ti 2.8 Suture Anchors.....	B-23
Rotator Cuff Soft Tissue Fixation – Non-absorbable Polymer Anchors.....	B-8	Instability System .....	B-24
TWINFIX® PK FT Suture Anchors.....	B-8	ELITE® PREMIUM Instability System .....	B-24
Rotator Cuff Soft Tissue Fixation – Metallic Anchors .....	B-9	Instability Soft Tissue Fixation – Non-absorbable Polymer Anchors.....	B-25
TWINFIX® Ti 5.0 and TWINFIX Ti 6.5 Suture Anchors.....	B-9	KINSA® Suture Anchor.....	B-25
.....	B-10	Instability Soft Tissue Fixation – Tissue Tacks... B-26	
TWINFIX Ti QUICK-T Fixation System.....	B-10	SURETAC® Instrumentation Components.....	B-26
Rotator Cuff Soft Tissue Fixation – Metallic Anchors .....	B-11	Biceps Tenodesis Repair .....	B-27
Individually Packaged Anchors and Accessories .....	B-11	BICEPTOR® Tenodesis System.....	B-27
Rotator Cuff Soft Tissue Fixation.....	B-12	Suture Fixation .....	B-29
FOOTPRINT Ultra PK Suture Anchor .....	B-12	ULTRABRAID® High Strength Suture .....	B-29
Rotator Cuff Soft Tissue Fixation – Non-absorbable Polymer Anchors.....	B-13	Patient Positioning .....	B-30
FOOTPRINT PK Suture Anchor.....	B-13	SPIDER2 and SPIDER Limb Positioners .....	B-30
KINSA® RC Suture Anchor.....	B-14	SPIDER2 Limb Positioner and Accessories.....	B-31
Instability Soft Tissue Fixation.....	B-15	SPIDER2 and SPIDER Limb Positioners and Accessories.....	B-32
BIORAPTOR® CURVED and OSTEORAPTOR® CURVED Suture Anchors and Guide System.....	B-15	T-MAX System (beach chair positioner).....	B-33
Instability Soft Tissue Fixation – Non-absorbable Polymer Anchors.....	B-16	T-MAX Shoulder Positioners and Accessories .....	B-34
BIORAPTOR® 2.3 Suture Anchors.....	B-16	Components and Accessories .....	B-35
Instability Soft Tissue Fixation – Suture Anchors B-17		Elbow Joint Positioners .....	B-36
BIORAPTOR® Knotless Suture Anchors.....	B-17	Disposable Kits for Shoulder Arthroscopy .....	B-37
OSTEORAPTOR® 2.3 Suture Anchors.....	B-18	Shoulder Traction Products.....	B-38
OSTEORAPTOR® 2.9 Suture Anchors.....	B-19	Access Disposable Cannulas.....	B-39
Instability Soft Tissue Fixation – Absorbable Polymer Anchors.....	B-20	CLEAR-TRAC® COMPLETE Disposable Cannula System.....	B-39
BIORAPTOR® 2.9 Suture Anchors.....	B-20	CLEAR-TRAC® FLEXIBLE Disposable Cannula System.....	B-40
Instability Soft Tissue Fixation – Absorbable Polymer Anchors.....	B-21	Access.....	B-41
BIORAPTOR® 2.9 AB Suture Anchor with Needles .....	B-21	Portal Accessory System .....	B-41
Instability Soft Tissue Fixation – Non-absorbable Polymer Anchors.....	B-22	Portal Accessory System .....	B-42
BIORAPTOR® 2.3 PK Suture Anchor with Needles .....	B-22	Suture Passing Instrumentation .....	B-43
Instability Soft Tissue Fixation – Metallic Anchors .....	B-23	ELITE® PASS Premium Arthroscopic Suture Shuttle .....	B-43
		ACCU-PASS® Suture Shuttle .....	B-44
		Reusable Suture Shuttle Instrumentation.....	B-45
		ELITE® CUFF STITCH® Suture Relays .....	B-46
		Shoulder Arthroscopy System.....	B-47
		ELITE® PREMIUM II Shoulder Arthroscopy System	

.....	B-47
Instrumentation .....	B-48
ELITE° PREMIUM Shoulder Instruments.....	B-48
ELITE° PREMIUM Shoulder Instruments.....	B-49
Arthroscopic Capsular Release .....	B-50
Accessories.....	B-50
ARTHROPAK.....	B-51
Customized Procedure Kit .....	B-51

## C Hip Arthroscopy

Visualization .....	C-1
Patient Positioning .....	C-2
Supine Hip Positioning System.....	C-2
Lateral Hip Positioning System .....	C-3
Quick Reference OR Table Compatibility Chart.....	C-4
SPIDER2 and SPIDER Hip Positioning Systems.....	C-5
Guide Systems.....	C-6
CROSSTRAC° Hip Guide System.....	C-6
Hip Arthroscopy Set.....	C-7
Cannulas and Obturators .....	C-7
Cannulas, Obturators and Irrigation Extenders.....	C-8
Hand Instruments and Accessories .....	C-8
Monopolar Hip Probes.....	C-11
VULCAN° RF System Hip Probe Indications.....	C-11
VULCAN° RF System Probes .....	C-12
Hip Shaver Blades and Burrs.....	C-13
DYONICS° High Visibility and Extended Length Blades and Burrs.....	C-13
Repair Products.....	C-14
Suture, Suture Anchors and Instruments.....	C-14
Suture, Suture Anchors and Instruments.....	C-15
Drill Guides, Suture Anchors and Instruments .....	C-16
HIPSTRUMENTS Hip Arthroscopy Repair System .....	C-17
Cannula Systems .....	C-18
CLEAR-TRAC° COMPLETE Disposable Hip Cannula System.....	C-18

ARTHROPAK.....	C-19
Customized Procedure Kit .....	C-19

## D Extremities Arthroscopy

DYNAMITE° 2.0 mm PEEK.....	D-1
MINITAC° 2.0 mm Ti.....	D-1
MINITAC 2.0 mm Suture Anchor .....	D-1
RAPTORMITE 3.7 mm PLLA .....	D-1
SPYROMITE 2.0 mm .....	D-1
Suture Anchors and Anchor Accessories .....	D-1
Patient Positioning .....	D-2
FERKEL™ Thigh System.....	D-2
Patient Positioning .....	D-3
Limb Positioners.....	D-3
Instrumentation .....	D-5
Foot and Ankle Instruments.....	D-5
Wrist and Ankle Instruments .....	D-6
Hand and Wrist Instruments.....	D-7
Cannula Sets.....	D-8
Shaver System, Blades and Burrs .....	D-11
DYONICS° POWERMINI° Shaver System .....	D-11
DYONICS° Motor Drive Units and Shaver Systems .....	D-12
Visualization .....	D-13
Small Joint Arthroscopes .....	D-13
Procedure Specific Solutions .....	D-15
Triangular Fibrocartilage Complex.....	D-15
Flexor Tendon Release – Trigger Finger System .....	D-16
Carpal Tunnel Ligament – ECTRA° II System ..	D-17
Carpal Tunnel Ligament Repair – ECTRA° II System.....	D-19
ARTHROPAK.....	D-22
Customized Procedure Kit .....	D-22

## E Advanced Biomaterials

Tissue Repair.....	E-1
TRUFIT® CB Plug Kits.....	E-1
TRUFIT® BGS Plug Kits.....	E-2
TRUKOR® Plus Instruments and Drill Sleeves ...	E-3

## F Sterile Disposable Blades and Burrs

Single-use Blades.....	F-1
DYONICS® PLATINUM Series Blades.....	F-1
DYONICS® PLATINUM Series Blades.....	F-2
DYONICS® ELECTROBLADE® Resector.....	F-3
DYONICS® BONECUTTER® Blades.....	F-4
DYONICS® ORBIT® Curved Blades.....	F-5
DYONICS® Curved Blades.....	F-6
DYONICS® Straight Blades.....	F-7
DYONICS® Straight Blades.....	F-8
Single-use Burrs.....	F-9
DYONICS® Straight Burrs.....	F-9
Hip Shaver Blades and Burrs.....	F-10
DYONICS® High Visibility and Extended Length Blades and Burrs.....	F-10
Single-use Extremity Blades and Burrs.....	F-11
DYONICS® POWERMINI® Small Joint Shaver System .....	F-11
Mini Blades and Burrs.....	F-12
Short Sheath and Obturator Components.....	F-13

## G Shaver Systems

DYONICS® POWER Shaver Systems.....	G-1
DYONICS POWER II Shaver Control System.....	G-1
DYONICS Shaver Handpieces.....	G-2
Accessories.....	G-3
Replacement Parts.....	G-4

## H Powered Instruments

DYONICS® POWER Instrumentation.....	H-1
Battery Operated Power Equipment.....	H-1
Accessories.....	H-2
Charger, Power Pack and Chuck Key.....	H-2
Sterile, Disposable Saw Blades†.....	H-3
DYONICS® POWER Instrumentation.....	H-4
Corded Power Equipment.....	H-4
Accessories.....	H-6
Wire Driver, Pin Driver, Chucks and Cable.....	H-6
Disposable Saw Blades for DYONICS® POWER Instrumentation.....	H-7
Calibrated Sagittal Saw Blades.....	H-8

## I Electrosurgery

DYONICS® RF Arthroscopy System.....	I-1
DYONICS RF System.....	I-1
DYONICS RF System Probe Indications.....	I-2
DYONICS RF System Bipolar Probes.....	I-3
DYONICS RF System Probe Indications – Canada Only Part Numbers.....	I-4
DYONICS RF System Bipolar Probes – Canada Only Part Numbers.....	I-5
VULCAN® RF Arthroscopy System.....	I-6
VULCAN RF Arthroscopy System.....	I-6
VULCAN RF System Probe Indications.....	I-7
SAPHYRE® Bipolar Ablation Probes.....	I-8
ABLATOR® and SCULPTOR® Monopolar Ablation Probes.....	I-9
DYONICS® GLIDER® Monopolar Articular Cartilage Probe.....	I-10
Temperature Control Monopolar Probes.....	I-11
LIGAMENT CHISEL® Monopolar Probes.....	I-12
Single-use Blades.....	I-13
DYONICS® ELECTROBLADE® Resector.....	I-13
Monopolar Hip Probes.....	I-14
VULCAN® RF System Probe Hip Indications.....	I-14
VULCAN® RF System Probes.....	I-15

VULCAN® RF Arthroscopy System .....	I-16
Extremity Radiofrequency Probes .....	I-16
Arthroscopic Electrodes, Probes and Switchpens I-17	
ACUFEX® and ACUFEX Pro .....	J-1
Handles and Tips .....	J-1
Tip Selection Guide .....	J-1

## J Punches, Scissors, Graspers and Knives

Punches .....	J-2
Suction Punches .....	J-7
Punches and Accessories .....	J-7
Accessories .....	J-7
Scissors .....	J-8
Graspers .....	J-9
Extremity Instruments .....	J-11
ACUFEX® .....	J-13
Knives .....	J-13
Probes .....	J-14
Instrument Sterilization Tray .....	J-15
Recommended Handheld Instrument .....	J-16
Recommended Handheld Instrument Starter Kits .....	J-17
Comprehensive Set .....	J-17
Care and Maintenance .....	J-18
Cleaning, Lubrication and Resharpenering/ Preventive Maintenance .....	J-18

## K Arthroscopic Cannula Systems

Cannulas, Trocars and Obturators .....	K-1
Diagnostic Cannula Sets .....	K-1
Operative Cannulas .....	K-2
Irrigation Extenders .....	K-3
Obturators and Trocars .....	K-4
Operative Cannula Sets – 4.5 mm .....	K-5

Operative Cannula Sets – 5.5 mm .....	K-6
Hip Arthroscopy Set .....	K-7
Cannulas and Obturators .....	K-7
Irrigation Extender .....	K-8
Extremity Cannula Sets .....	K-9
Reusable Cannulas .....	K-11
Cannulas for Use with Arthroscopes .....	K-13
Access Disposable Cannulas .....	K-14
CLEAR-TRAC® COMPLETE Disposable Cannula System .....	K-14
CLEAR-TRAC® FLEXIBLE Disposable Cannula System .....	K-15
CLEAR-TRAC® Cannulas .....	K-16
Disposable .....	K-17
Cannulas .....	K-17
Cannulae .....	K-18
Replacement O-Rings .....	K-20
Quick Reference Chart .....	K-20
ARTHROPAK .....	K-21
Customized Procedure Kit .....	K-21

## L Fluid Management

DYONICS® 25 Fluid Management System .....	L-1
Tube Sets and Accessories .....	L-2
DYONICS 25 Carts .....	L-3
Irrigation Systems .....	L-4
Access 15 Irrigation System .....	L-4
ARTHROPAK .....	L-5
Customized Procedure Kit .....	L-5

## M Scopes

VideoArthroscopes .....	M-1
Autoclavable .....	M-1
Non-Autoclavable .....	M-2
Direct-View Arthroscopes .....	M-4
Specialty Endoscopes .....	M-6

ECTRA® II Carpal Ligament System and Replacement Parts .....	M-6
Laparoscopes .....	M-7
Direct-View Autoclavable Laparoscopes .....	M-7
Direct-View Operative Laparoscopes and Accessories .....	M-8
Endoscope and Laparoscope Accessories .....	M-8
Hysteroscopes, Cystourethrosopes and Hysteroscopic Sheaths .....	M-9

## N Surgical Video

Camera Systems .....	N-1
560P Camera Control Unit and 560H Camera Head .....	N-1
HD1200 Autoclavable Camera System .....	N-2
ACL/PCL Reconstruction Drill Guide Systems .....	N-3
ACUFEX® DIRECTOR APPLICATION Anatomic Guide .....	N-3

## O Video Accessories

Video Image Capture Devices .....	O-1
660HD Image Management System .....	O-1
Video Monitors .....	O-2
Video Printers and Recorders .....	O-3
Video Printer Paper and Printer Accessories .....	O-4
Video Couplers and Adapters .....	O-5
Video and Accessory Cables .....	O-7
Video Carts and Accessories .....	O-8

## P Illumination Equipment

Light Sources .....	P-1
Xenon Light Source .....	P-1
Light Sources .....	P-2
Light Source Replacement Parts .....	P-2
Fiber Optic Light Cables and Adaptors .....	P-3
Compatibility Matrix .....	P-5

## Q Sterilization Trays and Miscellaneous Accessories

Storage and Sterilization Trays .....	Q-1
Miscellaneous .....	Q-4
Personal Protection Items .....	Q-4
Fracture Support Table .....	Q-5

## R Laparoscopy

Laparoscopes .....	R-1
Laparoscopes and Accessories .....	R-2
Hysteroscopes, Cystourethrosopes and Hysteroscopic Sheaths .....	R-3
400 Insufflator .....	R-4
INTERCEPTRE Modular Instruments .....	R-5
Laparoscopic Instruments .....	R-7

## Sales and Service Policies

Sales and Service Policies .....	x
Trademarks .....	xi
Patents .....	xii
Returned Goods Policy .....	xiii
Global Services .....	xiv
Global Services Benefits .....	xiv
US Programs .....	xiv
Factory Service .....	xv
Replacement Plan .....	xv
Service Exchange .....	xv
Repair .....	xv
On-site Service .....	xvi
On-site Service .....	xvi
ACUFEX® Edge Express .....	xvi
Service Program Notes .....	xvii
Eligibility .....	xvii
Return Authorization Process .....	xvii
Serial Numbers .....	xvii

Standard Warranty Versus

Service Agreement ..... xvii  
Product End-of-Support ..... xvii  
Service Centers ..... xviii  
New Product Warranty ..... xix  
Service Replacement and Repair Warranty ..... xix  
All service replacement and repairs have a 90 day  
limited warranty ..... xix  
International Contacts ..... xx  
Financial Services ..... xxi  
Financial Benefits ..... xxi  
Financial Programs ..... xxi

Index



**FAST-FIX<sup>®</sup> 360**  
Meniscal Repair System



- One-handed, fast-click implant deployment
- Minimal needle exposure behind the capsule
- Minimal disruption to the meniscus
- Greater access with improved control and implant delivery

---

**ENDOBUTTON<sup>®</sup>**  
Family of Fixation Devices



- Market-leading solution for femoral fixation
- Clinically proven with over 10 years of clinical success
- Strong and efficient

## Meniscal Repair Systems

### FAST-FIX<sup>®</sup> (all-inside)

#### FAST-FIX 360

The FAST-FIX 360 meniscal repair system offers exceptional fixation strength, easier implant deployment, smaller insertion points that minimize disruption to the meniscus, a built in depth penetration limiter and a stiffer needle shaft for enhanced control. All this to help optimize the meniscus repair.

Reference #	Description
72202467	FAST-FIX 360 straight
72202468	FAST-FIX 360 curved
72202469	FAST-FIX 360 reverse curved
72202674	FAST-FIX 360 Straight Knot Pusher/Cutter and Slotted Cannula sets
72202675	FAST-FIX 360 Curved Knot Pusher/Cutter and Slotted Cannula sets

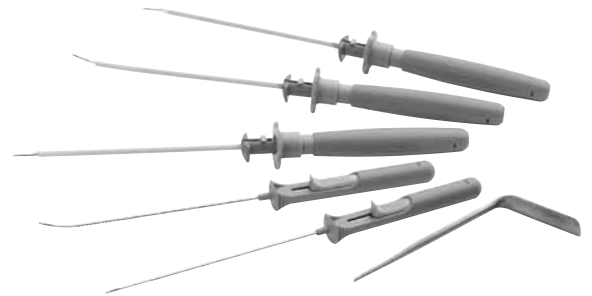

#### ULTRA FAST-FIX

Reference #	Description
72201490	ULTRA FAST-FIX, straight
72201493	ULTRA FAST-FIX, AB, straight
72201491	ULTRA FAST-FIX, curved
72201494	ULTRA FAST-FIX AB, curved
72201492	ULTRA FAST-FIX, reverse curved
72201495	ULTRA FAST-FIX AB, reverse curved
72201537	Knot Pusher/Suture Cutter, straight



#### Probe, Rasp and Accessories

015186	Meniscal Depth Probe
014549	45° Diamond Rasp
014550	90° Diamond Rasp
011703	Sterilization Tray, 9.25" W x 3" L x 1.5" H
7210977	Slotted Cannula
7209950	Suture Threaders, sterile (10 per box)
7210450	Suture Funnel, sterile (10 per box)

# Meniscal Repair Systems

## T-FIX<sup>®</sup> (all inside)

### T-FIX Suture Bar

For all inside meniscal repair; 1.0 mm x 6.3 mm Delrin bar on #2-0 braided polyester.

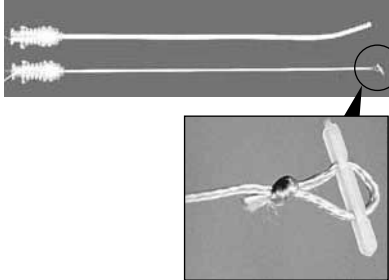

Reference #	Description
-------------	-------------

015182*	1 T-FIX/pack single suture, curved introducer, sterile
015180*	1 T-FIX/pack double suture, straight introducer, sterile
015181	1 T-FIX/pack single suture, straight introducer, sterile

### T-FIX Instrumentation



Reference #	Description
-------------	-------------

015184	Intra-articular Knot Pusher
--------	-----------------------------



Reference #	Description
-------------	-------------

015186	Meniscal Depth Probe, 2 mm markings
--------	-------------------------------------



Reference #	Description
-------------	-------------

014527	T-FIX Suture Cutter, for up to #2-0 suture
--------	--



Reference #	Description
-------------	-------------

014623	Cannula Kit, 5 mm I.D. x 55 mm, includes trocar and obturator, sterile, single-use (10 per box)
--------	---

## Meniscal Repair Systems

### Meniscus Mender II (outside-in)

#### Meniscus Mender II

The Meniscus Mender II, an outside-in suture technique that is designed for repairing the meniscus under direct arthroscopic monitoring. Ideal for anterior horn tears.



Reference #	Description
7209485*	Meniscus Mender II Disposable Set

#### Optional Components

7209477	Straight Suture Passer
7209478	Curved Suture Passer
7209481	Suture Circle
7207357	Large Sterilization Tray with mat, 8" W x 13" L x 1.25" H
7209480	Set Screw for Suture Passer, large
7209483	Set Screw for Suture Passer, small

\* Item shown

## Meniscal Repair Systems

### Meniscal Stitcher Set (inside-out)

Meniscal Stitcher Set  
For inside-out meniscal repair

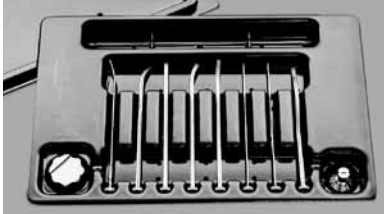

Reference #	Description
012600	Meniscal Stitcher Set
<b>System includes</b>	
012601	Double Lumen Cannula, curved up-right
012602	Double Lumen Cannula, curved up-left
012603	Double Lumen Cannula, straight
012604	Double Lumen Cannula, curved left/right
012605	Double Lumen Cannula, curved up/down
012606	Single Cannula (2 included with set)
012609	Thimble
012610	Posterior Access Cannula
012612	Bending Tool
011702	Sterilization Tray for Meniscal Stitcher Set

<b>Disposables</b>	
72202868	Needles, straight, sterile (6 per package)

#### Meniscal Stitching Needles



Reference #	Description
012615	Ti-Cron™ 10 swaged needles with #2-0, 30" long suture, for Meniscal Stitcher Set; non-absorbable, single use, sterile (12 per box)



Reference #	Description
72202868	Needles, straight, sterile (6 per package)

## Meniscal Repair Systems

### Diamond Rasps



#### Diamond Rasps

Designed specifically to freshen the edge of the meniscal tear prior to repair.



Reference #	Description
014549	45° Diamond Rasp



Reference #	Description
014550	90° Diamond Rasp

## ACL/PCL Fixation Systems

### ENDOBUTTON® Family of Fixation Devices



#### ENDOBUTTON CL Ultra Fixation Device

Delivering improved strength and stiffness, the ENDOBUTTON CL ULTRA Fixation device offers the strongest soft tissue femoral fixation currently available. Ideal for anatomic or traditional ACL reconstruction techniques. Preloaded with ULTRABRAID® #5 lead suture (white) and DURABRAID® #5 flipping suture (green) for added procedure efficiency.

Reference #	Description
72203331	10 mm ENDOBUTTON CL ULTRA
72200146	15 mm ENDOBUTTON CL ULTRA
72200147	20 mm ENDOBUTTON CL ULTRA
72200148	25 mm ENDOBUTTON CL ULTRA
72200149	30 mm ENDOBUTTON CL ULTRA
72200150	35 mm ENDOBUTTON CL ULTRA
72200151	40 mm ENDOBUTTON CL ULTRA
72200152	45 mm ENDOBUTTON CL ULTRA
72200153	50 mm ENDOBUTTON CL ULTRA
72200154	55 mm ENDOBUTTON CL ULTRA
72200155	60 mm ENDOBUTTON CL ULTRA



#### ENDOBUTTON DIRECT Fixation Device

The titanium ENDOBUTTON device maximizes the amount of graft in the tunnel, an ideal solution for accommodating shorter femoral tunnels that result from more anatomic placement.

Reference #	Description
72201206	5 mm ENDOBUTTON DIRECT
72202980	5 mm ENDOBUTTON DIRECT with suture
72201207	6 mm ENDOBUTTON DIRECT
72202981	6 mm ENDOBUTTON DIRECT with suture
72201208	7 mm ENDOBUTTON DIRECT
72202982	7 mm ENDOBUTTON DIRECT with suture
72201209	8 mm ENDOBUTTON DIRECT
72202983	8 mm ENDOBUTTON DIRECT with suture
72201210	9 mm ENDOBUTTON DIRECT
72202984	9 mm ENDOBUTTON DIRECT with suture
72201211	10 mm ENDOBUTTON DIRECT
72202985	10 mm ENDOBUTTON DIRECT with suture
72201212	ENDOBUTTON DIRECT Holder
72201600	ENDOBUTTON DIRECT Scale

## ACL/PCL Fixation Systems

### ENDOBUTTON® Family of Fixation Devices



#### ENDOBUTTON CL BTB Fixation Device

ENDOBUTTON CL BTB provides dependable fixation for bone-tendon-bone ACL reconstruction procedures.

Reference #	Description
72203330	15 mm ENDOBUTTON CL BTB
7210080	20 mm ENDOBUTTON CL BTB
7210081	25 mm ENDOBUTTON CL BTB
7210082	30 mm ENDOBUTTON CL BTB
7210083	35 mm ENDOBUTTON CL BTB
7210084	40 mm ENDOBUTTON CL BTB
7210085	45 mm ENDOBUTTON CL BTB
7210086	50 mm ENDOBUTTON CL BTB
7210087	55 mm ENDOBUTTON CL BTB
7210088	60 mm ENDOBUTTON CL BTB



#### XTENDOBUTTON Fixation Device

The Smith & Nephew XTENDOBUTTON Fixation Device, used in conjunction with any Smith & Nephew ENDOBUTTON device, allows a 6 to 10 mm area of the femoral tunnel to be covered. In addition to providing an effective solution for cortical blowouts, this device can accommodate a variety of femoral tunnel drilling techniques including inside-out, outside-in and medial portal.

Reference #	Description
72200134	XTENDOBUTTON Fixation Device



## ACL/PCL Fixation Systems

### ENDOBUTTON® Family of Fixation Devices



#### CL Device

Continuous loop of suture eliminates the need for knot tying. Ideal for a post or screw-and-washer technique.

Reference #	Description
72200839	25 mm CL Device
72200840	30 mm CL Device
72200841	35 mm CL Device
72200842	40 mm CL Device
72200843	45 mm CL Device
72200844	50 mm CL Device



#### ENDOBUTTON Fixation Device

This titanium button is the original endoscopic femoral soft tissue fixation device, and where the ENDOBUTTON revolution began. It can be used for single incision, soft tissue or bone-tendon-bone fixation.

Reference #	Description
013186	ENDOBUTTON, 4.0 mm x 12 mm

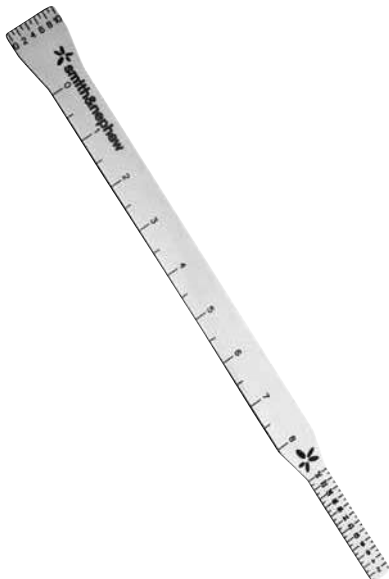

#### TRUKOR® Depth Gauge

This TRUKOR Depth Gauge easily estimates the native dimensions of the ACL for tunnel sizing.

Reference #	Description
72200948	TRUKOR Depth Gauge

## ACL/PCL Fixation Systems

### ENDOBUTTON<sup>®</sup> Family of Fixation Devices



#### ENDOBUTTON Indicator Selection Device

The Endobutton Indicator is intended to aid the surgeon in the selection of an ENDOBUTTON CL device.

Reference #	Description
72202544	ENDOBUTTON Indicator

#### The Indicator can be used with any of the following pins:

014508	Drill Tip passing pin, 2.7 mm x 15", sterile, (6 per box)
7208678	Drill Tip passing pin, 2.4 mm x 15", sterile, single use
7207220	TROCAR-Tip passing pin, 2.4 mm x 17", sterile, single use
72201594	2.4 mm flexible passing pins, sterile (5 per package)

#### ENDOBUTTON Accessories

Reference #	Description
014868	ENDOBUTTON Tape with Passing Needle, 24" (60 cm) (12 per box)

The only surgical tape cleared for use with ENDOBUTTON Fixation Device.



7207315	Endoscopic Cannulated Drill bit, 4.5 mm (use with ENDOBUTTON, ENDOBUTTON CL or RCI screws), sterile, disposable, single use
---------	---

72202971	Flexible 4.5 mm CLANCY Reamer/Drill Bit
----------	---



015185	ENDOBUTTON Depth Probe
7209951	ENDOBUTTON Adjustable Knob for Depth Probe
3134301	Cannulated Depth Probe

## ACL/PCL Fixation Systems

### BIOSURE<sup>®</sup> SYNC Tibial Fixation Device

The BIOSURE SYNC Tibial Fixation Device is an intra-tunnel tibial fixation device. It was designed to improve graft fixation on the tibial side of ACL repairs, and can accommodate both single- and double-bundle reconstruction as well as primary and revision surgeries. When used to secure soft tissue grafts to bone during cruciate ligament reconstruction, the BIOSURE SYNC device provides industry-leading tibial fixation strength. The device was designed to accommodate a variety of arthroscopic ligament reconstruction techniques, and is the complete solution for cruciate ligament reconstruction.

The device features an outer sheath that employs four wings. As the BIOSURE PK Interference Screw is introduced into the sheath, the wings twist, compressing the graft strands against the bone tunnel walls. The BIOSURE SYNC device organizes the four-strand graft into quadrants, and due to the concentric placement of the device, graft-to-bone contact is maximized, creating an optimal healing environment.

The BIOSURE SYNC Tibial Fixation Device is available in four sizes, accommodating graft diameters from 5 mm to 12 mm. It is molded from PEEK-OPTIMA<sup>®</sup> material by Invibio<sup>®</sup>, offering strength, radiolucency and proven biocompatibility. The instrument system consists of an inserter, tensioner, dilators and an instrument tray. A wide range of BIOSURE PK Interference Screws are available from 6 mm to 11 mm and are also molded from PEEK material. An 18" guidewire is also available.

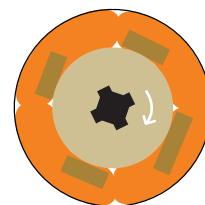
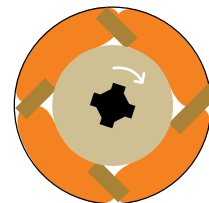
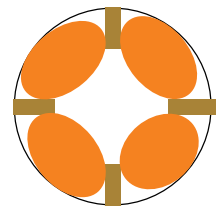

Reference #	Description
72202744	5 mm – 6 mm BIOSURE SYNC Device
72202745	7 mm – 8 mm BIOSURE SYNC Device
72202746	9 mm – 10 mm BIOSURE SYNC Device
72202747	11 mm – 12 mm BIOSURE SYNC Device
72202843	BIOSURE SYNC Instrument System

#### System includes

72202752	BIOSURE SYNC Inserter
72202754	BIOSURE SYNC Tensioner
72202755	5 mm – 6 mm BIOSURE SYNC Dilator
72202756	7 mm – 8 mm BIOSURE SYNC Dilator
72202757	9 mm – 10 mm BIOSURE SYNC Dilator
72202758	11 mm – 12 mm BIOSURE SYNC Dilator
72202753	BIOSURE SYNC Instrument Tray



#### Interference Screw and Other

Reference #	Description
72202260	6 mm x 25 mm BIOSURE PK Screw
72202263	7 mm x 25 mm BIOSURE PK Screw
72202267	8 mm x 25 mm BIOSURE PK Screw
72202272	9 mm x 25 mm BIOSURE PK Screw
72202276	10 mm x 25 mm BIOSURE PK Screw
72202279	11 mm x 25 mm BIOSURE PK Screw
72201201	Guidewire 1.2 mm x 18", box of 5, sterile



## ACL/PCL Fixation Systems

### BIOSURE<sup>®</sup> HA and BIOSURE PK Interference Screws

#### BIOSURE Interference Screw

The BIOSURE family of interference screws provides an all-purpose range of screws and instrumentation. BIOSURE Interference Screws incorporate the latest proven technologies to help you deliver exceptional graft fixation. Available in 24 sizes, including 6 mm screws for double bundle repairs and reverse thread screws for right knees.

#### Absorbable

Our absorbable BIOSURE HA interference screw combines poly-L-lactic acid (PLLA) with hydroxyapatite (HA), a calcium phosphate similar to the mineral compound of bone. Once absorbed, it has the fracture resistance of human corticle bone. Unlike other materials where HA has been derived from animal or coralline sources, our material is completely synthetic and does not exhibit natural variability or immunological hazards.

#### Non-absorbable

Our non-absorbable BIOSURE PK interference screw incorporates PEEK-OPTIMA<sup>®</sup> polymer from Invibio<sup>®</sup>. With a modulus similar to cortical bone, PEEK-OPTIMA material exhibits an ideal combination of strength, stiffness and toughness, together with biocompatibility. BIOSURE PK interference screws offer the revisability of an absorbable screw and inherent radiolucent characteristics from a material that has gained confidence and acceptance in the medical community for 10 years.

#### BIOSURE HA (PLLA-HA)

Reference #	Description
72201768	6 mm x 20 mm BIOSURE HA
72201769	6 mm x 25 mm BIOSURE HA
72201770	6 mm x 25 mm BIOSURE HA reverse thread
72201771	7 mm x 20 mm BIOSURE HA
72201772	7 mm x 25 mm BIOSURE HA
72201773	7 mm x 25 mm BIOSURE HA reverse thread
72201774	7 mm x 30 mm BIOSURE HA
72201775	8 mm x 20 mm BIOSURE HA
72201776	8 mm x 25 mm BIOSURE HA
72201777	8 mm x 25 mm BIOSURE HA reverse thread
72201778	8 mm x 30 mm BIOSURE HA
72201779	8 mm x 35 mm BIOSURE HA
72201780	9 mm x 20 mm BIOSURE HA
72201781	9 mm x 25 mm BIOSURE HA
72201782	9 mm x 30 mm BIOSURE HA
72201783	9 mm x 35 mm BIOSURE HA
72201784	10 mm x 20 mm BIOSURE HA
72201785	10 mm x 25 mm BIOSURE HA
72201786	10 mm x 30 mm BIOSURE HA
72201787	10 mm x 35 mm BIOSURE HA
72201788	11 mm x 25 mm BIOSURE HA
72201789	11 mm x 30 mm BIOSURE HA
72201790	11 mm x 35 mm BIOSURE HA
72201791	12 mm x 35 mm BIOSURE HA

#### BIOSURE PK (PEEK-OPTIMA)

Reference #	Description
72202259	6 mm x 20 mm BIOSURE PK
72202260	6 mm x 25 mm BIOSURE PK
72202261	6 mm x 25 mm BIOSURE PK reverse thread
72202262	7 mm x 20 mm BIOSURE PK
72202263	7 mm x 25 mm BIOSURE PK
72202264	7 mm x 25 mm BIOSURE PK reverse thread
72202265	7 mm x 30 mm BIOSURE PK
72202266	8 mm x 20 mm BIOSURE PK
72202267	8 mm x 25 mm BIOSURE PK
72202268	8 mm x 25 mm BIOSURE PK reverse thread
72202269	8 mm x 30 mm BIOSURE PK
72202270	8 mm x 35 mm BIOSURE PK
72202271	9 mm x 20 mm BIOSURE PK
72202272	9 mm x 25 mm BIOSURE PK
72202273	9 mm x 30 mm BIOSURE PK
72202274	9 mm x 35 mm BIOSURE PK
72202275	10 mm x 20 mm BIOSURE PK
72202276	10 mm x 25 mm BIOSURE PK
72202277	10 mm x 30 mm BIOSURE PK
72202278	10 mm x 35 mm BIOSURE PK
72202279	11 mm x 25 mm BIOSURE PK
72202280	11 mm x 30 mm BIOSURE PK
72202281	11 mm x 35 mm BIOSURE PK
72202282	12 mm x 35 mm BIOSURE PK

## ACL/PCL Fixation Systems

### BIOSURE<sup>®</sup> Instrumentation

#### BIOSURE Guide Wires

Reference #	Description
7211137	Guide Wire, 1.2 mm x 9" sterile (5 per box)
7211138	Guide Wire, 1.2 mm x 12" sterile (5 per box)
72201201	Guide Wire, 1.2 mm x 18" sterile (5 per box)



#### BIOSURE Drivers

Reference #	Description
72201887	BIOSURE Driver
72201888	BIOSURE Ratchet Driver (requires Ratcheting Handle with Hudson Adapter 7207707)
7207707	Ratcheting Handle with Hudson Adapter

#### BIOSURE Tap System

Reference #	Description
72201941	BIOSURE Tap System

#### System includes 1 each of

72201889	6 mm BIOSURE Tap
72201890	7 mm BIOSURE Tap
72201891	8 mm BIOSURE Tap
72201892	9 mm BIOSURE Tap
72201893	10 mm BIOSURE Tap
72201887	BIOSURE Driver
72201938	BIOSURE Tap Tray

#### BIOSURE Easy Tap System

Reference #	Description
72201942	BIOSURE Easy Tap System

#### System includes 1 each of

72201190	6 mm BIOSURE EASY Tap
72201191	7 mm BIOSURE EASY Tap
72201192	8 mm BIOSURE EASY Tap
72201193	9 mm BIOSURE EASY Tap
72201194	10 mm BIOSURE EASY Tap
72201888	BIOSURE Ratchet Driver
7207707	Ratcheting Handle with Hudson Adapter
72201939	BIOSURE EASY Tap Tray
⚙️ 72202475	BIOSURE Extended Length Driver, 9" working length (requires Ratcheting Handle with Hudson Adapter 7207707)

## ACL/PCL Fixation Systems

### BIORCI®-HA Screws



#### BIORCI-HA Screw System Implants

The BIORCI-HA Screw System has proven effectiveness for graft fixation and site repair. BIORCI-HA screws use standard BIORCI instruments and offer 23 screw sizes from which to choose.

Reference #	Description
7207686	7/7 x 20 mm BIORCI-HA
7207674	7/7 x 25 mm BIORCI-HA
7207677	7/7 x 30 mm BIORCI-HA
7207675	7/8 x 25 mm BIORCI-HA
7209023	7/8 x 25 mm BIORCI-HA reverse thread
7207676	7/8 x 30 mm BIORCI-HA
7209012	8 x 20 mm BIORCI-HA
7207678	8 x 25 mm BIORCI-HA
7209021	8 x 25 mm BIORCI-HA reverse thread
7207679	8 x 30 mm BIORCI-HA
7207680	8 x 35 mm BIORCI-HA
7209013	9 x 20 mm BIORCI-HA
7207681	9 x 25 mm BIORCI-HA
7209020	9 x 25 mm BIORCI-HA reverse thread
7207682	9 x 30 mm BIORCI-HA
7207683	9 x 35 mm BIORCI-HA
7209016	10 x 25 mm BIORCI-HA
7209019	10 x 25 mm BIORCI-HA reverse thread
7209017	10 x 30 mm BIORCI-HA
7209018	10 x 35 mm BIORCI-HA
7209014	11 x 30 mm BIORCI-HA
7209022	11 x 35 mm BIORCI-HA
7209015	12 x 35 mm BIORCI-HA
7207636	1.5 mm x 9" (23 cm) Guide Wire, non-sterile (6 per package)
014859	1.5 mm x 12" (30 cm) Guide Wire, sterile (1 per package)

## ACL/PCL Fixation Systems

### BIORCI<sup>®</sup> Screws

#### BIORCI Screws

PLLA Bioabsorbable Interference Screws, 1.5 mm cannulation, blunt threads. Standard and enlarged heads. Sterile, 1 per box.

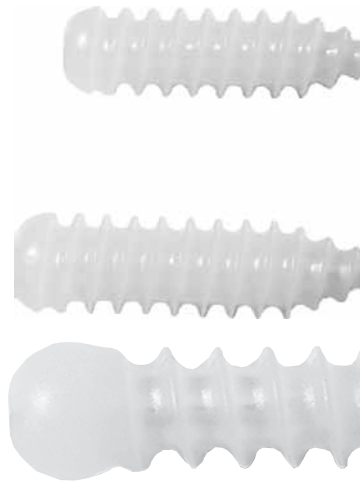

Reference #	Description
7207916	7 x 20 mm BIORCI Screw
7207554*	7 x 25 mm BIORCI Screw
7207607	7 x 25 mm BIORCI Screw with an 8 mm head reverse thread
7207555	7 x 30 mm BIORCI Screw
7207557	7 x 25 mm BIORCI Screw with an 8 mm head
7207558	7 x 30 mm BIORCI Screw with an 8 mm head
7207918	8 x 20 mm BIORCI Screw
7207560	8 x 25 mm BIORCI Screw
7207608*	8 x 25 mm BIORCI Screw reverse thread
7207561	8 x 30 mm BIORCI Screw
7207562	8 x 35 mm BIORCI Screw
7207919	9 x 20 mm BIORCI Screw
7207563	9 x 25 mm BIORCI Screw
7207924	9 x 25 mm BIORCI Screw reverse thread
7207564	9 x 30 mm BIORCI Screw
7207565	9 x 35 mm BIORCI Screw
7207566	10 x 25 mm BIORCI Screw
7207581	10 x 25 mm BIORCI Screw reverse thread
7207567	10 x 30 mm BIORCI Screw
7207568*	10 x 35 mm BIORCI Screw
7207920	11 x 30 mm BIORCI Screw
7207921	11 x 35 mm BIORCI Screw
7207923	12 x 35 mm BIORCI Screw

\* Item shown

⚙ Special, Made to Order products are available to meet the individual needs of surgeons. Please appreciate that longer lead time for delivery should be expected. For more information, please contact your sales representative or Customer Service.

## ACL/PCL Fixation Systems

### BIORCI® Screw Instrumentation System

#### BIORCI Screw Instruments

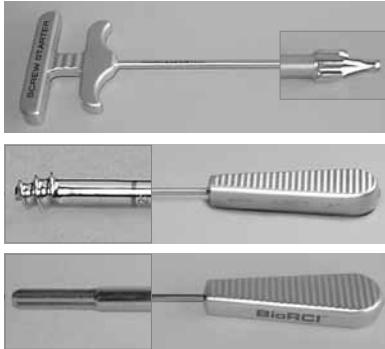

Reference #	Description
7208656*	BIORCI Torx Driver
7207359*	BIORCI Starter
7209371	7 mm BIORCI Threaded Screw Starter for BTB grafts
7209373*	8 mm BIORCI Threaded Screw Starter for BTB grafts
7208661	7 mm BIORCI tap for BTB grafts
7208662	8 mm BIORCI tap for BTB grafts
7208663	9 mm BIORCI tap for BTB grafts
7208664	10 mm BIORCI tap for BTB grafts
7207636	1.5 mm x 9" Guide Wire, non-sterile (6 per package)
014859	1.5 mm x 12" Guide Wire, single use
7207707	Ratcheting Handle with Hudson Adapter
7207369	Medium Sterilization Tray
7207357	Large Sterilization Tray

#### Accessories

Reference #	Description
⚙️ 7207783	BIORCI Ratcheting Handle System (includes REF 7207707 Ratcheting Handle with Hudson Adapter and REF 7207754 Driver with Hudson Adapter)
⚙️ 7207754	Driver, BIORCI and BIORCI-HA, with Hudson Adapter
⚙️ 6901012	BIORCI Driver, 3" extended length, with Hudson Adapter
⚙️ 3134295	BIORCI Driver, with set screw to secure guide wire, with Hudson Adapter
⚙️ 3134214	Driver, Tapered, 3.5 mm hex, non-cannulated



## ACL/PCL Fixation Systems

### RCI Screws



#### 2.0 mm Cannulation RCI Screws

Titanium, 2.0 mm cannulation, blunt threads. Standard and enlarged heads. Sterile, 1 per box.

Reference	Description
7207030	7 x 25 mm RCI Screw with 8 mm head
7207247	7 x 25 mm RCI Screw reverse thread
7209409	7 x 35 mm RCI Screw with 8 mm head
7207250	7 x 40 mm RCI Screw
7207248	8 x 25 mm RCI Screw
7209410	8 x 25 mm RCI Screw reverse thread
7209411	8 x 35 mm RCI Screw
7207249	8 x 40 mm RCI Screw
7207301	9 x 25 mm RCI Screw
7209412	9 x 35 mm RCI Screw
7209779	10 x 25 mm RCI Screw
7209413	10 x 30 mm RCI Screw
7209414	10 x 35 mm RCI Screw
7209415	11 x 30 mm RCI Screw
7209416	11 x 35 mm RCI Screw

#### Cannulated Screw (with 1.0 mm cannulation, Titanium)

Reference	Description
⚙ 7204767	5 x 25 mm cannulated screw
⚙ 7204770	6 x 25 mm cannulated screw
⚙ 7204771	6 x 30 mm cannulated screw

#### Soft-Threaded (with 2.0 mm cannulation)

Reference	Description
⚙ 3134257	7 x 35 mm soft-threaded, non-sterile
⚙ 3134255	8 x 35 mm soft-threaded, non-sterile

#### RCI Screw Instruments

Reference	Description
⚙ 3134091	3.5 mm Hex Driver, Nitinol Tip, with Hudson Adapter. For 7 x 20 mm screws only
⚙ 3134092	3.5 mm Hex Driver, Nitinol Tip, with Hudson Adapter
⚙ 3134299	3.5 mm Hex Driver, 1.5 mm cannulation, shortened 2.2" with Hudson Adapter
⚙ 6901177	3.5 mm Hex Driver, Nitinol Tip, thin shaft, with Hudson Adapter

## ACL/PCL Fixation Systems

### RCI Screw Instrumentation

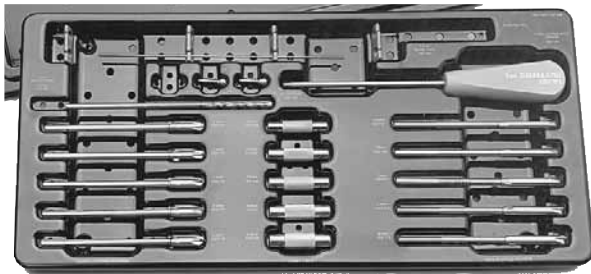

#### RCI Screw System

The RCI Screw is a patented device for use in cruciate reconstruction when using hamstring or patellar tendon grafts. The RCI Screw has blunt threads that protect the grafts from laceration. The round head on the 7 x 25 mm screws reduces the stresses in the graft as it exits the femoral tunnel.

Reference #	Description
7207170	RCI Screw System

#### System includes

7207163	6.5 mm graft sizing tube
013523	7 mm graft sizing tube
7207164	7.5 mm graft sizing tube
013524	8 mm graft sizing tube
7207165	8.5 mm graft sizing tube
7207167	6.5 mm tibial stepped router
7207168	7 mm tibial stepped router
7207171	7.5 mm tibial stepped router
7207172	8 mm tibial stepped router
7207173	8.5 mm tibial stepped router
7207174	6.5 mm femoral stepped router
7207175	7 mm femoral stepped router
7207176	7.5 mm femoral stepped router
7207177	8 mm femoral stepped router
7207178	8.5 mm femoral stepped router
7207193	3.5 mm Hex Driver, 2 mm cannulation
7207169	Sterilization Tray for RCI Screw System
72202881	CANNU-FLEX® Screw Guide Wire, 2 mm x 12" (30 cm), blunt tip, sterile (6 per package)
7207315	Endoscopic Cannulated Drill, 4.5 mm, sterile

# ACL/PCL Fixation Systems

## ENDO-FIX<sup>®</sup> L Screw System

### ENDO-FIX L Screw System

- Poly L lactic acid
- Fixation strength of metal – without metal in the joint
- 1.5 mm cannulation
- Indicated for bone-tendon-bone and soft tissue fixation



Reference #	Description
014542	7 mm ENDO-FIX L Tap
7208667	8 mm ENDO-FIX L Tap
014543	9 mm ENDO-FIX L Tap
7207359*	ENDO-FIX L Screw Starter
7207358*	ENDO-FIX L Driver, 1.5 mm cannulation
7207369	Sterilization Tray for ENDO-FIX L Delivery System

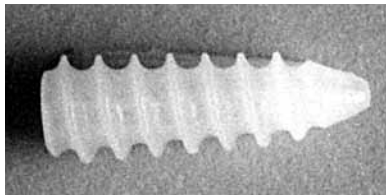

### ENDO-FIX L Bioabsorbable Interference Screws

PLLA Bioabsorbable Interference Screws, 1.5 mm cannulation, sterile, 1 per box.

Reference #	Description
7207480	7 mm diameter x 20 mm, tapered 6.5 mm to 7.5 mm
7207481	7 mm diameter x 25 mm, tapered 6.5 mm to 8.3 mm
7208665	8 mm diameter x 20 mm, tapered 7.5 mm to 8.3 mm
7208666*	8 mm diameter x 25 mm, tapered 7.5 mm to 9.1 mm
7207477	9 mm diameter x 20 mm, tapered 8.6 mm to 9.4 mm
7207478	9 mm diameter x 25 mm, tapered 8.6 mm to 10.2 mm
7207479	9 mm diameter x 30 mm, tapered 8.6 mm to 10.6 mm

### ENDO-FIX L Screw Instruments

Reference #	Description
⚙ 3134016	Tap, 7 mm ENDO-FIX L, with Hudson Adapter
⚙ 3134015	Tap, 9 mm ENDO-FIX L, with Hudson Adapter

\* Item shown

⚙ Special, Made to Order products are available to meet the individual needs of surgeons. Please appreciate that longer lead time for delivery should be expected. For more information, please contact your sales representative or Customer Service.

## ACL/PCL Fixation Systems

### SOFTSILK<sup>®</sup> Screw Systems



#### SOFTSILK 1.5 Screw System

Reference #	Description
7207077	SOFTSILK 1.5 Screw System Sterile screws (3 of each size included with system)

#### System includes

7207001	7 x 20 mm SOFTSILK 1.5
7207002	7 x 25 mm SOFTSILK 1.5
7207003	7 x 30 mm SOFTSILK 1.5
7207004	8 x 20 mm SOFTSILK 1.5
7207005	8 x 25 mm SOFTSILK 1.5
7207006	8 x 30 mm SOFTSILK 1.5
7207007	9 x 20 mm SOFTSILK 1.5
7207008	9 x 25 mm SOFTSILK 1.5
7207009	9 x 30 mm SOFTSILK 1.5
72202428	Instrument Tray
014815	3.5 mm Hex Driver, 1.5 mm cannulation
014851	TRAILBLAZER <sup>®</sup> , 1.5 mm cannulation
014545	CANNU-FLEX <sup>®</sup> Screw Guide Wire, 1.5 mm x 12" (30 cm) (6 per package)

#### Optional

⚙️ 7207704	3.5 mm Hex Driver, 1.5 mm cannulation, with Hudson Adapter, requires REF 7207707 Ratcheting Handle with Hudson Adapter
------------	--

#### SOFTSILK 1.5 Fixation Screws

Titanium, 1.5 mm cannulation, round head, corkscrew tip, soft threads, sterile.



Reference # Screw only	Reference # Sheathed in CLEAR-TRAC <sup>®</sup> Screw Cannula; latex free	Reference # Sheathed in CLEAR-TRAC Screw Cannula; contains latex	Description
7207001	7205640	7210131	7 x 20 mm SOFTSILK 1.5
7207002	7205643	7210132	7 x 25 mm SOFTSILK 1.5
7207003	7205644	7210133	7 x 30 mm SOFTSILK 1.5
7207004	7205641	7210134	8 x 20 mm SOFTSILK 1.5
7207005	7205645	7210135	8 x 25 mm SOFTSILK 1.5
7207006	7205646	7210136	8 x 30 mm SOFTSILK 1.5
7207007	7205642	7210137	9 x 20 mm SOFTSILK 1.5
7207008	7205647	7210138	9 x 25 mm SOFTSILK 1.5
7207009	7205648	7210139	9 x 30 mm SOFTSILK 1.5

## ACL/PCL Fixation Systems

### SOFTSILK<sup>®</sup> Screw Systems

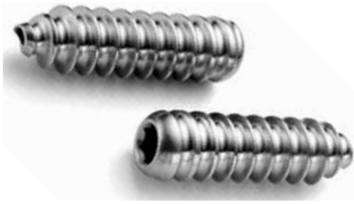

SOFTSILK 1.5 Fixation Screws – sterile

Titanium, 1.5 mm cannulation, round head, corkscrew tip, soft threads, sterile.

Reference #	Description
⚙ 7210760	10 x 25 mm SOFTSILK 1.5
⚙ 7210762	11 x 25 mm SOFTSILK 1.5
⚙ 7210764	12 x 25 mm SOFTSILK 1.5
⚙ 7210767	12 x 40 mm SOFTSILK 1.5
⚙ 7210745	13 x 25 mm SOFTSILK 1.5
⚙ 7210746	13 x 30 mm SOFTSILK 1.5
⚙ 7210747	13 x 35 mm SOFTSILK 1.5
⚙ 7210748	13 x 40 mm SOFTSILK 1.5

## ACL/PCL Fixation Systems

### SOFTSILK<sup>®</sup> Screw Systems



#### SOFTSILK 2.0 Screw System

Reference #	Description
7207154	SOFTSILK 2.0 Screw System Sterile screws (3 of each size included with system)

#### System includes

7207256	7 x 20 mm SOFTSILK 2.0
7207257	7 x 25 mm SOFTSILK 2.0
7207258	7 x 30 mm SOFTSILK 2.0
7207259	8 x 20 mm SOFTSILK 2.0
7207260	8 x 25 mm SOFTSILK 2.0
7207261	8 x 30 mm SOFTSILK 2.0
7207262	9 x 20 mm SOFTSILK 2.0
7207263	9 x 25 mm SOFTSILK 2.0
7207264	9 x 30 mm SOFTSILK 2.0
72202428	Instrument Tray
7207268	3.5 mm Hex Driver, 2.0 mm cannulation
7205658	CANNU-FLEX <sup>®</sup> Screw Guide Wire, 2 mm x 12" (30 cm) (6 per package)

#### Optional

⚙️ 7207705	Driver, 2 mm cannulation, 3.5 hex, with Hudson dapter (requires REF 7207707 Ratcheting Handle with Hudson Adapter)
------------	---

#### SOFTSILK 2.0 Fixation Screws

Titanium, 2 mm cannulation, round head, corkscrew tip, soft threads, sterile.



Reference # Screw only	Reference # Sheathed in CLEAR-TRAC <sup>®</sup> Screw Cannula; latex-free	Reference # Sheathed in CLEAR-TRAC Screw Cannula; contains latex	Description
7207256	7205649	7210140	7 x 20 mm SOFTSILK 2.0
7207257	7205650	7210141	7 x 25 mm SOFTSILK 2.0
7207258	7205651	7210142	7 x 30 mm SOFTSILK 2.0
7207259	7205652	7210143	8 x 20 mm SOFTSILK 2.0
7207260	7205653	7210144	8 x 25 mm SOFTSILK 2.0
7207261	7205654	7210145	8 x 30 mm SOFTSILK 2.0
7207262	7205655	7210146	9 x 20 mm SOFTSILK 2.0
7207263	7205656	7210147	9 x 25 mm SOFTSILK 2.0
7207264	7205657	7210148	9 x 30 mm SOFTSILK 2.0

## ACL/PCL Fixation Systems

### SOFTSILK<sup>®</sup> Screw Systems



#### CLEAR-TRAC<sup>®</sup> Screw Cannulas

Provides graft protection and aids screw delivery during graft fixation. Sterile, single use.

Reference #	Description
7207227	7 mm CLEAR-TRAC Screw Cannula, latex-free (10 per box)
7207228	8 mm CLEAR-TRAC Screw Cannula, latex-free (10 per box)
7207229	9 mm CLEAR-TRAC Screw Cannula, latex-free (10 per box)
7210118*	7 mm CLEAR-TRAC Screw Cannula, contains latex (10 per box)
7210119	8 mm CLEAR-TRAC Screw Cannula, contains latex (10 per box)
7210120	9 mm CLEAR-TRAC Screw Cannula, contains latex (10 per box)

#### CANNU-FLEX<sup>®</sup> SILK 1.0 Screws – Uses 1.0 mm CANNU-FLEX Guide Wire

Reference # Sterile	Reference # Screwdriver	Description
014206	014270	6 mm x 20 mm
014207	014270	6 mm x 25 mm
014208	014270	6 mm x 30 mm
014200	014270	7 mm x 20 mm
014201	014270	7 mm x 25 mm
014202	014270	7 mm x 30 mm
014813	014270	8 mm x 20 mm
014814	014270	8 mm x 25 mm
014203	014271	9 mm x 20 mm
014204	014271	9 mm x 25 mm
014205	014271	9 mm x 30 mm

#### Fluid seals

Reference #	Description
⚙️ 7205122	Fluid seals for 7 mm, 8 mm, 9 mm and 10 mm cannulas, non-sterile, autoclavable (25 per package)

\* Item shown

⚙️ Special, Made to Order products are available to meet the individual needs of surgeons. Please appreciate that longer lead time for delivery should be expected. For more information, please contact your sales representative or Customer Service.

## ACL/PCL Fixation Systems

### TRAILBLAZER<sup>®</sup> Wire Guides, Screw Guides and Screw Guide Wires



#### TRAILBLAZER Wire Guide

Provides delivery of the CANNU-FLEX<sup>®</sup> Screw Guide Wire while creating a de-rotational slot for the screw.

Reference #	Description
014417	TRAILBLAZER, 1 mm cannulation
014851	TRAILBLAZER, 1.5 mm cannulation

#### Screw Guides

Compatible with CANNU-FLEX SILK 1.0 and ACUFEX<sup>®</sup> Non-Cannulated Interference Screws.



Reference #	Description
014662*	7 mm, SILK ESCORT <sup>®</sup>
014816	9 mm, SILK ESCORT

#### Screw Guide Wires

Single use, includes 20 mm, 25 mm, and 30 mm calibration marks to assist in screw placement (6 per package).



Reference #	Description
014394	CANNU-FLEX Screw Guide Wires, 1 mm x 12" (30 cm), Nitinol, blunt tip, sterile
72202873	CANNU-FLEX Screw Guide Wires, 1 mm x 12" (30 cm), Nitinol, blunt tip, sterile
013443	Stainless Steel Guide Wires, 1 mm x 12" (30 cm), trocar tip, non-sterile
013475	CANNU-FLEX Screw Guide Wires, 1 mm x 9" (23 cm), Nitinol, trocar tip, non-sterile
014859	CANNU-FLEX Screw Guide Wire, 1.5 mm x 12" (30 cm), blunt tip, sterile
014545	CANNU-FLEX Screw Guide Wire, 1.5 mm x 12" (30 cm), blunt tip, non-sterile
72202810	CANNU-FLEX Screw Guide Wire, 1.5 mm x 9" (23 cm), blunt tip, sterile
72202881	Stainless Steel Guide Wires, 2 mm x 9" (23 cm), blunt tip, sterile
7205658	CANNU-FLEX Screw Guide Wire, 2 mm x 12" (30 cm), blunt tip, non-sterile
7205659	CANNU-FLEX Screw Guide Wire, 2 mm x 12" (30 cm), blunt tip, sterile
7207222	CANNU-FLEX Screw Guide Wire, 2 mm x 15" (38 cm), blunt tip, sterile

\* Item shown



## ACL/PCL Fixation Systems

### Spiked Washer/Tibial Anchor

#### Spiked Washer/Tibial Anchor

The Smith & Nephew ACUFEX® Spiked Washer/Tibial Anchor is an implant system specifically designed for securing soft tissue tendons to cortical bone. Its primary function is for securing a doubled, looped Semi-T/Gracilis graft (DLSTG) onto the tibial cortex.



Reference #	Description
7207725*	Spiked Washer, 17 mm, sterile Designed for use with Tibial Anchor REF 7207186
7207726*	Spiked Washer, 21 mm, sterile
7208717	Suture Washer, 14 mm, sterile
3134281	Suture Washer (US only)



Reference #	Description
7208681*	Stabilizer Wrench

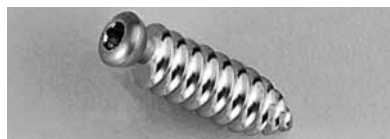

Reference #	Description
7207186*	Tibial Anchor, 9 x 25 mm, sterile Designed for use in conjunction with REF 7207725. Requires Tibial Anchor Driver REF 014924.



Reference #	Description
014925*	Tibial Anchor, 4.5 mm, Drill Bit Built in depth stop is designed to be used with the Tibial Anchor Drill Guide REF 014927. The 25 mm depth calibration also allows it to be used without the guide.
3134135	Tibial Anchor, 5.5 mm, Drill For use in hard bone without the Tibial Anchor Drill Guide.



Reference #	Description
014927*	Tibial Anchor Drill Guide Quickly and accurately produces a 25 mm deep perpendicular hole when used with the Tibial Anchor Drill Bit REF 014925. For use in hard bone without the Tibial Anchor Drill Guide.



Reference #	Description
014924*	Tibial Anchor, 3.5 mm, Hex Driver Unique hex design assures secure engagement into both portions of the Tibial Anchor REF 7207186.



Reference #	Description
011703*	Small Sterilization Tray

\* Item shown

⚙️ Special, Made to Order products are available to meet the individual needs of surgeons. Please appreciate that longer lead time for delivery should be expected. For more information, please contact your sales representative or Customer Service.

## ACL/PCL Fixation Systems

### Fixation Posts



#### Fixation Post System

Flat head design eliminates need for washer when tying sutures around a post.  
Low profile design improves patient comfort.

Reference #	Description
-------------	-------------

014465	Fixation Post System
--------	----------------------

#### System includes

013124	Fixation Post Driver with Holder, 3 mm Hex
--------	--

013177	Fixation Post Tap
--------	-------------------

⚙️ 013479Z	Fixation Post Depth Gauge
------------	---------------------------

011804	Sterilization Tray for Fixation Post System
--------	---

014695	2.4 mm Drill, disposable
--------	--------------------------

#### Fixation Posts – Sterile

##### Titanium suture post



Reference #	Description
-------------	-------------

013140*	4.5 mm x 25 mm
---------	----------------

013141	4.5 mm x 30 mm
--------	----------------

013142	4.5 mm x 35 mm
--------	----------------

013143	4.5 mm x 40 mm
--------	----------------

013144	4.5 mm x 45 mm
--------	----------------

013145	4.5 mm x 50 mm
--------	----------------

013146	4.5 mm x 55 mm
--------	----------------

## ACL/PCL Fixation Systems

### Suture Fixation

#### DOUBLE-SPIKED PLATE Tibial Fixation System

Low profile DOUBLE-SPIKED PLATE Tibial Fixation System provides surgeons the ability to independently tension the graft prior to final fixation.



Reference #	Description
72201861	DOUBLE-SPIKED PLATE, large
72201862	Fixation Post, DSP 6.5 mm x 25 mm
72201863	Fixation Post, DSP 6.5 mm x 30 mm
72201864	Fixation Post, DSP 6.5 mm x 35 mm
72201865	Fixation Post, DSP 6.5 mm x 40 mm
72202232	DOUBLE-SPIKED PLATE, small
72202233	Fixation Post, DSP 5 mm x 25 mm
72202234	Fixation Post, DSP 5 mm x 30 mm
72202235	Fixation Post, DSP 5 mm x 35 mm
72202236	Fixation Post, DSP 5 mm x 40 mm

#### Instrumentation

72202225	3.3 mm Drill
72202226	3.3 mm Drill Guide
72202311	Large Inserter DSP
72202230	3 mm Drill
72202231	3 mm Drill Guide
72202312	Small Inserter DSP
014924	3.5 Hex ACUFEX® Spiked washer driver
72202326	Handle, Tensioning device
011703	Small sterilization tray with mat

#### Suture Washers

Titanium button for fixating grafts with sutures, non-sterile



Reference #	Description
7204791	15 mm Suture Washer
7204792	17 mm Suture Washer

#### Fixation Buttons

Delrin button for fixating grafts with sutures, sterile



Reference #	Description
013635	14 mm Fixation Buttons (6 per box)
013636	17 mm Fixation Buttons (6 per box)

## ACL/PCL Fixation Systems

### Graft Sleeve and Tissue Cinch



GTS Sleeve

Reference #	Description
7210038	GTS Sleeve
7210039	GTS 7 mm x 30 mm Tapered Screw
7210040	GTS 8 mm x 30 mm Tapered Screw
7208656	GTS Screw Driver

NOTE: GTS Instruments listed on page A-29



WHIPKNOT Soft Tissue Cinch

The WHIPKNOT Soft Tissue Cinch is indicated for use in assisting in the harvest, preparation, and placement of soft tissue grafts during ligament reconstructive surgical procedures. Packaged pre-assembled in a sterile pack that includes a disposable cannula.

Reference #	Description
7211015	WHIPKNOT, #5 Soft Tissue Cinch, sterile (1 per box)

## ACL/PCL Fixation Systems

### Graft Harvesting Instruments

#### Tendon Strippers

Used for semitendinosus and gracilis graft harvesting.

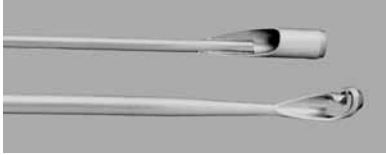

Reference #	Description
7207179	Large Tendon Stripper, closed, 7.4 mm I.D. x 13.5" working length
013550*	Tendon Stripper, closed, 6.4 mm I.D. x 12" working length
013554*	Tendon Stripper, slotted, 5 mm I.D. x 12" working length

#### Patellar Tendon Saw Guides

Sized guides for marking and harvesting patellar tendons for cruciate reconstruction.



Reference #	Description
7205637	9 mm Saw Guide
7205638*	10 mm Saw Guide
7205639	11 mm Saw Guide

#### COMPACTION Pliers

Helps shape the bone-tendon-bone grafts used in ACL/PCL reconstruction. The actual size of the COMPACTION Pliers is .75 mm smaller than the stated size. This permits easy insertion of the graft into the femoral tunnel and allows for bone memory.



Reference #	Description
7209441	7 mm COMPACTION Pliers
7209442	8 mm COMPACTION Pliers
7209443	9 mm COMPACTION Pliers
7209446	10 mm COMPACTION Pliers
7209447	11 mm COMPACTION Pliers
7209448	12 mm COMPACTION Pliers

## Graft Harvesting/Preparation

### GRAFTMASTER® III and GTS Preparation System



#### GRAFTMASTER III System Instruments for graft preparation

Reference #	Description
72202788	GRAFTMASTER III System

#### System includes

72202452	GRAFTMASTER III Preparation board
72202316	GRAFTMASTER III Sliding base (2)
72202315	GRAFTMASTER III Tissue grasper (2)
72202317	GRAFTMASTER III Cutting strip
72202453	GRAFTMASTER III BTB Holder
72202319	GRAFTMASTER III Slotted Sizing block
72202441	GRAFTMASTER III System Tray
014415	ENDOBUTTON® Holder
014413	Suture Vise

#### Additional components

7209951	ENDOBUTTON Adjustable Knob for Depth Probe
015185	ENDOBUTTON Depth Probe
3134301	Cannulated Depth Probe

#### GTS Preparation System

The Smith & Nephew GTS System offers technologically advanced instruments to assist surgeons during ACL reconstruction procedures. More than just a means of simplifying the technique, this system is able to effectively anchor and compress soft tissue grafts, giving surgeons the confidence of a strong, accurate fixation.

Reference #	Description
7209926	Graft Tensioning Device
7209862	Tensioning Device Holder
7209721	ENDOBUTTON Holder Scale Extender

## Graft Harvesting/Preparation

### GRAFTMASTER® III and GTS Preparation System

#### Optional Components



Reference #	Description
014414	GRAFTMASTER® III Suture Vise with Tensiometer, allows the pre-tensioning of grafts
357280	GRAFTMASTER® III Replacement shoulder screw
40000202	GRAFTMASTER® III Replacement small flat headed screw



Reference #	Description
72202315	GRAFTMASTER® III Tissue Grasper (4 recommended)



Reference #	Description
7207342	GRAFTMASTER® III Tensioning Post Ideal for pretensioning grafts when using the ENDOBUTTON® CL



Reference #	Description
72202317	GRAFTMASTER III Cutting Strip, for use on all GRAFTMASTER III Boards
72201212	GRAFTMASTER® III ENDOBUTTON DIRECT Holder
72201600	GRAFTMASTER® III ENDOBUTTON Direct Scale

#### GRAFTMASTER II System Replacement Parts

Reference #	Description
014953	Replacement GRAFTMASTER II Cutting Strip
7207692	Replacement GRAFTMASTER II Full Length Cutting Strip
014412	Replacement GRAFTMASTER II Tissue Grasper

## ACL/PCL Reconstruction Drill Guide System

### CLANCY™ Anatomic Cruciate Guide/Flexible Drill System



The CLANCY Anatomic Cruciate Guide/Flexible Drill System reproduces more accurate anatomic femoral tunnel placements without hyperflexing the knee and utilizes the anterior medial portal.

Reference #	Description	Reference #	Description
72203086*	CLANCY Anatomic Cruciate Guide Flexible Drill System A	72203087*	CLANCY Anatomic Cruciate Guide Flexible Drill System B
<b>System includes</b>		<b>System includes</b>	
72202971	4.5 mm CLANCY Flexible Drill	72202971	4.5 mm CLANCY Flexible Drill
72202972	5.5 mm CLANCY Flexible Drill	72202972	5 mm CLANCY Flexible Drill
72203161	5.5 mm CLANCY Flexible Drill	72203161	5.5 mm CLANCY Flexible Drill
72202594	6 mm CLANCY Flexible Drill	72202594	6 mm CLANCY Flexible Drill
72203162	6.5 mm CLANCY Flexible Drill	72203162	6.5 mm CLANCY Flexible Drill
7209008	7 mm CLANCY Flexible Drill	7209008	7 mm CLANCY Flexible Drill
72203163	7.5 mm CLANCY Flexible Drill	72203163	7.5 mm CLANCY Flexible Drill
7209737	8 mm CLANCY Flexible Drill	7209737	8 mm CLANCY Flexible Drill
72203164	8.5 mm CLANCY Flexible Drill	72203164	8.5 mm CLANCY Flexible Drill
7209738	9 mm CLANCY Flexible Drill	7209738	9 mm CLANCY Flexible Drill
72203165	9.5 mm CLANCY Flexible Drill	72203165	9.5 mm CLANCY Flexible Drill
7209739	10 mm CLANCY Flexible Drill	7209739	10 mm CLANCY Flexible Drill
72203166	10.5 mm CLANCY Flexible Drill	72203166	10.5 mm CLANCY Flexible Drill
72203090	11 mm CLANCY Flexible Drill	72203090	11 mm CLANCY Flexible Drill
72203167	11.5 mm CLANCY Flexible Drill	72203167	11.5 mm CLANCY Flexible Drill
72203091	12 mm CLANCY Flexible Drill	72203091	12 mm CLANCY Flexible Drill
72203170	CLANCY Curved Femoral Guide, 42°	72203170	CLANCY Curved Femoral Guide, 42°
72203168*	BIOSURE Flexible Driver		
7207707	Ratcheting Handle with Hudson Adapter	<b>Accessories</b>	
72203252*	6 mm BIOSURE Flexible Tap	72201594	2.4 mm Flexible Passing Pins, sterile (5 per package)
72203253*	7 mm BIOSURE Flexible Tap		
72203254*	8 mm BIOSURE Flexible Tap		
72203255*	9 mm BIOSURE Flexible Tap		
72203256*	10 mm BIOSURE Flexible Tap		
72203085*	CLANCY Instrument Tray System		

\* Product availability is subject to change.  
For more information, please contact your sales representative or Customer Service.



## ACL/PCL Reconstruction Drill Guide System

### ACUFEX<sup>®</sup> PINPOINT Anatomic ACL Guide System

The ACUFEX PINPOINT Anatomic ACL Guide System is versatile and easy-to-use. The system enables visualization of the size and placement of femoral tunnel(s) in the native anatomic location. The system is meant to help the transition from trans-tibial to medial portal drilling.

- Facilitates accurate tunnel placement without the need for bony landmarks
- Determines position of AM and PL bundles
- Complete system accommodates both single- and double-bundle reconstructions
- Addresses different technique preferences for drilling, including inside-out and outside-in
- Features multiple sizes to help cover the native footprint

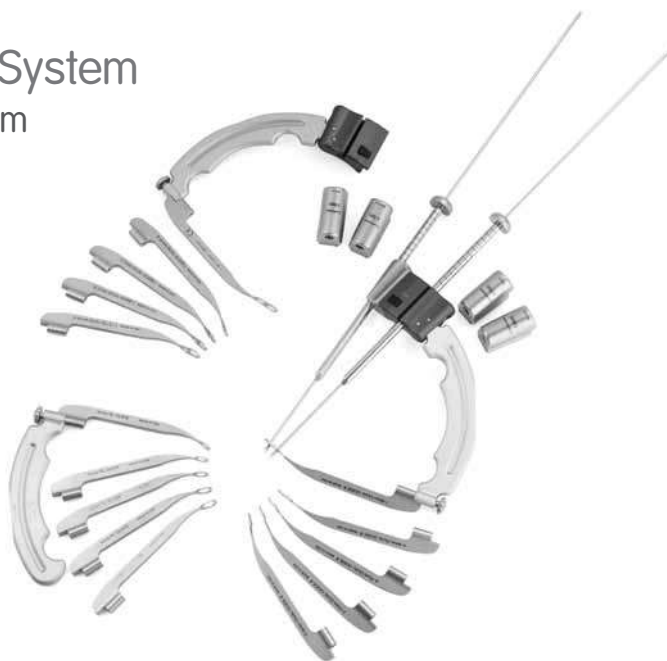

Reference #	Description
72203454	ACUFEX PINPOINT Anatomic ACL Guide System

#### System includes

72203433	6 mm Single-bundle Guide
72203434	7 mm Single-bundle Guide
72203435	8 mm Single-bundle Guide
72203436	9 mm Single-bundle Guide
72203437	10 mm Single-bundle Guide
72203438	5-6 mm Double-bundle Guide, Left
72203439	5-7 mm Double-bundle Guide, Left
72203440	6-7 mm Double-bundle Guide, Left
72203441	6-8 mm Double-bundle Guide, Left
72203442	7-8 mm Double-bundle Guide, Left
72203443	5-6 mm Double-bundle Guide, Right
72203444	5-7 mm Double-bundle Guide, Right
72203445	6-7 mm Double-bundle Guide, Right
72203446	6-8 mm Double-bundle Guide, Right
72203447	7-8 mm Double-bundle Guide, Right
72203425	Outside-in Aimer Arm, Left
72203426	Outside-in Aimer Arm, Right
72203432	Inside-out Handle
72203427	5-6 mm Double-bundle Bullet Support
72203428	5-7 mm Double-bundle Bullet Support
72203429	6-7 mm Double-bundle Bullet Support
72203430	6-8 mm Double-bundle Bullet Support
72203431	7-8 mm Double-bundle Bullet Support
72203448	System Sterilization Tray
72203453	ACUFEX Insertion Site Marking Awl, 45°
72203450	4-point Bullet, 6.5"

Reference #	Description
72203452	ACUFEX PINPOINT Anatomic ACL Single-bundle Guide System

#### System includes

72203433	6 mm Single-bundle Guide
72203434	7 mm Single-bundle Guide
72203435	8 mm Single-bundle Guide
72203436	9 mm Single-bundle Guide
72203437	10 mm Single-bundle Guide
72203425	Outside-in Aimer Arm, Left
72203426	Outside-in Aimer Arm, Right
72203432	Inside-out Handle
72203451	Single-bundle System Sterilization Tray
72203453	ACUFEX Insertion Site Marking Awl, 45°
72203450	4-point Bullet, 6.5"

## ACL/PCL Reconstruction Drill Guide System

### ACUFEX<sup>®</sup> Anatomic ACL Guide System

#### ACUFEX Anatomic ACL Guide System

ACUFEX Anatomic ACL Guide System for double bundle ACL reconstruction lets you restore the anatomic footprints of the AM and PL bundles. You can drill independent and diverging bone tunnels on the femoral and tibial side of the knee joint with consistent, reproducible separation.

Reference #	Description
72202423	ACUFEX DIRECTOR ELITE Anatomic ACL Guide System

#### System includes

72201240	PL Femoral Aimer Handle
72201974	5 mm PL Femoral Aimer Post
72201975	5.5 mm PL Femoral Aimer Post
72201241	6 mm PL Femoral Aimer Post
72201976	6.5 mm PL Femoral Aimer Post
72201242	7 mm PL Femoral Aimer Post
72201977	7.5 mm PL Femoral Aimer Post
72201243	8 mm PL Femoral Aimer Post
72201978	8.5 mm PL Femoral Aimer Post
72201244	9 mm PL Femoral Aimer Post
72201245	PL Tibial Aimer Handle, Left
72201246	PL Tibial Aimer Handle, Right
72201969	5 mm PL Tibial Aimer Post
72201970	5.5 mm PL Tibial Aimer Post
72201247	6 mm PL Tibial Aimer Post
72201971	6.5 mm PL Tibial Aimer Post
72201248	7 mm PL Tibial Aimer Post
72201972	7.5 mm PL Tibial Aimer Post
72201249	8 mm PL Tibial Aimer Post
72201973	8.5 mm PL Tibial Aimer Post
72201250	9 mm PL Tibial Aimer Post
6900854	Non-cannulated Drill Bit, 4.5 mm
72202437	Anatomic ACL Double Bundle Instrument Tray
72202547	Locking Wrench



Reference #	Description
72201252	ACUFEX DIRECTOR Anatomic ACL Guide System

#### System includes

72201240	PL Femoral Aimer Handle
72201241	6 mm PL Femoral Aimer Post
72201242	7 mm PL Femoral Aimer Post
72201241	6 mm PL Femoral Aimer Post
72201243	8 mm PL Femoral Aimer Post
72201244	9 mm PL Femoral Aimer Post
72201245	PL Tibial Aimer Handle, Left
72201246	PL Tibial Aimer Handle, Right
72201247	6 mm PL Tibial Aimer Post
72201248	7 mm PL Tibial Aimer Post
72201249	8 mm PL Tibial Aimer Post
72201250	9 mm PL Tibial Aimer Post
6900854	Non-cannulated Drill Bit, 4.5 mm
72202437	Anatomic ACL Double Bundle Instrument Tray

## ACL/PCL Reconstruction Drill Guide System

### ACUFEX<sup>®</sup> DIRECTOR ACL System Sets

The Smith & Nephew ACUFEX DIRECTOR ELITE Drill Guide System is a complete system of instruments for the accurate, reproducible placement and drilling of tibial and femoral tunnels during single-incision ACL reconstruction. The system components are sized for both bone-tendon-bone and soft tissue grafts.

#### ACUFEX DIRECTOR ELITE Drill Guide System

Reference #	Description
72201746	ACUFEX DIRECTOR ELITE ACL Drill Guide System

#### System includes

7205517	ACUFEX DIRECTOR Drill Guide Requires: 1 Aimer and 1 Bullet (not included, see pg. A-42 and A-43)
7205518	ACUFEX DIRECTOR ACL Elbow Aimer
7205519	ACUFEX DIRECTOR ACL Tip Aimer
7205524	ACUFEX DIRECTOR Angled Bullet
7205525	ACUFEX DIRECTOR 4-Point Bullet
013498	5 mm Cannulated Drill
7207491	5.5 mm Cannulated Drill
013542	6 mm Cannulated Drill
7207483	6.5 mm Cannulated Drill
013543	7 mm Cannulated Drill
7207484	7.5 mm Cannulated Drill
013544	8 mm Cannulated Drill
7207485	8.5 mm Cannulated Drill
013545	9 mm Cannulated Drill
013546	10 mm Cannulated Drill
013547	11 mm Cannulated Drill
013548	12 mm Cannulated Drill
7208686	5 mm Endoscopic Drill
7207482	5.5 mm Endoscopic Drill
013499	6 mm Endoscopic Drill
7207492	6.5 mm Endoscopic Drill
013660	7 mm Endoscopic Drill
7207493	7.5 mm Endoscopic Drill
013661	8 mm Endoscopic Drill
7207494	8.5 mm Endoscopic Drill
013662	9 mm Endoscopic Drill
013663	10 mm Endoscopic Drill
013664	11 mm Endoscopic Drill
013665	12 mm Endoscopic Drill

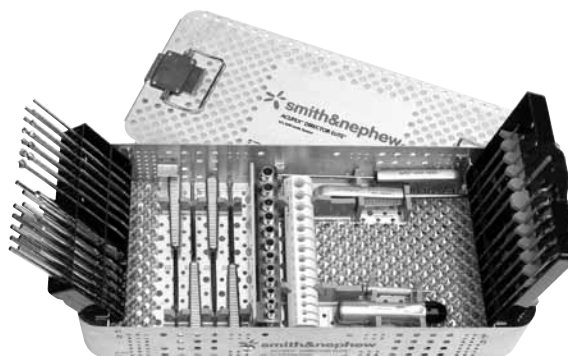

Reference #	Description
72201732	Universal EndoFemoral Aimer Handle
72201737	EndoFemoral Aimer, no offset
72201713	3 mm Offset EndoFemoral Aimer
72201714	4 mm Offset EndoFemoral Aimer
72201715	5 mm Offset EndoFemoral Aimer
72201716	6 mm Offset EndoFemoral Aimer
72201717	7 mm Offset EndoFemoral Aimer
7205521	2–5 mm Offset Guide
7205622	NOTCHMASTER <sup>®</sup> 8.0 mm Curette
7209214	Slotted sizing block
72201731	Sterilization Tray for ACUFEX DIRECTOR ELITE ACL Drill Guide System

#### Optional Accessories

013522	6 mm Graft Sizing Tube
013523	7 mm Graft Sizing Tube
013524	8 mm Graft Sizing Tube
013525	9 mm Graft Sizing Tube
013526	10 mm Graft Sizing Tube
013527	11 mm Graft Sizing Tube
013528	12 mm Graft Sizing Tube
72201735	5–6 mm bone tunnel plug
72201733	5 mm half-round rasp
72201734	6 mm half-round rasp
72201883	Chondral pick, small, 20°
72201884	Chondral pick, large, 20°
72201885	Chondral pick, small, 40°
72201886	Chondral pick, large, 40°
72201736	Chondral pick, small, 90°

## ACL/PCL Reconstruction Drill Guide System

### ACUFEX<sup>®</sup> DIRECTOR ACL System Sets

The Smith & Nephew ACUFEX DIRECTOR ELITE Soft Tissue Drill Guide System is a complete system of instruments for the accurate, reproducible placement and drilling of tibial and femoral tunnels during single-incision ACL reconstruction. The system components are sized for soft tissue grafts using single- or double-tunnel techniques.

#### ACUFEX DIRECTOR ELITE Soft Tissue Drill Guide System

Reference #	Description
72201965	ACUFEX DIRECTOR ELITE Soft Tissue Drill Guide System

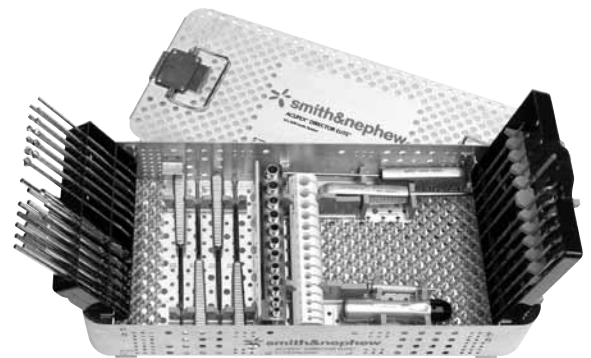

#### System includes

7205517	ACUFEX DIRECTOR Drill Guide Requires: 1 Aimer and 1 Bullet (not included, see pg. A-42 and A-43)
	7205518 ACUFEX DIRECTOR ACL Elbow Aimer
	7205519 ACUFEX DIRECTOR ACL Tip Aimer
	7205524 ACUFEX DIRECTOR Angled Bullet
	7205525 ACUFEX DIRECTOR 4-point Bullet
013498	5 mm Cannulated Drill
7207491	5.5 mm Cannulated Drill
013542	6 mm Cannulated Drill
7207483	6.5 mm Cannulated Drill
013543	7 mm Cannulated Drill
7207484	7.5 mm Cannulated Drill
013544	8 mm Cannulated Drill
7207485	8.5 mm Cannulated Drill
013545	9 mm Cannulated Drill
7208686	5 mm Endoscopic Drill
7207482	5.5 mm Endoscopic Drill
013499	6 mm Endoscopic Drill
7207492	6.5 mm Endoscopic Drill
013660	7 mm Endoscopic Drill
7207493	7.5 mm Endoscopic Drill
013661	8 mm Endoscopic Drill
7207494	8.5 mm Endoscopic Drill
013662	9 mm Endoscopic Drill

Reference #	Description
72201732	Universal EndoFemoral Aimer Handle
72201737	EndoFemoral Aimer, no offset
72201713	3 mm Offset EndoFemoral Aimer
72071714	4 mm Offset EndoFemoral Aimer
72071715	5 mm Offset EndoFemoral Aimer
7205521	2–5 mm Offset Guide
7205622	NOTCHMASTER <sup>®</sup> 8 mm Curette
7209214	Slotted sizing block
72201731	Sterilization Tray for ACUFEX DIRECTOR ELITE ACL Drill Guide System

## ACL/PCL Reconstruction Drill Guide System

### ACUFEX<sup>®</sup> DIRECTOR ACL System Sets

The Smith & Nephew ACUFEX DIRECTOR ELITE RCI Drill Guide System is a complete system of instruments for the accurate, reproducible placement and drilling of tibial and femoral tunnels during ACL reconstruction using the RCI technique. The routers are specifically designed to compress the drilled bone into the tunnel walls, creating a firm fixation environment.

#### ACUFEX DIRECTOR ELITE RCI Drill Guide System

Reference #	Description
72201966	ACUFEX DIRECTOR ELITE RCI Drill Guide System

#### System includes

7205517	ACUFEX DIRECTOR Drill Guide Requires: 1 Aimer and 1 Bullet (not included, see pg. A-42 and A-43)
7205518	ACUFEX DIRECTOR ACL Elbow Aimer
7205519	ACUFEX DIRECTOR ACL Tip Aimer
7205524	ACUFEX DIRECTOR Angled Bullet
7205525	ACUFEX DIRECTOR 4-point Bullet
7207167	6.5 mm RCI Tibial Stepped Router
7207168	7 mm RCI Tibial Stepped Router
7207171	7.5 mm RCI Tibial Stepped Router
7207172	8 mm RCI Tibial Stepped Router
7207173	8.5 mm RCI Tibial Stepped Router
7207174	6.5 mm RCI Femoral Stepped Router
7207175	7 mm RCI Femoral Stepped Router
7207176	7.5 mm RCI Femoral Stepped Router
7207177	8 mm RCI Femoral Stepped Router
7207178	8.5 mm RCI Femoral Stepped Router
72201732	Universal EndoFemoral Aimer Handle
72201737	EndoFemoral Aimer, no Offset
72201713	3 mm Offset EndoFemoral Aimer
72201714	4 mm Offset EndoFemoral Aimer
72201715	5 mm Offset EndoFemoral Aimer
7205521	2–5 mm Offset Guide
7205622	NOTCHMASTER <sup>®</sup> 8 mm Curette
7209214	Slotted sizing block
72201731	Sterilization Tray for ACUFEX DIRECTOR ELITE ACL Drill Guide System

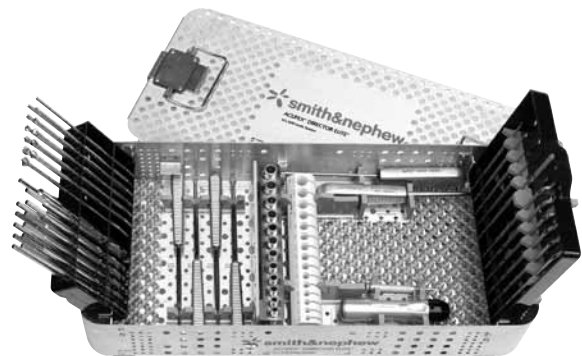

## ACL/PCL Reconstruction Drill Guide System

### ACUFEX<sup>®</sup> DIRECTOR ACL System Sets

The Smith & Nephew ACUFEX DIRECTOR ELITE Bone-Tendon-Bone Drill Guide System is a complete system of instruments for the accurate, reproducible placement and drilling of tibial and femoral tunnels during ACL reconstruction. The system components are sized for the use of bone-tendon-bone grafts.

#### ACUFEX DIRECTOR ELITE Bone-Tendon-Bone ACL Drill Guide System

Reference #	Description
72201967	ACUFEX DIRECTOR ELITE Bone-Tendon-Bone Drill Guide System

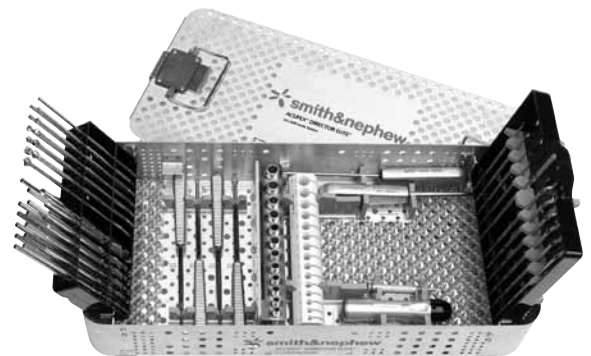

#### System includes

7205517	ACUFEX DIRECTOR Drill Guide Requires: 1 Aimer and 1 Bullet (not included, see pg. A-42 and A-43)
7205518	ACUFEX DIRECTOR ACL Elbow Aimer
7205519	ACUFEX DIRECTOR ACL Tip Aimer
7205524	ACUFEX DIRECTOR Angled Bullet
7205525	ACUFEX DIRECTOR 4-point Bullet
013544	8 mm Cannulated Drill
7207485	8.5 mm Cannulated Drill
013545	9 mm Cannulated Drill
013546	10 mm Cannulated Drill
013547	11 mm Cannulated Drill
013548	12 mm Cannulated Drill
013661	8 mm Endoscopic Drill
7207494	8.5 mm Endoscopic Drill
013662	9 mm Endoscopic Drill
013663	10 mm Endoscopic Drill
013664	11 mm Endoscopic Drill
013665	12 mm Endoscopic Drill
72201732	Universal EndoFemoral Aimer Handle
72201715	5 mm Offset EndoFemoral Aimer
72201716	6 mm Offset EndoFemoral Aimer
72201717	7 mm Offset EndoFemoral Aimer
7205521	2–5 mm Offset Guide
7205622	NOTCHMASTER <sup>®</sup> 8 mm Curette
7209214	Slotted sizing block
72201731	Sterilization Tray for ACUFEX DIRECTOR ELITE ACL Drill Guide System

## ACL/PCL Reconstruction Drill Guide System

### ACUFEX<sup>®</sup> DIRECTOR ACL System Sets

The Smith & Nephew ACUFEX DIRECTOR ELITE Rear Entry Drill Guide System is a complete system of instruments for the accurate, reproducible placement and drilling of tibial and femoral tunnels during ACL reconstruction. The system components are designed for a two-incision technique.

#### ACUFEX DIRECTOR ELITE Rear Entry Drill Guide System

Reference #	Description
72201968	ACUFEX DIRECTOR ELITE Rear Entry Drill Guide System

#### System includes

7205517	ACUFEX DIRECTOR Drill Guide Requires: 1 Aimer and 1 Bullet (not included, see pg. A-42 and A-43)
	7205518 ACUFEX DIRECTOR ACL Elbow Aimer
	7205519 ACUFEX DIRECTOR ACL Tip Aimer
	7205524 ACUFEX DIRECTOR Angled Bullet
	7205525 ACUFEX DIRECTOR 4-point Bullet
013644	Rear Entry Introducer
013643	Rear Entry Aimer, left (includes Tri-Point Bullet REF 013645)
013642	Rear Entry Aimer, right (includes Tri-Point Bullet REF 013645)
013498	5 mm Cannulated Drill
72077491	5.5 mm Cannulated Drill
013542	6 mm Cannulated Drill
7207483	6.5 mm Cannulated Drill
013543	7 mm Cannulated Drill
7207484	7.5 mm Cannulated Drill
013544	8 mm Cannulated Drill



Reference #	Description
7207485	8.5 mm Cannulated Drill
013545	9 mm Cannulated Drill
013546	10 mm Cannulated Drill
013547	11 mm Cannulated Drill
013548	12 mm Cannulated Drill
7205521	2–5 mm Offset Guide
7205622	NOTCHMASTER <sup>®</sup> 8 mm Curette
7209214	Slotted sizing block
72201731	Sterilization Tray for ACUFEX DIRECTOR ELITE ACL Drill Guide System
<b>Optional</b>	
014723*	7.9 mm ACUFEX SMOOTHER Crucial Tool, sterile (optional)
014724*	9.5 mm ACUFEX SMOOTHER Crucial Tool, sterile (optional)

\* Removes operative debris and leads graft into tunnels

## ACL/PCL Reconstruction Drill Guide Systems

### ACUFEX<sup>®</sup> DIRECTOR APPLICATION Anatomic Guide

Use of the ACUFEX DIRECTOR APPLICATION Anatomic Guide has been shown to result in more anatomic, more consistent cruciate ligament tunnel placement.<sup>1</sup> Through the use of fluoroscopy the guide allows surgeons to reproducibly define the geometric insertion points of the anteromedial and posterolateral bundles independently of the size and shape of the knee.<sup>1,2</sup>

#### Real-time visualization enables more anatomic accuracy

- Gain insight of the anatomy of the insertion site on femur and tibia
- Overcome skeletal variation among patients
- Evaluate anatomic accuracy of tunnel placement before, during and after a procedure
- Facilitate optimal patient outcomes<sup>1,2</sup>

#### Selectable overlay options support a variety of procedures

- Customizable femoral grid
- Single-bundle
- Double-bundle

#### ACUFEX<sup>®</sup> DIRECTOR APPLICATION Anatomic Guide

Reference #	Description
72203260	ACUFEX Director Application, Anatomic Guide System*

#### System includes

72203204	ACUFEX Director Application touchpanel, software and keyboard tray
72203203	Adjustable height rolling monitor stand



#### Technique Example

Customizable single-bundle ACL femoral grid overlay option - radiographic quadrant method adapted from Bernard and Hertel

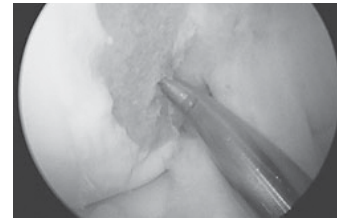

Mark intended femoral tunnel location with microfracture awl



Capture lateral x-ray image from C-arm



Use touchscreen or mouse to select the three key anatomic landmarks on the condyle e.g.

- Blumensaat's line – anterior
- Blumensaat's line – posterior
- Notch on condyle

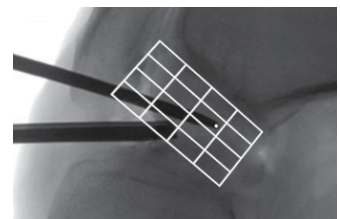

ACUFEX<sup>®</sup> DIRECTOR APPLICATION Anatomic Guide automatically generates overlay

<sup>1</sup> UPMC Cadaver Study (ongoing)

<sup>2</sup> Zantop T, et al. Tunnel positioning of anteromedial and posterolateral bundles in anatomic anterior cruciate ligament reconstruction: Anatomic and radiographic findings. The American Journal of Sports Medicine 2007. DOI: 10.1177/0363546507308361



# ACL/PCL Reconstruction Drill Guide System

## ACL Revision REDUX<sup>®</sup> System

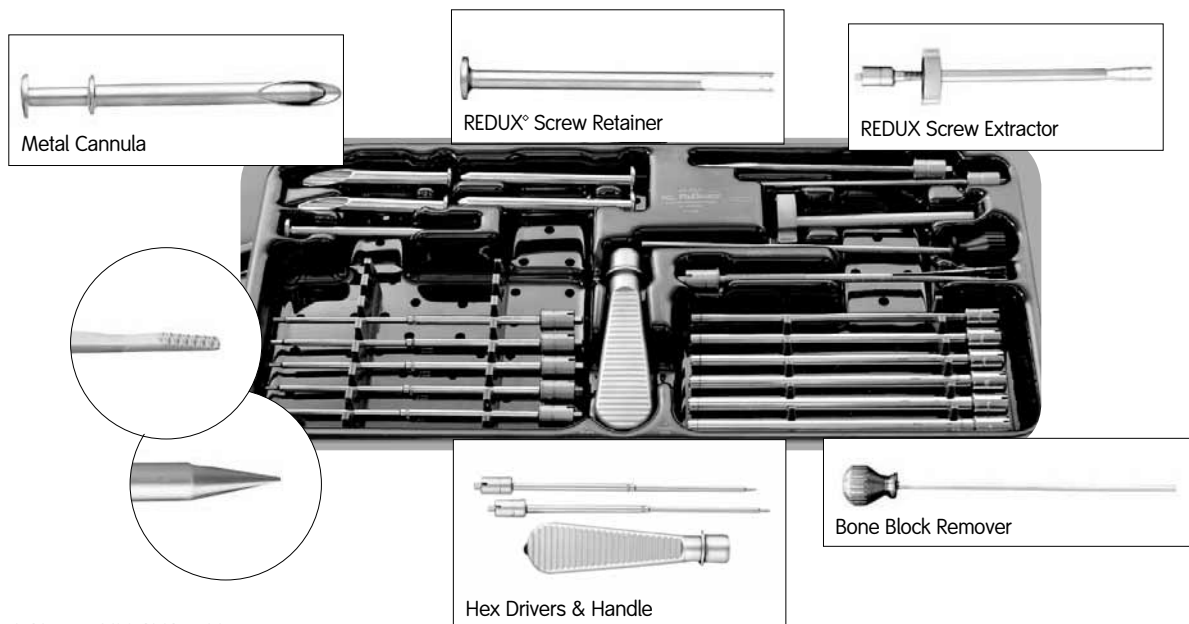

### ACL REDUX SYSTEM

The ACL REDUX System facilitates the removal of most leading manufacturers' interference screws from the knee during ACL revision surgery. The instrumentation addresses a wide variety of fixation techniques as well as the range of manufacturers' differences in screwdriver interface sizes.

Reference #	Description	Reference #	Description
014696	ACL REDUX System	<b>Included Disposables</b>	
<b>System includes</b>		014421	7 mm Trephine Drill
014621	REDUX Bone Pick	014422	8 mm Trephine Drill
014620	REDUX Rasp Pick	014423	9 mm Trephine Drill
014626	REDUX Screw Retainer	014424	10 mm Trephine Drill
014528	Universal Driver Handle	<b>Optional</b>	
014766	1.9 mm REDUX Driver	014432	Bone Block Remover
014767	2.3 mm REDUX Driver	<b>Optional Disposables</b>	
014768	2.4 mm REDUX Driver	014425	11 mm Trephine Drill
014769	2.7 mm REDUX Driver	014426	12 mm Trephine Drill
014770	3.4 mm REDUX Driver		
014598	9 mm REDUX Metal Cannula		
014599	9 mm REDUX Obturator		
014624	10 mm REDUX Metal Cannula		
014639	10 mm REDUX Obturator		
014627	REDUX Screw Extractor		
014870	Sterilization Tray for ACL REDUX System		

# ACL/PCL Reconstruction Drill Guide System

## ACL Revision REDUX<sup>°</sup> System Cross Reference Index

Interference Screws – REDUX Cross Reference Index

	Interference Screw	Screw Hex Size	Driver Tip Size	Corresponding REDUX Driver
<b>ACUFEX<sup>°</sup></b>	Interference 5.5 mm	2.0 mm	1.9 mm	014766
	Interference 7.0 mm	2.4 mm	2.3 mm	014767
	CANNU-FLEX <sup>°</sup> 7.0 mm	2.4 mm	2.3 mm	014767
	CANNU-FLEX SILK 1.0, 6.0–8.0 mm	2.8 mm	2.7 mm	014769
	CANNU-FLEX SILK 1.0, 9.0 mm	3.5 mm	3.4 mm	014770
	CANNU-FLEX SILK 1.5	3.5 mm	3.4 mm	014770
	Interference 9.0 mm	3.5 mm	3.4 mm	014770
	CANNU-FLEX 9.0 mm	3.5 mm	3.4 mm	014770
	SOFTSILK <sup>°</sup> 1.5 and 2.0	3.5 mm	3.4 mm	014770
	RCI	3.5 mm	3.4 mm	014770
<b>Arthrex<sup>™</sup></b>	6.0 mm	2.5 mm	2.4 mm	014768
	7.0 mm, 8.0 mm and 9.0 mm	3.5 mm	3.4 mm	014770
<b>DePuy<sup>™</sup></b>	5.5 mm	2.0 mm	1.9 mm	014766
	7.0 mm	2.5 mm	2.4 mm	014768
	9.0 mm	3.5 mm	3.4 mm	014770
<b>DYONICS<sup>°</sup></b>	SOFTLOC	3.5 mm	3.4 mm	014770
	Self-Guided Cannulated Screw	3.5 mm	3.4 mm	014770
	5.0–6.0 mm	2.5 mm	2.4 mm	014768
	7.0–9.0 mm	3.5 mm	3.4 mm	014770
<b>Linvatec<sup>™</sup></b>	5.75 mm	2.5 mm	2.4 mm	014768
	7.0 mm and 9.0 mm	3.5 mm	3.4 mm	014770

# ACL/PCL Reconstruction Drill Guide System

## HEALICORE<sup>®</sup> Trepine System



This efficient tibial tunnel reaming and coring system allows for the harvesting of tibial bone that is traditionally removed with standard reaming drills. It also provides the versatility to aid in backfilling during ACL and PCL reconstruction such as chondral lesion, patella tendon and quad-tendon donor sites.

Designed to accommodate a variety of arthroscopic ligament reconstruction techniques, the HEALICORE Trepine System compliments preferred repair and tibial fixation methods.

### HEALICORE Trepine System

Reference #	Description
72203642	HEALICORE Trepine System

#### System includes

##### Trepine Drill Adapters

72203065	6 mm
72203067	6.5 mm
72203069	7 mm
72203071	7.5 mm
72203073	8 mm
72203075	8.5 mm
72203077	9 mm
7220379	9.5 mm
72203081	10 mm
72203095	Plunger, 6 mm and 7 mm
72203096	Plunger, 8 mm, 9 mm and 10 mm
72203093	Compaction Pliers
72203316	Instrument Tray

##### Trepine K-wire Mandrels

72203064	6 mm
72203066	6.5 mm
72203068	7 mm
72203070	7.5 mm
72203072	8 mm
72203074	8.5 mm
72203076	9 mm
72203078	9.5 mm
72203080	10 mm

### HEALICORE Disposable, Single-use Trepines

Reference #	Description
72203058	6 mm Trepine Drill, sterile
72203059	6.5 mm Trepine Drill, sterile
72203244	7 mm Trepine Drill, sterile
72203060	7.5 mm Trepine Drill, sterile
72203245	8 mm Trepine Drill, sterile
72203061	8.5 mm Trepine Drill, sterile
72203246	9 mm Trepine Drill, sterile
72203062	9.5 mm Trepine Drill, sterile
72203247	10 mm Trepine Drill, sterile

## ACL/PCL Reconstruction Drill Guide System

### TRE-CORE Trephine System

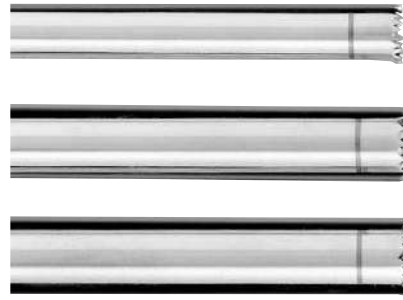
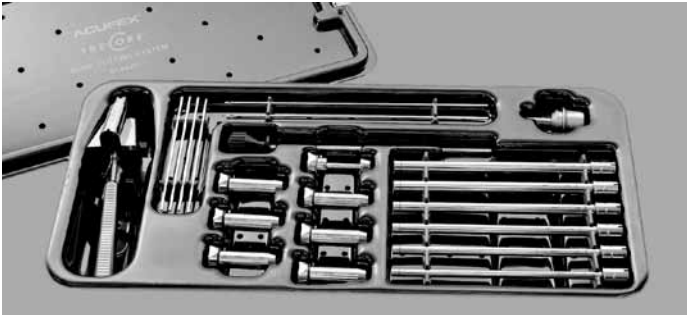

#### TRE-CORE Trephine System

The TRE-CORE Trephine Drill Guide System is an accurate drilling system that cores a bone tunnel during cruciate reconstruction, leaving a diameter-specific cancellous bone plug to fill defects from patellar, tibial, and femoral harvest sites.

Used in conjunction with ACL Guide Systems for bone tunnel coring and bone core harvesting.

Reference #	Description
014420	TRE-CORE Trephine Drill Guide System

#### System includes

014430	TRE-CORE Guide
014431	Quick Release Adapter
014432	Bone Block Remover
014439	2.4 mm Trephine Bullet
014433	7 mm Trephine Bullet
014434	8 mm Trephine Bullet
014435	9 mm Trephine Bullet
014436	10 mm Trephine Bullet
014437	11 mm Trephine Bullet
014438	12 mm Trephine Bullet
72202428	Instrument Tray

#### Disposables, single-use, non-sterile

014510	2.7 mm Locking Pins (6 per package)
013978	2.4 mm Drill-tip Guide Wires (6 per package)
014421	7 mm Trephine Drill
014422	8 mm Trephine Drill
014423	9 mm Trephine Drill
014424	10 mm Trephine Drill
014425	11 mm Trephine Drill
014426	12 mm Trephine Drill

#### Trephine Drills

Used with TRE-CORE (REF 014420) and REDUX<sup>®</sup> (REF 014696) Systems, 7" (17.75 cm) length, single use only.

Reference #	Description
014421	7 mm O.D. x 6.0 mm I.D.
014422	8 mm O.D. x 7.0 mm I.D.
014423	9 mm O.D. x 8.0 mm I.D.
014424	10 mm O.D. x 9.0 mm I.D.
014425	11 mm O.D. x 10 mm I.D.
014426	12 mm O.D. x 11 mm I.D.

## ACL/PCL Reconstruction Drill Guide System

### TUNDRA<sup>®</sup> PCL Aimer System

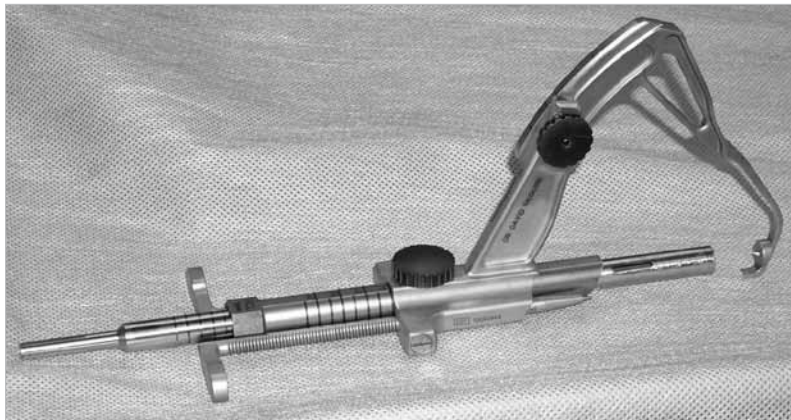

TUNDRA PCL Aimer System

Reference #	Description
72202405	TUNDRA PCL Aimer System

#### System includes

7210605	PCL Aimer Arm
7210606	Aimer Base Assembly
7210607	Outriggers
7210608	10 mm concentric PCL Bullet Assembly
7210609	11 mm concentric PCL Bullet Assembly
7210610	12 mm concentric PCL Bullet Assembly
7210618	9–10 mm Plunger
7210619	11–12 mm Plunger
7210629	10 mm Trepine Adapter
7210630	11 mm Trepine Adapter
7210631	12 mm Trepine Adapter
7210633	Sterilization Tray
7210637	10 mm Bullet Sleeve for 2.4 mm Guide Wire
7210638	11 mm Bullet Sleeve for 2.4 mm Guide Wire
7210639	12 mm Bullet Sleeve for 2.4 mm Guide Wire

#### Disposables, single-use, required

7210623	10 mm Trepine Drill, sterile
7210624	11 mm Trepine Drill, sterile
7210625	12 mm Trepine Drill, sterile

## ACL/PCL Reconstruction Drill Guide System

### ACUFEX<sup>®</sup> DIRECTOR PCL System

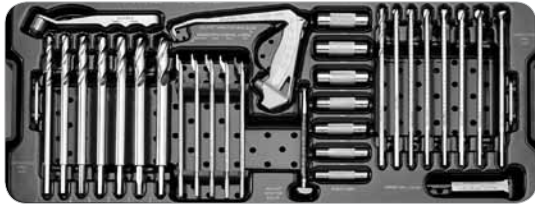

PCL Elevator/Wire Catcher



Femoral PCL Aimer



PCL Dilator (optional)



PCL Template (optional)



PCL Safety Stop



Tibial PCL Aimer



ACUFEX SMOOTHER (optional)

The Smith & Nephew ACUFEX DIRECTOR PCL components are designed as an integral part of the ACUFEX DIRECTOR Drill Guide System, providing tools that enable easy, accurate, and reproducible PCL reconstruction. For enhanced patient safety, this system includes the ACUFEX DIRECTOR PCL Safety Stop, which easily snaps onto the ACUFEX DIRECTOR Guide Handle and provides a positive drill stop when used with the Safety Guide Wire. Use of these components requires the ACUFEX DIRECTOR ACL system.

Reference #	Description	Reference #	Description
7207223	ACUFEX DIRECTOR PCL Drill Guide System	<b>Optional components</b>	
<b>System includes</b>		7207291	PCL Twin Tunnel Template
7207282	ACUFEX DIRECTOR PCL Tibial Aimer	7207292	Oval Sizing Tube/Dilator
7207283	ACUFEX DIRECTOR PCL Femoral Aimer	013670	PCL Tibial Rasp
7207281	ACUFEX DIRECTOR PCL Safety Stop	013671	PCL Tibial Curette, closed
7207285	PCL Elevator with Wire Catcher	013672	PCL Tibial Hook Knife
	Requires one of the following ACL Drill Guide Systems (not included): All of the following systems require an Angled Bullet for tibia and a 4-point Bullet for femur.	013673	PCL Tibial Curette, open
		013674	PCL Femoral Curette, calibrated
72201746	ACUFEX DIRECTOR ELITE ACL Drill Guide System	013629	PCL Screwdriver
		013622	PCL 8 mm Drill Stop
72201965	ACUFEX DIRECTOR ELITE Soft Tissue Drill Guide System	013623	PCL 9 mm Drill Stop
		013624	PCL 10 mm Drill Stop
72201967	ACUFEX DIRECTOR ELITE Bone-Tendon-Bone Drill Guide System	013625	PCL 11 mm Drill Stop
		7207357	Large Generic Sterilization Tray
72201966	ACUFEX DIRECTOR ELITE RCI Drill Guide System	<b>Disposables required</b>	
		7207284	PCL Safety Guide Wire (required) Calibrated guide wire used in conjunction with the ACUFEX DIRECTOR PCL Safety Stop to indicate when the tip of the wire has penetrated the posterior cortex.
72201968	ACUFEX DIRECTOR ELITE Rear Entry Drill Guide System	<b>Optional</b>	
		014723*	7.9 mm ACUFEX SMOOTHER Crucial Tool†, sterile (optional)
		014724	9.5 mm ACUFEX SMOOTHER Crucial Tool†, sterile (optional)

\* For two-incision techniques only

† Removes operative debris and leads graft into tunnels

## ACL/PCL Reconstruction Drill Guide System

### ACUFEX<sup>®</sup> DIRECTOR System Set Components



ACUFEX DIRECTOR Drill Guide

Requires ACUFEX DIRECTOR Aimer and ACUFEX Director Bullet, not included.

Reference #	Description
7205517	ACUFEX DIRECTOR Drill Guide Our most rigid, accurate guide. Designed for easy, single-handed placement.



ACUFEX DIRECTOR Aimers

Reference #	Description
7205518	ACUFEX DIRECTOR ACL <b>Elbow</b> Aimer For drilling to the laser mark at the aimer's elbow; useful when the ACL stump is not removed from the tibia.



Reference #	Description
7205519	ACUFEX DIRECTOR ACL <b>Tip</b> Aimer For drilling to the tip of the aimer; useful when the ACL stump is completely removed from the tibia.



Reference #	Description
7207282	ACUFEX DIRECTOR PCL <b>Tibial</b> Aimer Rigid design along with calibrated tip results in consistent, accurate guide wire placement; broad face of tip easily passes through notch and provides a means of protecting posterior capsule during guide wire drilling.



Reference #	Description
7207283	ACUFEX DIRECTOR PCL <b>Femoral</b> Aimer For outside-in drilling with medial incision. Rigid design along with calibrated tip results in consistent, accurate guidewire placement; hoop tip provides a visual reference for the diameter of the fully reamed tunnel, helping avoid tunnel encroachment on the articular surface.

## ACL/PCL Reconstruction Drill Guide System

### ACUFEX<sup>®</sup> DIRECTOR System Set Components



ACUFEX DIRECTOR Bullets

Reference #	Description
7205524	ACUFEX DIRECTOR Angled Bullet, 2.4 mm I.D. Tip angle matches the engagement angle of the ACUFEX DIRECTOR Guide on the tibia for secure placement.



Reference #	Description
7205525	ACUFEX DIRECTOR 4-point Bullet, 2.4 mm I.D. Four sharp points for secure engagement of the ACUFEX DIRECTOR Guide at any angle.

Reference #	Description
3134263	4-point Bullet with 4.5 mm cannulation



## ACL/PCL Drill Guide System Components and Accessories

### Offset Guides and Aimers



#### Anti-Impingement Device

Allows the surgeon to check for impingement before drilling the tibial tunnel. The reusable device snaps on the tibial guide wire and verifies adequate notch clearance as the knee is extended.

Reference #	Description
-------------	-------------

7205587	5 mm, used with 9 mm and 10 mm grafts
7205588	4 mm, used with 7 mm and 8 mm grafts

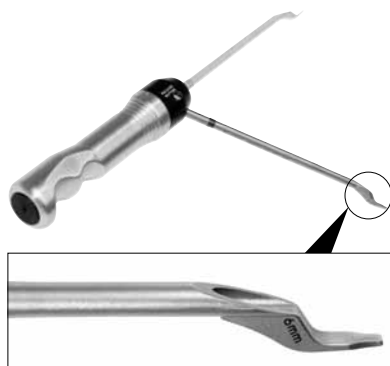

#### Endoscopic Femoral Guide System

Easily and effectively determines femoral guide wire placement by referencing the over-the-top position through the tibial tunnel. Straight or offset positions to work in-line or at 60° angle. Color coded for guide identification of size.

Reference #	Description
-------------	-------------

72201732	Universal EndoFemoral Aimer Handle
72201737	EndoFemoral Aimer, no offset
72201713	Endoscopic Femoral Aimer Arm, 3 mm offset
72201714	Endoscopic Femoral Aimer Arm, 4 mm offset
72201715	Endoscopic Femoral Aimer Arm, 5 mm offset
72201716	Endoscopic Femoral Aimer Arm, 6 mm offset
72201717	Endoscopic Femoral Aimer Arm, 7 mm offset

#### Optional

7207694	Inline Endoscopic Femoral Guide Handle (cannulated)
014800	Non-cannulated handle

#### Made to Order – Endoscopic Femoral Aimers

Reference #	Description
-------------	-------------

⚙ 3134213	Aimer, EndoFemoral (no offset)
⚙ 3134250	Aimer, EndoFemoral 7 mm offset, 2.7 mm I.D., with rounded prongs and Hudson Adapter
⚙ 3134251	Aimer, EndoFemoral 6 mm offset, 2.7 mm I.D., with rounded prongs and Hudson Adapter
⚙ 3134252	Aimer, EndoFemoral 5 mm offset, 2.7 mm I.D., with rounded prongs and Hudson Adapter



#### Offset Drill Guides

Assists in repositioning guide wire from primary guide wire location.

Reference #	Description
-------------	-------------

7205521	2–5 mm Offset Guide Unique design utilizes an integral guide pin to provide offsets as low as 2 mm
7205522	3–9 mm Offset Guide 1 mm increments allow precise repositioning of guide wires; 9 mm maximum offset aids in placement of parallel wires for twin tunnel techniques



# ACL/PCL Drill Guide System Components and Accessories

## Rear Entry Components



### Rear Entry Femoral Aimers

Reference #	Description
013642*	Rear Entry Aimer, right, shown with Tri-Point Bullet, included



Reference #	Description
013643*	Rear Entry Aimer, left, shown with Tri-Point Bullet, included



Reference #	Description
013644*	Rear Entry Introducer



Reference #	Description
013645*	Tri-Point Bullet Used with Rear Entry Aimers (REF 013642 and 013643) and Puddu Aimers (REF 013696 and 013597)

### Crucial Tools

#### ACUFEX<sup>®</sup> SMOOTHER

Removes operative debris and leads graft into tunnels.



Reference #	Description
014723*	7.9 mm, sterile
014724	9.5 mm, sterile



Reference #	Description
013646*	2.4 mm Tri-Point K-Wire Sleeve Used with ACL handle

## ACL/PCL Drill Guide System Components and Accessories

### Drill Bits, Routers and Bone Graft Components



#### Cannulated Drill Bits

Used with ACL and PCL Drill Guide Systems, 2.4 mm I.D., 7" (17.75 cm) length.

Reference #	Description	Reference #	Description
013498	5 mm	013546	10 mm
7207491	5.5 mm	7207487	10.5 mm
013542	6 mm	013547	11 mm
7207483	6.5 mm	7207488	11.5 mm
013543	7 mm	013548*	12 mm
7207484	7.5 mm	7207489	12.5 mm
013544	8 mm	013549	13 mm
7207485	8.5 mm	7207490	13.5 mm
013545	9 mm	013551	14 mm
7207486	9.5 mm		



#### Endoscopic Cannulated Drill Bits

Used with Endoscopic ACL Drill Guide Systems for Femoral Tunnel Drilling, 2.4 mm I.D., 7" (17.75 cm) length, calibrated.

Reference #	Description
7207315	4.5 mm (use with ENDOBUTTON®, ENDOBUTTON CL or RCI screws), sterile, disposable, single use
013184*	4.5 mm (use with ENDOBUTTON, ENDOBUTTON CL or RCI screws), non-sterile, disposable, single use
72202971	4.5 mm CLANCY Flexible Drill



Reference #	Description	Reference #	Description
7208686	5 mm	7207495	9.5 mm
7207482	5.5 mm	013663*	10 mm
013499	6 mm	7207496	10.5 mm
7207492	6.5 mm	013664	11 mm
013660	7 mm	7207497	11.5 mm
7207493	7.5 mm	013665	12 mm
013661	8 mm	7207498	12.5 mm
7207494	8.5 mm	013666	13 mm
013662	9 mm		

## ACL/PCL Drill Guide System Components and Accessories

### Drill Bits, Routers and Bone Graft Components



#### Drill Bits Single Flute – Endoscopic Cannulated

Reference #	Description
3134179	5.5 mm Single Flute drill bit
3134180	6 mm Single Flute drill bit
3134181	6.5 mm Single Flute drill bit
3134182	7 mm Single Flute drill bit
3134183	7.5 mm Single Flute drill bit
3134184	8 mm Single Flute drill bit
3134185	8.5 mm Single Flute drill bit
3134186	9 mm Single Flute drill bit
3134187	9.5 mm Single Flute drill bit
3134188	10 mm Single Flute drill bit
3134189	10.5 mm Single Flute drill bit
3134190	11 mm Single Flute drill bit
3134191	11.5 mm Single Flute drill bit
3134192	12 mm Single Flute drill bit
3134193	12.5 mm Single Flute drill bit
3134194	13 mm Single Flute drill bit

#### Drill Bit for DonJoy RCI Tibial Guide

Reference #	Description
6900854	4.5 mm non-cannulated drill bit

#### RCI Stepped Routers

Patented design compacts the drilled bone into the tunnel wall for improved graft fixation. Wings at the proximal end of the cutting head chamfer the tunnel entrance to minimize stress risers and accommodate the RCI Screw.



#### RCI Tibial Stepped Routers

Reference #	Description
7207167	6.5 mm Tibial Stepped router
7207168	7 mm Tibial Stepped router
7207171	7.5 mm Tibial Stepped router
7207172	8 mm Tibial Stepped router
7207173*	8.5 mm Tibial Stepped router



#### RCI Femoral Stepped Routers

Reference #	Description
7207174	6.5 mm Femoral Stepped router
7207175	7 mm Femoral Stepped router
7207176	7.5 mm Femoral Stepped router
7207177	8 mm Femoral Stepped router
7207178*	8.5 mm Femoral Stepped router

\* Item shown

# ACL/PCL Drill Guide System Components and Accessories

## Drill Bits, Routers and Bone Graft Components

### Routers – Wingless RCI Routers

With laser markings 5 mm to 120 mm in 5 mm increments.

Reference #	Description
7207761	Router, Femoral 6.5 mm wingless
7207762	Router, Femoral 7 mm wingless
7207763	Router, Femoral 7.5 mm wingless
7207764	Router, Femoral 8 mm wingless
7207765	Router, Femoral 8.5 mm wingless
7207766	Router, Femoral 9 mm wingless
7207767	Router, Femoral 9.5 mm wingless
7207768	Router, Femoral 10 mm wingless
7207769	Router, Femoral 10.5 mm wingless
7207770	Router, Femoral 11 mm wingless

### Routers – RCI Routers

With laser markings 30 mm to 80 mm in 10 mm increments.

Reference #	Description
3134273	Router, Femoral 6.5 mm
3134274	Router, Femoral 7 mm
3134275	Router, Femoral 7.5 mm
3134276	Router, Femoral 8 mm
3134277	Router, Femoral 8.5 mm

### Pins and Wires (non-sterile)

Reference #	Description
3134221	Blunt Tip Passing Pin, 2.4 mm x 17" (43 cm) (1 per package)
3134284	Blunt Tip Passing Pin, 2.4 mm x 17" (43 cm), with notched eyelet (1 per package)
7207703	Drill Tip Guide Wire, 2.4 mm x 12" (30 cm) (6 per package)
7207776	Trocar-Tip Screw Guide Wire, 1 mm x 12" (30 cm) (6 per package)

### Bone Graft Compressors

Reference #	Description
7209281	9 mm Bone Graft Compressor, with 2.5 mm hole and 1 mm slot
7209282	10 mm Bone Graft Compressor, with 2.5 mm hole and 1 mm slot
7209283	11 mm Bone Graft Compressor, with 2.5 mm hole and 1 mm slot

# ACL/PCL Drill Guide System Components and Accessories

## Sizing Tubes, Dilators and Blocks

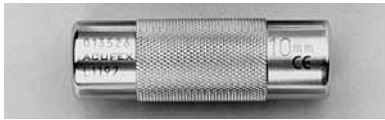

### Graft Sizing Tubes

Used with ACL and PCL Drill Guide Systems to size the graft for precise graft tunnel interface.

Reference #	Description	Reference #	Description
7207499	5 mm	013526*	10 mm
7207500	5.5 mm	7207502	10.5 mm
013522	6 mm	013527	11 mm
7207163	6.5 mm	7207503	11.5 mm
013523	7 mm	013528	12 mm
7207164	7.5 mm	7207504	12.5 mm
013524	8 mm	013529	13 mm
7207165	8.5 mm	7207505	13.5 mm
013525	9 mm	013540	14 mm
7207501	9.5 mm		



### Dilators

Expands bone tunnels by compacting cancellous bone in the tibial and femoral tunnel walls. Tray holds 1/2 mm size drill bits, making it a comprehensive soft tissue graft accessory system.

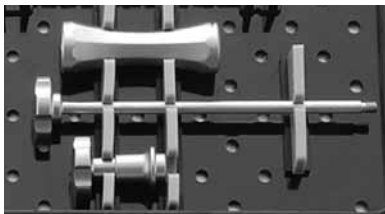

Reference #	Description	7207878 Comprehensive System	7209066 Basic System
7207640	6 mm	•	
7207641	6.5 mm	•	
7207642	7 mm	•	
7207643	7.5 mm	•	•
7207644	8 mm	•	•
7207645	8.5 mm	•	•
7207646	9 mm	•	•
7207647	9.5 mm	•	•
7207648	10 mm	•	
7207649	11 mm	•	
7207650*	12 mm	•	
7207638	Sizing Block	•	•
7209214*	Slotted Sizing Block		
7207639*	Slaphammer	•	•
	Minimizes the potential for creating oval-shaped tunnels when using T-handle -style dilators	•	•
7207637	Tray	•	•

### Made to Order Accessories

Reference #	Description
⚙️ 6900876	T-Handle to remove dilators (sold separately from the system)

\* Item shown

# ACL/PCL Drill Guide System Components and Accessories

## ACL Arthroplasty Instruments



### NOTCHMASTER® Instruments

Reference #	Description
7205622	NOTCHMASTER 8 mm angled curette Designed specifically to facilitate the removal of soft tissue and bone from the notch during notchplasty

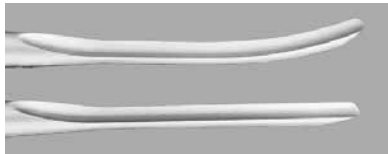

Reference #	Description
012724	6.4 mm NOTCHMASTER, curved gouge
012722	6.4 mm NOTCHMASTER, straight gouge



### Osteotome

Reference #	Description
012701	Straight



### Gouge

Reference #	Description
012702	Compound curved



### Curettes

Reference #	Description
012704	4 mm, open
012717	7 mm, open



012703*	3 mm, closed
012710	5 mm, closed

\* Item shown

# ACL/PCL Drill Guide System Components and Accessories

## ACL Arthroplasty Instruments



### Rasps

Reference #	Description
-------------	-------------

012705	Convex
--------	--------



Reference #	Description
-------------	-------------

012708	Compound Curve
--------	----------------



### ACL Chamfering Rasps

Reference #	Description
-------------	-------------

013569	Bone Tunnel
--------	-------------



Reference #	Description
-------------	-------------

013570	Chamfering
--------	------------



Reference #	Description
-------------	-------------

013571	8 mm, half-round
--------	------------------



Reference #	Description
-------------	-------------

013572	7 mm, half-round
--------	------------------



Reference #	Description
-------------	-------------

72201734	6 mm, half-round
----------	------------------



Reference #	Description
-------------	-------------

72201733	5 mm, half-round
----------	------------------



# ACL/PCL Drill Guide System Components and Accessories

## ACL Arthroplasty Instruments

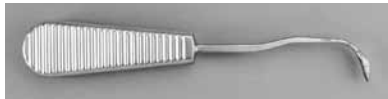

Elevator with Wire Catcher

Indispensable 3-in-1 PCL Accessory Instrument

Reference #	Description
7207285	Elevator with Wire Catcher Sharp elevator tip elevates the PCL and periosteum from the bone when used in the fore/aft plane. Blunt elevator sides open the posterior compartment when used in a rotational motion. Wire capture hole secures the wire while reaming the tibial tunnel, protecting the neurovascular structures from the drill tip as it exits the posterior cortex.



Reference #	Description
013670	PCL Tibial Rasp



Reference #	Description
013672	PCL Tibial Hook Knife



Reference #	Description
013671	PCL Tibial Curette, closed



Reference #	Description
013673	PCL Tibial Curette, open



Reference #	Description
013674	PCL Femoral Curette, calibrated 10 mm from tip



### PCL Drill Stops

Drill Stops designed for use with ACUFEX® Cannulated Drills to limit the depth of drill penetration.

Reference #	Description	Reference #	Description
013620	6 mm	013625*	11 mm
013621	7 mm	013626	12 mm
013622*	8 mm	013627	13 mm
013623*	9 mm	013628	14 mm
013624*	10 mm	013629*	PCL Screwdriver

\* Item shown

⚙️ Special, Made to Order products are available to meet the individual needs of surgeons. Please appreciate that longer lead time for delivery should be expected. For more information, please contact your sales representative or Customer Service.

## ACL/PCL Drill Guide System Components and Accessories

### MCL MicroPerforation Instruments



#### MicroPerforation

MicroPerforation of the medial ligament complex reestablishes an acute healing environment for treatment of sub-acute and chronic MCL laxity. In conjunction with ACL reconstruction, MicroPerforation may stimulate medial complex healing to increase the probability of successful ACL outcome.

Reference #	Description
⚙ 7205975	MicroPerforation Instrument, small concave
⚙ 7205976	MicroPerforation Instrument, small convex
⚙ 7205977	MicroPerforation Instrument, large concave
⚙ 7205978	MicroPerforation Instrument, large convex

### Bone Tunnel Plugs



#### Bone Tunnel Plugs – Cannulated

Single use, sterile

Reference #	Description
014477	Cannulated, fits 7–12 mm tunnels, latex-free (6 per box)
7210149	Cannulated, fits 7–12 mm tunnels, contains latex (6 per box)

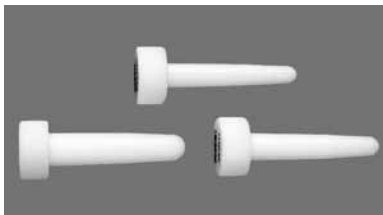

#### Bone Tunnel Plugs – Non-Cannulated

Made of polyacetal, non-sterile

Reference #	Description
013563	Set (3 small, 3 medium, 3 large)
72201735	X-small, 5–6 mm (3 per package)
013560	Small, 7–8 mm (3 per package)
013561	Medium, 9–10 mm (3 per package)
013562	Large, 10–11 mm (3 per package)
013589	Set (3 large, 3 X-large, 3 XX-large)
013587	X-large, 11–12 mm (3 per package)
013588	XX-large, 13–14 mm (3 per package)
013592	Comprehensive set (3 small, 3 medium, 3 large, 3 X-large, 3 XX-large)
7207724	Blue silicon plug, reusable
72201735	5–6 mm Bone tunnel plug

# ACL/PCL Drill Guide System Components and Accessories

## Isometry

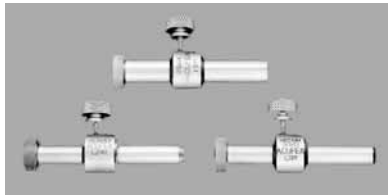

ISOTAC Tibial Guides

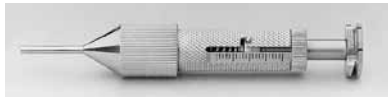

Isometric Positioner



ISOTAC Driver

### ISOTAC System

For determining isometric femoral tunnel location in cruciate reconstruction.

Reference #	Description
-------------	-------------

013581	ISOTAC System
--------	---------------

### System includes

013580	Isometric Positioner
013582	ISOTAC Driver
013652	7–8 mm Adjustable ISOTAC Tibial Guide
013653	9–10 mm Adjustable ISOTAC Tibial Guide
013654	11 mm+ Adjustable ISOTAC Tibial Guide
011703	Small Sterilization Tray

### Single use

013583	ISOTAC, sterile, disposable
013593	Suture Retriever, sterile, disposable (6 per box)
014399	ISOTAC Pilot Wire, sterile, disposable
400235	Replacement Gaskets – O ring



### Isometry Disposables

Reference #	Description
-------------	-------------

013583	ISOTAC, sterile, single use (6 per box) Requires #2 braided suture, not included
--------	---



Reference #	Description
-------------	-------------

014399*	ISOTAC Pilot Wire, 2 mm x 9" (23 cm) long, sterile, single use
013619	ISOTAC Pilot Wire, 2 mm x 9" (23 cm) long, non-sterile, single use (6 per package)

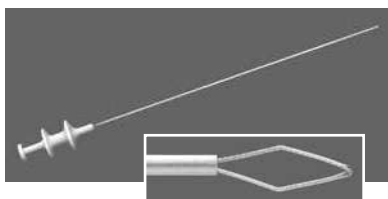

### Suture Retriever

Used for passing or retrieving sutures through instrumentation with cannulations of 1.5 mm or larger; used in conjunction with Isometric Positioner, ISOTAC Driver, ENDOBUTTON® and Passing Pins.

Reference #	Description
-------------	-------------

013593	Suture Retriever, sterile, single use (6 per box)
--------	---

## ACL/PCL Drill Guide System Components and Accessories

### Cruciate Pins and Wires

#### Drill-Tip Passing Pins

With eyelet for graft passage



Reference #	Description
72202009	2.7 mm x 15" (38 cm) Graduated Drill-Tip Passing Pin, 2.7 mm diameter head 2.4 mm diameter shaft, sterile, single use (6 per package)
014508*	2.7 mm x 15" (38 cm) Drill-Tip Passing Pin, 2.7 mm diameter head, 2.4 mm diameter shaft, sterile, single use (6 per package)
014485	2.7 mm x 15" (38 cm) Drill-Tip Passing Pin, 2.7 mm diameter head, 2.4 mm diameter shaft, non-sterile, single use (6 per package)
72202817	2.4 mm x 15" (38 cm) Drill-Tip Passing Pin, sterile, single use (6 per package)
7208678	2.4 mm x 15" (38 cm) Graduated Drill-Tip Passing Pin, sterile, single use
1107089	2.4 mm x 12" (30 cm) Beath Pin, two eyelets, sterile, single use (3 per package)

#### Spade-Tip Passing Pin

With eyelet for graft passage



Reference #	Description
013110*	3 mm Spade-Tip Passing Pin, 2.4 mm diameter shaft x 11" (28 cm) long, non-sterile, single use (6 per package)
013111	4 mm Spade-Tip Passing Pin, 2.4 mm diameter shaft x 11" (28 cm) long, non-sterile, single use (6 per package)

#### Trocar-Tip Passing Pin

With eyelet for graft passage



Reference #	Description
014395	2.4 mm x 11" (28 cm) Trocar-Tip Passing Pin, sterile, single use (1 per box)
7207220*	2.4 mm x 17" (43 cm) Trocar-Tip Passing Pin, sterile, single use (1 per box)
72202816	2.4 mm x 11" (28 cm) Trocar-Tip Passing Pin, sterile, single use (6 per package)
7207702	2.4 mm x 17" (43 cm) Trocar-Tip Passing Pin, non-sterile, single use (6 per package)

#### Cruciate Guide Wires

For use with ACUFEX<sup>®</sup> cruciate guides and cannulated drill bits



Reference #	Description
72202872*	2.4 mm Drill-Tip Guide Wire, 10" (25 cm) long, no eyelet, sterile, single use (6 per package)
014396	2.4 mm Drill-Tip Guide Wire, 10" (25 cm) long, no eyelet, sterile, single use (1 per box)
7207221	2.4 mm Drill-Tip Guide Wire, 12" (30 cm) long, no eyelet, sterile, single use (1 per box)
7207284	PCL Safety Guide Wire, 2.4 mm x 10" (25 cm) long, no eyelet, sterile, single use, calibrated for use with the ACUFEX DIRECTOR PCL Safety Stop (1 per box)
72202389	2.4 mm Drill-Tip Guide Wire, 12" (30 cm) long, no eyelet, sterile, single use (6 per box)

\* Item shown

# ACL/PCL Drill Guide System Components and Accessories

## Cruciate Pins and Wires

### Cruciate Pins and Wires

Guide wire for femoral tunnel, includes eyelet for passing pin

Reference #	Description	Quantity	Sterility	Systems
014395	Trocar-Tip Passing Pin, 2.4 mm x 11" (28 cm)	1	Sterile	ACUFEX <sup>®</sup> ACL & PCL Systems
72202816	Trocar-Tip Passing Pin, 2.4 mm x 11" (28 cm)	6	Sterile	
7208678	Drill-Tip Passing Pin, 2.4 mm x 15" (38 cm)	1	Sterile	
72202817	Drill-Tip Passing Pin, 2.4 mm x 15" (38 cm)	6	Sterile	
7207220	Trocar-Tip Passing Pin, 2.4 mm x 17" (43 cm)	1	Sterile	
014508	Drill-Tip Passing Pin, 2.7 mm x 15" (38 cm)	6	Sterile	
014485	Drill-Tip Passing Pin, 2.7 mm x 15" (38 cm)	6	Non-sterile	
013110	Spade-Tip Passing Pin, 3.0 mm x 11" (28 cm)	6	Non-sterile	
013111	Spade-Tip Passing Pin, 4.0 mm x 11" (28 cm)	6	Non-sterile	

### Cruciate Pins and Wires

Guide wire for endo and cannulated drills, and all ACUFEX guides

Reference #	Description	Quantity	Sterility	Systems
014396	Drill-Tip Guide Wire, 2.4 mm x 10" (25 cm)	1	Sterile	ACUFEX ACL & PCL Systems
72202872	Drill-Tip Guide Wire, 2.4 mm x 10" (25 cm)	6	Sterile	
7207221	Drill-Tip Guide Wire, 2.4 mm x 12" (30 cm)	1	Sterile	
7207284	PCL Safety Guide Wire, 2.4 mm x 10" (25 cm)	1	Sterile	

### Cruciate Pins and Wires

Drills ISOTAC pilot hole

Reference #	Description	Quantity	Sterility	Systems
014399	ISOTAC Pilot Wire	1	Sterile	ISOTAC
013619	ISOTAC Pilot Wire	6	Non-sterile	

### Screw Guide Wires

Guide screw into a position parallel to bone block

Reference #	Description	Quantity	Sterility	Systems
014394	CANNU-FLEX <sup>®</sup> Screw Guide Wire, blunt, 1 mm x 12" (30 cm)	1	Sterile	CANNU-FLEX SILK 1.0
72202873	CANNU-FLEX Screw Guide Wire, blunt, 1 mm x 12" (30 cm)	6	Sterile	
013475	CANNU-FLEX Screw Guide Wire, trocar, 1 mm x 9" (23 cm)	6	Non-sterile	
014698	CANNU-FLEX Screw Guide Wire, blunt, 1 mm x 9" (23 cm)	6	Non-sterile	
014859	CANNU-FLEX Screw Guide Wire, 1.5 mm x 12" (30 cm)	1	Sterile	SOFTSILK <sup>®</sup> 1.5, SILK 1.5,
014545	CANNU-FLEX Screw Guide Wire, 1.5 mm x 12" (30 cm)	6	Non-sterile	BIORCI <sup>®</sup> , BIORCI-HA, and
72202810	CANNU-FLEX Screw Guide Wire, 1.5 mm x 9" (23 cm)	6	Sterile	ENDO-FIX <sup>®</sup>
7207775	CANNU-FLEX Screw Guide Wire, 1.5 mm x 15" (38 cm)	6	Non-sterile	
72202881	CANNU-FLEX Screw Guide Wire, 2 mm x 9" (23 cm)	6	Sterile	SOFTSILK 2.0 & RCI
7205658	CANNU-FLEX Screw Guide Wire, 2 mm x 12" (30 cm)	6	Non-sterile	
7205659	CANNU-FLEX Screw Guide Wire, 2 mm x 12" (30 cm)	1	Sterile	
7207222	CANNU-FLEX Screw Guide Wire, 2 mm x 15" (38 cm)	1	Sterile	

## ACL/PCL Drill Guide System Components and Accessories

### Cruciate Accessory Pacs

#### RAP-PAC<sup>®</sup>

Comprehensive cruciate accessory pac for reconstruction when isometry is not selected. Sterile, single-use.

#### RAP-PAC A – 1.2

Reference #	Description
72202796	1.2 RAP-PAC A latex free

#### Contains 1 each of the following:

7207221	2.4 mm x 12" Drill Tip Guide Wire
72202009	2.7 mm Drill Tip Passing Pin
7211138	1.2 mm x 12" Guide Wire
014477	Cannulated Bone Tunnel Plug, latex free
72200948	TRUKOR <sup>®</sup> Gauge

#### RAP-PAC B – 1.2

Reference #	Description
72202797	1.2 RAP-PAC B latex free

#### Contains 1 each of the following:

7207221	2.4 mm x 12" Drill Tip Guide Wire
7208678	2.4 mm x 15" Drill Tip Passing Pin
7211138	1.2 mm x 12" Guide Wire (5 per package)
014477	Cannulated Bone Tunnel Plug, latex free
72200948	TRUKOR Gauge

#### RAP-PAC C – 1.2

Reference #	Description
72202798	1.2 RAP-PAC C latex free

#### Contains 1 each of the following:

7207221	2.4 mm x 12" Drill Tip Guide Wire
7208678	2.4 mm x 15" Drill Tip Passing Pin
72201201	1.2 mm x 18" Guide Wire (5 per package)
014477	Cannulated Bone Tunnel Plug, latex free
72200948	TRUKOR Gauge

#### ENDOBUTTON<sup>®</sup> CL ULTRA PAC – 1.2

Reference #	Description
72202799	1.2 ENDOBUTTON <sup>®</sup> CL ULTRA Pac

#### Contains 1 each of the following:

	ENDOBUTTON CL Sizing Chart
013184	Cannulated Endoscopic Drill, 4.5 mm
7207221	2.4 mm Drill Tip Guide Wire
72202009	2.7 mm x 15" Drill Tip Passing Pin
7211138	1.2 mm x 12" Guide Wire (5 per package)
014477	Cannulated Bone Tunnel Plug, latex free
72200948	TRUKOR Gauge

## ACL/PCL Drill Guide System Components and Accessories

### Cruciate Accessory Pacs

#### RAP-PAC<sup>®</sup>

Comprehensive cruciate accessory pac for reconstruction when isometry is not selected. Sterile, single-use.

#### RAP-PAC

Reference #	Description
-------------	-------------

014725	RAP-PAC, latex-free
7210151	RAP-PAC, contains latex

#### RAP-PAC includes

013593	Suture Retriever
014396	2.4 mm x 10" Drill-Tip Guide Wire
014508	2.7 mm x 15" Drill-Tip Passing Pin
014394	CANNU-FLEX <sup>®</sup> Screw Guide Wire, 1 mm x 12"
014859	CANNU-FLEX Screw Guide Wire, 1.5 mm x 12"
7210118	7 mm CLEAR-TRAC <sup>®</sup> Screw Cannula, latex seal (included in REF 7210151 only)
7207227	7 mm CLEAR-TRAC Screw Cannula, latex-free seal (included in REF 014725 only)
014477	Cannulated Bone Tunnel Plug, latex-free (included in REF 014725 only)
7210149	Cannulated Bone Tunnel Plug, contains latex (included in REF 7210151 only)

#### RAP-PAC 1.5

Reference #	Description
-------------	-------------

7209217	RAP-PAC 1.5, latex-free
7210154	RAP-PAC 1.5, contains latex

#### RAP-PAC 1.5 includes

014396	2.4 mm x 10" Drill-Tip Guide Wire
014508	2.7 mm x 15" Drill-Tip Passing Pin
7207775	1.5 mm CANNU-FLEX Screw Guide Wire, 15"
014477	Cannulated Bone Tunnel Plug, latex-free (included in REF 7209217 only)
7210149	Cannulated Bone Tunnel Plug, contains latex (included in REF 7210154 only)

#### RAP-PAC 2

Reference #	Description
-------------	-------------

7209218	RAP-PAC 2, latex-free
7210155	RAP-PAC 2, contains latex

#### RAP-PAC 2 includes

014396	2.4 mm x 10" Drill-Tip Guide Wire
014508	2.7 mm x 15" Drill-Tip Passing Pin
7207222	2 mm CANNU-FLEX Screw Guide Wire, 15"
014477	Cannulated Bone Tunnel Plug, latex-free (included in REF 7209218 only)
7210149	Cannulated Bone Tunnel Plug, contains latex (included in REF 7210155 only)

## ACL/PCL Drill Guide System Components and Accessories

### Cruciate Accessory Pacs

#### Pin and Wire Pac A

Reference #	Description
7207738	Pin and Wire Pac A
<b>Pac A includes</b>	
7207221	2.4 mm x 12" Drill-Tip Guide Wire
7207220	2.4 mm x 17" Passing Pin with Trocar Tip
014859	1.5 mm x 12" CANNU-FLEX <sup>®</sup> Screw Guide Wire

#### Pin and Wire Pac B

Reference #	Description
7207925	Pin and Wire Pac B
<b>Pac B includes</b>	
7207221	2.4 mm x 12" Drill-Tip Guide Wire
7207220	2.4 mm x 17" Passing Pin with Trocar Tip
7207222	2 mm x 15" CANNU-FLEX Screw Guide Wire

#### Pin and Wire Pac C

Reference #	Description
7207926	Pin and Wire Pac C
<b>Pac C includes</b>	
7207221	2.4 mm x 12" Drill-Tip Guide Wire
014508	2.7 mm x 15" Drill-Tip Passing Pin
014859	1.5 mm x 12" CANNU-FLEX Screw Guide Wire

#### Pin and Wire Pac D – Latex-free

Reference #	Description
7207940	Pin and Wire Pac D, latex-free
<b>Pac D includes</b>	
7207221	2.4 mm x 12" Drill Tip Guide Wire
014508	2.7 mm x 15" Drill-Tip Passing Pin
014859	1.5 mm x 12" CANNU-FLEX Guide Wire
014477	Cannulated Bone Tunnel Plug, latex-free

#### Pin and Wire Pac E

Reference #	Description
7209203	Pin and Wire Pac E
<b>Pac E includes</b>	
014396	2.4 mm x 10" Drill-Tip Guide Wire
014508	2.7 mm x 15" Drill-Tip Passing Pin
014394	1 mm x 12" CANNU-FLEX Screw Guide Wire (2)

#### Pin and Wire Pac F

Reference #	Description
7210157	Pin and Wire Pac F, contains latex
<b>Pac F includes</b>	
7207221	2.4 mm x 12" Drill-Tip Guide Wire
7207220	2.4 mm x 17" Passing Pin with Trocar Tip
014859	1.5 mm x 12" CANNU-FLEX <sup>®</sup> Screw Guide Wire
7210149	Cannulated Bone Tunnel Plug, contains latex

#### Made to Order Pin and Wire Pac F – latex free

Reference #	Description
7209313	Pin and Wire Pac F, latex-free
<b>Pac F includes</b>	
7207221	2.4 mm x 12" Drill Tip Guide Wire
7207220	2.4 mm x 17" Passing Pin with Trocar Tip
014859	1.5 mm x 12" CANNU-FLEX Guide Wire
014477	Cannulated Bone Tunnel Plug, latex-free



## ACL/PCL Drill Guide System Components and Accessories

### Cruciate Accessory Pacs

#### ENDOBUTTON® CL Pac

Comprehensive cruciate accessory pac for reconstruction with ENDOBUTTON.

Sterile, single use.

Reference #	Description
7209216	ENDOBUTTON CL Pac, latex-free
7210153	ENDOBUTTON CL Pac, contains latex

#### ENDOBUTTON CL Pac includes

	ENDOBUTTON CL sizing chart
013184	Cannulated Endoscopic Drill, 4.5 mm
014396	2.4 mm x 10" Drill-Tip Guide Wire
014508	2.7 mm x 15" Drill-Tip Passing Pin
014477	Cannulated Bone Tunnel Plug, latex-free (included in REF 7209216 only)
7210149	Cannulated Bone Tunnel Plug, contains latex (included in REF 7210153 only)

#### ENDOBUTTON Pac

Comprehensive cruciate accessory pac for reconstruction with ENDOBUTTON.

Sterile, single use.

Reference #	Description
014893	ENDOBUTTON Pac, latex-free
7210152	ENDOBUTTON Pac, contains latex

#### ENDOBUTTON Pac includes

013186	ENDOBUTTON
013184	Cannulated Endoscopic Drill, 4.5 mm
014396	2.4 mm x 10" Drill-Tip Guide Wire
014508	2.7 mm x 15" Drill-Tip Passing Pin
014477	Cannulated Bone Tunnel Plug, latex-free (included in REF 014893 only)
7210149	Cannulated Bone Tunnel Plug, contains latex (included in REF 7210152 only)

#### ENDOBUTTON Pac A

Reference #	Description
7209204	ENDOBUTTON Pac A

#### ENDOBUTTON Pac A includes

014396	2.4 mm x 10" Drill-Tip Guide Wire
014508	2.7 mm x 15" Drill-Tip Passing Pin
013184	Cannulated Endoscopic Drill, 4.5 mm

## ACL/PCL Drill Guide System Components and Accessories

### Cruciate Accessory Pacs

#### ISO-PAC

Comprehensive cruciate accessory pac for reconstruction when isometry is selected.

Sterile, single use.

Reference #	Description
014518	ISO-PAC, latex-free
7210150	ISO-PAC, contains latex
<b>ISO-PAC includes</b>	
013583	ISOTAC
014399	ISOTAC Pilot Wire
014396	2.4 mm x 10" Drill Tip Guide Wire
014508	2.7 mm x 15" Drill-Tip Passing Pin
014394	1 mm x 12" CANNU-FLEX <sup>°</sup> Screw Guide Wire (2)
7210118	7 mm CLEAR-TRAC <sup>°</sup> Screw Cannula, latex seal (included in REF 7210150 only)
7207227	7 mm CLEAR-TRAC Screw Cannula, latex-free seal (included in REF 014518 only)
013593	Suture Retriever
014477	Cannulated Bone Tunnel Plug, latex-free (included in REF 014518 only)
7210149	Cannulated Bone Tunnel Plug, contains latex (included in REF 7210150 only)

# Chondral Resurfacing Systems

## MOSAICPLASTY<sup>®</sup>

MOSAICPLASTY is an autogenous osteochondral transplantation system that allows for arthroscopic or open treatment of cartilaginous defects of the knee and ankle.

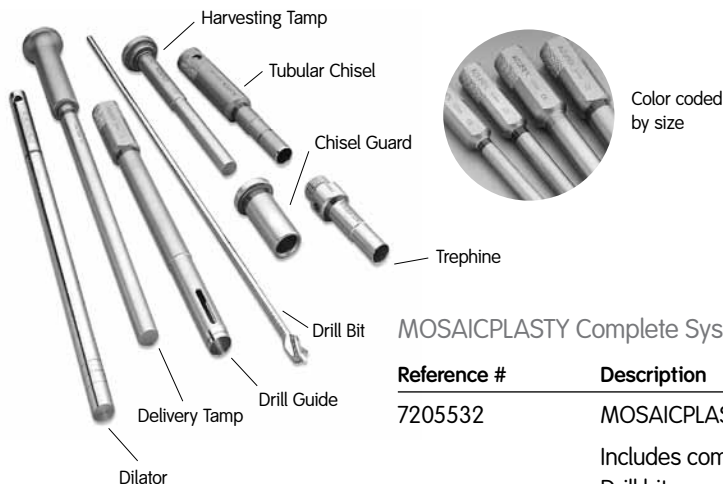

### MOSAICPLASTY Complete System

Reference #	Description
7205532	MOSAICPLASTY Complete System Includes components listed on pg. A-63 Drill bits required but not included MOSAICPLASTY Complete Sterilization Tray included (REF 7205507) Trepshines for hard bone coring optional but not included

### MOSAICPLASTY Precision System

Reference #	Description
7205605*	MOSAICPLASTY Precision System Includes only 2.7 mm, 3.5 mm and 4.5 mm components Drill bits required but not included MOSAICPLASTY Precision Sterilization Tray included (REF 72202428) Trepshines for hard bone coring optional but not included

### MOSAICPLASTY DP Disposable System

Requires the use of the Graft Placement Drill Guides, Dilators, and Delivery Tamps.

Reference #	Description
7209234	Disposable Harvesting Set, 3.5, includes disposable chisel, tamp, and drill bit, blue
7209235	Disposable Harvesting Set, 4.5, includes disposable chisel, tamp, and drill bit, green
7209236	Disposable Harvesting Set, 6.5, includes disposable chisel, tamp, and drill bit, yellow
7209237	Disposable Harvesting Set, 8.5, includes disposable chisel, tamp, and drill bit, red

### Made to Order Arthroscopic MOSAICPLASTY Guides

Requires the use of the Graft Placement Drill Guides, Dilators, and Delivery Tamps.

Reference #	Description
⚙️ 3134226	Drill Guide, AMP 4.5 mm with 5 mm slot at distal end
⚙️ 3134227	Drill Guide, AMP 6.5 mm with 5 mm slot at distal end

\* Item shown

⚙️ Special, Made to Order products are available to meet the individual needs of surgeons. Please appreciate that longer lead time for delivery should be expected. For more information, please contact your sales representative or Customer Service.

## Chondral Resurfacing Systems

### MOSAICPLASTY<sup>®</sup>

#### Graft Harvesting

##### Tubular Chisels (five to ten patient uses)

Reference #	Description
7207099*	2.7 mm Tubular Chisel
7207098*	3.5 mm Tubular Chisel
7207097*	4.5 mm Tubular Chisel
7205493	6.5 mm Tubular Chisel
7205494	8.5 mm Tubular Chisel

#### Graft Harvesting

##### Chisel Guards

Reference #	Description
7207208*	2.7 mm Chisel Guard
7207209*	3.5 mm Chisel Guard
7207210*	4.5 mm Chisel Guard
7205499	6.5 mm Chisel Guard
7205500	8.5 mm Chisel Guard

#### Graft Harvesting

##### Harvesting Tamps

Reference #	Description
7207107*	2.7 mm Harvesting Tamp
7207106*	3.5 mm Harvesting Tamp
7207105*	4.5 mm Harvesting Tamp
7205495	6.5 mm Harvesting Tamp
7205496	8.5 mm Harvesting Tamp

#### Optional – Graft Harvesting

##### Trephines (for hard bone)

Reference #	Description
7207089	2.7 mm Trephine
7207088	3.5 mm Trephine
7207087	4.5 mm Trephine
7205497	6.5 mm Trephine
7205498	8.5 mm Trephine
7207103	Trephine Adapter for 2.7 mm, 3.5 mm and 4.5 mm sizes
7205515	Trephine Adapter for 6.5 mm and 8.5 mm sizes

#### Graft Placement

##### Drill Guides (five to ten patient uses)

Reference #	Description
7207214*	2.7 mm Drill Guide
7207215*	3.5 mm Drill Guide
7207216*	4.5 mm Drill Guide
7205501	6.5 mm Drill Guide
7205502	8.5 mm Drill Guide

#### Graft Placement

##### Dilators

Reference #	Description
7205509*	2.7 mm Dilator
7205510*	3.5 mm Dilator
7205511*	4.5 mm Dilator
7205512	6.5 mm Dilator
7205513	8.5 mm Dilator

#### Graft Placement

##### Delivery Tamps

Reference #	Description
7207205*	2.7 mm Delivery Tamp
7207206*	3.5 mm Delivery Tamp
7207207*	4.5 mm Delivery Tamp
7205505	6.5 mm Delivery Tamp
7205506	8.5 mm Delivery Tamp

#### Required – Disposables

##### Drill Bits (non-sterile)

Reference #	Description
7205508	2.7 mm Drill Bit
7207212	3.5 mm Drill Bit
7207213	4.5 mm Drill Bit
7205503	6.5 mm Drill Bit
7205504	8.5 mm Drill Bit

# Chondral Resurfacing Systems

## Chondral Picks



Chondral Picks  
For chondral resurfacing.

Reference #	Description
72201883	Chondral Pick, small, 20°
72201884	Chondral Pick, large, 20°
72201885	Chondral Pick, small, 40°
72201886	Chondral Pick, large, 40°
72201736	Chondral Pick, small, 90°



Reference #	Description
72201732	Universal EndoFemoral Aimer Handle

# Patient Positioning

## SPIDER2 Limb Positioner

### Simplified hands-free positioning.

Versatile and controlled, the SPIDER2 Limb Positioner allows for a full range of motion in arthroscopic and open knee procedures. Developed utilizing years of surgeon feedback, the SPIDER2 Limb Positioner offers:

- Full range of motion with easy manipulation to attain 90° or hyperflexed positions (110° and 130° of knee flexion)
- Easy disconnection of boot during surgery
- Ability to make subtle changes to internal/external rotation
- Stable positioning for meniscal repairs, including figure-four position

Reference #	Description
72203299	SPIDER2 Limb Positioner
72203300	Switch Drape (20 per case)
72203301	SPIDER2 Battery Pack
7210570	Piggy Back Connector (2 per box, required for all sterile procedures)
72203235	SPIDER Leg Accessory, Left
72203236	SPIDER Leg Accessory, Right
72203238	SPIDER Leg Stabilization Kit (10 per case)
72203239	3D SPIDER Connector (1 required for each Leg Accessory)

### Accessories

72200918	SPIDER Cart
----------	-------------



Knee Positioning, 90°



Knee Positioning, Hyperflexing

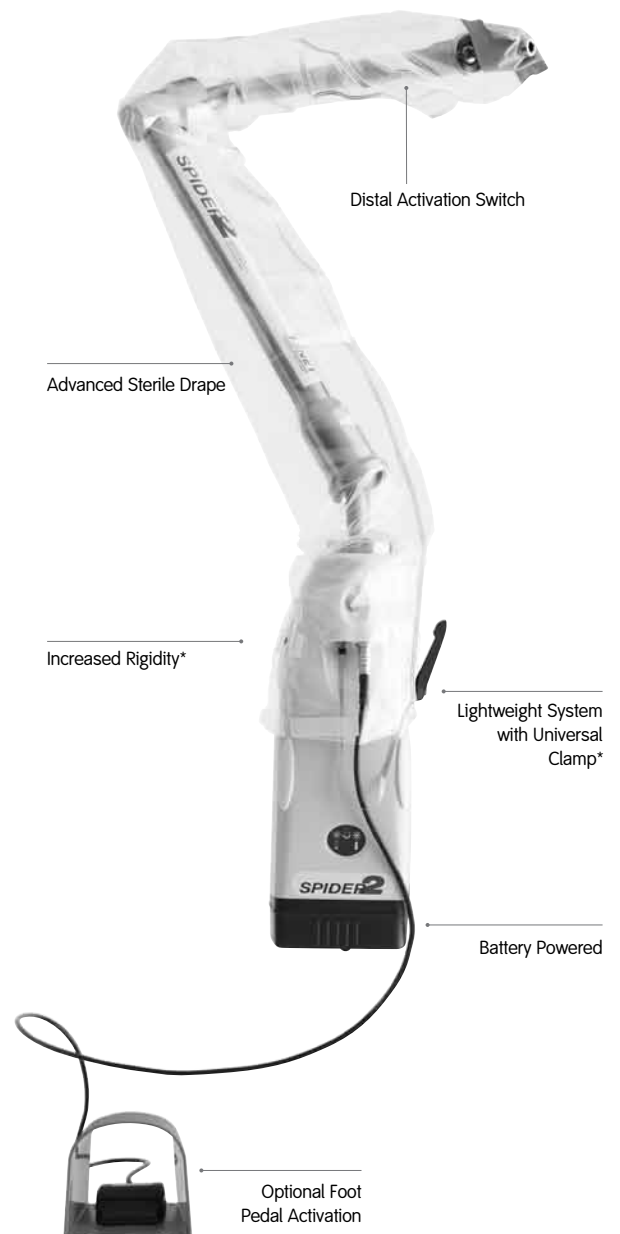

\* Data on file with Smith & Nephew

## Cruciate Reconstruction

### Leg Holder, Pads and Inserts



Leg Holder and Pads

Reference #	Description
012310*	Leg Holder (Table Clamp not included)
013227	Table Clamp
012311	Replacement Lateral Leg Pad (included with REF 012310)
354010	Faucet knob



Reference #	Description
3757	Disposable Leg Holder Pads, non-sterile, 3.5" W x 1.375" D x 38" L, used with Smith & Nephew Leg Holder, REF 2921 (discontinued), case of 12



SURGICAL ASSISTANT Leg Holder

Reference #	Description
7209451	SURGICAL ASSISTANT Leg Holder, includes REF 7209450 and 7209452
7209450	SURGICAL ASSISTANT T-Bar
7209452	SURGICAL ASSISTANT Replacement Cross Bar



SURGICAL ASSISTANT Leg Holder Foam Inserts

Reference #	Description
7209456	Reusable Foam Insert, grey (1 each)
7209457	Disposable Foam Insert, blue (20 per box)
7209458	Disposable Foam Insert, white (20 per box)



Made to Order – SURGICAL ASSISTANT Leg Holder, Low Profile

Reference #	Description
⚙️ 7209453	Low Profile Surgical Assist Leg Holder
⚙️ 7209454	Low Profile Replacement Bar
⚙️ 7209455	Low Profile Replacement Peg and Chain
⚙️ 7209459	Low Profile Disposable Foam Insert, blue (20 per box)
⚙️ 7209460	Low Profile Reusable Foam Insert, grey (1 each)

## ARTHROPAK

### Customized Procedure Kit



#### ARTHROPAK Customized Procedure Kit

Smith & Nephew DYONICS® ARTHROPAK Customized Procedure Kits provide increased operational efficiencies and reduced supply expense. You customize your kit with your selection of disposable Smith & Nephew products for any arthroscopic procedure at a reduced cost.

- Free customized service
- Reduced product cost
- Save valuable time and demand on staff
- Streamlined ordering process
- Increased standardization
- Reduced inventory

DYONICS ARTHROPAK Customized Procedure Kits reduce the number of SKUs that need to be ordered and aggregate purchasing volume of arthroscopic products by enabling purchase from a single supplier. Please ask your local sales representative to demonstrate how DYONICS ARTHROPAK Customized Procedure Kits can benefit your practice.





**BIORAPTOR® CURVED  
OSTEORAPTOR® CURVED**  
Suture Anchors and Guide System

B



- Curved Drill Guides with a 25° bend improve the trajectory of drilling and optimize anchor placement in the glenoid<sup>1</sup>
- Internal structures are better protected, as the Curved Drill Guides angle the Flexible Twist Drill and anchor into bone and away from the surface<sup>1</sup>

<sup>1</sup> Data on file at Smith & Nephew, ITR-15001065, 2011

**SPIDER2**  
Limb Positioner



- Advanced Sterile Drape features integrated patient positioning switch
- Distal activation switch eliminates the need for a foot pedal
- Rechargeable Battery eliminates the inconvenience of a power cord

## Rotator Cuff Soft Tissue Fixation

### HEALICOIL<sup>®</sup> PK Suture Anchors (non-absorbable)



#### HEALICOIL PK Suture Anchors

The unique open-architecture design of the HEALICOIL PK Suture Anchor utilizes significantly less material than standard solid-core anchors, dramatically minimizing the volume of material implanted in the shoulder. The HEALICOIL PK anchor inserts easily into all densities of humeral bone. Torque is distributed along the length of the anchor during insertion and improved anchor thread engagement in the bone delivers superior pullout strength.



The HEALICOIL PK Suture Anchors can be used for primary or double row repairs and in the medial row of a suture bridging technique.

#### Non-absorbable

Our non-absorbable PK suture anchors incorporate PEEK-OPTIMA<sup>®</sup> polymer from Invibio<sup>®</sup>. PEEK-OPTIMA material provides an ideal combination of strength, biocompatibility, revisability and inherent radiolucent characteristics.

Reference #	Description
72203378	4.5 mm HEALICOIL PK Suture Anchor with two ULTRABRAID <sup>®</sup> (#2) Sutures (blue, blue-COBRAID), sterile
72203379	5.5 mm HEALICOIL PK Suture Anchor with Two ULTRABRAID (#2) Sutures (blue, blue-COBRAID), sterile
72203380	5.5 mm HEALICOIL PK Suture Anchor with Three ULTRABRAID (#2) Sutures (blue, blue-COBRAID, COBRAID-black), sterile

#### Instruments

72202621	3.8 mm Tapered Awl, disposable (general hole preparation for normal bone quality)
72201915	3.8 mm Tapered Awl, reusable (general hole preparation for normal bone quality)
72203335	4.5 mm HEALICOIL Awl Dilator, reusable (hole preparation for normal and hard bone quality)
72203336	5.5 mm HEALICOIL Awl Dilator, reusable (hole preparation for normal and hard bone quality)
72203482	3.5 mm HEALICOIL Spade Tip Drill for use with 4.5 mm HEALICOIL Suture Anchor
72203483	4.5 mm HEALICOIL Spade Tip Drill for use with 5.5 mm HEALICOIL Suture Anchor

## Rotator Cuff Soft Tissue Fixation

### TWINFIX<sup>®</sup> Ultra HA Suture Anchors



#### TWINFIX Ultra HA Suture Anchors

Available in a variety of size options with a choice of suture configurations, TWINFIX Ultra Suture Anchors can be used for primary or double row repairs and for the medial row of a suture bridging technique.

#### Absorbable

Our absorbable HA suture anchor combines poly-L-lactic acid (PLLA) with hydroxyapatite (HA), a calcium phosphate similar to the mineral compound of bone. Once absorbed, it has the fracture resistance of human cortical bone.\* HA is a natural bone mineral shown to promote bone replacement.†

Reference #	Description
72202597	4.5 mm TWINFIX Ultra HA Anchor with two #2 sutures (white, COBRAID-blue), sterile
72202624	4.5 mm TWINFIX Ultra HA Anchor with two #2 sutures (COBRAID-blue, COBRAID-black), sterile
72202602	5.5 mm TWINFIX Ultra HA Anchor with two #2 sutures (white, COBRAID-blue), sterile
72202626	5.5 mm TWINFIX Ultra HA Anchor with two #2 sutures (COBRAID-blue, COBRAID-black), sterile
72202603	5.5 mm TWINFIX Ultra HA Anchor with three #2 sutures (white, COBRAID-blue, COBRAID-black)
72202608	6.5 mm TWINFIX Ultra HA Anchor with two #2 sutures (white, COBRAID-blue), sterile
72202631	6.5 mm TWINFIX Ultra HA Anchor with two #2 sutures (COBRAID-blue, COBRAID-black), sterile
72202610	6.5 mm TWINFIX Ultra HA Anchor with three #2 sutures (white, COBRAID-blue, COBRAID-black), sterile
<b>Instruments</b>	
72202633	4.5 Awl Dilator for use with 4.5 mm anchor hole preparation
72202634	5.5/6.5 Awl Dilator for use with 6.5 mm anchor hole preparation
72202116	3.5 mm Spade Tip Drill for use with 4.5 mm anchor hole preparation device for hard bone
72201707	4.5 mm Spade Tip Drill for use with 5.5 mm anchor hole preparation device for hard bone
72201708	5.5 mm Spade Tip Drill for use with 6.5 mm anchor hole preparation device for hard bone

\* Akao, M., Aoki, H. and Kato, K., Mechanical properties of sintered hydroxyapatite for prosthetic applications. *Journal of Material Science*: 16, 809–812, (1981).

† S.D. Cook, D.A. Funk, T.P. Schmalzried. Orthopedic Biomaterials and Implant Fixation, instructional course lecture, AAOS 63rd meeting.

## Rotator Cuff Soft Tissue Fixation

### TWINFIX<sup>®</sup> Ultra PK Suture Anchors



#### TWINFIX Ultra PK Suture Anchors

Available in a variety of size options with a choice of suture configurations, TWINFIX Ultra Suture Anchors can be used for primary or double row repairs and for the medial row of a suture bridging technique.

#### Non-absorbable

Our non-absorbable PK suture anchor incorporates PEEK-OPTIMA<sup>®</sup> polymer from Invibio<sup>®</sup>. With a modulus similar to cortical bone, PEEK-OPTIMA exhibits an ideal combination of strength, biocompatibility, revisability and inherent radiolucent characteristics.

Reference #	Description
72202595	4.5 mm TWINFIX Ultra PK Anchor with two #2 sutures (white, COBRAID-blue), sterile
72202623	4.5 mm TWINFIX Ultra PK Anchor with two #2 sutures (COBRAID-blue, COBRAID-black), sterile
72203103	4.5 mm TWINFIX Ultra Anchor with two #2 sutures (blue, blue-COBRAID), sterile
72202599	4.5 mm TWINFIX Ultra PK Anchor with two #2 sutures (white, COBRAID-blue), sterile
72202625	5.5 mm TWINFIX Ultra PK Anchor with two #2 sutures (COBRAID-blue, COBRAID-black), sterile
72202600	5.5 mm TWINFIX Ultra PK Anchor with three #2 sutures (white, COBRAID-blue, COBRAID-black), sterile
72203104	5.5 mm TWINFIX Ultra PK Anchor with two #2 sutures (blue, blue-COBRAID), sterile
72202605	6.5 mm TWINFIX Ultra PK Anchor with two #2 sutures (white, COBRAID-blue), sterile
72202630	6.5 mm TWINFIX Ultra PK Anchor with two #2 sutures (COBRAID-blue, COBRAID-black), sterile
72202606	6.5 mm TWINFIX Ultra PK Anchor with three #2 sutures (white, COBRAID-blue, COBRAID-black), sterile
72203105	6.5 mm TWINFIX Ultra PK Anchor with two #2 sutures (blue, blue-COBRAID), sterile
<b>Instruments</b>	
72202621	3.8 Tapered Awl – Disposable for use with general hole preparation for normal bone quality
72201915	3.8 Tapered Awl – Reusable for use with general hole preparation for normal bone quality
72202633	4.5 Awl – Dilator for use with 4.5 mm anchor hole preparation for hard bone
72202634	5.5/6.5 Awl – Dilator for use with 5.5/6.5 mm anchor hole preparation for hard bone
72202116	3.5 mm Spade Tip Drill for use with 4.5 mm anchor hole preparation for hard bone
72201707	4.5 mm Spade Tip Drill for use with 5.5 mm anchor hole preparation for hard bone
72201708	5.5 mm Spade Tip Drill for use with 6.5 mm anchor hole preparation for hard bone

## Rotator Cuff Soft Tissue Fixation

### TWINFIX<sup>®</sup> Ultra Ti Suture Anchors



#### TWINFIX Ultra Ti Suture Anchors

Available in a variety of size options with a choice of suture configurations, TWINFIX Ultra Suture Anchors can be used for primary or double row repairs and for the medial row of a suture bridging technique.

#### Non-absorbable

Titanium (Ti) suture anchors exhibit ideal fixation strength and anchor stability. Elongated distal trocar tips allow anchors to be self-tapping; without the need to predrill in most bone qualities.

Reference #	Description
72202893	4.5 mm TWINFIX Ultra Ti Anchor with two #2 sutures (white, COBRAID-blue), sterile
72202894	4.5 mm TWINFIX Ultra Ti Anchor with two #2 sutures (COBRAID-blue, COBRAID-black), sterile
72202895	5.5 mm TWINFIX Ultra Ti Anchor with two #2 sutures (white, COBRAID-blue), sterile
72202896	5.5 mm TWINFIX Ultra Ti Anchor with two #2 sutures (COBRAID-blue, COBRAID-black), sterile
72202897	5.5 mm TWINFIX Ultra Ti Anchor with three #2 sutures (white, COBRAID-blue, COBRAID-black), sterile
72202898	6.5 mm TWINFIX Ultra Ti Anchor with two #2 sutures (white, COBRAID-blue), sterile
72202899	6.5 mm TWINFIX Ultra Ti Anchor with two #2 sutures (COBRAID-blue, COBRAID-black), sterile
72202900	6.5 mm TWINFIX Ultra Ti Anchor with three #2 sutures (white, COBRAID-blue, COBRAID-black), sterile

#### Instruments:

72202116	3.5 mm Spade Tip Drill for use with 4.5 mm anchor hole preparation device for hard bone
72201707	4.5 mm Spade Tip Drill for use with 5.5 mm anchor hole preparation device for hard bone
72201708	5.5 mm Spade Tip Drill for use with 6.5 mm anchor hole preparation device for hard bone
72202621	3.8 mm Tapered Awl-Disposable
72201915	3.8 mm Tapered Awl-Reusable

## Rotator Cuff Soft Tissue Fixation

### TWINFIX<sup>®</sup> Ultra Suture Anchors with Needles

Easy-to-use handles for speed and efficiency. TWINFIX Ultra Preloaded Suture Anchors with Needles combine best-in-class anchor pullout strength\* with controlled suture and needle management for your mini-open rotator cuff repairs.

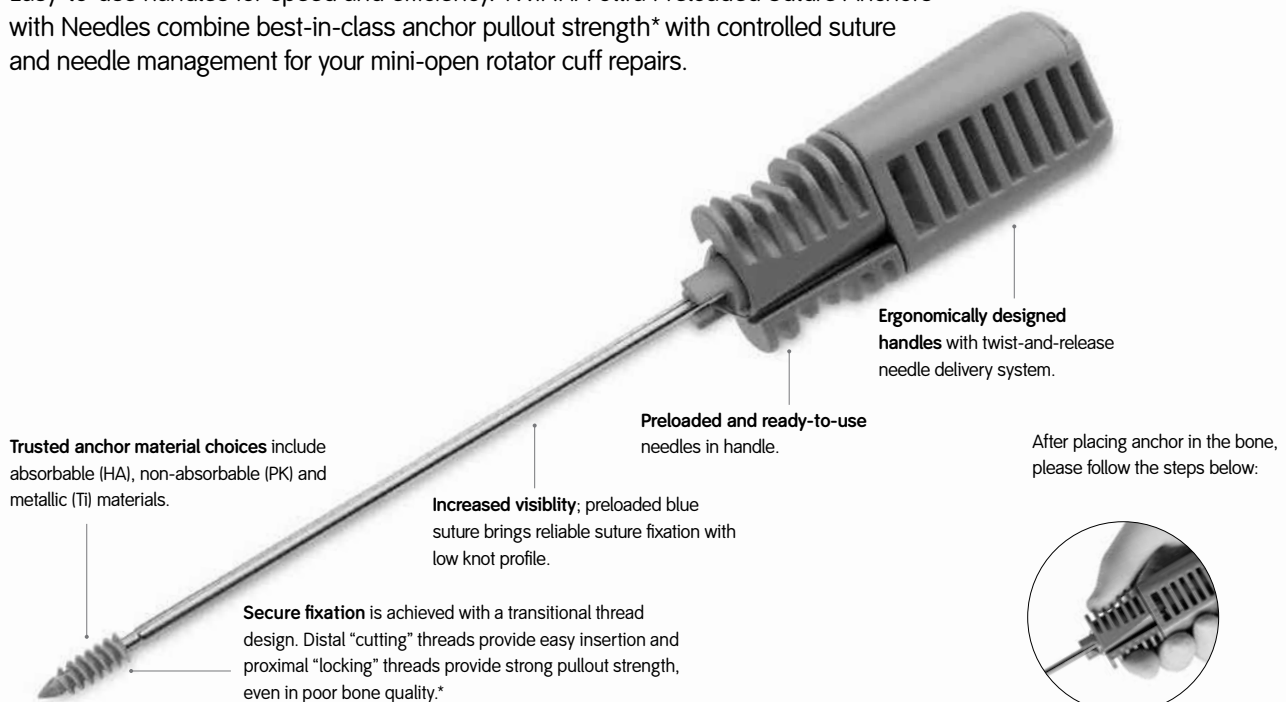

Step 1 – Ready



Step 2 – Twist



Step 3 – Full Turn

Reference #	Description
72202611	4.5 mm TWINFIX Ultra PK Suture Anchor with two #2 ULTRABRAID <sup>®</sup> Sutures (blue, blue-COBRAID) with Needles
72202615	5.5 mm TWINFIX Ultra PK Suture Anchor with two #2 ULTRABRAID Sutures (blue, blue-COBRAID) with Needles
72202619	6.5 mm TWINFIX Ultra PK Suture Anchor with two #2 ULTRABRAID Sutures (blue, blue-COBRAID) with Needles
72202612	4.5 mm TWINFIX Ultra PLLA-HA Suture Anchor with two #2 ULTRABRAID Sutures (blue, blue-COBRAID) with Needles
72202616	5.5 mm TWINFIX Ultra PLLA-HA Suture Anchor with two #2 ULTRABRAID Sutures (blue, blue-COBRAID) with Needles
72202620	6.5 mm TWINFIX Ultra PLLA-HA Suture Anchor with two #2 ULTRABRAID Sutures (blue, blue-COBRAID) with Needles
72202613	4.5 mm TWINFIX Ultra Ti Suture Anchor with two #2 ULTRABRAID Sutures (blue, blue-COBRAID) with Needles
72202618	5.5 mm TWINFIX Ultra Ti Suture Anchor with two #2 ULTRABRAID Sutures (blue, blue-COBRAID) with Needles
72202622	6.5 mm TWINFIX Ultra Ti Suture Anchor with two #2 ULTRABRAID Sutures (blue, blue-COBRAID) with Needles

\* Data on file at Smith & Nephew 2009, ITR-4091, ITR-4039, ITR-3952.

## Rotator Cuff Soft Tissue Fixation – Absorbable Polymer Anchors

### TWINFIX® AB 5.0 and TWINFIX AB 6.5 Suture Anchors



The unique thread design of the TWINFIX AB anchors provides extraordinary pullout strength and easy insertion in all bone conditions, and provides superior solutions to the orthopaedic surgeon. The absorbable material is time tested and proven PLLA.

#### TWINFIX AB 5.0 and TWINFIX AB 6.5 with DURABRAID® Suture

Reference #	Description
72200785	5.0 mm TWINFIX AB Suture Anchor, PLLA, with two #2 preloaded DURABRAID sutures, sterile
72200786	5.0 mm TWINFIX AB Suture Anchor, PLLA, with two #2 preloaded DURABRAID sutures packaged with threaded dilator, sterile
7210309	5.0 mm TWINFIX AB Suture Anchor, PLLA, with two #2 preloaded DURABRAID sutures with needles, sterile
7210304	5.0 mm TWINFIX AB Suture Anchor, PLLA, with two #2 preloaded DURABRAID sutures with needles, packaged with threaded dilator, sterile
72200787	6.5 mm TWINFIX AB Suture Anchor, PLLA, with two #2 preloaded DURABRAID sutures, sterile
72200788	6.5 mm TWINFIX AB Suture Anchor, PLLA, with two #2 preloaded DURABRAID sutures, packaged with threaded dilator, sterile
7210211	6.5 mm TWINFIX AB Suture Anchor, PLLA, with two #2 preloaded DURABRAID sutures with needles, sterile
7210212	6.5 mm TWINFIX AB Suture Anchor, PLLA, with two #2 preloaded DURABRAID sutures with needles, packaged with threaded dilator, sterile

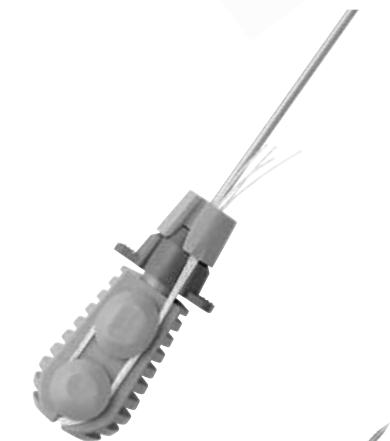

#### Accessories

Reference #	Description
7209946	5.0 mm TWINFIX AB threaded dilator, reusable
7210819	6.5 mm TWINFIX AB threaded dilator, reusable
72201178*	5.0 mm TWINFIX AB Awl/threaded dilator, reusable
72200819	5.0 mm TWINFIX AB Suture Anchor threaded dilator, sterile
72200820	6.5 mm TWINFIX AB Suture Anchor threaded dilator, sterile



## Rotator Cuff Soft Tissue Fixation – Absorbable Polymer Anchors

### TWINFIX<sup>®</sup> AB 5.0 and TWINFIX AB 6.5 Suture Anchors

TWINFIX AB 5.0 and TWINFIX AB 6.5 with ULTRABRAID<sup>®</sup> Suture

Reference #	Description
72200777	5.0 mm TWINFIX AB Suture Anchor, PLLA, with two #2 preloaded ULTRABRAID sutures <sup>†</sup> , sterile
7210710	5.0 mm TWINFIX AB Suture Anchor, PLLA, with two #2 preloaded ULTRABRAID sutures <sup>†</sup> with needles, sterile
72200778	5.0 mm TWINFIX AB Suture Anchor, PLLA, with two #2 preloaded ULTRABRAID sutures <sup>†</sup> , packaged with threaded dilator, sterile
7210711	5.0 mm TWINFIX AB Suture Anchor, PLLA, with two #2 preloaded ULTRABRAID sutures <sup>†</sup> with needles, packaged with threaded dilator, sterile
72200688 <sup>‡</sup>	5.0 mm TWINFIX AB Suture Anchor, PLLA, with two #2 preloaded ULTRABRAID sutures <sup>†</sup> , packaged (3 per box) without threaded dilator, sterile, Suture Anchor Pack
72200789 <sup>‡</sup>	5.0 mm TWINFIX AB Suture Anchor, PLLA, with two #2 preloaded ULTRABRAID sutures <sup>†</sup> , packaged with one threaded dilator, sterile, no needles (5 per box)
72200779	6.5 mm TWINFIX AB Suture Anchor, PLLA, with two #2 preloaded ULTRABRAID sutures <sup>†</sup> , sterile
7210712	6.5 mm TWINFIX AB Suture Anchor, PLLA, with two #2 preloaded ULTRABRAID sutures <sup>†</sup> with needles, sterile
72200780	6.5 mm TWINFIX AB Suture Anchor, PLLA, with two #2 preloaded ULTRABRAID sutures <sup>†</sup> , packaged with threaded dilator, sterile
7210713	6.5 mm TWINFIX AB Suture Anchor, PLLA, with two #2 preloaded ULTRABRAID sutures <sup>†</sup> with needles, packaged with threaded dilator, sterile

#### Accessories

Reference #	Description
7209946	5.0 mm TWINFIX AB threaded dilator, reusable
7210819	6.5 mm TWINFIX AB threaded dilator, reusable
72201178*	5.0 mm TWINFIX AB Awl/threaded dilator, reusable
72200819	5.0 mm TWINFIX AB Suture Anchor threaded dilator, sterile
72200820	6.5 mm TWINFIX AB Suture Anchor threaded dilator, sterile

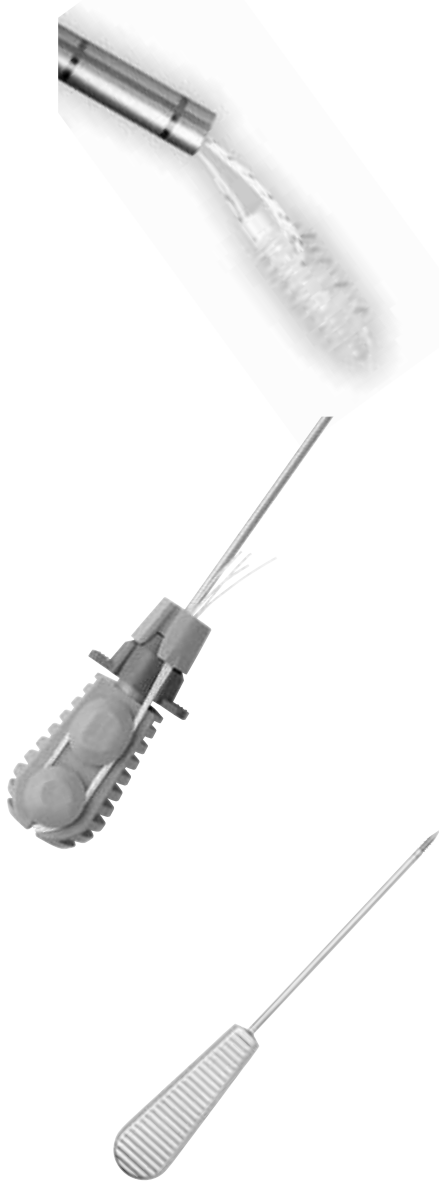

## Rotator Cuff Soft Tissue Fixation – Non-absorbable Polymer Anchors

### TWINFIX<sup>®</sup> PK FT Suture Anchors

#### TWINFIX PK FT Suture Anchors

The TWINFIX PK FT anchor is a fully threaded combination tap-in/screw-in anchor designed for rotator cuff repair. Made with radiolucent high strength PEEK-OPTIMA<sup>®</sup> polymer from Invibio<sup>®</sup>, the anchor has versions loaded with two or three ULTRABRAID<sup>®</sup> sutures. An awl is used for hole preparation, and a drill is also available for use with hard bone applications.



Reference #	Description
72201576	5.5 mm TWINFIX PK FT Anchor with two #2 sutures (COBRAID-blue, white ULTRABRAID), sterile
72201578	5.5 mm TWINFIX PK FT Anchor with two #2 sutures (COBRAID-blue, white ULTRABRAID), sterile, with awl
72201681	6.5 mm TWINFIX PK FT Anchor with two #2 sutures (COBRAID-blue, white ULTRABRAID), sterile
72201683	6.5 mm TWINFIX PK FT Anchor with two #2 sutures (COBRAID-blue, white ULTRABRAID), sterile, with awl
72201577	5.5 mm TWINFIX PK FT Anchor with three #2 sutures (white, COBRAID-blue, COBRAID-black), sterile
72201579	5.5 mm TWINFIX PK FT Anchor with three #2 sutures (white, COBRAID-blue, COBRAID-black), sterile, with awl
72201682	6.5 mm TWINFIX PK FT Anchor with three #2 sutures (white, COBRAID-blue, COBRAID-black), sterile
72201684	6.5 mm TWINFIX PK FT Anchor with three #2 sutures (white, COBRAID-blue, COBRAID-black), sterile, with awl
72201450	3.8 mm Straight Awl, reusable
72201707	Drill, 4.5 mm for use with the 5.5 PK FT anchor in hard bone
72201708	Drill, 5.5 mm for use with the 6.5 PK FT anchor in hard bone
72200867	Mallet with nylon ends
72202456	5.5 mm TWINFIX PK FT Anchor with two #2 sutures (COBRAID-blue, COBRAID-black)
72202457	5.5 mm TWINFIX PK FT Anchor with two #2 sutures (COBRAID-blue, COBRAID-black), with awl
72202458	6.5 mm TWINFIX PK FT Anchor with two #2 sutures (COBRAID-blue, COBRAID-black)

## Rotator Cuff Soft Tissue Fixation – Metallic Anchors

### TWINFIX<sup>®</sup> Ti 5.0 and TWINFIX Ti 6.5 Suture Anchors

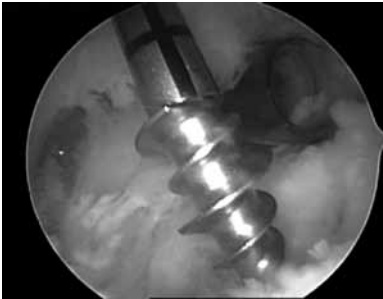

#### TWINFIX Ti Suture Anchors

The unique thread design of the TWINFIX Ti anchors provides extraordinary pullout strength and easy insertion in all bone conditions, and provides superior solutions to the orthopaedic surgeon.

To offer the surgeon flexibility, depending on personal preference and patient profile, TWINFIX anchors are available with DURABRAID<sup>®</sup> and ULTRABRAID<sup>®</sup> suture. ULTRABRAID is constructed from UHMW (ultra-high molecular weight polyethylene) and possesses a unique and proprietary braid configuration. This provides ULTRABRAID with its extraordinary strength properties while contributing to its superior handling qualities.



#### TWINFIX Ti 5.0 and TWINFIX Ti 6.5 with DURABRAID Suture

Reference #	Description
72200766	5.0 mm TWINFIX Ti Suture Anchor with two #2 preloaded DURABRAID sutures, sterile
7210300	5.0 mm TWINFIX Ti Suture Anchor with two #2 preloaded DURABRAID sutures with needles, sterile
72200769	6.5 mm TWINFIX Ti Suture Anchor with two #2 preloaded DURABRAID sutures, sterile
7210214	6.5 mm TWINFIX Ti Suture Anchor with two #2 preloaded DURABRAID sutures with needles, sterile



#### TWINFIX Ti 5.0 and TWINFIX Ti 6.5 with ULTRABRAID Suture

Reference #	Description
72200755	5.0 mm TWINFIX Ti Suture Anchor with two #2 preloaded ULTRABRAID sutures*, sterile
7210708	5.0 mm TWINFIX Ti Suture Anchor with two #2 preloaded ULTRABRAID sutures* with needles, sterile
72200758	6.5 mm TWINFIX Ti Suture Anchor with two #2 preloaded ULTRABRAID sutures*, sterile
7210709	6.5 mm TWINFIX Ti Suture Anchor with two #2 preloaded ULTRABRAID sutures* with needles, sterile
72200687	5.0 mm TWINFIX Ti Suture Anchor with two #2 preloaded ULTRABRAID sutures*, sterile, Suture Anchor Pack (3 per box)
72200759	5.0 mm TWINFIX Ti Suture Anchor with two #2 preloaded ULTRABRAID sutures*, sterile, no needles (5 per box)

#### TWINFIX Ti 5.0 and TWINFIX Ti 6.5 Instruments

Reference #	Description
7210269	6" Drill Guide – 6" x 6.5 mm Spiked Tip for 6.5 mm TWINFIX Ti anchor
7209115	6" Drill Guide – 6" x 5 mm Spiked Tip for 5.0 mm TWINFIX Ti anchor
7209502	2.5 mm Drill for TWINFIX Ti 3.5 mm and 5.0 mm anchor
7210215	3.5 mm Drill for TWINFIX Ti 6.5 mm anchor
72201406	12" Suture Passer, sterile
72201407	2" Suture Passer, sterile

\* One ULTRABRAID white suture and one ULTRABRAID COBRAID suture

## Rotator Cuff Soft Tissue Fixation – Metallic Anchors

### TWINFIX Ti QUICK-T Fixation System

#### TWINFIX Ti QUICK-T Fixation System

The TWINFIX Ti QUICK-T Fixation System provides a single-step tissue repair method that can be used for primary or secondary tissue fixation. This through-tendon technique combines the proven TWINFIX Ti Soft Tissue Anchor with pre-tied knot technology, coupling the anchor with a high strength “T” bar made of PEEK-OPTIMA® LT3 polymer from Invibio®. The result is a secure, adjustable fixation system that can be used wherever a larger tissue footprint is needed.

The QUICK-T System gives surgeons the unique ability to arthroscopically perform high strength, multi-row repairs more closely resembling those found in open or mini-open procedures. The low profile “T” component is delivered through the standard anchor delivery system, eliminating the need for special cannulae, and the “T” provides a 10 mm tissue bridge once it’s deployed and secured to the tissue surface.

The QUICK-T System is also an excellent solution for biceps tenodesis and non-retracted and isolated supraspinatus tear repairs. Using the QUICK-T increases the tissue-to-bone contact area, recreating the natural footprint of the rotator cuff.

Reference #	Description
72200767	5.0 mm TWINFIX Ti QUICK-T Fixation System, sterile
72200764	3.5 mm TWINFIX Ti QUICK-T Fixation System, sterile
7210116	ELITE Premium KNOT MANIPULATOR, QUICK-T, reusable, black loop
7209417	TWINFIX QUICK-T Knot Pusher and Suture Cutter, sterile, disposable
72200768	5.0 mm TWINFIX QUICK-T implant with QUICK-T Knot Pusher and Suture Cutter, sterile
72200765	3.5 mm TWINFIX QUICK-T implant with QUICK-T Knot Pusher and Suture Cutter, sterile
7209114	Drill guide, 5" x 4.0 mm, for use with 3.5 mm QUICK-T device
7209502	Drill, 2.5 mm for TWINFIX Ti 3.5 mm and 5.0 mm anchors, suitable for Quick-T Systems

## Rotator Cuff Soft Tissue Fixation – Metallic Anchors Individually Packaged Anchors and Accessories

Individually packaged anchors

Anchors packaged without sutures or needles

Reference #	Description
7209107	2.8 mm TWINFIX <sup>®</sup> Ti single anchor, sterile
7209108	4.0 mm TWINFIX Ti single anchor, sterile
7209105	5.0 mm TWINFIX Ti single anchor, sterile
7209109	6.5 mm TWINFIX Ti single anchor, sterile

### Accessories

72201406	12" Suture Passer, single use, sterile
72201407	2" Suture Passer, single use, sterile
7209119	Insertor, TWINFIX Ti 4.0 mm and 6.5 mm, cannulated
7209120	Insertor Shaft, TWINFIX Ti 2.8 mm, short 3", working length
7209121	Insertor Shaft, TWINFIX Ti 2.8 mm, short 6", working length
7209165	2.5 mm Drill for TWINFIX 4.0 mm, 5.0 mm, and 6.5 mm anchors
7209111	6.5 mm Drill Guide, Spiked Tip

## Rotator Cuff Soft Tissue Fixation

### FOOTPRINT Ultra PK Suture Anchor



#### FOOTPRINT Ultra PK Suture Anchor

Available in two sizes, 4.5 mm and 5.5 mm, the FOOTPRINT Ultra PK anchor is intended for use in the lateral row in double row suture bridging techniques.

- Uniquely designed, inner plug adjustability means more **precise** fixation and suture **tensioning** of final repair
- **Reduced suture slippage** means less gap formation and rotator cuff displacement\*
- Exclusive tap-in anchor design with offset barbed geometry threads means **high pullout strength** and **easy insertion**\*

Reference #	Description
72202901	4.5 mm FOOTPRINT Ultra Suture Anchor
72202902	5.5 mm FOOTPRINT Ultra Suture Anchor

#### Instruments

72202621	3.8 mm Tapered Awl-Disposable
72201915	3.8 mm Tapered Awl-Reusable
72202116	3.5 mm Spade Tip Drill for use with the 4.5 mm anchor hole preparation device for hard bone
72201707	4.5 mm Spade Tip Drill for use with the 5.5 mm anchor hole preparation device for hard bone
72201450	3.8 mm Straight Awl-Reusable
72202986	3.8 mm Straight Awl-Disposable



## Rotator Cuff Soft Tissue Fixation – Non-absorbable Polymer Anchors

### FOOTPRINT PK Suture Anchor



#### FOOTPRINT PK Suture Anchor

The FOOTPRINT PK Suture Anchor consists of a non-absorbable polymer (PEEK-OPTIMA® polymer from Invibio®). The sizes include a 5.5 mm anchor, and a back-up size of 6.5 mm. The anchor is composed of two parts, the “outer shell” and the “inner plug.” The design allows the anchor to be tapped in. Then, independent of implantation, the inner plug is screwed down, securing the medial anchor suture limbs that have been captured in the nose of the anchor.

The FOOTPRINT PK Suture Anchor offers a rotator cuff repair technique that allows the surgeon to precisely apply the desired amount of suture tension that is appropriate and customized for each patient. The suture tension can be adjusted even after the anchor is implanted, unlike any competitive product on the market.

Reference #	Description
72201697	5.5 mm FOOTPRINT PK Suture Anchor
72201825	5.5 mm FOOTPRINT PK Suture Anchor with disposable awl
72201698	6.5 mm FOOTPRINT PK Suture Anchor
72201826	6.5 mm FOOTPRINT PK Suture Anchor with disposable awl
<b>Instruments</b>	
72201450	3.8 mm Straight Awl for use with FOOTPRINT PK, TWINFIX® PK FT and KINSA® RC Anchors, reusable
72201915	3.8 mm Tapered Awl, reusable (gold awl)
72200867	Mallet with nylon ends
72200879	Replacement end caps for mallet (set of 2)
72201707	Spade Drill, 4.5 mm for use in hard bone with the FOOTPRINT PK 5.5 mm anchor and the TWINFIX FT 5.5 mm Anchor
72201708	Spade Drill, 5.5 mm for use in hard bone with the FOOTPRINT PK 6.5 mm anchor and the TWINFIX FT 6.5 mm Anchor
72201899	Disposable Tension Tuner

## Rotator Cuff Soft Tissue Fixation – Non-absorbable Polymer Anchors

### KINSA<sup>®</sup> RC Suture Anchor

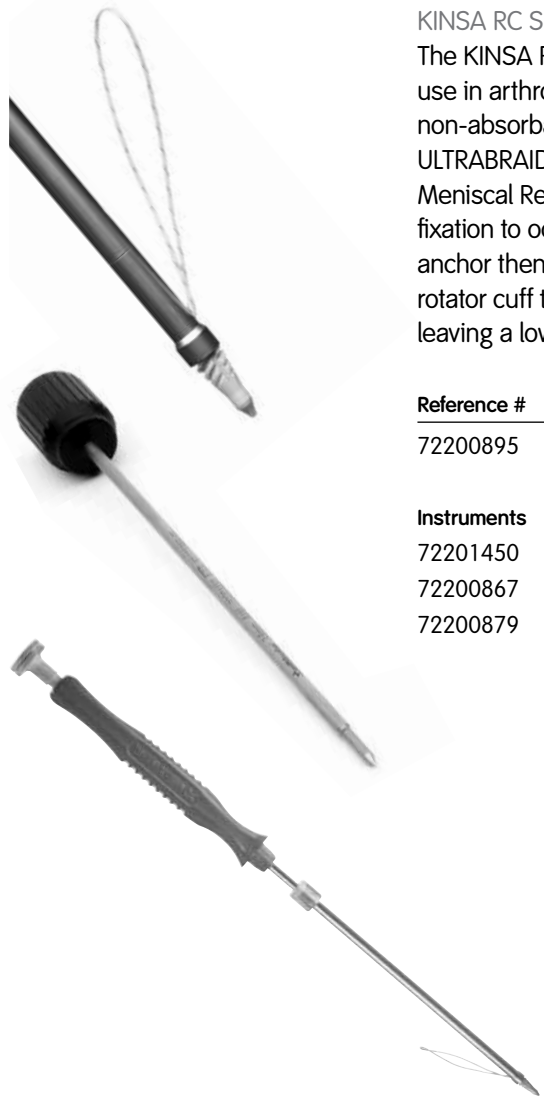

#### KINSA RC Suture Anchor

The KINSA RC Suture Anchor, 5.5 mm combination tap-in and screw-in design, is for use in arthroscopic rotator cuff procedures. Made from radiolucent high strength non-absorbable PEEK-OPTIMA<sup>®</sup> polymer from Invibio<sup>®</sup>, the anchor is preloaded with ULTRABRAID<sup>®</sup> COBRAID suture. A self-locking, sliding knot, based on the FAST-FIX<sup>®</sup> Meniscal Repair System technology, is contained within the anchor allowing secure fixation to occur without tying any knots. The design allows surgeons to insert the anchor then manually control exactly how much tension they wish to place across the rotator cuff tissue with tactile feedback. A suture loop surrounding the tissue is reduced, leaving a low profile repair with no knot stack on top of the cuff.

Reference #	Description
72200895	KINSA RC Suture Anchor, sterile

#### Instruments

72201450	3.8 mm Straight Awl, disposable
72200867	Mallet with nylon ends
72200879	Replacement nylon end caps for mallet (set of 2)



## Instability Soft Tissue Fixation

### BIORAPTOR<sup>®</sup> CURVED and OSTEORAPTOR<sup>®</sup> CURVED Suture Anchors and Guide System



The BIORAPTOR Curved and OSTEORAPTOR Curved Suture Anchors and Guide System are designed specifically to manage the surgical challenges of arthroscopic instability repair.

#### Optimal Anchor Placement

Curved drill guides with a 25° distal bend improve the trajectory of drilling and optimize anchor placement in the glenoid\*

#### Increased Access

- Anchors can be placed confidently in the most inferior aspect of the glenoid without the need to compromise the subscapularis tendon†
- The Curved Guide System removes the need to create additional working portals to access the repair site of a SLAP lesion†

#### Suture Anchor Flexibility

Achieve secure fixation from a choice of materials and sizes when using the BIORAPTOR 2.3 mm PK or OSTEORAPTOR 2.3 mm PLLA-HA or OSTEORAPTOR 2.9 mm PLLA-HA, preloaded on flexible inserters with high-strength ULTRABRAID<sup>®</sup> Suture



Reference #	Description
72203280	2.3 mm BIORAPTOR Curved PK Suture Anchor, with one ULTRABRAID (#2) Suture (COBRAID-black)
72203281	2.3 mm BIORAPTOR Curved PK Suture Anchor, with one ULTRABRAID (#2) Suture (COBRAID-blue)
72203290	2.3 mm OSTEORAPTOR Curved Suture Anchor, with one ULTRABRAID (#2) Suture (COBRAID-blue)
72203291	2.3 mm OSTEORAPTOR Curved Suture Anchor, with one ULTRABRAID (#2) Suture (COBRAID-black)
72203424	2.9 mm OSTEORAPTOR Curved Suture Anchor, with one ULTRABRAID (#2) Suture (blue)
72203423	2.9 mm OSTEORAPTOR Curved Suture Anchor, with two ULTRABRAID (#2) Sutures (blue, COBRAID-blue)

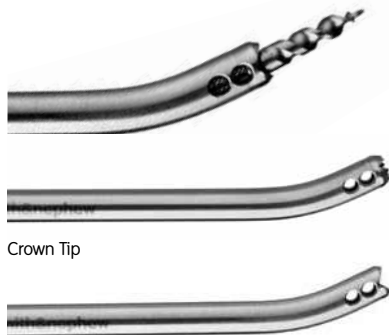

Crown Tip

Fishmouth Tip

#### Instruments

72203156	Curved Drill Guide for 2.3 mm Curved Suture Anchors – Crown Tip
72203298	Curved Drill Guide for 2.3 mm Curved Suture Anchors – Fishmouth Tip
72203459	Curved Drill Guide for 2.3 mm Curved Suture Anchors – Reverse Fishmouth Tip
72203159	Flexible Obturator for 2.3 mm Curved Suture Anchor System – Blunt
72203460	Flexible Obturator for 2.3 mm Curved Suture Anchor System – Trocar Tip
72203160	Flexible Drill for 2.3 mm Curved Suture Anchor System
72203372	Curved Drill Guide for 2.9 mm Curved Suture Anchors – Crown Tip
72203373	Curved Drill Guide for 2.9 mm Curved Suture Anchors – Fishmouth Tip
72203484	Curved Drill Guide for 2.9 mm Curved Suture Anchors – Reverse Fishmouth Tip
72203374	Flexible Obturator for 2.9 mm Curved Suture Anchor System – Blunt
72203485	Flexible Obturator for 2.9 mm Curved Suture Anchor System – Trocar Tip
72203375	Flexible Drill for 2.9 mm Curved Suture Anchor System

\* Data on file at Smith & Nephew, ITR-15001065, 2011

† Data on file at Smith & Nephew, ITR-4616, 2011

## Instability Soft Tissue Fixation – Non-absorbable Polymer Anchors

### BIORAPTOR® 2.3 Suture Anchors



#### BIORAPTOR 2.3 Suture Anchor

The BIORAPTOR 2.3 PK Suture Anchor is a small diameter anchor for shoulder, hip and small joint repairs. Made with radiolucent high strength PEEK-OPTIMA® polymer from Invibio®, the anchor includes one pre-loaded ULTRABRAID® suture. It also features the TWINFIX® style handle inserter with depth stop. The instrumentation makes it easier to maneuver to any location inside the joint, so the repair can be positioned exactly where needed.

Reference #	Description
72201541	2.3 mm BIORAPTOR PK Suture Anchor with one ULTRABRAID #2 (COBRAID-blue) suture, sterile
72201542	2.3 mm BIORAPTOR PK Suture Anchor with one ULTRABRAID #2 (COBRAID-black) suture, sterile
72201543	2.3 mm BIORAPTOR PK Suture Anchor with one ULTRABRAID #2 (white) suture, sterile

#### Instruments

72201105	Inline Drill Guide – Fishmouth Tip
72201106	Inline Obturator – Blunt Tip
72201107	Inline Obturator – Cannulated
72201108	Spade Drill Bit for 2.3 mm anchor
72201110	Inline Drill Guide – Spike Tip
72201111	Inline Drill Guide – Crown Tip
72201112	Inline Obturator – Trocar Tip
7205395	Guide Wire, Nitinol, 1.2 x 45L, non-sterile (3 per package)
72200867	Mallet with nylon ends
72200879	Replacement nylon end caps for mallet (set of 2)
72201824	Twist tip drill bit for 2.3 mm BIORAPTOR Twist Drill for 2.3 mm anchor

## Instability Soft Tissue Fixation – Suture Anchors

### BIORAPTOR® Knotless Suture Anchors

The BIORAPTOR Knotless Suture Anchor allows surgeons to control anchor tension in labral repairs post anchor insertion. Unlike other instability anchors, our knotless anchors do not rely on a bone-anchor interface for proper final fixation or suture security. Designed with an inner plug, the tension-ability and security of our sutures lies within the interior of the anchor.

#### Key Performance Characteristics

##### Independent Suture Tensioning

Our knotless anchor design gives surgeons the ability to tension the suture after anchor implantation. The inner, locking plug design captures the suture within the anchor.

##### Surgeon-controlled Tissue Shift

Achieve desired tissue shift with a solution that puts the surgeon in control. With the BIORAPTOR Knotless anchor, calculated tissue shift occurs after anchor implantation, similar to that of traditional knotted anchors.

##### May save time while protecting the joint

By eliminating the knot-tying step, surgeons may save time with less procedural steps and benefit from a solution that minimizes the risk of intra-articular damage due to knot stacks



Reference #	Description
72202403	BIORAPTOR Knotless Anchor
<b>Instruments</b>	
72201395	Inline Drill Bit 2.9 mm
72201388	Inline Drill Guide – Spiked Tip
72201389	Inline Drill Guide – Fishmouth Tip
72201390	Inline Drill Guide – Crown Tip
72201391	Inline Drill Guide – Offset Fishmouth Tip
72201392	Inline Obturator – Blunt Tip
72201393	Inline Obturator – Cannulated
72201394	Inline Obturator – Trocar Tip
72202404	Twist Drill, 2.9 mm Inline
72200867	Mallet with nylon ends
72200879	Replacement nylon end caps for mallet (set of 2)

#### Suture Passing

ACCU-PASS® Disposable Suture Shuttles,  
#1 Monofilament 48" included

Reference	Description
7210423	ACCU-PASS 45°, left, sterile
7210424	ACCU-PASS 45°, right, sterile
7210425	ACCU-PASS 45°, upbend, sterile
7210426	ACCU-PASS Straight, sterile
72200419	ACCU-PASS 70°, upbend, sterile
72201361	ACCU-PASS Monofilament, size #1, single package, sterile (10 per box)

#### Sutures

ULTRABRAID® High Strength Suture

Reference	Description
72200886	ULTRABRAID #2 white suture, 38", single package, sterile (10 per box)
72200887	ULTRABRAID #2 COBRAID suture, 38", single package, sterile (10 per box)

## Instability Soft Tissue Fixation – Suture Anchors

### OSTEORAPTOR<sup>®</sup> 2.3 Suture Anchors



These knotted anchors incorporate the natural biocompatibility of hydroxyapatite (HA), a calcium phosphate similar to the mineral found in bone. They are available in sizes that allow surgeons to position repairs precisely and are preloaded with high-strength ULTRABRAID<sup>®</sup> Suture.



Reference	Description
72201991	OSTEORAPTOR 2.3 Suture Anchor with one ULTRABRAID #2 Suture (white)
72201992	OSTEORAPTOR 2.3 Suture Anchor with one ULTRABRAID #2 Suture (COBRAID-black)
72201993	OSTEORAPTOR 2.3 Suture Anchor with one ULTRABRAID #2 Suture (COBRAID-blue)

#### Instruments

72201105	Inline Drill Guide – Fishmouth Tip
72201110	Inline Drill Guide – Spike Tip
72201111	Inline Drill Guide – Crown Tip
72201824	Twist Drill Bit for 2.3 anchor
72201108	Spade Drill Bit for 2.3 anchor
72201106	Inline Obturator – Blunt Tip
72201107	Inline Obturator – Cannulated, Blunt Tip
72201112	Inline Obturator – Trocar Tip
72202890	Twist Drill 2.45 mm

## Instability Soft Tissue Fixation – Suture Anchors

### OSTEORAPTOR<sup>®</sup> 2.9 Suture Anchors



These knotted anchors incorporate the natural biocompatibility of hydroxyapatite (HA), a calcium phosphate similar to the mineral found in bone. They are available in sizes that allow surgeons to position repairs precisely and are preloaded with high-strength ULTRABRAID<sup>®</sup> Suture.

Reference	Description
72202165	OSTEORAPTOR 2.9 Suture Anchor with one ULTRABRAID #2 Suture (white)
72201994	OSTEORAPTOR 2.9 Suture Anchor with one ULTRABRAID #2 Suture (COBRAID-blue)
72201995	OSTEORAPTOR 2.9 Suture Anchor with two ULTRABRAID #2 Sutures (white/COBRAID-blue)
72201996	OSTEORAPTOR 2.9 Suture Anchor with two ULTRABRAID #2 Sutures (white/COBRAID-black)



#### Instruments

72201389	Inline Drill Guide – Fishmouth Tip
72201388	Inline Drill Guide – Spike Tip
72201390	Inline Drill Guide – Crown Tip
72201391	Inline Drill Guide – Offset Fishmouth Tip
72201395	Inline Spade Drill Bit
72201918	Inline Spade Drill Bit 2.7 mm for soft bone
72201392	Inline Obturator – Blunt Tip
72201393	Inline Obturator – Cannulated, Blunt Tip
72201394	Inline Obturator – Trocar Tip
72202404	Inline Twist Drill Bit

# Instability Soft Tissue Fixation – Absorbable Polymer Anchors

## BIORAPTOR<sup>®</sup> 2.9 Suture Anchors

### BIORAPTOR 2.9 Suture Anchors

The BIORAPTOR 2.9 Suture Anchor is the secure solution for bioabsorbable fixation. With its cutting edge design and simple “push-in” procedure, BIORAPTOR offers a flexible surgical technique for reliable and effective instability repairs.

An improved eyelet design accommodates either one or two preloaded sutures, resulting in excellent suture sliding capability, even in the most challenging conditions, while the anchor’s unique rib shape provides superior pullout strength. BIORAPTOR is available with either DURABRAID<sup>®</sup> or ULTRABRAID<sup>®</sup> suture.

Reference	Description
72200783	2.9 mm BIORAPTOR Suture Anchor with two #2 preloaded DURABRAID sutures, sterile
72200774	2.9 mm BIORAPTOR Suture Anchor with one #2 preloaded ULTRABRAID COBRAID suture, sterile
72200689*	2.9 mm BIORAPTOR Suture Anchor with one #2 preloaded ULTRABRAID COBRAID suture, sterile, Suture Anchor Pack (3 per box)
72200775	2.9 mm BIORAPTOR Suture Anchor with two #2 preloaded ULTRABRAID sutures†, sterile
72200690*	2.9 mm BIORAPTOR Suture Anchor with two #2 preloaded ULTRABRAID sutures†, sterile, Suture Anchor Pack (3 per box)

### Instruments

72201395	Inline Drill Bit 2.9 mm, suitable for use with KINSA anchor and BIORAPTOR 2.9 mm anchors
72201918	Inline Drill Bit 2.7 mm, suitable for use with the BIORAPTOR 2.9 mm anchors (for soft bone)
72201388	Inline Drill Guide – Spiked Tip
72201389	Inline Drill Guide – Fishmouth Tip
72201390	Inline Drill Guide – Crown Tip
72201391	Inline Drill Guide – Offset Fishmouth Tip
72201392	Inline Obturator – Blunt Tip
72201393	Inline Obturator – Cannulated
72201394	Inline Obturator – Trocar Tip
72201144	3.0 mm T-Handle (manual) Drill bit with depth stop for BIORAPTOR 2.9 mm anchor, not for use with drill guides listed above
72202404	Twist Drill, 2.9 mm Inline
72200867	Mallet with nylon ends
72200879	Replacement nylon end caps for mallet (set of 2)

† One ULTRABRAID white suture and one ULTRABRAID COBRAID suture

\* US only

## Instability Soft Tissue Fixation – Absorbable Polymer Anchors

### BIORAPTOR® 2.9 AB Suture Anchor with Needles

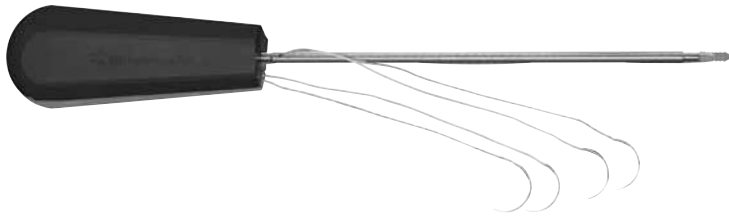

#### BIORAPTOR 2.9 AB Suture Anchor with Needles

BIORAPTOR Suture Anchors provide a reliable soft-tissue repair solution for shoulder joint instability repairs. First designed for arthroscopic repair techniques, BIORAPTOR suture anchors are now available with needles to accommodate open and mini-open repair procedures. Available in 2.9 mm diameter, the anchor includes pre-loaded ULTRABRAID® Suture. Each end of the suture includes a swaged-on, 1/2 circle cutting needle, which is housed behind a protective pull-away panel in the inserter handle.

Reference	Description
72201702	2.9 mm BIORAPTOR AB Suture Anchor with two ULTRABRAID #2 sutures with needles (white, COBRAID-blue)
<b>Instruments</b>	
72201705	2.9 mm slotted drill guide
72200867	Mallet with nylon ends
72200879	Replacement nylon end caps for mallet (set of 2)
72201395	Inline Drill Bit 2.9 mm
72201918	Inline Drill Bit 2.7 mm for soft bone
72202404	Inline Drill Bit 2.9 mm, Twist Drill

## Instability Soft Tissue Fixation – Non-absorbable Polymer Anchors

### BIORAPTOR<sup>®</sup> 2.3 PK Suture Anchor with Needles

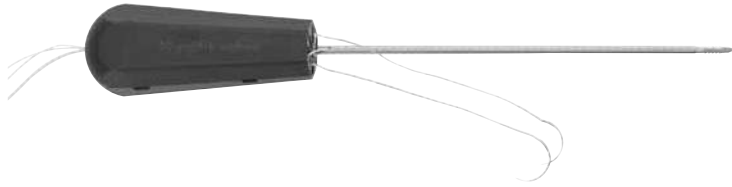

#### BIORAPTOR 2.3 PK Suture Anchor with Needles

BIORAPTOR Suture Anchors provide a reliable soft-tissue repair solution for shoulder joint instability repairs. First designed for arthroscopic repair techniques, BIORAPTOR suture anchors are now available with needles to accommodate open and mini-open repair procedures. Available in 2.3 mm diameter, the anchor includes ULTRABRAID<sup>®</sup> Suture. Each end of the suture includes a swaged-on, 1/2 circle cutting needle, which is housed behind a protective pull-away panel in the inserter handle.

Reference #	Description
72201703	2.3 mm BIORAPTOR PK Suture Anchor with one ULTRABRAID #2 sutures with needles (COBRAID-blue)
72201704	2.3 mm BIORAPTOR PK Suture Anchor with one ULTRABRAID #2 sutures with needles (COBRAID-black)

#### Instruments

72201706	2.3 mm Slotted Drill Guide
72201108	Inline Drill Bit, for use with BIORAPTOR 2.3 mm anchors
72200867	Mallet with nylon ends
72200879	Replacement nylon end caps for mallet (set of 2)



## Instability Soft Tissue Fixation – Metallic Anchors

### TWINFIX<sup>®</sup> Ti 3.5 and TWINFIX Ti 2.8 Suture Anchors

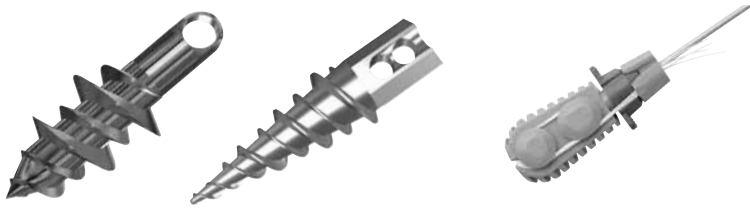

#### TWINFIX Ti 3.5 and TWINFIX Ti 2.8 Suture Anchor

The unique thread design of the TWINFIX Ti 3.5 anchor and the TWINFIX Ti 2.8 anchor provides extraordinary pullout strength and easy insertion in all bone conditions, and provides superior solutions to the orthopaedic surgeon. Multiple suture options can save costs by reducing the number of anchors per procedure. The multiple point fixation also provides a stronger repair at the reattachment site.

#### TWINFIX Ti 3.5 with DURABRAID<sup>®</sup> suture

Reference #	Description
72200763*	3.5 mm TWINFIX Ti Suture Anchor with two #2 preloaded DURABRAID sutures, sterile
7210302	3.5 mm TWINFIX Ti Suture Anchor with two #2 preloaded DURABRAID sutures with needles, sterile

#### TWINFIX Ti 2.8 with DURABRAID Suture

Reference #	Description
72200762*	2.8 mm TWINFIX Ti Suture Anchor with one #2 preloaded DURABRAID suture, sterile
72200761	2.8 mm TWINFIX Ti Suture Anchor with one #1 preloaded DURABRAID suture, sterile

#### TWINFIX Ti 3.5 with ULTRABRAID<sup>®</sup> Suture

Reference #	Description
72200752	3.5 mm TWINFIX Ti Suture Anchor with two #2 preloaded ULTRABRAID sutures, sterile
7210707	3.5 mm TWINFIX Ti Suture Anchor with two #2 preloaded ULTRABRAID sutures with needles <sup>†</sup> , sterile
72200686 <sup>‡</sup>	3.5 mm TWINFIX Ti Suture Anchor with two #2 preloaded ULTRABRAID (3 per box) sutures, sterile, Suture Anchor Pack
72200760 <sup>‡</sup>	3.5 mm TWINFIX Ti Suture Anchor with one #2 preloaded ULTRABRAID sutures, sterile, no needles (5 per box)

#### TWINFIX Ti 2.8 with ULTRABRAID Suture

Reference #	Description
72200750	2.8 mm TWINFIX Ti Suture Anchor with one #2 preloaded ULTRABRAID suture, sterile
72200685 <sup>‡</sup>	2.8 mm TWINFIX Ti Suture Anchor with one #2 preloaded ULTRABRAID (3 per box) suture, sterile, Suture Anchor Pack
72200749 <sup>‡</sup>	2.8 mm TWINFIX Ti Suture Anchor with one #2 preloaded ULTRABRAID suture, sterile, no needles (5 per box)

#### TWINFIX Ti 2.8 and 3.5 Instruments

Reference #	Description
7209502	2.5 mm Drill for TWINFIX Ti 3.5 mm and 5.0 mm anchor
7209500	6" Drill Guide for Glenoid Placement – 6" x 3.5 mm Spiked Tip for TWINFIX Ti 2.8 mm and 3.5 mm anchor
7209506	1.8 mm Drill for TWINFIX Ti 2.8 mm anchor
7209503	Awl for TWINFIX Ti 2.8 mm anchor

# Instability System

## ELITE<sup>◊</sup> PREMIUM Instability System



### ELITE PREMIUM Instability System

The ELITE PREMIUM Instability System offers arthroscopic shoulder surgeons the ability to house our wide array of innovative endoscopic instruments in sleek, comprehensive trays with customizable areas.

- Comprehensive and customizable
- Sufficient pin mat area
- Single layers of instrumentation

Reference #	Description
72202504	ELITE PREMIUM Instability System
<b>System includes</b>	
72201389	2.9 mm Inline Drill Guide – Fishmouth Tip
72201388	2.9 mm Inline Drill Guide – Spiked Tip
72201390	2.9 mm Inline Drill Guide – Crown Tip
72201391	2.9 mm Inline Drill Guide – Offset Fishmouth Tip
72201393	2.9 mm Inline Drill Guide – Cannulated Blunt Tip
72201394	2.9 mm Inline Drill Guide – Trocar Tip
72201392	2.9 mm Inline Drill Guide – Blunt Tip
72201395	2.9 mm Inline Spade Drill Bit
72200867	Mallet with nylon ends
72201105	2.3 mm Inline Drill Guide – Fishmouth Tip
72201110	2.3 mm Inline Drill Guide – Spiked Tip
72201111	2.3 mm Inline Drill Guide – Crown Tip
72201108	2.6 mm Spade Drill Bit for 2.3 mm anchor
72201112	2.3 mm Inline Obturator – Trocar Tip
72201106	2.3 mm Inline Obturator – Blunt Tip
72201107	2.3 mm Inline Obturator – Cannulated Blunt Tip
72202044	Instability System Sterilization Tray and Lid

## Instability Soft Tissue Fixation – Non-absorbable Polymer Anchors

### KINSA<sup>®</sup> Suture Anchor

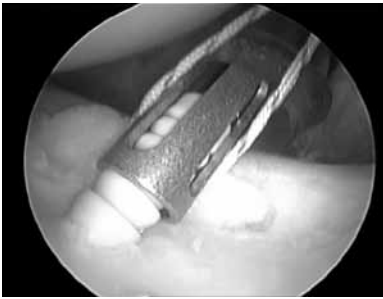

#### KINSA Suture Anchor

The KINSA Suture Anchor, 2.9 mm, is designed for use in arthroscopic glenohumeral joint stability procedures. It is a tap-in anchor made from radiolucent high-strength non-absorbable PEEK-OPTIMA<sup>®</sup> polymer from Invibio<sup>®</sup>, the anchor is preloaded with ULTRABRAID<sup>®</sup> COBRAID suture and loaded onto a disposable inserter.

A self-locking, sliding knot, based on the Smith & Nephew FAST-FIX<sup>®</sup> Meniscal Repair System, is contained in the anchor allowing secure fixation without tying any knots. The design allows the tension placed on the tissue for fixation to be totally independent of the anchor depth. A suture loop reduces the tissue, leaving a low profile repair with no knot stack in the joint.



Reference #	Description
72200239	KINSA Suture Anchor, sterile

#### Instruments

72201395	Inline Drill Bit 2.9 mm, suitable for use with KINSA anchor and BIORAPTOR <sup>®</sup> 2.9 anchors
72201388	Inline Drill Guide – Spiked Tip
72201389	Inline Drill Guide – Fishmouth Tip
72201390	Inline Drill Guide – Crown Tip
72201391	Inline Drill Guide – Offset Fishmouth Tip
72201392	Inline Obturator – Blunt Tip
72201393	Inline Obturator – Cannulated
72201394	Inline Obturator – Trocar Tip
72200867	Mallet with nylon ends
72200879	Replacement nylon end caps for mallet (set of 2)
72201144*	3.0 mm T-Handle (manual) Drill Bit, not for use with drill guides listed above

\* Item shown

## Instability Soft Tissue Fixation – Tissue Tacks

### SURETAC<sup>®</sup> Instrumentation Components



#### SURETAC Drills

Reference #	Description
013353	6.0 mm SURETAC Guide Wire, .039" x 15" (.1 cm x 38 cm)

#### Optional Components

Can be used with REF 013381



Reference #	Description
014779*	Cannulated Tissue Tensioner, .077 I.D. (2.0 mm)
011030	Tissue Tensioner, non-cannulated
72201661	ELITE <sup>®</sup> PREMIUM Knife Rasp



#### SURETAC IXC Guide Wires

Package of 6, non-sterile.

Reference #	Implant Size	Material Type	Diameter x Length
014581	6.0 mm	Nitinol	.039" x 6.8" (.1 cm x 17 cm)
014568	6.0 mm	Stainless	.039" x 6.8" (.1 cm x 17 cm)
014582	8.0 mm	Nitinol	.062" x 6.8" (.15 cm x 17 cm)
014569	8.0 mm	Stainless	.062" x 6.8" (.15 cm x 17 cm)

## Biceps Tenodesis Repair

### BICEPTOR<sup>®</sup> Tenodesis System



#### BICEPTOR Tenodesis System

Surgeons have come to rely on the Smith & Nephew line of innovative products to bring an updated approach to many surgeries. The BICEPTOR Tenodesis System was created to do just that. Our system was designed with your time in mind, to be easy and to reduce guesswork in your arthroscopic or mini-open repair.

- Fewer procedural steps mean more efficient use of your time
- No whipstitching of tendon means a sutureless repair
- Strong pullout strength means confidence in procedure
- Ability to cut tendon in last step means less guesswork and more control over tensioning

Reference #	Description
72202302	BICEPTOR Tenodesis System

#### System includes

72202190	BICEPTOR Driver
72202193	7 mm Tendon Fork (initially labeled Small)
72202192	8 mm Tendon Fork (initially labeled Medium)
72202191	9 mm Tendon Fork (initially labeled Large)
72202194	Bi-grip Pin Puller
72202198	7.0 mm Endoscopic Drill XL
72202297	8.0 mm Endoscopic Drill XL
72202298	9.0 mm Endoscopic Drill XL
72202195	7.0 mm BICEPTOR Tap
72202196	8.0 mm BICEPTOR Tap
72202197	9.0 mm BICEPTOR Tap
72202202	ELITE <sup>®</sup> Premium Biceps Tenodesis Tray

# Biceps Tenodesis Repair

## BICEPTOR<sup>®</sup> Tenodesis System





### BICEPTOR BIOSURE<sup>®</sup> PK Screws

Reference #	Description
72202636	7 mm x 25 mm BICEPTOR BIOSURE PK Screw
72202637	8 mm x 25 mm BICEPTOR BIOSURE PK Screw
72202638	9 mm x 25 mm BICEPTOR BIOSURE PK Screw
72202283	7 mm x 15 mm BICEPTOR BIOSURE PK Screw
72202284	8 mm x 15 mm BICEPTOR BIOSURE PK Screw
72202285	9 mm x 15 mm BICEPTOR BIOSURE PK Screw
72202189	1.5 mm Tendon Drill Pin
7208678	2.4 mm Drill Tip Pin

### Repair Kits

Reference #	Description
72202299	BICEPTOR Kit, 7 x 15 mm BIOSURE <sup>®</sup> Screw
72202300	BICEPTOR Kit, 8 x 15 mm BIOSURE Screw
72202301	BICEPTOR Kit, 9 x 15 mm BIOSURE Screw
72202357	BICEPTOR Kit, 7 x 25 mm BIOSURE Screw
72202358	BICEPTOR Kit, 8 x 25 mm BIOSURE Screw
72202359	BICEPTOR Kit, 9 x 25 mm BIOSURE Screw

NOTE: Repair kit includes PEEK BIOSURE Interference screw, 1.5 mm tendon drill pin and 2.4 mm drill tip pin

Reference #	Description
 72202508	7 mm Tendon Fork with tines extended 3 mm
 72202509	8 mm Tendon Fork with tines extended 3 mm
 72202510	9 mm Tendon Fork with tines extended 3 mm
 72202513	9 mm Tendon Fork, offset
 72202514	10 mm Tendon Fork, standard length

## Suture Fixation

### ULTRABRAID<sup>®</sup> High Strength Suture



#### ULTRABRAID High Strength Suture

The confidence of a strong, secure shoulder repair begins with ULTRABRAID Suture. This non-absorbable suture is composed of a special ultra high molecular weight (UHMW) polyethylene fiber and features a unique braid configuration. As a result, ULTRABRAID Suture offers special advantages over traditional polyester suture, including higher knot breaking strength, increased lubricity, and a higher resistance to fraying. ULTRABRAID Suture is preloaded on many TWINFIX<sup>®</sup> Suture Anchors (not on TWINFIX PMR 5.0) that have #2 sutures. It is also available in an individual, sterile presentation, in either white or COBRAID.

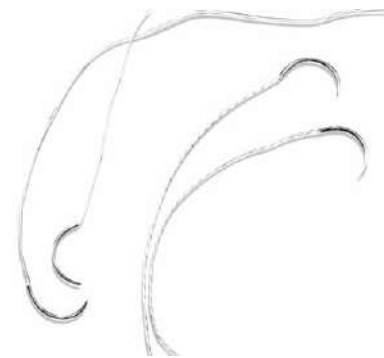

Reference #	Description
7210914	ULTRABRAID #2 white suture and needle assembly, 38", (10 per box), sterile
7210915	ULTRABRAID #2 COBRAID suture and needle assembly, 38", (10 per box), sterile
7211080	ULTRABRAID #2 white suture and needle assembly, 38", sterile
7211081	ULTRABRAID #2 COBRAID suture and needle assembly, 38", sterile
72200886	ULTRABRAID #2 white suture, 38", (10 per box), sterile
72200887	ULTRABRAID #2 COBRAID suture, 38", (10 per box), sterile
72202465	ULTRABRAID #2 COBRAID-blue suture 38", (10 per box), sterile

## Patient Positioning

### SPIDER2 and SPIDER Limb Positioners

#### Ideal positioning for arthroscopic procedures.

Offering instantaneous repositioning, the SPIDER2 Limb Positioner delivers exceptional control of abduction, rotation and forward flexion in beach chair and lateral decubitus positions with both forward and downward traction. Building from the success of the SPIDER Limb Positioner, new features take patient positioning to an entirely new level and enable the SPIDER2 positioner to do the repositioning work for you.

#### Distal activation switch can be easily affixed to patient or accessory.

Switch is attached to sterile drape via sticky foam backing – simply remove and adhere on a convenient location and apply a small amount of pressure to activate and move the SPIDER2 positioner.

#### The SPIDER2 and SPIDER Limb Positioners are ideal for:

**Shoulder** – used in Beach Chair and lateral positions for arthroscopic rotator cuff, instability, total shoulder and humeral nailing.

**Knee** – used for arthroscopy or arthroplasty procedures.

**Hip** – used with fracture table to provide traction.

**Elbow** – used for supine and lateral procedures allowing excellent access and repositioning of the arm.

**Wrist** – used for wrist, hand and distal forearm procedures with the ability to pronate, supinate and deviate.

**Ankle** – used for supine ankle arthroscopy providing traction and excellent access.

Reference #	Description
72203299	SPIDER2 Limb Positioner
72203300	Switch Drape (case of 20)
72203301	SPIDER2 Battery Pack
7210570	Piggy Back Connector (2 per box, required for all sterile procedures)





## Patient Positioning

### SPIDER2 Limb Positioner and Accessories

#### SPIDER2 System (T-MAX)

Reference #	Description
72203565	T-MAX System
<b>System includes</b>	
7210551	T-MAX Shoulder Positioner
7210552	Adjustable Arm Board
7210553	T-MAX Cart
7210554	Square Rail Clamps (2 per box)
7210555	Intubation Pad
72203299	SPIDER2 Limb Positioner
7210570	Piggy Back Connector (2 per box)
7210571	Shoulder Connection Bar (2 per box)
7210576	Lateral Shoulder Connection Bar (2 per box)
7210577	Traction Accessory
72200918	SPIDER Cart
72203300	Switch Drape (20 per box)
72203301	Battery Pack

#### SPIDER2 System (Beach Chair)

Reference #	Description
72203516	Beach Chair System
<b>System includes</b>	
72203299	SPIDER2 Limb Positioner
7210570	Piggy Back Connector (2 per box)
72200918	SPIDER Cart
72203300	Switch Drape (20 per box)
7210571	Shoulder Connection Bar (2 per box)

#### SPIDER2 System (Lateral Decubitus)

Reference #	Description
72203517	Lateral Decubitus System
<b>System includes</b>	
72203299	SPIDER2 Limb Positioner
7210570	Piggy Back Connector (2 per box)
7210576	Lateral Shoulder Connection Bar (2 per box)
7210577	Traction Accessory
72200918	SPIDER Cart
72201428	Lateral JACK
72202466	Lateral JACK Sterile Cover (25 per box)
72203300	Switch Drape (20 per box)
<b>Miscellaneous</b>	
Reference #	Description
72200918	SPIDER Cart
7210553	T-MAX Cart

#### Disposables

Reference #	Description
7210573	Shoulder Stabilization Kit, disposable, sterile (12 per case)
7210559	Disposable Face Mask, disposable (8 per case)

## Patient Positioning

### SPIDER2 and SPIDER Limb Positioners and Accessories



The original SPIDER Limb Positioner combines strength and flexibility to provide optimal intraoperative positioning for upper and lower extremity procedures.

#### SPIDER System (Beach Chair)

Reference #	Description
7210994	SPIDER System (Beach Chair)
<b>System includes</b>	
7210569	SPIDER Limb Positioner
7210570	Piggy Back Connector (2 per box, required for 7210569)
7210571	Shoulder Connection Bar (2 per box)
72200918	SPIDER Cart

#### SPIDER System (Lateral Decubitus)

Reference #	Description
7210995	SPIDER System (Lateral Decubitus)
<b>System includes</b>	
7210569	SPIDER Limb Positioner
7210570	Piggy Back Connector, (2 per box required for 7210569)
7210576	Lateral Shoulder Connection Bar (2 per box)
7210577	Traction Accessory, two included in system
72200918	SPIDER Cart
72201428	Lateral JACK
72202466	Lateral JACK Sterile Cover (25 per box)

#### SPIDER Limb Positioner and Accessories

Note: all SPIDER Limb Positioner Accessories are interchangeable with the SPIDER2 Limb Positioner on previous pages.

Reference #	Description
7210569	SPIDER Limb Positioner
7210570	Piggy Back Connector (2 per box, required for 7210569)
7210571	Shoulder Connection Bar (2 per box)
7210572	Elbow Connection Bar
7210573	Shoulder Stabilization Kit, disposable, sterile (12 per box)
7210574	Elbow Stabilization Kit, disposable, sterile (12 per box)
7210576	Lateral Shoulder Connection Bar (2 per box)
7210577	Traction Accessory
72200917	SPIDER Limb Positioner, Japan and UK
72200918	SPIDER Cart
7210749	90° Connector
72201428	Lateral JACK
72202466	Lateral JACK Sterile Cover (25 per box)

## Patient Positioning

### T-MAX System (beach chair positioner)



The T-MAX Shoulder Positioner is a patient positioning system that provides arthroscopy surgeons with the full range of features they need.

**Exposure** – shoulder pad slides laterally, providing maximum exposure to the operative shoulder

**Access** – patient can be positioned closer to the side of the OR table to allow maximum accessibility

**Adjustability** – hydraulic assist mechanism allows any angle from sitting to supine (0-90°)

**Versatility** – the T-MAX attaches to most OR tables and is designed for intraoperative use of radiographs and fluoroscopy

Reference #	Description
7210996	T-MAX System

#### System includes

7210551	T-MAX Shoulder Positioner
7210552	Adjustable Arm Board
7210553	T-MAX Cart
7210554	Square Rail Clamps (2 per box)
7210555	Intubation Pad
7210560	Knee Bolster
72201184	Body Strap

## Patient Positioning

### T-MAX Shoulder Positioners and Accessories

#### Combination System

Reference #	Description
7210997	T-MAX and SPIDER Combination System

#### System includes

7210551	T-MAX Shoulder Positioner
7210552	Adjustable Arm Board
7210553	T-MAX Cart
7210554	Square Rail Clamps (2 per box)
7210555	Intubation Pad
7210569	SPIDER Limb Positioner
7210570	Piggy Back Connector (2 per box, required for 7210569)
7210571	Shoulder Connection Bar (2 per box)
7210576	Lateral Shoulder Connection Bar (2 per box)
7210577	Traction Accessory, two included in system
72200918	SPIDER Cart

#### T-MAX Shoulder Positioner and Accessories

Reference #	Description
7210551	T-MAX Shoulder Positioner
7210552	Adjustable Arm Board
7210553	T-MAX Cart
7210554	Square Rail Clamps (2 per box)
7210555	Intubation Pad
7210556	Gel Face Mask
7210557	Extended Lateral Support
7210558	Mask Straps (pair)
7210559	Disposable Face Mask, disposable (8 per box)
7210560	Knee Bolster
7210563	Intubation Drape Bar
7210564	Lateral Support Knobs, t-shaped (2 per box)
72200481	T-MAX, Japanese/Eschman
72200482	T-MAX, OPT
72200668	T-MAX, DE
72201185	T-MAX, MA
72203318*	Adjustable Lateral Support
72203415*	Non-operative Arm Board



\* Item shown

## Patient Positioning Components and Accessories

### T-MAX Shoulder Replacement Kits

Reference #	Description
72200483	Strut Replacement Kit
72200484	Intubation Tree Replacement Kit
72201184	Replacement Body Straps
72210558	Mask Straps (one pair)

### SPIDER Limb Positioner Replacement Kits

Reference #	Description
72200485	Air Swivel Repair Kit
72200486	Foot Pedal Replacement Kit
72200487	Distal Quick Connect Replacement Kit
72200488	Indexing Handle Replacement Kit
72201183	Universal Hose Kit (North America), 15 Ft.
72200659	SPIDER Attachment Rail

### International Connectors

Reference #	Description
7211096	JE Adapter Leg Kit (2 units)
7211097	JE Rail Clamps (2 units)
7211098	Denyers Adapter Leg Kit (2 units)
7211099	European Square Rails Clamps (2 units)
7211100	Denyers Rail Clamp (2 units)
7211104	Eschman SPIDER Shim
7211105	Japanese SPIDER Shim

## Patient Positioning

### Elbow Joint Positioners



Elbow Arthroscopy using the SPIDER Limb Positioner (supine)

Reference #	Description
7210569	SPIDER Limb Positioner
7210570	Piggy Back Connector (2 per box, required for 7210569)
7210572	Elbow Connection Bar (2 per box)
7210749	90° Connector
72200918	SPIDER Cart

#### Disposable

7210574	Elbow Stabilization Kit, sterile (12 per box)
---------	---



Western Elbow Positioner (lateral or prone)

Reference #	Description
7210575	Western Elbow Positioner

## Patient Positioning

### Disposable Kits for Shoulder Arthroscopy



Latex-free Shoulder Suspension Kit  
Sterile, disposable, latex-free, box of 6 kits.

Reference #	Description
72200195	Shoulder Suspension Kit, latex-free
	Kit includes: COBAN™ LF wrap Rope with S-Hook Arm Drape/Stockinette

## Patient Positioning

### Shoulder Traction Products



Shoulder Holder/Traction

Reference #	Description
3144	Shoulder Traction Holder, supplied with S-hook



Reference #	Description
7207340*	Shoulder Holder

**Replacement parts** (included with 7207340)

354009	S-hook
354001	Traction Rope
354008	Slide Bar
8104983	Rail conversion kit for Maquet Bed Rails



## Access Disposable Cannulas

### CLEAR-TRAC<sup>®</sup> COMPLETE Disposable Cannula System



#### CLEAR-TRAC COMPLETE Disposable Cannula System

The CLEAR-TRAC COMPLETE Cannula System is enhanced with a robust triple-seal design and an integrated suture management system. These new features, combined with the many existing facets from the previous generation, provide a truly comprehensive cannula solution.

- Integrated triple-seal design
- Suture management system
- Removable cannula cap
- Tall thread configuration
- Transparent polycarbonate body
- Latex-free design

#### CLEAR-TRAC COMPLETE Cannula Family (sterile, single-use, 10 per box)

Reference #	Description
72200902	8.5 mm x 90 mm Threaded Cannula, with disposable obturator, green, sterile
72200903	8.5 mm x 72 mm Threaded Cannula, with disposable obturator, green, sterile
72200904	8.5 mm x 45 mm Threaded Cannula, with disposable obturator, green, sterile
72200905	7.0 mm x 72 mm Threaded Cannula, with disposable obturator, grey, sterile
72200906	7.0 mm x 72 mm Smooth Cannula, with disposable obturator, grey, sterile
72200907	5.5 mm x 72 mm Threaded Cannula, with disposable obturator, blue, sterile
72200908	5.5 mm x 45 mm Threaded Cannula, with disposable obturator, blue, sterile
72200909	4.5 mm x 72 mm Threaded Cannula, with disposable obturator, purple, sterile

#### CLEAR-TRAC COMPLETE Reusable Obturators



Reference #	Description
72200910	8.5 mm x 90 mm Reusable Obturator (4.3 mm cannulation), green
72200913	8.5 mm x 90 mm Reusable Solid Obturator, green
72200911	8.5 mm x 72 mm Reusable Obturator (4.3 mm cannulation), green
72200912	8.5 mm x 72 mm Reusable Obturator (1.5 mm cannulation), green
72200914	8.5 mm x 72 mm Reusable Solid Obturator, green
72200915	7.0 mm x 72 mm Reusable Obturator (4.3 mm cannulation), grey
72200916	7.0 mm x 72 mm Reusable Obturator (1.5 mm cannulation), grey
72201796	5.5 mm Reusable Obturator (4.3 mm cannulation), blue

#### Accessories



3801	Switching Stick, 4.3 mm, not cannulated (13" long)
------	--

## Access Disposable Cannulas

### CLEAR-TRAC<sup>®</sup> FLEXIBLE Disposable Cannula System



#### CLEAR-TRAC<sup>®</sup> FLEXIBLE Disposable Cannula System

The CLEAR-TRAC FLEXIBLE Cannula System is made from a flexible body material, it provides excellent tactile feedback to help identify structures and may reduce the risk of significant tissue damage. Enhanced with a robust triple-seal design. CLEAR-TRAC FLEXIBLE cannulas also feature an integrated suture management system.

- Integrated triple-seal design
- Suture management system
- Flexible body material
- Easy to thread, secure configuration
- Transparent body
- Capped flow port with optional disposable stopcock
- Latex-free design

#### CLEAR-TRAC FLEXIBLE Cannula Family (sterile, single-use, 10 per box)

Reference #	Description
72200424	8.0 mm x 90 mm Threaded Cannula, with disposable obturator, lime green, sterile
72200425	8.0 mm x 72 mm Threaded Cannula, with disposable obturator, lime green, sterile
72200426	8.0 mm x 72 mm Smooth Cannula, with disposable obturator, lime green, sterile
72200427	6.5 mm x 72 mm Threaded Cannula, with disposable obturator, orange, sterile
72200428	6.5 mm x 72 mm Smooth Cannula, with disposable obturator, orange, sterile
72200429	5.5 mm x 72 mm Threaded Cannula, with disposable obturator and trocar, blue, sterile
72200430	5.5 mm x 55 mm Threaded Cannula, with disposable obturator and trocar, blue, sterile
72200431	5.5 mm x 55 mm Smooth Cannula, with disposable obturator and trocar, blue, sterile
72200432	5.5 mm x 45 mm Threaded Cannula, with disposable obturator and trocar, blue, sterile
72200433	4.5 mm x 72 mm Threaded Cannula, with disposable obturator, purple, sterile

#### CLEAR-TRAC FLEXIBLE Reusable Obturators



Reference #	Description
72200899	8.0 mm x 90 mm Reusable Obturator (4.3 mm cannulation), lime green
72200900	8.0 mm x 72 mm Reusable Obturator (4.3 mm cannulation), lime green
72201796	5.5 mm Reusable Obturator (4.3 mm cannulation), blue
72201846	6.5 mm x 72 mm Reusable Obturator (4.3 mm cannulation)

#### Accessories

72200658	CLEAR-TRAC Disposable Stopcock
3801	Switching Stick, 4.3 mm, not cannulated (13" long)



## Access

### Portal Accessory System

#### Portal Accessory System

Reference #	Description
7207113	Portal Accessory System



#### System includes

013945 4.0 mm Portal Stick x 12" (30 cm) long



013948 4.0 mm Shoulder Rod x 12" (30 cm) long



013950 8.0 mm Shoulder Rod Guide, 4 mm cannulation



014820\* 8.0 mm Cannulated Obturator, 1.5 mm cannulation

014819 5.0 mm Cannulated Obturator, 1.5 mm cannulation

013334 8.0 mm Guide Wire, .062" x 15" (.15 cm x 38 cm) (6 per package)  
7207114 Sterilization Tray



#### CLEAR-TRAC<sup>®</sup> Threaded Cannula with Cannulated Obturator

Reference #	Description
7207197	CLEAR-TRAC Threaded Cannula, 10 mm I.D., 76 mm long with 4.0 mm cannulated obturator, white, contains latex Includes cannulated obturator. Single-use sterile packs (10 per box)

## Access

### Portal Accessory System

#### Shoulder Portal System

Reference #	Description
-------------	-------------

3803	Shoulder Portal System
------	------------------------

#### System includes

3175	Cannulas, 4.5 mm, without holes (2 included in system)
------	--



3176	Cannulas, 5.5 mm, without holes (2 included in system)
------	--



3801	Switching Stick, 4.3 mm, not cannulated (13" long)
------	--



3802	Switching Sleeve, 4.5 mm I.D., 5.5 mm O.D. (10" long)
------	---



2787	Wissinger Rod, 4.3 mm (overall length 11.25", shaft length 10")
------	---



#### Wissinger Set

Reference #	Description
-------------	-------------

2698	Wissinger Set
------	---------------

#### System includes

2787	Wissinger Rod, 4.3 mm (overall length 11.25", shaft length 10")
------	---

3175	Cannulas, 4.5 mm, without holes (2 included in system)
------	--

## Suture Passing Instrumentation

### ELITE<sup>®</sup> PASS Premium Arthroscopic Suture Shuttle



#### ELITE PASS Premium Arthroscopic Suture Shuttle

The ELITE PASS Premium Arthroscopic Suture Shuttle offers arthroscopic shoulder surgeons a flexible, single-handed method of passing suture through tissue without the need for additional instruments. The reusable instrument features the trusted ACUFEX<sup>®</sup> instrument design, while the disposable needle is composed of highly flexible steel, reducing the potential for breakage. The ELITE PASS design also gives surgeons the ability to pass suture through a single access portal, thus simplifying the procedure and decreasing costs for providers and patients. Bite is 10 mm thick and 10 mm deep.



Reference #	Description
7211020	ELITE PASS Premium Arthroscopic Suture Shuttle with Ratchet
7211021*	ELITE PASS Premium Arthroscopic Suture Shuttle without Ratchet
7210693	ELITE PASS Shuttle Needle, sterile (5 per box)
72201840	ELITE PASS Long Bite, with Ratchet

\* Item shown

## Suture Passing Instrumentation

### ACCU-PASS<sup>®</sup> Suture Shuttle



#### ACCU-PASS Suture Shuttle

With its single hand use design, ergonomic handle and thumb wheels, the ACCU-PASS Suture Shuttle allows for precise control of suture placement and shuttle deployment, reducing operating time and cost.

Eight different tip configurations and three shuttle loading options provide flexibility in both procedure and technique, while the solid one-piece shaft resists bending and breakage. Sterile, single patient use gives surgeons the confidence in knowing the instrument will be sharp. The system can be used with a doubled #2-0 and #0 or a single #1 and #2 monofilament suture.

Reference #	Description
7210423	ACCU-PASS 45°, left, sterile
7210424	ACCU-PASS 45°, right, sterile
7210425	ACCU-PASS 45°, upbend, sterile
7210426	ACCU-PASS Straight, sterile
7210427	ACCU-PASS Crescent, sterile
72200418	ACCU-PASS Big Curve, sterile
72200419	ACCU-PASS 70°, upbend, sterile
72201076	ACCU-PASS J-Hook, sterile
72201361	ACCU-PASS monofilament, size #1, single pack, sterile (10 per box) NOTE: #1 Monofilament 48" included

#### Bone Stitchers

Reference #	Description
⚙ 72203226	60° Bone Stitcher, long tip
⚙ 72202730	60° Bone Stitcher, short tip
⚙ 72202494	Stylet for Bone Stitcher

#### Accessories used to pass and retrieve suture arthroscopically

Reference #	Description
014617	Transporter, single use, sterile (4 per box)



## Suture Passing Instrumentation

### Reusable Suture Shuttle Instrumentation



#### ARTHRO-PIERCE® Premium Instrument System

Single-step suture passage is made simple with ARTHRO-PIERCE instruments. The low-profile, highly sharpened tip allows easy passage through tissue in order to retrieve or apply suture.

- Geometrically designed for ultimate flexibility in shoulder repair
- All surfaces electropolished and contoured for smooth passage
- Retrieve or apply suture in one easy step
- Sized to fit down a 7.6 mm cannula

Reference #	Description
7209829	ARTHRO-PIERCE Premium Instrument System

#### System includes:

7209496	ARTHRO-PIERCE Instrument, straight
7209497	ARTHRO-PIERCE Instrument, 45° right
7209498	ARTHRO-PIERCE Instrument, 45° left
7209499	ARTHRO-PIERCE Instrument, 35° up
7209182	Sterilization Tray, 13" x 9" x 6"

Reference #	Description
7210378	ARTHRO-PIERCE, straight with 12° upward bend
7210227	ARTHRO-PIERCE Instrument, 35° up with 9° upward bend
7210226	ARTHRO-PIERCE Instrument, 45° left with 12° upward bend
7210225	ARTHRO-PIERCE Instrument, 45° right with 12° upward bend
72201186*	ARTHRO-PIERCE Instrument, curved left, cigar handle
72201187*	ARTHRO-PIERCE Instrument, curved right, cigar handle

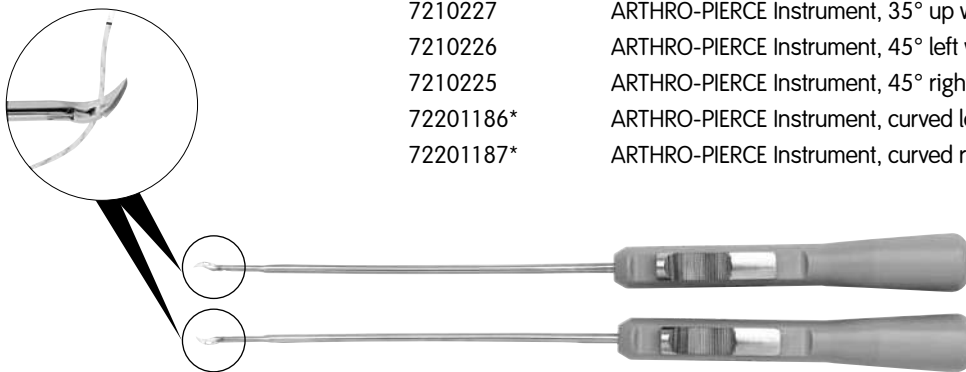

\* Item shown

## Suture Passing Instrumentation

### ELITE<sup>®</sup> CUFF STITCH<sup>®</sup> Suture Relays



#### ELITE CUFF STITCH Suture Relay

- Removes the “shuttle” out of suture passage
- Load the suture directly onto the cuff stitch and pass through the tissue in one step
- Improves suture passage
- Can be used alone or with anchors
- Offered in a variety of angles to fill any surgical need
- Reusable



Reference #	Sterile	Description
7209152		ELITE CUFF STITCH Suture Relay, straight, reusable
7209154		ELITE CUFF STITCH Suture Relay, 30° left, reusable
7209153		ELITE CUFF STITCH Suture Relay, 30° right, reusable
7209155		ELITE CUFF STITCH Suture Relay, 45° right, reusable
7209156		ELITE CUFF STITCH Suture Relay, 45° left, reusable
7209157		ELITE CUFF STITCH Suture Relay, 70° right, reusable
7209158		ELITE CUFF STITCH Suture Relay, 70° left, reusable
7209160		ELITE CUFF STITCH Suture Relay, 180° right, reusable
7209161		ELITE CUFF STITCH Suture Relay, 180° left, reusable

#### ACUFEX<sup>®</sup> Suture with Needles

Green, braided, PTFE-impregnated polyester fiber, non-absorbable, single use, sterile (12 per box).



Reference #	Sterile	Description
7207034*		ACUFEX Single-Armed Suture Needle (1 needle), USP #1, 36" (91 cm)
7205539		ACUFEX Double-Armed Suture Needles (2 needles), USP #2, 36" (91 cm)

#### Accessories

⚙️	7207739	Knot Pusher, shoulder
⚙️	7207753	Shoulder Stitcher
⚙️	7207773	Suture Passer Crochet Hook
⚙️	7207772	Suture Pusher
⚙️	013577	45° Stitcher Cleaning Wire, non-sterile

\* Item shown

⚙️ Special, Made to Order products are available to meet the individual needs of surgeons. Please appreciate that longer lead time for delivery should be expected. For more information, please contact your sales representative or Customer Service.



# Shoulder Arthroscopy System

## ELITE<sup>®</sup> PREMIUM II Shoulder Arthroscopy System



### ELITE PREMIUM II Shoulder Arthroscopy System

The ELITE PREMIUM II Shoulder System offers the ability to house our wide array of innovative endoscopic instruments in sleek, comprehensive trays with customizable areas. The all stainless-steel trays allow for easy sterilization, while offering the durability and reliability necessary in a busy OR.

- Designed with surgeon feedback
- Vertically stacked accessibility
- Removable tray inserts
- Updated, relevant instrumentation

Reference #	Description
72202503	ELITE PREMIUM II Shoulder Arthroscopy System
<b>System includes</b>	
7209494	ELITE PREMIUM Suture Loop Vertical Grasper, blue handle
72201181	ELITE PREMIUM Combination Grasper, red handle
72201180	ELITE PREMIUM Alligator Locking Grasper, green handle
7209496	ARTHRO-PIERCE <sup>®</sup> Instrument, straight
7209497	ARTHRO-PIERCE Instrument, 45° right
7209498	ARTHRO-PIERCE Instrument, 45° left
7209499	ARTHRO-PIERCE Instrument, 35° up
7211020	ELITE PASS PREMIUM Suture Shuttle with Ratchet
72202065	ELITE PREMIUM Open Face Sliding Suture Cutter, loop handle, side loading
3801	ELITE Switching Stick
72201659	ELITE PREMIUM Hook Knife
72201660	ELITE PREMIUM Bankart Rasp
72201661	ELITE PREMIUM Knife Rasp
72201915	3.8 mm Tapered Awl
72201177	ELITE PREMIUM Crochet Hook
7209134	ELITE Calibrated Probe
72201213	ELITE PREMIUM Full Loop Knot Manipulator, silver handle (2 per box)
72201186	ARTHRO-PIERCE Instrument, curved left, inline handle
72201187	ARTHRO-PIERCE Instrument, curved right, inline handle
72202042	Shoulder Arthroscopy Sterilization Tray and Lid
7209493	ELITE Predator Tissue Grasper
7209495	ELITE Combination Tissue/Suture Grasper





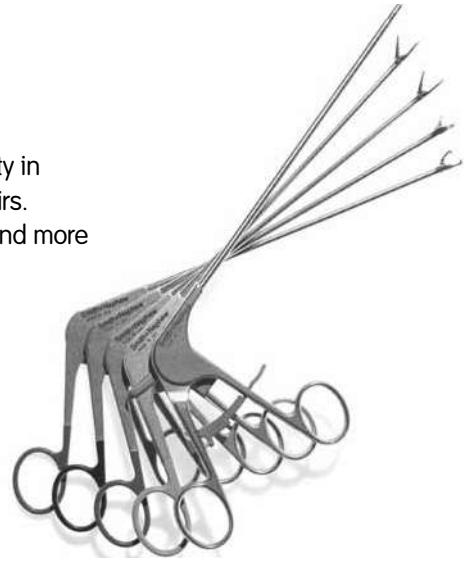

## Instrumentation

### ELITE<sup>o</sup> PREMIUM Shoulder Instruments

#### ELITE PREMIUM Shoulder Instruments

The ELITE PREMIUM Shoulder Instruments offer the surgeon comprehensive flexibility in arthroscopic and mini-open shoulder repairs, such as rotator cuff and Bankart repairs. Smith & Nephew shoulder instruments have been designed to facilitate an easier and more efficient approach to surgery.



	Reference #	Description
	72201179	ELITE PREMIUM Suture Loop Horizontal Grasper, blue handle
	72201180*	ELITE PREMIUM Alligator Locking Grasper, green handle
	72201181*	ELITE PREMIUM Combination Grasper, red handle
	7209494*	ELITE PREMIUM Suture Loop Vertical Grasper, blue handle
	72201179	ELITE PREMIUM Suture Loop Horizontal Grasper, blue handle
	72201688	ELITE PREMIUM Grasper, tapered, blue handle
	72202589	Suture Cutter
	7209492*	ELITE Sliding Suture Cutter (for use with ULTRABRAID <sup>o</sup> sutures)
	72202065*	ELITE PREMIUM Open Face Sliding suture cutter, loop handle (for use with ULTRABRAID sutures)

\* Item shown

⚙ Special, Made to Order products are available to meet the individual needs of surgeons. Please appreciate that longer lead time for delivery should be expected. For more information, please contact your sales representative or Customer Service.

## Instrumentation

### ELITE<sup>◊</sup> PREMIUM Shoulder Instruments

#### Rear Entry Femoral Aimers



Reference #	Description
7209491*	ELITE Double Hook Suture Scissors



72201659*	ELITE PREMIUM Hook Knife
-----------	--------------------------



7209145	ELITE Crochet Hook
72201177*	ELITE PREMIUM Crochet Hook



72201213*	ELITE PREMIUM Full Loop KNOT MANIPULATOR, silver handle
7210116	ELITE KNOT MANIPULATOR, QUICK-T <sup>®</sup> , black handle



72201661*	ELITE PREMIUM Knife Rasp
-----------	--------------------------



72201660	ELITE PREMIUM Bankart Rasp
013949	Shoulder Elevator
014779*	Cannulated Tissue Tensioner

⚙ 72202290	Shoulder Elevator, Blunt Up
⚙ 72202291	Shoulder Elevator, Blunt Down
⚙ 72202292	Shoulder Elevator, Up
⚙ 72202293	Shoulder Elevator, Down

## Instrumentation

### Arthroscopic Capsular Release



#### Capsular Release Punch

The geometry of these instruments, developed in conjunction with the late Dr. Doug Harryman II, will assist you in complete arthroscopic capsular release as a treatment for frozen shoulder. The extended nose of the instruments allows blunt dissection between the capsule and surrounding musculature. The pinless hinge and sharp cutting edges, synonymous with ACUFEX® instruments, offer you clean, efficient surgery.



Reference #	Description
7207539	Capsular Release Punch, straight



7207540	Capsular Release Punch, upbiter
---------	---------------------------------



7207541	Capsular Release Punch, upswept
---------	---------------------------------

### Accessories



#### TAG Arthroscopic System Components

Reference #	Description
014672	Shoulder Knot Pusher

#### T-FIX® RCG Disposables

For use with T-FIX RCG Instrument System (discontinued).

Reference #	Description
014670	T-FIX Suture Bar, 1.8 mm, with 2 preloaded T-FIX suture bars
014771	T-FIX RCG Drill Pac, sterile, with 1 drill and 2 sleeves
014762	T-FIX RCG Drill Pac, non-sterile, with 1 drill and 2 sleeves

#### Titanium T-FIX RCG

Reference #	Description
6900871	T-FIX RCG with Titanium T-Bar

## ARTHROPAK

### Customized Procedure Kit



#### ARTHROPAK Customized Procedure Kit

Smith & Nephew DYONICS® ARTHROPAK Customized Procedure Kits provide increased operational efficiencies and reduced supply expense. You customize your kit with your selection of disposable Smith & Nephew products for any arthroscopic procedure at a reduced cost.

- Free customized service
- Reduced product cost
- Save valuable time and demand on staff
- Streamlined ordering process
- Increased standardization
- Reduced inventory

DYONICS ARTHROPAK Customized Procedure Kits reduce the number of SKUs that need to be ordered and aggregate purchasing volume of arthroscopic products by enabling purchase from a single supplier. Please ask your local sales representative to demonstrate how DYONICS ARTHROPAK Customized Procedure Kits can benefit your practice.



**BIORAPTOR®**  
Knotless Suture Anchor



- Independent suture tensioning
  - Surgeon-controlled tissue shift
  - Eliminates the knot-tying step
- 

**BEAVER®**  
4.0 mm Banana Blade



- Sharp cutting edge
- Ideal for hip procedures
- Trusted by surgeons for decades

## Visualization

The Smith & Nephew Hip Arthroscopy system is compatible with standard length 30° and 70° 4.0 mm Video Arthroscopes and Direct View Arthroscopes. The sealed scope design and easy one handed light post rotation make Smith & Nephew VideoArthroscopes ideal for hip arthroscopy. Now, see more clearly than ever with the new Smith & Nephew 560 Series High Definition Camera System – offering unparalleled brightness, vivid color reproduction and greater depth of field.



VideoArthroscopes, High Definition 560H only

### VideoArthroscopes, Autoclavable

Reference #	Outer Diameter	Direction of View	Field of View	Working Length	Light Post Direction	Cannula Connection	Recommended Light Cable
72202959	4.0 mm	30°	115°	160 mm	Opposite	J-Lock	5.0 mm
72202958	4.0 mm	70°	115°	160 mm	Opposite	J-Lock	5.0 mm

### VideoArthroscopes, Non-Autoclavable

Reference #	Outer Diameter	Direction of View	Field of View	Working Length	Light Post Direction	Cannula Connection	Recommended Light Cable
72202961	4.0 mm	30°	115°	160 mm	Opposite	J-Lock	5.0 mm
72202962	4.0 mm	70°	115°	160 mm	Opposite	J-Lock	5.0 mm

Direct View Arthroscopes

### Arthroscopes, Direct View and Autoclavable

Reference #	Outer Diameter	Direction of View	Field of View	Working Length	Light Post Direction	Cannula Connection	Recommended Light Cable
72202087	4.0 mm	30°	115°	160 mm	Opposite	J-Lock	4.0 mm
72202088	4.0 mm	70°	115°	160 mm	Opposite	J-Lock	4.0 mm
72201597	4.0 mm	30°	115°	278 mm	Opposite	J-Lock	4.0 mm
72201598	4.0 mm	70°	115°	280 mm	Opposite	J-Lock	4.0 mm

Diagnostic Cannulas, Extended Length

For use with hip arthroscopy scopes REF 72201597 and 72201598

Reference #	Description
72201816	6.0 mm diagnostic cannula, double valve, rotatable
72201898	4.5 mm cannulated obturator for cannula 72201816
72200990	Storz™/Linvatec™ scope adapter
⚙️ 72203327	5.0 mm Extended Length ARTHROGARDE Hip Access Cannula, blue (Standard Hub)
⚙️ 72203326	5.5 mm Extended Length ARTHROGARDE Hip Access Cannula, red (Standard Hub)
⚙️ 72203329	5.0 mm Extended Length Obturator, Cannulated, blue, large Delrin handle, used with REF 72203327
⚙️ 72203328	5.5 mm Extended Length Obturator, Cannulated, red, large Delrin handle, used with REF 72203326



## Patient Positioning

### Supine Hip Positioning System

With the Smith & Nephew Hip Positioning System you can perform arthroscopy on most OR tables in either the lateral or supine position. This system allows a wide range of motion: it can be easily flexed, abducted or adducted – movements especially important for emerging arthroscopic techniques.

- Patient limit 6' 4" (36" inseam), 400 lbs.
- Smallest setting equivalent to 27" inseam.
- Boom transport/storage 4.5' – 5'.
- Serial numbers are located under the bellows (under peroneal post).



Reference #	Description
72201724	Supine Hip Positioning System with Leather Boot

#### System includes

72200626	Universal Hip Distractor with Leather Boot
72200627	Knee Holder
72201725	Supine Table Attachment, table width extension: 20.5"–25.5" (500–640 mm) (not radiolucent)
72200631	Perineal Post
72200632	Well Leg Holder with Leather Boot

#### Supine Accessories

Reference #	Description
72200637	Patient Transfer Board (includes board 72200638 and pad 72200639)
72200669	Storage Cart
72200633	Leather Boot (1)

#### Supine Rail Clamps

Reference #	Description
72200636	US Rail Clamps (2) – 0.375" x 1.125" (1 cm x 2.9 cm)
72200670	Eur/UK Rail Clamps (2) – 0.394" x 0.984" (1 cm x 2.6 cm) 0.250" x 1.50" (0.7 cm x 3.2 cm)
72200671	Denyer Rail Clamps (2) – 0.345" x 1.26" (0.9 cm x 3.2 cm)
72200672	Japanese Rail Clamps (2) – 0.394" x 1.181" (1 cm x 3 cm)
72200673	Swiss Rail Clamps (2)

#### Supine Single-use Disposables

Reference #	Description
72200634	Supine Perineal Post Pad (11" tall, 9" diameter, 1.5" ID) (1)
72200635	Boot Insert Pad (2)

#### Supine Replacement Parts

Reference #	Description
72202172	Hip Carriage Replacement kit – replaces the black plastic sliding mechanism on the boom
72200630	Replacement Supine Pad for Supine Table Extension
72201540	Leather Boot Replacement Straps (1 full set)
72200639	Replacement Patient Transfer Board Pad

## Patient Positioning

### Lateral Hip Positioning System



#### Lateral Hip Positioning System

Reference #	Description
72201636	Lateral Hip Positioning System with Leather Boot

#### System includes

72200626	Universal Hip Distractor with Leather Boot
72201364	Lateral Table Attachment with Perineal Post Pad, table width extension 20.5" x 25.5" (500 mm x 640 mm)

#### Lateral Accessories

Reference #	Description
72200718	Replacement Lateral Perineal Post Pad (1) – multi-use (one included with lateral table attachment 72201364)
72200669	Storage Cart
72200633	Leather Boot (1)

#### Lateral Rail Clamps

Reference #	Description
72200643	US Rail Clamps (2) 0.375" x 1.125" (1 cm x 2.9 cm)
72200675	Eur/UK Rail Clamps (2) – 0.394" x 0.984" (1 cm x 2.6 cm) 0.250" x 1.250" (1 cm x 2.6 cm)
72200676	Denyer Rail Clamps (2) – 0.250" x 1.50" (1 cm x 2.9 cm)
72200677	Swiss Rail Clamps (2)– 0.394" x 1.184" (1 cm x 3 cm)

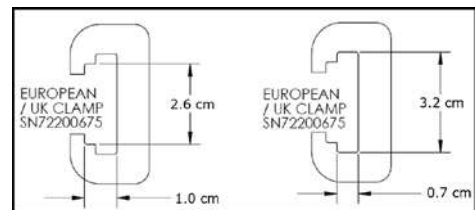

#### Replacement Parts

Reference #	Description
72201540	Leather Boot Replacement Straps (1 full set)

# Patient Positioning

## Quick Reference OR Table Compatibility Chart

Table Manufacturer	Model	Lateral Table Attachment 72201364 (500–640 mm)	Supine Table Attachment 72201725
ALM/Steris™	TRANSFERIS	No	No
Amsco™	2080	Yes	Yes
Berchtold™	B 710	Yes	Yes
	Operon D 850 & 750	Yes	Yes
	B 810	Yes	Yes
Eschmann™	T 10, T 20, & T 30	Yes	Yes
	J Series, MR Table, RX 500, & RX 600	Yes	Yes
Maquet™	1120	No	No
	Betastar 1131.12	Yes	No
	Alphastar 1132.11/12/13	Yes	Yes
	Alphstar Top (for ENT)	No	No
	Alphamaxx 1132.12	Yes	No
	Betamaquet 1140	No	No
	Alphamaquet 1150.30	Yes	Yes
	Orthostar 1420.01	Yes	No
	Magnus	Yes	Yes
Merivaara™	OP 1900	Yes	Yes
MURANAKA™	EL-905-RS	No	No
OPT™	Piano OPT/ 100 Universale 2 8612-000	Yes	Yes
Steris/ALM™	SURGIMAX	Yes	Yes
	ASC 2000	No	No
	Amsco 3085	Yes	Yes
	Surgigraphic 6000	Yes	Yes
Trumpf™	Operating Tabel top X-tra	Yes	–
	OR Table Top Pediatrics	No	–
	Extension Section Pediatrics	No	No
	Operating Tabel Top GM/GM W/GM Q	Yes	Yes
	Operating Tabel Top RY	Yes	Yes
	Operating Tabel Top GO (for ENT)	No	No
	Jupiter	Yes	Yes
	Mars	Yes	Yes
	Merkur	Yes	Yes
	Saturn	Yes	Yes
	Select	Yes	Yes
	Select L	Yes	Yes
	Saturn K	Yes	Yes
	Select LK	Yes	Yes
	Table Top Segment I30	Yes	Yes
	Pelvis Section Extension	Yes	Yes
	Titan	Yes	Yes

## Patient Positioning

### SPIDER2 and SPIDER Hip Positioning Systems



#### SPIDER2 and SPIDER Hip Positioning Systems

Increase the flexibility of your fracture table with the SPIDER2 and SPIDER Hip Positioning Systems. Stable positioning and traction while offering increased range of motion for hip arthroscopy when using a fracture table.

#### SPIDER2 Limb Positioner

Reference #	Description
72203299	SPIDER2 Limb Positioner
72203300	Switch Drape, optional (case of 20)
72203301	Battery Pack

#### SPIDER Limb Positioner

Reference #	Description
7210569	SPIDER Limb Positioner

#### Hip Positioning Components

Reference #	Description
72201427	MAXI Traction Accessory
72201425	SPIDER Boot with Foam Insole
72201426	Boot Liners (case of 4)

#### Fracture Table Adapters\*

Reference #	Description
72202060	Maquet
72202061	OSI
72202062	Trumpf

#### Semi-Disposables

Reference #	Description
72201426	Boot Liner (4)
72201429	Replacement Foam Insole (4)

\* Fracture tables must be validated for use with SPIDER and SPIDER2 Limb Positioners by the manufacturer.

## Guide Systems

### CROSSTRAC<sup>®</sup> Hip Guide System

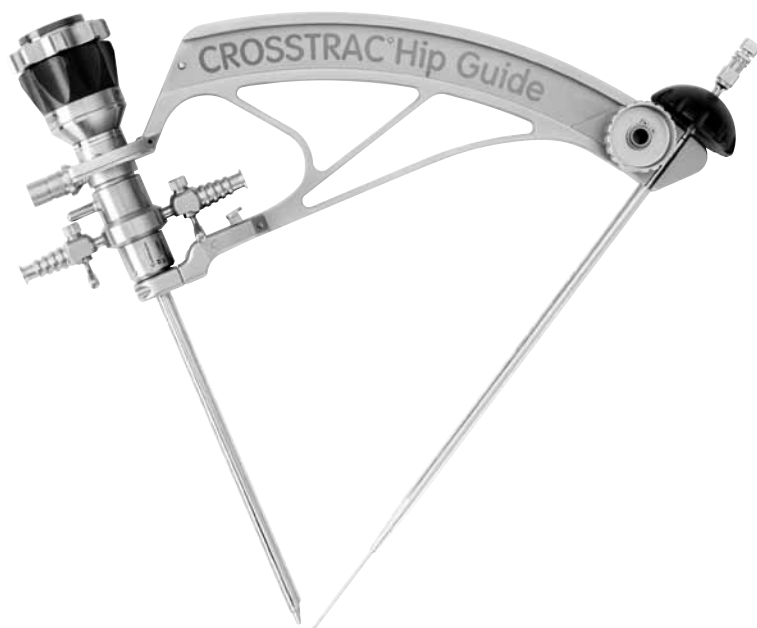

#### CROSSTRAC Hip Guide System

Accessing the hip joint has never been easier. With its unique triangulated design and needle point accuracy, the CROSSTRAC Hip Guide System allows for consistent trajectory alignment and portal placement where you want it. Use with our standard length 4 mm arthroscopes and our new atraumatic-in-design ARTHROGARDE<sup>®</sup> Hip Access Cannulas for improved tissue protection and safety.

Reference #	Description
72201832	CROSSTRAC Hip Guide System
<b>System includes</b>	
72201831	CROSSTRAC Hip Guide with Bullet (1) Includes: 72201674 CROSSTRAC Hip Guide 72201727 CROSSTRAC Hip Guide Bullet
72201741	4.5 mm ARTHROGARDE Hip Access Cannula, green (CROSSTRAC Hub) (1)
72201742	5.0 mm ARTHROGARDE Hip Access Cannula, blue (CROSSTRAC Hub) (2)
72200096	4.5 mm Cannulated Obturator with Delrin Handle, green dot (1)
72200097	5.0 mm Cannulated Obturator with Delrin Handle, blue dot (1)
72201847	CROSSTRAC Tray – included in system
<b>Sold separately</b>	
72201811	XL (extra-long) Disposable Arthroscopy Needle (17 gauge, 9" long) (5 per package)

## Hip Arthroscopy Set Cannulas and Obturators



ARTHROGARDE® Hip Access Cannulas are designed to be atraumatic, featuring smooth ends for optimal safety and high-strength design for enhanced durability.

The uniquely designed rounded ends provide a smooth surface to help protect soft tissue when performing hip arthroscopy. Plus, they're extra strong to prevent bending or wear and tear over time. Combine with our CROSSTRAC® Hip Guide System for accurate trajectories and first-time access to the hip joint.

Please note, all ARTHROGARDE Cannulas utilize J-SNAP Irrigation Extenders 72202448 or 72202449 at top of next page.

### ARTHROGARDE Hip Access Cannulas

Reference #	Description
72201741	4.5 mm ARTHROGARDE Hip Access Cannula, green (CROSSTRAC Hub)
72202003	4.5 mm ARTHROGARDE Hip Access Cannula, green (Standard Hub)
72201742	5.0 mm ARTHROGARDE Hip Access Cannula, blue (CROSSTRAC Hub)
72202004	5.0 mm ARTHROGARDE Hip Access Cannula, blue (Standard Hub)
72201743	5.5 mm ARTHROGARDE Hip Access Cannula, red
7209345	3.0 mm Cannula, Inflow
⚙ 72203133	ARTHROGARDE Slotted Cannula (4.4" working length)
72201590	ARTHROGARDE Slotted Cannula (6.2" working length)
⚙ 72203327	5.0 mm Extended Length ARTHROGARDE Hip Access Cannula, blue (Standard Hub)
⚙ 72203326	5.5 mm Extended Length ARTHROGARDE Hip Access Cannula, red (Standard Hub)

### Arthroscopic Hip Set Instrumentation – Obturators



Reference #	Description
72200884	4.5 mm Obturator, Conical, green, used with REF 72201741 and 72202003
72200885	4.5 mm Obturator, Cannulated, green, used with REF 72201741 and 72202003
72200096	4.5 mm Obturator, Cannulated, green, large Delrin handle, used with REF 72201741 and 72202003
72200882	5.0 mm Obturator, Conical, blue, used with REF 72201742 and 72202004
72200883	5.0 mm Obturator, Cannulated, blue, used with REF 72201742 and 72202004
72200097	5.0 mm Obturator, Cannulated, blue, large Delrin handle, used with REF 72201742 and 72202004
⚙ 72203329	5.0 mm Extended Length Obturator, Cannulated, blue, large Delrin handle, used with REF 72203327
72200880	5.5 mm Obturator, Conical, red, used with REF 72201743
72200881	5.5 mm Obturator, Cannulated, red, used with REF 72201743
72200098	5.5 mm Obturator, Cannulated, red, large Delrin handle, used with REF 72201743
⚙ 72203328	5.5 mm Extended Length Obturator, Cannulated, red, large Delrin handle, used with REF 72203326
7207751	5.5 mm Obturator, long, Cannulated, used with disposable cannula REF 7205360
7210392	5.5 mm Obturator, Cannulated, used with slotted cannula REF 72201590
7209349	Obturator for 3.0 mm cannula
72201355	Reuseable Obturator for 5.7 mm Flexible Cannula (use with PN 7205360, 5.7 mm cannula)

## Hip Arthroscopy Set

### Cannulas, Obturators and Irrigation Extenders



#### Arthroscopic Hip Set Instrumentation – Irrigation Extenders

Reference #	Description
72202448	J-SNAP quick release Irrigation Extenders, single valve
72202449	J-SNAP quick release Irrigation Extenders, double valve
72200026	Fluid Seal Adapter
72200027	Fluid Seals, sterile (25 per package)

## Hand Instruments and Accessories

#### Arthroscopic Hip Set Instrumentation - Probe

Reference #	Description
7207760	3.0 mm Hip Probe, long
6900221	3 mm Probe



#### Arthroscopic Hip Set Instrumentation - Switching Sticks

Reference #	Description
3801	Switching Stick 4.3 mm (13 long, not cannulated)
6905019	Cannulated Switching Stick 4.5 mm (13 long, 1.2 mm cannulation)

#### Arthroscopic Hip Set Instrumentation - Knives

Reference #	Description
72203307*	BEAVER® 4.0 mm Banana Blade, sterile, disposable (6 per box)
72203308*	BEAVER® Handle and Wrench, reusable
7210758	Banana Blade Knife, reusable
72202487	Banana Blade Knife, cannulated, reusable















\* Item shown

BEAVER® is a registered trademark of BVI.

## Hip Arthroscopy Set

### Hand Instruments and Accessories

#### Arthroscopic Hip Set Instrumentation – Basket Punches, Extended Length

	Reference #	Description
	7207545*	Rotary 2.2 mm left, loop handle
	7207544*	Rotary 2.2 mm right, loop handle
	7207735*	Scoop 1.5 mm Upbiter
	7207736*	DUCKLING° Upbiter
	7207737*	DUCKLING Upswept
	7207733*	Narrowline Upbiter
	7207734*	Narrowline Upbiter, curved right
	7210730*	STINGRAY° Basket Punch, backbiter right†
	7210731*	STINGRAY Basket Punch, backbiter left†
	7207699*	Grasper, Alligator Max
	7207700*	Grasper, Cupped, 3.4 mm
	7207731*	Grasper, PITBULL°
	7207732*	RAPTOR° Rongeur

\* Item shown

† STINGRAY Basket Punches – length extended by 2.25"



# Hip Arthroscopy Set

## Hand Instruments and Accessories

### Arthroscopic Hip Set Instrumentation – Tray

Reference #	Description
7207934	Hip Arthroscopy Tray (21" x 10" x 3.5")

### Arthroscopic Hip Set Instrumentation – Fluid Seal Adapter



Reference #	Description
72200026	Fluid Seal Adapter
72200027	Fluid Seals (use with REF 72200026) (25 per box)

### Arthroscopic Hip Set Instrumentation – Hip Pac

Reference #	Description
7209874	Disposable Hip Pac (includes 3 guidewires and 2 arthroscopy needles)



### Arthroscopic Hip Set Instrumentation – Accessories

Reference #	Description
7209351	Cap, inflow
7205395	Guidewire, nitinol 1.2 mm x 18" (45 cm) (3 per package)
7209350	Arthroscopy Needle 6", 17 gauge
7205360	Flexible Cannula 5.7 mm, disposable (6 per package)
72201355	Reusable Obturator for 5.7 mm flexible cannula (use with REF 7205360, 5.7 mm cannula)

### Hip Access System

Reference #	Description
7210583	Switching Stick, cannulated
7210582	Portal Enlarger, O.D. 5.5 mm, I.D. 4.5 mm
7210584	Modular T-Handle

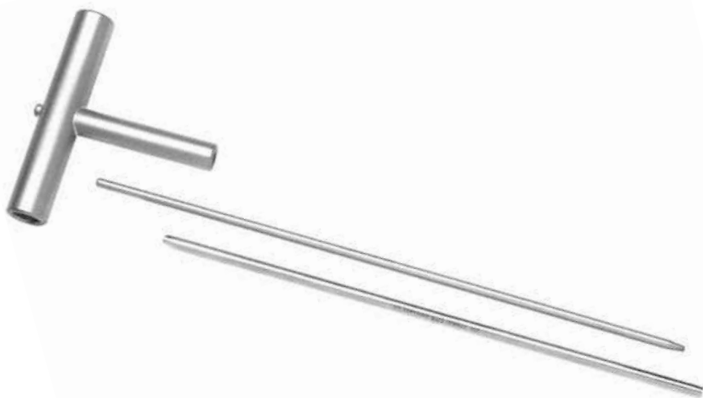

# Monopolar Hip Probes

## VULCAN® RF System Hip Probe Indications

Hip	LIGAMENT CHISEL Probe	ABLATOR® Probe	TAC-S Probe	LIGMENT CHISEL Probe	DYONICS® GLIDER Articular Cartilage Probe
Acetabular labrum resection	•	•			
Synovectomy	•	•			
Loose body excision	•				
Tendon resection and release	•	•		•	
Thermal capsulorrhaphy			•		
Tissue smoothing		•	•		•
Ligamentum teres treatment			•		
Capsular resection	•	•		•	
Chondroplasty			•		•

Source: Schenker, ML & Phillipon MJ. The Role of Flexible Radiofrequency Energy Probes in Hip Arthroscopy Techniques in Orthopaedics 2005 20 (1):37-44

Information in this chart is intended as a suggestion only. Surgeons should use their medical judgement when selecting a probe for a patient's procedure.

### DYONICS EFLEX® Monopolar Radiofrequency Probes

DYONICS EFLEX probes can deflect up to 100°, enabling access into areas of the hip joint that are difficult to reach with conventional rigid probes. Tip deflection is actuated by an easy-to-pull trigger system, with an ergonomically designed handle and palm grip. EFLEX probes are also available with an integrated power cable, eliminating the need to purchase and re-sterilize separate cables.

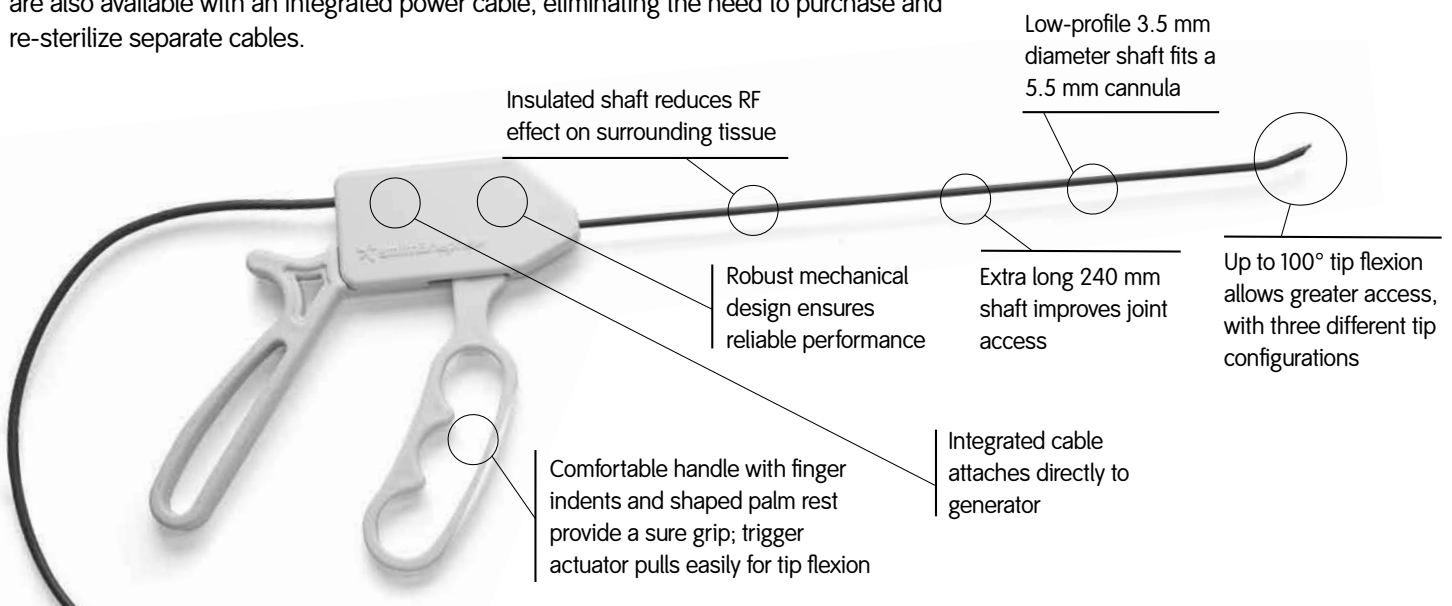

NOTE: For use with the VULCAN RF System

Call +1 800 343 5717 (U.S.) or contact your local representative.

## Monopolar Hip Probes

### VULCAN® RF System Probes



#### DYONICS® EFLEX® Monopolar Radiofrequency Probes

Reference #	Description
72200682	DYONICS EFLEX LIGAMENT CHISEL® Probe with integrated cable
72200683	DYONICS EFLEX ABLATOR® Probe with integrated cable
72200681	DYONICS EFLEX TAC-S Probe with integrated cable



#### LIGAMENT® CHISEL® Monopolar Probe

Reference #	Description
7209646	LIGAMENT CHISEL Probe, hook



#### DYONICS GLIDER® Monopolar Articular Cartilage Probe

The DYONICS GLIDER probe is an early-intervention tool for treatment of articular cartilage disease. Through controlled application of RF energy on Grade II and III chondromalacia, the GLIDER probe is designed to maximize preservation of healthy cartilage tissue while restoring a smooth gliding surface.

Reference #	Description
7210438	DYONICS GLIDER Articular Cartilage Probe

## Hip Shaver Blades and Burrs

DYONICS<sup>®</sup> High Visibility and Extended Length Blades and Burrs



### DYONICS HIGH VISIBILITY Hip Burrs

Packaged 3 per box, sterile

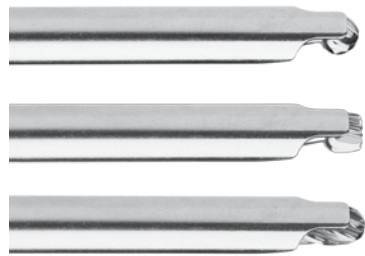

Reference #	Description	Latch Color
72203127*	5.5 mm HIGH VISIBILITY Sheath ABRADER Burr	Black
72203128	4.0 mm HIGH VISIBILITY Sheath ABRADER Burr	Purple
72203129*	5.5 mm HIGH VISIBILITY Sheath Flat Top Burr	Black
72203130	4.0 mm HIGH VISIBILITY Sheath Flat Top Burr	Purple
72203131*	5.5 mm HIGH VISIBILITY Sheath Barrel Burr	Black
72203132	4.0 mm HIGH VISIBILITY Sheath Barrel Burr	Purple

### DYONICS POWER Shaver Burrs, 18 cm working length, partial hood.

Packaged 3 per box, sterile



Reference #	Description
72200080*	4.0 mm Long ABRADER
72200082*	5.5 mm Long ABRADER

### DYONICS POWER Shaver Blades, 18 cm working length

Packaged 3 per box, sterile



Reference #	Description
72200414*	4.5 mm Long INCISOR <sup>®</sup> Plus ELITE
72200494*	4.5 mm Long Curved INCISOR Plus ELITE
7205335*	4.5 mm Long Curved Full Radius Concave
7205336	4.5 mm Long Curved Full Radius Convex
7205341*	4.5 mm Long Full Radius
7205343*	4.5 mm Long INCISOR
7210979*	4.5 mm Long BONECUTTER <sup>®</sup>
6900678*	5.5 mm Long Full Radius

\* Item shown

## Repair Products

### Suture, Suture Anchors and Instruments



Smith & Nephew offers you a complete repair system, including a variety of suture anchors designed specifically for labral repair in the hip, CLEAR-TRAC<sup>®</sup> COMPLETE disposable hip cannulas, as well as suture passing, microfracture and other repair instruments.

#### BIORAPTOR<sup>®</sup> Knotless Suture Anchors and Instruments

Reference #	Description
72202397	BIORAPTOR Knotless Suture Anchor
72201388	2.9 mm Inline Drill Guide, spike tip
72201390	2.9 mm Inline Drill Guide, crown tip
72201393	2.9 mm Inline Obturator, cannulated
72201392	2.9 mm Inline Obturator, blunt
72202404	Twist Drill for 2.9 Suture Anchor

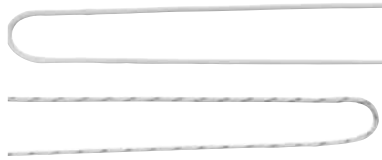

#### ULTRABRAID<sup>®</sup> High Strength Sutures

Reference #	Description
72200886	ULTRABRAID #2 white suture 38", 10 per package, sterile
72200887	ULTRABRAID #2 COBRAID suture 38", 10 per package, sterile



#### ACCU-PASS<sup>®</sup> Disposable Suture Shuttles, #1 Monofilament 48" Included

Reference #	Description
7210423	ACCU-PASS 45°, left, sterile
7210424	ACCU-PASS 45°, right, sterile
7210425	ACCU-PASS 45°, upbend, sterile
7210426	ACCU-PASS straight, sterile
72200419	ACCU-PASS 70°, upbend, sterile
72201361	ACCU-PASS monofilament, size #1, single pack, 10 per package, sterile

## Repair Products

### Suture, Suture Anchors and Instruments



Knotted 2.3 mm Suture Anchors and Instruments  
Absorbable

Reference #	Description
72201991	OSTEORAPTOR® 2.3 PLLA-HA Suture Anchor with 1 #2 ULTRABRAID Suture (white)
72201992	OSTEORAPTOR 2.3 PLLA-HA Suture Anchor with 1 #2 ULTRABRAID Suture (COBRAID-black)
72201993	OSTEORAPTOR 2.3 PLLA-HA Suture Anchor with 1 #2 ULTRABRAID Suture (COBRAID-blue)

PEEK-OPTIMA® polymer from Invibio®



Reference #	Description
72201541	BIORAPTOR 2.3 PK Suture Anchor with 1 #2 ULTRABRAID Suture (COBRAID-blue)
72201542	BIORAPTOR 2.3 PK Suture Anchor with 1 #2 ULTRABRAID Suture (COBRAID-black)
72201543	BIORAPTOR 2.3 PK Suture Anchor with 1 #2 ULTRABRAID Suture (white)

Inline Drill Guides



Reference #	Description
72201105*	2.3 mm Inline Drill Guide, fishmouth tip



72201110*	2.3 mm Inline Drill Guide, spike tip
-----------	--------------------------------------



72201111*	2.3 mm Inline Drill Guide, crown tip
-----------	--------------------------------------



72201107*	2.3 mm Inline Obturator, cannulated
-----------	-------------------------------------



72201112	2.3 mm Inline Obturator, trocar tip
72201106*	2.3 mm Inline Obturator, non-cannulated
72201824	2.6 mm Twist Drill for 2.3 mm Suture Anchor

\* Item shown

## Repair Products

### Drill Guides, Suture Anchors and Instruments



#### Knotted 2.9 mm Suture Anchors and Instruments

Reference #	Description
72202165	OSTEORAPTOR® 2.9 Hip Suture Anchor with 1 #2 ULTRABRAID® Suture (white)
72201994	OSTEORAPTOR 2.9 Hip Suture Anchor with 1 #2 ULTRABRAID Suture (COBRAID-blue)
72202404	Twist Drill for 2.9 Suture Anchor
72201395	Spade Drill Bit for 2.9 Suture Anchor
72201388	2.9 mm Inline Drill Guide, spike tip
72201389	2.9 mm Inline Drill Guide, fishmouth tip
72201390	2.9 mm Inline Drill Guide, crown tip
72201391	2.9 mm Inline Drill Guide, offset fishmouth tip
72201392	2.9 mm Inline Obturator, blunt tip
72201393	2.9 mm Inline Obturator, cannulated
72201394	2.9 mm Inline Obturator, trocar tip

## Repair Products

### HIPSTRUMENTS Hip Arthroscopy Repair System

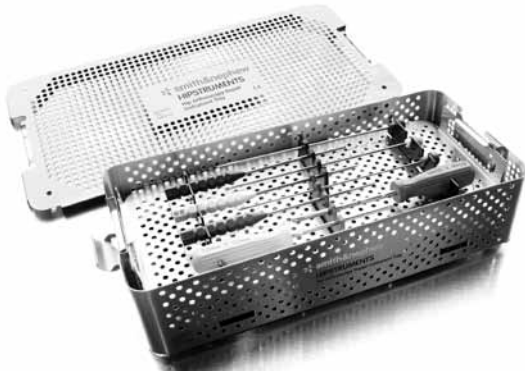

HIPSTRUMENTS Hip Arthroscopy Repair System

Reference #	Description
72203228	HIPSTRUMENTS Hip Repair System
<b>System includes</b>	
 72202119*	Microfracture Pick XL, 30°
 72202120*	Microfracture Pick XL, 45°
 72202210*	Microfracture Pick XL, 60°
 72202583*	Open Curette XL, 4.75 mm
 72202584*	Open Curette XL, reverse cut 6.0 mm
 72203052*	Suture Cutter Flush XL (leaves no tail)
 72202588*	Suture Curette XL (leaves tail, has ACUFEX Pro Handle)
 7210758*	Banana Blade, reusable
 72202628*	Elevator XL
 72202629*	Rasp XL
 72202587*	Knot Pusher XL
 72202683*	ARTHRO-PIERCE° XL, straight
 72202586*	ARTHRO-ROUND XL
7209145	Crochet Hook
72202732*	HIPSTRUMENTS Sterilization Tray

\* Item shown



## Cannula Systems

### CLEAR-TRAC<sup>®</sup> COMPLETE Disposable Hip Cannula System



Cannula features all new, triple-seal system and integrated suture management.

Reference	Description
72200439	CLEAR-TRAC COMPLETE Hip Cannula 7.0 mm x 110 mm (6 per box)
72200436	CLEAR-TRAC COMPLETE Hip Cannula 8.5 mm x 110 mm (6 per box)
72200440	CLEAR-TRAC COMPLETE Hip Cannula 7.0 mm x 90 mm (6 per box)
72200437	CLEAR-TRAC COMPLETE Hip Cannula 8.5 mm x 90 mm (6 per box)
72200445	Reusable Obturator, 7.0 mm x 110 mm
72200442	Reusable Obturator, 8.5 mm x 110 mm
72200446	Reusable Obturator, 7.0 mm x 90 mm
72200619	Reusable Obturator, 8.5 mm x 90 mm
72201355	Reuseable Obturator for 5.7 mm Flexible Cannula (use with REF 7205360, 5.7 mm cannula), black handle
72200902	CLEAR-TRAC COMPLETE Threaded Cannula with disposable obturator, green, 8.5 mm x 90 mm (10 per box)
72200424	CLEAR-TRAC FLEXIBLE Threaded Cannula with disposable obturator, lime green, 8.0 mm x 90 mm (10 per box)
72200910	Reusable Obturator (4.3 mm connection), green, 8.5 mm x 90 mm for use with 72200902 cannula
72200913	Reusable Obturator (solid), green, 8.5 mm x 90 mm for use with 72200902 cannula
72200899	Reusable Obturator (4.3 mm connection), lime green, 8.0 mm x 90 mm for use with 72200424 cannula

#### Disposable Repair Kit

Reference	Description
72200803	Philippon Labral Repair Kit

#### Kit Includes

72202165	(2) OSTEORAPTOR <sup>®</sup> 2.9 Hip Suture Anchors with (1) ULTRABRAID <sup>®</sup> #2 Suture
72200436	(1) CLEAR-TRAC COMPLETE Hip Cannula 8.5 mm x 110 mm (6 per box)
72200082	(1) Extra length ABRADER Burr

## ARTHROPAK

### Customized Procedure Kit



#### ARTHROPAK Customized Procedure Kit

Smith & Nephew DYONICS® ARTHROPAK Customized Procedure Kits provide increased operational efficiencies and reduced supply expense. You customize your kit with your selection of disposable Smith & Nephew products for any arthroscopic procedure at a reduced cost.

- Free customized service
- Reduced product cost
- Save valuable time and demand on staff
- Streamlined ordering process
- Increased standardization
- Reduced inventory

DYONICS ARTHROPAK Customized Procedure Kits reduce the number of SKUs that need to be ordered and aggregate purchasing volume of arthroscopic products by enabling purchase from a single supplier. Please ask your local sales representative to demonstrate how DYONICS ARTHROPAK Customized Procedure Kits can benefit your practice.



Wrist Tower



- Designed specifically for wrist arthroscopy
- Exceptional access and precise maneuverability

Extremity Suture Anchors



- Designed for demanding hand/wrist and foot/ankle procedures
- Innovative handle design provides easy suture deployment
- Inserters come pre-loaded with ULTRABRAID® sutures, needles and anchors

## Suture Anchors and Anchor Accessories

The Smith & Nephew anchor systems are designed for demanding hand/wrist and foot/ankle procedures. The innovative handle design simplifies surgical procedures.

Each inserter comes pre-loaded with ULTRABRAID® sutures, needles and anchor.  
A simple tap or twist of the handle provides easy suture deployment.

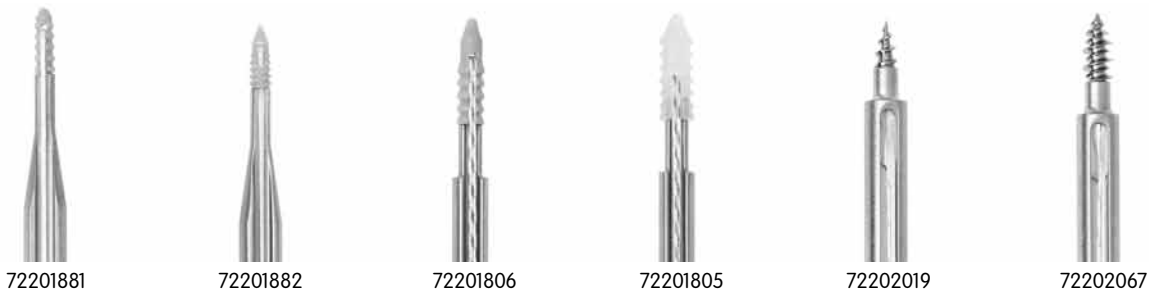

### PEEK Anchors

Reference #	Description
72201881*	DYNOMITE® 2.0 mm PEEK with 1 ULTRABRAID Suture Size 2-0 and Needles
72201882*	SPYROMITE 2.0 mm PEEK with 1 ULTRABRAID Suture Size 2-0 and Needles
72201806*	RAPTORMITE® 3.0 mm PEEK with 2 ULTRABRAID Sutures Size 0 and Needles

### Absorbable Anchors

Reference #	Description
72201805*	RAPTORMITE 3.7 mm PLLA with 2 ULTRABRAID Sutures Size 0 and Needles

### Titanium Anchors

Reference #	Description
72202019*	MINITAC® 2.0 mm Ti with 2 ULTRABRAID Sutures Size 2-0 and Needles
72200795	MINITAC 2.0 mm Ti with 2 DURABRAID® Sutures Size 3-0 (Anchor package also includes: Disposable Drill Guide and Disposable Drill)
7210303	MINITAC 2.0 mm Ti with 2 DURABRAID Sutures Size 3-0 and Needles (Anchor package also includes: Disposable Drill Guide and Disposable Drill)
72202067*	TWINFIX® 2.8 mm Ti with 2 ULTRABRAID Sutures Size 2-0 and Needles
72200796	TWINFIX 2.8 mm Ti with 2 DURABRAID Sutures Size 2-0
7210301	TWINFIX 2.8 mm Ti with 2 DURABRAID Sutures Size 2-0 and Needles

### Anchor Accessories

Reference #	Description
72202040	1.8 mm Drill and Guide for SPYROMITE 2.0 mm and MINITAC 2.0 mm Suture Anchor
72202082	1.6 mm Drill and Guide for DYNOMITE 2.0 mm Suture Anchor
72202038	3.2 mm Drill and Guide for RAPTORMITE 3.7 mm Suture Anchor
72202039	2.6 mm Drill and Guide for RAPTORMITE 3.0 mm Suture Anchor
7209506	1.8 mm Drill for TWINFIX 2.8 mm Suture Anchor
7209118	Drill Guide for TWINFIX 2.8 mm Suture Anchor

## Patient Positioning FERKEL™ Thigh System



Reference #	Description
72201812*	FERKEL Thigh Holder (System includes 1 disposable pad)
013227	Table Clamp

Disposable component

Reference #	Description
72201813	Foam Pad (1 per box)
72201814	Foam Pad (5 per box)



### Guhl Non-invasive Ankle Distractor System

This optimal design addresses low-cost, simple, non-invasive ankle distraction.

Reference #	Description
7207079	Guhl Non-Invasive Ankle Distractor System

#### System includes

7207023*	Guhl Non-Invasive Ankle Distractor
014459*	Support Bar
013227*	Table Clamp
7207032	Guhl Non-Invasive Ankle Distractor Sterilization Tray



#### Individual Components and Replacement Parts

Reference #	Description
7207023	Guhl Non-Invasive Ankle Distractor
346103	Replacement Loop Adaptor
40005103	Replacement Hex Acorn Nut
014466	Replacement pins for Ankle Distractor (6 per box)
014459	Support Bar 15 and 1/2" long
013227	Table Clamp
7207032	Guhl Non-Invasive Ankle Distractor Sterilization Tray
3134143	Clamp for larger beds

Disposable component

Reference #	Description
014407*	Ankle Distractor Foot Straps, sterile, latex free (6 per box)



## Patient Positioning

### Limb Positioners



#### Wrist Tower Kit and Accessories

Reference #	Description
72202056	Wrist Tower System

#### System includes

72202114	Wrist Tower
7210577	Traction Accessory
72200660	Wrist Arthroscopy Accessory with Wrist Plate

#### Finger Traps (Disposable)

72201550	Small/Medium Wrist Stabilization Kits (5 per case)
72201551	Medium/Large Wrist Stabilization Kits (5 per case)
72201552	Large/XLarge Wrist Stabilization Kits (5 per case)

#### Additional Accessories

72200643	US Bed Rail (2)
72200675	Euro Bed Rail (2)
72200666	Wrist Plate replacement (radiolucent – shows a shadow)
72200665	Finder Trap Sizing Ring
72202309	Wrist Tower Tray
72202310	Wrist Accessory Tray



#### SPIDER2 and SPIDER Limb Positioners – Wrist

Reference #	Description
72203299	SPIDER2 Limb Positioner
7210569	SPIDER Limb Positioner
7210570	Piggy Back Connector, 2 per box, (required for 7210569)
72200660	Wrist Arthroscopy Accessory With Wrist Plate
72200664	Wrist Counter Traction Post
7210577	Traction Accessory

#### Finger Traps (Disposable)

72201550	Small/Medium Wrist Stabilization Kits (5 per case)
72201551	Medium/Large Wrist Stabilization Kits (5 per case)
72201552	Large/XLarge Wrist Stabilization Kits (5 per case)

## Patient Positioning

### Limb Positioners



#### SPIDER2 and SPIDER Limb Positioners – Ankle

Reference #	Description
72203299	SPIDER2 Limb Positioner
7210569	SPIDER Limb Positioner
7210570	Piggy Back Connector, 2 per box, (required for 7210569)
7210577	Traction Accessory
72202932	Ankle Arthroscopy Accessory (2 units)
72200918	SPIDER Cart

#### Disposable

72202931	Ankle Stabilization Kits (6 units)
----------	------------------------------------



#### SPIDER2 and SPIDER Limb Positioners – Elbow (supine)

Reference #	Description
72203299	SPIDER2 Limb Positioner
7210569	SPIDER Limb Positioner
7210570	Piggy Back Connector (2 per box, required for 7210569)
7210572	Elbow Connection Bar (2 per box)
7210749	90° Connector
72200918	SPIDER Cart

#### Disposable

7210574	Elbow Stabilization Kit (12 per box)
---------	--------------------------------------



#### Western Elbow Positioner (lateral or prone)

Reference #	Description
7210575	Western Elbow Positioner

#### Finger Traps (Disposable)

Reference #	Description
72201550	Small/Medium Wrist Stabilization Kits (5 per case)
72201551	Medium/Large Wrist Stabilization Kits (5 per case)
72201552	Large/XLarge Wrist Stabilization Kits (5 per case)



#### SPIDER2 Limb Positioner – Knee

Reference #	Description
72203299	SPIDER2 Limb Positioner
7210570	Piggy Back (2 units)
72203239	3D SPIDER Connector (one required for each Leg Accessory 72203236 and 72203235)
72203235	SPIDER Leg Accessory, Left
72203236	SPIDER Leg Accessory, Right
72200918	SPIDER Cart

#### Disposable

72203238	Leg Stabilization Kit (10 per case)
----------	-------------------------------------



# Instrumentation

## Foot and Ankle Instruments

### ACUFEX<sup>®</sup> Extremity Arthroplasty System

Low profile, hand-held instruments designed for better access, grasping and maneuverability for foot, ankle and elbow procedures.

Reference #	Description
-------------	-------------

7207036	Small Joint Arthroplasty System
---------	---------------------------------

**System includes**

014843*	RAPTOR <sup>®</sup> Jr. Punch
---------	-------------------------------

014844*	Blunt Nose Jr. Punch
---------	----------------------

014844*	Blunt Nose Jr. Punch
---------	----------------------

014847*	Closed Curette
---------	----------------

014896*	Osteotome
---------	-----------

014848	Probe
--------	-------

7207019*	Small Joint Arthroplasty System Sterilization Tray
----------	--

Reference #	Description
-------------	-------------

013219*	Small Joint Grasper
---------	---------------------

72203612	Small Joint Grasper with Ratchet
----------	----------------------------------

3499*	DYOVAC <sup>®</sup> Straight Suction Punch, 2.5 mm
-------	--

### Small Joint Curette System

Reference #	Description
-------------	-------------

014846*	Open Curette
---------	--------------

72201795	Small Joint Curette System (also includes 011703 sterilization tray)
----------	--

**System includes**

72201376	FERKEL <sup>™</sup> 15° Open Curette, 4 mm
----------	--

72201377	FERKEL 30° Open Curette, 2.5 mm
----------	---------------------------------

72201378	FERKEL 15° Open Curette, 2.5 mm
----------	---------------------------------

72201379*	FERKEL 15° Anterior Lesion Curette, 2.5 mm "FERKEL Hoe"
-----------	---

011703	Sterilization tray
--------	--------------------

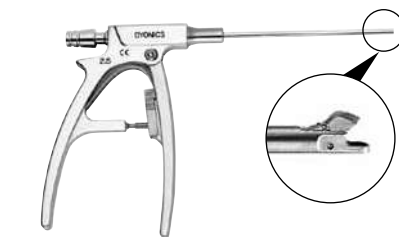

\* Item shown

## Instrumentation

### Wrist and Ankle Instruments



#### MICRO VECTOR® Drill Guide System

A straightforward, versatile approach to arthroscopically assisted pin placement in either the ankle or wrist.

Reference #	Description
4314	MICRO VECTOR Drill Guide System

#### System includes



4291	MICRO VECTOR Drill Guide
4297	Offset Drill Guide
4295	K-Wire Guide, .045" (1.1 mm)
4296	K-Wire Guide, .062" (1.6 mm)
7204612	K-Wire Guide, .125" (3.2 mm)
1030088	MICRO VECTOR Surgical Technique Manual

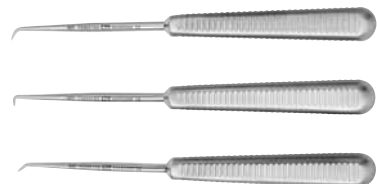

#### Small Joint Microfracture Picks

Reference #	Description
72202153	Microfracture Pick 90°, Small
72202154	Microfracture Pick 65°, Small
72202155	Microfracture Pick 40°, Small

# Instrumentation

## Ankle and Wrist Instruments

### ACUFEX<sup>®</sup> Loop Handle

Micro instruments designed to provide maximum grasping, resecting capability and excellent maneuverability for easy access to tight, small joints (wrist, elbow and ankle).

All feature pinless hinge design for unparalleled strength and reliability.

Reference #	Description
-------------	-------------

7207868	Micro Instrument System
---------	-------------------------

**System includes**

- 7207598\* MicroGrasper, straight
- ⚙ 72203613 MicroGrasper with Ratchet, straight (not included in system)
- ⚙ 7210753 MicroGrasper, Downswept 10° (not included in system)

- 7207599\* MicroGrasper, Up 10°

- 7207600\* MicroPunch, straight
- ⚙ 7210754 MicroPunch, Downswept 10° (not included in system)

- 7207601\* Teardrop Punch, right
- ⚙ 7210755 Teardrop Punch, Downswept 10°, right (not included in system)

- 7207602\* Teardrop Punch, left
- ⚙ 7210756 Teardrop Punch, Downswept 10°, left (not included in system)

- 3312\* Probe

- 3499\* DYOVAC<sup>®</sup> Straight Suction Punch, 2.5 mm

- 7207935\* Sterilization Tray; holds up to eight Micro Instruments, plus probe

- ⚙ 3134236 Small Joint Probe (Not included in system)

- ⚙ 3134237 Small Joint Elevator (Not included in system)

### Small Joint Microfracture Picks

Reference #	Description
-------------	-------------

72202153*	Microfracture Pick 90°, Small
-----------	-------------------------------

72202154*	Microfracture Pick 65°, Small
-----------	-------------------------------

72202155*	Microfracture Pick 40°, Small
-----------	-------------------------------

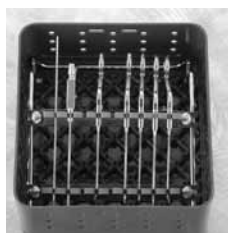
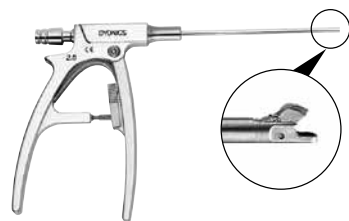

\* Item shown

## Cannula Sets



### 2.2 mm Operative Cannula Set

Reference #	Description
4294	2.2 mm Operative Cannula Set for 1.9 mm SHORT SCOPE with light post on OPPOSITE SIDE of direction of view

#### Set includes

3865	2.2 mm Short Cannula, with flow port
3866	2.2 mm Short Trocar, sharp tip
3867	2.2 mm Short Obturator, conical tip
3312	TMJ/Wrist Probe



### 2.9 mm Operative Cannula Set

Reference #	Description
3713	2.9 mm Operative Cannula Set for 2.7 mm LONG SCOPE with light post on OPPOSITE SIDE of direction of view

#### Set includes

3672	2.9 mm Short Cannula with finger post (2 per set)
3785	2.9 mm Short Trocar, sharp tip
3807	2.9 mm Short Obturator, conical tip
72203362	2.9 mm Blunt Obturator
3671	Irrigation Extender, single-valve, fixed
3696	Infusion Adaptor



### 2.9 mm Operative Cannula Set

Reference #	Description
3800	2.9 mm Operative Cannula Set for 2.7 mm SHORT SCOPE with light post on OPPOSITE SIDE of direction of view

#### Set includes

3781	2.9 mm Short Cannula with flow port (2 per set)
3807	2.9 mm Short Obturator, conical tip
3786	2.9 mm Short Obturator, blunt tip
3312	TMJ/Wrist Probe

### Other Cannulas

Reference #	Description
⚙ 72201751	2.9 mm Cannula, double valve, rotatable
⚙ 72201752	2.9 mm Obturator (use with 72201751)
⚙ 72201792	3.8 mm Cannula, double valve, rotatable
⚙ 72201849	2.2 mm Short Cannula, double valve, rotatable

## Cannula Sets



### 3.6 mm Operative Cannula Set

Reference #	Description
4317	3.6 mm Operative Cannula Set for 2.7 mm SHORT SCOPE with light post on OPPOSITE SIDE of direction of view



#### Set includes

4308	3.6 mm Operative Cannula, single-valve, fixed
4309	3.6 mm Sharp Trocar
4310	3.6 mm Obturator, conical tip

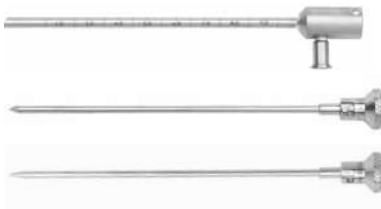

### 2.9 mm Diagnostic Cannula Set

Reference #	Description
3714	2.9 mm Diagnostic Cannula Set for 2.7 mm LONG SCOPE with light post on OPPOSITE SIDE of direction of view

#### Set includes

4419	2.9 mm Cannula with flow port
3691	2.9 mm Trocar, sharp tip
3692	2.9 mm Obturator, conical tip

### Operative Cannulas and Inflow Cannulas



Reference #	Description
3672	2.9 mm Short cannula with finger post
6900853*	2.9 mm Short cannula, low flow, double valve (Use with 2.7 mm short arthroscope)
6900392	2.9 mm Standard cannula, low flow, double valve, rotatable (Use with 2.7 mm standard length arthroscope)
72201751	2.9 mm Short cannula, double-valve, rotatable
72201752	Obturator
3807	Conical Obturator (Use with 3672 and 6900853)
7210715	3.8 mm Short cannula, double valve (Use with 2.7 mm short arthroscope), rotatable
7207789	3.8 mm Short cannula, single valve
4527	3.8 mm Obturator, conical tip (Use with 7210715 or 7207789)
7205999	4.6 mm Standard cannula, high flow, double valve (Use with 2.7 mm standard arthroscope)
⚙️ 72200121	4.6 mm Standard cannula, high flow, single valve (Use with 2.7 mm standard arthroscope)
4439	4.6 mm Obturator, conical tip (Use with 7205999 or 72200121)

## Cannula Sets

Use with 2.7 mm Arthroscopes, standard length

Reference #	Description
72200121	4.6 mm Rotatable Cannula, single-valve, standard length
7205999	4.6 mm Rotatable Cannula, double-valve, standard length
4439	Obturator, Conical Tip for 4.6 mm Rotatable Cannulas, standard length
72203536	3.8 mm Rotatable Cannula, single-valve, standard length
72201792	3.8 mm Rotatable Cannula, double-valve, standard length
7205993	Obturator, Conical Tip for 3.8 mm Rotatable Cannulas, standard length
72203624	2.9 mm Rotatable Cannula, double-valve, standard length
72203625	Obturator, Conical Tip for 4.6 mm Rotatable Cannulas, standard length

Use with 2.7 mm Arthroscopes, short length

Reference #	Description
7207789	3.8 mm Rotatable Cannula, single-valve, short length
7210715	3.8 mm Rotatable Cannula, double-valve, short length
4527	Obturator, Conical Tip for 3.8 mm Rotatable Cannulas, short length
6900513	Obturator, Blunt Tip for 3.8 mm Rotatable Cannulas, short length
72203138	Trocar, Sharp Tip for 3.8 mm Rotatable Cannulas, short length
72201751	2.9 mm Rotatable Cannula, double-valve, short length
72201752	Obturator, Conical Tip for 2.9 mm Rotatable Cannulas, short length

Use with 1.9 mm Arthroscopes, short length

Reference #	Description
72201849	2.2 mm Rotatable Cannula, double-valve, short length
72203625	Obturator, Conical Tip for 2.2 mm Rotatable Cannulas, short length

# Shaver System, Blades and Burrs

## DYONICS<sup>®</sup> POWERMINI<sup>®</sup> Shaver System



DYONICS POWERMINI shaver blades and burrs are designed exclusively for the POWERMINI Shaver Handpiece (REF 72201500 and REF 72201503 pg. G-2). All blades are 7 cm in length and packaged sterile, 6 units per box.

### DYONICS POWERMINI Shaver Blades



Reference #	Description	Latch Color
72201504*	2.0 mm TURBOWHISKER	Yellow
72201505	2.9 mm TURBOWHISKER	Green
72201506*	2.9 mm Cutter	Beige
72201507*	2.0 mm Full Radius	Blue
72201509	2.9 mm Full Radius	Red
72201510	3.5 mm Full Radius	Plum
72201517	3.5 mm Full Radius, BONECUTTER <sup>®</sup>	Plum
72201512*	3.5 mm RAZORCUT <sup>®</sup>	Pumpkin/orange
72201513	2.9 mm INCISOR <sup>®</sup> Plus ELITE	Peach
72201514*	3.5 mm INCISOR Plus ELITE	Sage green
72201515*	3.5 mm Curved INCISOR Plus ELITE	Sage green

### DYONICS POWERMINI Burrs



Reference #	Description	Latch Color
72201518*	2.9 mm ABRADER	Orange
72201519	3.5 mm ABRADER	Aqua
72201520*	2.9 mm Barrel Burr	Purple

\* Item shown

## Shaver System, Blades and Burrs

### DYONICS<sup>®</sup> Motor Drive Units and Shaver Systems



#### DYONICS Mini-Motor Drive

Reference #	Description
7205357	DYONICS Mini-Motor Drive, suction lever, 10 ft (3 m) cord

#### Disposable Mini Blades/Burrs

Used with the Smith & Nephew DYONICS Power/EP-1 Mini Motor Drive (REF 7205357 above). Indications: Small joint arthroscopy. Packaged 6 per box, sterile



Power/EP-1 Reference #	Description	Hub Color
3606*	2.9 mm Cutter, 7 cm length	Beige
3407*	2.0 mm TURBOWHISKER, 7 cm length	Yellow
3418	2.9 mm TURBOWHISKER, 7 cm length	Green
3410*	2.0 mm Full Radius, 7 cm length	Blue
3419	2.9 mm Full Radius, 7 cm length	Red
6900927	Blade, BONECUTTER <sup>®</sup> , FR, 3.5, DSPL	
3553*	2.9 mm Barrel Abrader, 7 cm length	Purple
3530*	2.9 mm Abrader, 7 cm length	Orange
3819	3.5 mm Abrader, 7 cm length	Aqua
4224*	3.5 mm RAZORCUT <sup>®</sup> , 7 cm length	Pink
4225*	3.5 mm INCISOR <sup>®</sup> , 7 cm length	Turquoise
7209065	2.9 mm INCISOR, 7 cm length	Lime green
7209085	2.0 mm INCISOR, 7 cm length	Navy blue



#### Disposable Mini Blades – Long and Curved

Indications: Small joint arthroscopy. Packaged 6 per box, sterile

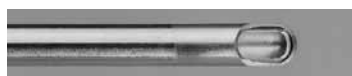

Power/EP-1 Reference #	Description	Hub Color
7205474*	3.5 mm Full Radius, 8 cm length	Plum
7210488	3.5 mm Full Radius curved, concave	Forest green
7205477*	3.5 mm RAZORCUT, 8 cm length	Pumpkin/orange
7205558*	3.5 mm curved, concave, INCISOR, 8 cm length	Brick red
7205476*	3.5 mm INCISOR Plus, 8 cm length	Sage green

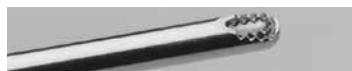



## Visualization

### Small Joint Arthroscopes

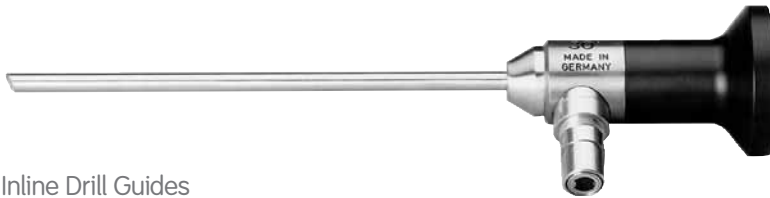

#### Inline Drill Guides

#### Videarthroscope, Autoclavable 470 heads only

Reference #	Focal Length	Outer Diameter	Direction of View	Field of View	Working Length	Light Post Direction	Cannula Connection	Recommended Light Cable
7209402	35 mm	2.7 mm	30°	90°	120 mm	Opposite	J-Lock	4.0 mm
7205929	35 mm	2.7 mm	30°	90°	67 mm	Opposite	J-Lock	4.0 mm

#### VideoArthroscopes, Non-autoclavable

Reference #	Focal Length	Outer Diameter	Direction of View	Field of View	Working Length	Light Post Direction	Cannula Connection	Recommended Light Cable
3632	35 mm	2.7 mm	30°	90°	120 mm	Opposite	J-Lock	4.0 mm
3768	35 mm	2.7 mm	30°	90°	67 mm	Opposite	J-Lock	4.0 mm
3863	35 mm	1.9 mm	30°	75°	65 mm	Opposite	J-Lock	2.0 mm
⚙️ 4130†	25 mm	2.7 mm	30°	90°	120 mm	Opposite	J-Lock	4.0 mm
4131†	25 mm	2.7 mm	30°	90°	67 mm	Opposite	J-Lock	4.0 mm
4132†	25 mm	2.7 mm	70°	90°	70 mm	Opposite	J-Lock	4.0 mm
7208133†	25 mm	1.9 mm	30°	75°	62 mm	Opposite	J-Lock	2.0 mm

#### Direct-View, Autoclavable

Reference #	Outer Diameter	Direction of View	Field of View	Working Length	Light Post Direction	Cannula Connection	Recommended Light Cable
7205682	2.7 mm	30°	90°	67 mm	Opposite	J-Lock	4.0 mm
7205681	2.7 mm	30°	80°	120 mm	Opposite	J-Lock	4.0 mm

#### Direct-View, Non-autoclavable

Reference #	Outer Diameter	Direction of View	Field of View	Working Length	Light Post Direction	Cannula Connection	Recommended Light Cable
3625	2.7 mm	30°	90°	120 mm	Opposite	J-Lock	4.0 mm
3947	2.7 mm	30°	90°	67 mm	Opposite	J-Lock	4.0 mm

#### Carpal Tunnel VideoEndoscope

Reference #	Description
⚙️ 4139Z	Carpal Tunnel VideoEndoscope, 4 mm x 30°, 25 mm focal length



\* Item shown  
† HD Compatible

# Chondral Resurfacing Systems

## MOSAICPLASTY<sup>®</sup>

MOSAICPLASTY is an autogenous osteochondral transplantation system that allows for arthroscopic or open treatment of cartilaginous defects of the knee and ankle.

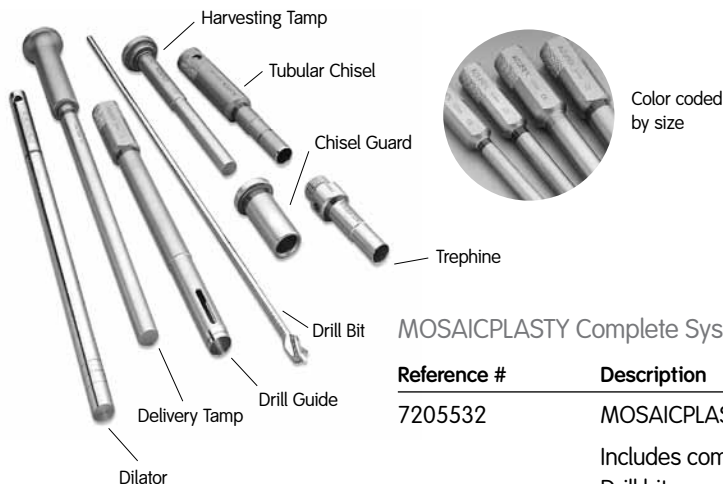

### MOSAICPLASTY Complete System

Reference #	Description
7205532	MOSAICPLASTY Complete System Includes components listed on pg. A-63 Drill bits required but not included MOSAICPLASTY Complete Sterilization Tray included (REF 7205507) Trepines for hard bone coring optional but not included

### MOSAICPLASTY Precision System

Reference #	Description
7205605*	MOSAICPLASTY Precision System Includes only 2.7 mm, 3.5 mm and 4.5 mm components Drill bits required but not included MOSAICPLASTY Precision Sterilization Tray included (REF 72202428) Trepines for hard bone coring optional but not included

### MOSAICPLASTY DP Disposable System

Requires the use of the Graft Placement Drill Guides, Dilators, and Delivery Tamps.

Reference #	Description
7209234	Disposable Harvesting Set, 3.5, includes disposable chisel, tamp, and drill bit, blue
7209235	Disposable Harvesting Set, 4.5, includes disposable chisel, tamp, and drill bit, green
7209236	Disposable Harvesting Set, 6.5, includes disposable chisel, tamp, and drill bit, yellow
7209237	Disposable Harvesting Set, 8.5, includes disposable chisel, tamp, and drill bit, red

### Made to Order Arthroscopic MOSAICPLASTY Guides

Requires the use of the Graft Placement Drill Guides, Dilators, and Delivery Tamps.

Reference #	Description
⚙️ 3134226	Drill Guide, AMP 4.5 mm with 5 mm slot at distal end
⚙️ 3134227	Drill Guide, AMP 6.5 mm with 5 mm slot at distal end

\* Item shown

⚙️ Special, Made to Order products are available to meet the individual needs of surgeons. Please appreciate that longer lead time for delivery should be expected. For more information, please contact your sales representative or Customer Service.

## Procedure Specific Solutions

### Triangular Fibrocartilage Complex



TFCC Mender Disposable Suture System

Reference #	Description
7210752	The TFCC Mender system is designed for repairing the TFCC under direct arthroscopic viewing.

## Procedure Specific Solutions

### Flexor Tendon Release – Trigger Finger System



#### Trigger Finger System

In conjunction with Yasushi Nakao, M.D., Smith & Nephew has developed an endoscopic approach to “flexor tendon release” for fingers and thumbs due to stenosing tenosynovitis.

Our minimally invasive approach is designed to decrease patient discomfort while incorporating the maximum safety element of releasing the A1 pulley under direct endoscopic vision. The system and technique combine to minimize patient risk commonly associated with conventional open or blind percutaneous techniques.

Reference	Description
7207698	Trigger Finger System

#### System includes

7207689	Cannula, Operative, 29 mm, short window
3807	Obturator, Conical, 2.9 mm, short
7207741	Cannula, Operative, 2.9 mm, long window
7207721	Obturator, Conical, 2.9 mm, short
7207697	Curved Blunt Dissector
7207875	Probe, 2.2 mm
7207696	Trigger Finger Sterilization Tray, 9" x 10" x 3"

#### Single Use Accessories

Reference	Description
7207690	Trigger Finger Retrograde Knife, yellow, sterile (6 per box)
7207693	Trigger Finger Triangle Knife, pumpkin, sterile (6 per box)
7207730	Cotton-Tipped Applicators, sterile, 20 packages of 5 each

## Procedure Specific Solutions

### Carpal Tunnel Ligament – ECTRA<sup>®</sup> II System



#### ECTRA II System – 25 mm

The Smith & Nephew ECTRA II systems permit the surgeon to access and release the carpal tunnel ligament endoscopically, allowing access via two portals for distal and proximal cutting, while minimizing endoscopic lens fogging with good air flow. ECTRA II offers the surgeon complete visualization and control. ECTRA knives permit the surgeon to determine both the direction and depth of the cut.

- Constant and complete visualization
- Simple tools eliminate mechanical malfunctions
- Also indicated for use in plantar fasciotomy and extra-articular lateral release
- Defined channel limits the cutting zone and assists the surgeon in protecting neurovascular structures
- Each system supplied with an instructional videotape

Reference #	Description
4119*	ECTRA II System, 25 mm

#### System includes

⚙️ 4139Z	Carpal Tunnel VideoEndoscope, 25 mm
4120	Slotted Cannula
4101	Blunt Dissector, curved
3856	Probe
4283	Palmar Arch Suppressor
4450	Hand Holder and Sterilization Tray with Cover
4141	Hand Strap
4432	Detachable Obturator Handle
4433	Conical Obturator
4434	Boat Nose Obturator
4435	Dissecting Obturator
4452	Ragnell Retractor (2 included with system)

\* Item shown

⚙️ Special, Made to Order products are available to meet the individual needs of our customers. Please contact your local representative. Call 1-800-343-5777 (US) or 1-800-343-5777 (Canada) for more information. Time for delivery should be expected. For more information, please contact your sales representative or Customer Service.

## Procedure Specific Solutions

### Carpal Tunnel Ligament Repair – ECTRA<sup>®</sup> II System

#### ECTRA II System – 35 mm

Reference	Description
4143	ECTRA II System, 35 mm

#### System includes

3896	Carpal Tunnel VideoEndoscope, 35 mm
4120	Slotted Cannula
4101	Blunt Dissector, curved
3856	Probe
4283	Palmar Arch Suppressor
4450	Hand Holder and Sterilization Tray with Cover
4141	Hand Strap
4432	Detachable Obturator Handle
4433	Conical Obturator
4434	Boat Nose Obturator
4435	Dissecting Obturator
4452	Ragnell Retractor (2 included with system)

#### ECTRA II System – Direct View

Reference	Description
4149	ECTRA II System, direct view

#### System includes

4144	Carpal Tunnel Endoscope
4120	Slotted Cannula
4101	Blunt Dissector, curved
3856	Probe
4283	Palmar Arch Suppressor
4450	Hand Holder and Sterilization Tray with Cover
4141	Hand Strap
4432	Detachable Obturator Handle
4433	Conical Obturator
4434	Boat Nose Obturator
4435	Dissecting Obturator
4452	Ragnell Retractor (2 included with system)

## Procedure Specific Solutions

### Carpal Tunnel Ligament Repair – ECTRA<sup>®</sup> II System

#### ECTRA II System without Endoscope

Reference #	Description
7204841	ECTRA II System without Endoscope

#### System includes

4120	Slotted Cannula
4101	Blunt Dissector, curved
3856	Probe
4283	Palmar Arch Suppressor
4450	Hand Holder and Sterilization Tray with Cover
4141	Hand Strap
4432	Detachable Obturator Handle
4433	Conical Obturator
4434	Boat Nose Obturator
4435	Dissecting Obturator
4452	Ragnell Retractor (2 included with system)



#### ECTRA II Obturator Set

Reference #	Description
4453	ECTRA II Obturator Set



#### Set includes

4433	Conical Obturator
4434	Boat Nose Obturator
4435	Dissecting Obturator
4432	Detachable Obturator Handle

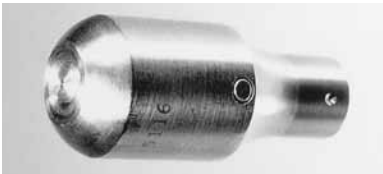

#### Other Components

Reference #	Description
3856	Probe, 3.0 mm
4101	Blunt Dissector, curved
4452	Ragnell Retractor



# Procedure Specific Solutions

## Carpal Tunnel Ligament Repair – ECTRA<sup>®</sup> II System

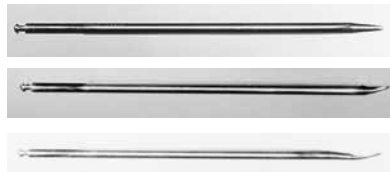

ECTRA II Obturator Set

Reference	Description
REF	Description
4453	ECTRA II Obturator Set



**Set includes:**

4433	Conical Obturator
4434	Boat Nose Obturator
4435	Dissecting Obturator
4432	Detachable Obturator Handle



Other Components

Reference	Description
3856	Probe, 3.0 mm
4101	Blunt Dissector, curved
4452	Ragnell Retractor
4120	Slotted Cannula
4283	Palmar Arch Suppressor
3896	Carpal Tunnel VideoEndoscope, 4 mm x 30°, 35 mm focal length
4144	Carpal Tunnel Endoscope, 4 mm x 30°
4450	Hand Holder and Sterilization Tray with Cover
4141	Hand Strap





## Procedure Specific Solutions

### Carpal Tunnel Ligament Repair – ECTRA<sup>®</sup> II System





#### ECTRA II Disposable Kit

Reference #	Description
4116	ECTRA II Disposable Kit

#### Each kit includes

8 Swabs, 3 Disposable Knives, 1 Hand Pad, sterile

#### Disposable Knives

	Reference #	Description
	4448	Triangle Knife, green, sterile (6 per box)
	4447	Probe Knife, beige, sterile (6 per box)
	4449	Retrograde Knife, blue, sterile (6 per box)

# ARTHROPAK

## Customized Procedure Kit



### ARTHROPAK Customized Procedure Kit

Smith & Nephew DYONICS® ARTHROPAK Customized Procedure Kits provide increased operational efficiencies and reduced supply expense. You customize your kit with your selection of disposable Smith & Nephew products for any arthroscopic procedure at a reduced cost.

- Free customized service
- Reduced product cost
- Save valuable time and demand on staff
- Streamlined ordering process
- Increased standardization
- Reduced inventory

DYONICS ARTHROPAK Customized Procedure Kits reduce the number of SKUs that need to be ordered and aggregate purchasing volume of arthroscopic products by enabling purchase from a single supplier. Please ask your local sales representative to demonstrate how DYONICS ARTHROPAK Customized Procedure Kits can benefit your practice.







### TRUFIT<sup>®</sup> CB Plug Synthetic Osteochondral Graft



- Off-the-shelf availability enables repair of small cartilage defects encountered during ACL surgery or meniscal repair
- Statistically significant clinical improvement\*
- Easy arthroscopic implantation technique

\* T Spalding, P Thompson, M Dhillon, and J Bird, "TRUFIT Plugs for Cartilage Repair in the Knee: 4 Year Results and Refining the Indications," ICRS 2010, Abstract 17.1.4.

(Not available in the U.S. or its territories)

---

### TRUFIT BGS Plug Bone Graft Substitute



- Porous scaffold for tissue growth
- Excellent osteoconductivity in critical-size defects at six months (ovine model)<sup>†</sup>
- Easy arthroscopic implantation technique

<sup>†</sup> Gao C, Gao J, You X, Huo S, Li X, Zhang Y, Zhang W, "Fabrication of Calcium Sulphate/ PLLA Composite for Bone Repair", J Biomed Mater Res Part A 73A (2005), 244-253.

<sup>†</sup> Pecora G, De Leonardis D, Ibrahim N, Bovi M, Cornelini R, "The Use of Calcium Sulphate in the Surgical Treatment of a 'Through and Through' Periradicular Lesion", International Endodontic J 34 (2001), 189-197.

(The safety and effectiveness of this device for use in osteochondral defects have not been established)

## Tissue Repair

### TRUFIT<sup>®</sup> CB Plug Kits

Smith & Nephew is focused on developing innovative tissue repair solutions for sports medicine indications. Utilizing a proprietary combination of polymers, ceramics and fibers, the material is designed to be a highly porous scaffold to support tissue incorporation and remodeling. By absorbing biologic fluids and nutrients, the material is biologically friendly.

Our tissue products on the following pages include the TRUFIT CB Plugs for cartilage repair and the TRUFIT BGS Plugs for use in filling bony voids or gaps caused by trauma or surgery that are not intrinsic to the stability of the bony structure. TRUKOR<sup>®</sup> Plus Instruments are for the preparation of precise circular sites for the TRUFIT BGS Plug or for preparation of the cartilage defect site for TRUFIT CB Plugs.

As innovators in tissue repair, Smith & Nephew will continue to develop products designed to reduce patient morbidity and improve patient outcomes.

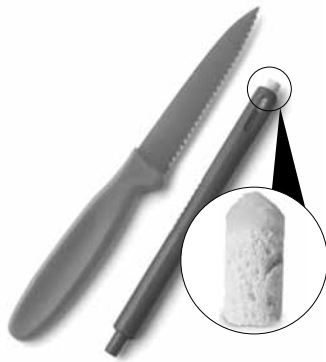

#### TRUFIT CB Plug Kits (plug, delivery device, trimming knife)

Reference #	Description
72200930	TRUFIT CB Plug – Size Code Green, 5 mm x 18 mm tall
72200931	TRUFIT CB Plug – Size Code Yellow, 6 mm x 18 mm tall
72200932	TRUFIT CB Plug – Size Code Red, 7 mm x 18 mm tall
72200933	TRUFIT CB Plug – Size Code Tan, 7.5 mm x 18 mm tall
72200934	TRUFIT CB Plug – Size Code Blue, 9 mm x 18 mm tall
72200935	TRUFIT CB Plug – Size Code Orange, 9.5 mm x 18 mm tall
72200936	TRUFIT CB Plug – Size Code Purple, 11 mm x 18 mm tall

#### TRUFIT CB Angle Plugs (plug, delivery device, trimming knife)

Reference #	Description
72201014	TRUFIT CB Angle Plug, Size Code Green, 5 mm x 18 mm tall
72201015	TRUFIT CB Angle Plug, Size Code Red, 7 mm x 18 mm tall
72201016	TRUFIT CB Angle Plug, Size Code Blue, 9 mm x 18 mm tall

**NOTE: Not available for distribution in the United States and its territories.**

## Tissue Repair

### TRUFIT<sup>®</sup> BGS Plug Kits



TRUFIT BGS Plug Kits (plug, delivery device, trimming knife)

Reference #	Description
72200923	TRUFIT BGS Plug – Size Code Green, 5 mm x 18 mm tall
72200924	TRUFIT BGS Plug – Size Code Yellow, 6 mm x 18 mm tall
72200925	TRUFIT BGS Plug – Size Code Red, 7 mm x 18 mm tall
72200926	TRUFIT BGS Plug – Size Code Tan, 7.5 mm x 18 mm tall
72200927	TRUFIT BGS Plug – Size Code Blue, 9 mm x 18 mm tall
72200928	TRUFIT BGS Plug – Size Code Orange, 9.5 mm x 18 mm tall
72200929	TRUFIT BGS Plug – Size Code Purple, 11 mm x 18 mm tall

**NOTE: The safety and effectiveness of this device for use in osteochondral defects have not been established.**



## Tissue Repair

### TRUKOR® Plus Instruments and Drill Sleeves



#### TRUKOR Plus Site Preparation Kit

Reference #	Description
72200965	TRUKOR Plus Site Preparation Kit (Contains Sterilization Tray, Drills, Universal Drill Handle, Caps, Sizers, Depth Gauge and Obturators)

#### Kit Includes

72200964	TRUKOR Plus Instrument Sterilization Tray
72200954	TRUKOR Plus Drill – Size Code Green, 5 mm
72200955	TRUKOR Plus Drill – Size Code Red, 7 mm
72200956	TRUKOR Plus Drill – Size Code Blue, 9 mm
72200957	TRUKOR Plus Drill – Size Code Purple, 11 mm
72200962	TRUKOR Plus Universal Drill Handle
72200941	TRUKOR Drill Sleeve Cap – Size Code Green, 5 mm
72200942	TRUKOR Drill Sleeve Cap – Size Code Red, 7 mm
72200943	TRUKOR Drill Sleeve Cap – Size Code Blue, 9 mm
72200944	TRUKOR Drill Sleeve Cap – Size Code Purple, 11 mm
72200949	TRUKOR Obturator – Size Code Green, 5 mm
72200950	TRUKOR Obturator – Size Code Red, 7 mm
72200951	TRUKOR Obturator – Size Code Blue, 9 mm
72200952	TRUKOR Obturator – Size Code Purple, 11 mm
72200958	TRUKOR Plus Sizer – Size Code Green, 5 mm
72200959	TRUKOR Plus Sizer – Size Code Red, 7 mm
72200960	TRUKOR Plus Sizer – Size Code Blue, 9 mm
72200961	TRUKOR Plus Sizer – Size Code Purple, 11 mm
72200963	TRUKOR Plus Depth Gauge



#### TRUKOR Instruments - Drill Sleeves

Reference #	Description
72200937	TRUKOR Drill Sleeve – Size Code Green, 5 mm, disposable
72200938	TRUKOR Drill Sleeve – Size Code Red, 7 mm, disposable
72200939	TRUKOR Drill Sleeve – Size Code Blue, 9 mm, disposable
72200940	TRUKOR Drill Sleeve – Size Code Purple, 11 mm, disposable





**DYONICS®  
PLATINUM**  
Series Blades



Each single-use blade is designed to deliver superior

- Resection
- Debris evacuation
- Sharpness

---

**DYONICS  
HIGH VISIBILITY**  
Hi



Unique, narrow neck sheath design improves visualization of the surgical site

- See more anatomical landmarks
- Sculpt offending acetabular overhang
- Aggressive side-cutting and gentle end-cutting

## Single-use Blades

### DYONICS<sup>®</sup> PLATINUM Series Blades



Each single-use DYONICS PLATINUM Series Blade is designed to deliver superior resection, debris evacuation and sharpness as compared to our traditional and key competitive blades, helping busy arthroscopists operate efficiently.

Note: All DYONICS PLATINUM Series Blades require the DYONICS POWERMAX<sup>®</sup> ELITE Handpiece. Reference #s 72200616, 72200617 and 72200872 on page G-2.



#### DYONICS BONECUTTER<sup>®</sup> PLATINUM Blades

Packaged 6 per box, sterile

BONECUTTER PLATINUM Blades resect soft tissue and bone with one blade. Unique PLATINUM technology combines a new fortified alloy with SURILLIUM<sup>®</sup> coating to enable operating speeds up to 10,000 RPM, for durable and aggressive subacromial decompression and ACL site preparation.

Reference #	Description	Latch Color
72202534	3.5 mm BONECUTTER PLATINUM Blade	White
72202531	4.5 mm BONECUTTER PLATINUM Blade	Yellow
72202530	5.5 mm BONECUTTER PLATINUM Blade	Orange



#### DYONICS INCISOR<sup>®</sup> Plus PLATINUM Blades

Packaged 6 per box, sterile

DYONICS INCISOR Plus PLATINUM Blades feature a precision-sharpened, tooth-to-tooth design which facilitates aggressive resection of tough soft tissue such as the ACL stump.

Reference #	Description	Latch Color
73303518	3.5 mm INCISOR Plus PLATINUM Blade	Beige
72202530	4.5 mm INCISOR Plus PLATINUM Blade	Slate
72203519	5.5 mm INCISOR Plus PLATINUM Blade	Lavender

## Single-use Blades

### DYONICS® PLATINUM Series Blades

DYONICS Full Radius PLATINUM Blades

Packaged 6 per box, sterile

DYONICS Full Radius PLATINUM Blades feature a wide cutting mouth and toothed inner blade to help efficiently grab and resect frayed tissue such as bursa and torn rotator cuff.



Reference #	Description	Latch Color
72203520	3.5 mm Full Radius PLATINUM Blade	White
72203521	4.5 mm Full Radius PLATINUM Blade	Yellow
72203522	5.5 mm Full Radius PLATINUM Blade	Orange

---

## Single-use Blades

### DYONICS<sup>®</sup> ELECTROBLADE<sup>®</sup> Resector



DYONICS ELECTROBLADE Resectors simultaneously resect tissue and coagulate bleeding vessels, to help increase procedure efficiency and maintain visual clarity throughout the procedure. In addition, the bipolar design eliminates the need for a ground pad.

The BONECUTTER<sup>®</sup> ELECTROBLADE Resector is the first all-in-one device for subacromial decompression. A unique SURILLIUM<sup>®</sup> coating maintains blade durability and cutting efficiency throughout a procedure. Resector operates at speeds up to 8,000 RPM.

#### DYONICS ELECTROBLADE Resectors

Packaged 3 per box, sterile

Reference #	Description	Latch Color
72202213	4.5 mm DYONICS BONECUTTER ELECTROBLADE	Yellow
7205962	5.5 mm DYONICS BONECUTTER ELECTROBLADE Resector compatible with the VULCAN <sup>®</sup> Generator (requires the VULCAN Generator Adapter) and the Erbe Generator	Orange
7210380	VULCAN Generator Adapter (required to operate 7205962, packaged non-sterile, reusable)	
7205961	4.5 mm Full Radius, Valleylab Generator-compatible Compatible with the Valleylab*, Erbe <sup>†</sup> and VULCAN Generators (when used with the VULCAN Generator Adapter)	Yellow
7209855	4.5 mm Full Radius, VULCAN Generator-compatible	Yellow
7209700	4.5 mm ELITE, Full Radius, Valleylab Generator-compatible Compatible with the Valleylab*, Erbe <sup>†</sup> and VULCAN Generators (when used with the VULCAN Generator Adapter)	Maroon
7209983	4.5 mm ELITE, VULCAN Generator-compatible	Maroon

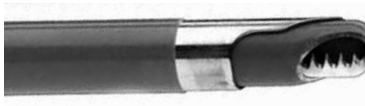
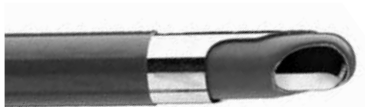

\* Valleylab Generator models are the Valleylab Force FX(tm) and Force(tm) 2;

† Erbe Generators are the Erbe 300 and 350. Requires Erbe Adapter #20183-022 - available through Erbe.

## Single-use Blades

### DYONICS® BONECUTTER® Blades



#### DYONICS BONECUTTER Blades

Packaged 6 per box, sterile

BONECUTTER Blades resect both soft tissue and bone with a single blade, eliminating the need to switch from a straight blade to a burr. Proprietary SURILLIUM® coating helps maintain blade sharpness and durability throughout a procedure where tissue and bone resection are desired, such as subacromial decompression and ACL site preparation. Standard BONECUTTER Blades operate at speeds up to 8,000 RPM.

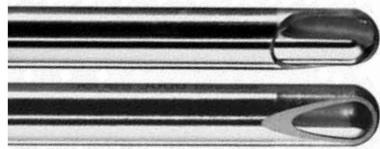

Reference #	Description	Latch Color
7210486	3.5 mm Full Radius BONECUTTER	Beige
7206011	4.5 mm Full Radius BONECUTTER	Yellow
7206010	5.5 mm Full Radius BONECUTTER	Orange



7206013	4.5 mm SYNOVATOR® w/Full Radius inner BONECUTTER	Forest green
7206012	5.5 mm SYNOVATOR w/Full Radius inner BONECUTTER	Melon yellow

## Single-use Blades





### DYONICS<sup>®</sup> ORBIT<sup>®</sup> Curved Blades



DYONICS ORBIT Curved Blades

Packaged 6 per box, sterile

- Unique cutting window can be rotated up to 360° while in the joint
- Allow for convex and concave blade orientation
- Eliminate the need for removing and bending blades
- Curve length 17 mm

	Power/EP-1 <sup>®</sup> REF	Ultra Series REF*	Description	Latch Color
	7205320	7209029	4.5 mm ORBIT INCISOR <sup>®</sup>	Lime green
	7205321	7209030	4.5 mm ORBIT SYNOVATOR <sup>®</sup>	Forest green
	7205322	7209031	4.5 mm ORBIT RAZORCUT <sup>®</sup>	Pink
	7205323	7209028	4.5 mm ORBIT Full Radius	Yellow
	7210719	N/A	4.5 mm ORBIT Full Radius ELITE	Maroon
	7205687	7209032	4.5 mm ORBIT INCISOR Plus	Violet

\* Ultra Series blades are compatible with the DYONICS POWER UltraLight Handpiece only (REF 7205971 pg. G-2)



## Single-use Blades

### DYONICS® Curved Blades

#### DYONICS Curved Blades

All curve lengths 17 mm, packaged 6 per box, sterile.



Power/EP-1® REF	Ultra Series REF	Description	Latch Color
7211033	N/A	4.5 mm concave, curved, TURBOWHISKER® Blade	Navy blue
7205332	7209026	4.5 mm concave, curved, INCISOR®	Lime green
7205334	7209027	4.5 mm concave, SYNOVATOR®	Forest green
7210980	N/A	3.5 mm concave, Full Radius	Beige
7205349	7209025	4.5 mm concave, Full Radius, curve	Yellow
7210988	N/A	4.5 mm concave, Full Radius ELITE	Maroon
72200036	N/A	4.5 mm INCISOR Plus ELITE	Slate
7209075	N/A	4.5 mm concave, curved INCISOR Plus	Violet

## Single-use Blades

### DYONICS® Straight Blades





DYONICS Straight Blades  
Packaged 6 per box, sterile

	Power/EP-1° REF	Description	Latch Color
	7205316	4.5 mm TURBOWHISKER®	Navy blue
	7209303	4.5 mm Ultra Series TURBOWHISKER	Navy blue
	7205312	3.5 mm INCISOR®	Medium grey
	7209489	4.0 mm INCISOR	Violet
	7205313	4.5 mm INCISOR	Lime green
	7205314	5.5 mm INCISOR	Mocha
	7205310	4.5 mm SYNOVATOR®	Forest green
	7205311	5.5 mm SYNOVATOR	Melon yellow
	7209077	4.5 mm SYNOVATOR outer with Full Radius inner	Clear
	7205317	3.5 mm RAZORCUT®	Purple
	7205318	4.5 mm RAZORCUT	Pink
	7205319	5.5 mm RAZORCUT	Light pink
	7205308	3.5 mm Cutter	Red
	7205309	4.5 mm Cutter	Blue
	7205685	4.5 mm TURBOCUTTER® II	Sage Green

## Single-use Blades

### DYONICS® Straight Blades







DYONICS Straight Blades  
Packaged 6 per box, sterile

	Power/EP-1® REF	Description	Latch Color
	7205305	3.5 mm Full Radius	Beige
	7205306	4.5 mm Full Radius	Yellow
	7205307	5.5 mm Full Radius	Orange
	7210751	3.5 mm Full Radius ELITE	Beige
	7210499	4.5 mm Full Radius ELITE	Maroon
	7210909	5.5 mm Full Radius ELITE	Olive
	7205315	4.5 mm TURBOTRIMMER	Powder blue
	7205345	4.5 mm INCISOR® Plus	Violet
	7205459	5.5 mm INCISOR Plus	Teal
	72200095	3.5 mm INCISOR Plus ELITE	White
	7210976	4.5 mm INCISOR Plus ELITE	Slate
	72200081	5.5 mm INCISOR Plus ELITE	Lilac
	7209211	3.2 Chondroplasty Blade	

## Single-use Burrs

### DYONICS<sup>®</sup> Straight Burrs

DYONICS Straight Burrs  
Packaged 6 per box, sterile

	Power/EP-1 <sup>°</sup> REF (Wide Mouth)	Description	Latch Color	Maximum RPM
	7205324	4.0 mm Abrader	Aqua	8,000
	7205325*	5.5 mm Abrader	Black	8,000
	72200722 <sup>†</sup>	4.0 mm ELITE Abrader	Aqua	10,000
	72200723 <sup>†</sup>	5.5 mm ELITE Abrader	Black	10,000
	7205326	4.0 mm Acromionizer	Mauve	8,000
	7205327*	5.5 mm Acromionizer	Brown	8,000
	72200724 <sup>†</sup>	4.0 mm ELITE Acromionizer	Mauve	10,000
	72200725 <sup>†</sup>	5.5 mm ELITE Acromionizer	Brown	10,000
	7205330	4.0 mm STONECUTTER <sup>°</sup>	Maroon	8,000
	7205331*	5.5 mm STONECUTTER	Olive	8,000
	72200728 <sup>†</sup>	4.0 mm ELITE STONECUTTER	Maroon	10,000
	72200729 <sup>†</sup>	5.5 mm ELITE STONECUTTER	Olive	10,000
	7205328	4.0 mm NOTCHBLASTER <sup>°</sup>	Lilac	8,000
	7205329*	5.5 mm NOTCHBLASTER	Peach	8,000
	72200726	4.0 mm ELITE NOTCHBLASTER	Lilac	10,000
	72200727	5.5 mm ELITE NOTCHBLASTER	Peach	10,000
	7205668	4.0 mm ACROMIOBLASTER	Sage green	8,000
	7205669*	5.5 mm ACROMIOBLASTER	Brick red	8,000
	72200730 <sup>†</sup>	4.0 mm ELITE ACROMIOBLASTER	Sage green	10,000
	72200731 <sup>†</sup>	5.5 mm ELITE ACROMIOBLASTER	Brick red	10,000
	7209335*	4.5 mm Shielded	White	8,000
	6900988	4.0 mm Tapered	Clear	8,000
	7205727*	4.5 mm HELICUT <sup>°</sup>	Slate	5,000

\* Item shown

<sup>†</sup> Requires the DYONICS POWERMAX ELITE Handpiece. Reference #s 72200616, 72200617 and 72200872 on page G-2.

## Hip Shaver Blades and Burrs

DYONICS<sup>®</sup> High Visibility and Extended Length Blades and Burrs



### DYONICS HIGH VISIBILITY Hip Burrs

Packaged 3 per box, sterile



Reference #	Description	Latch Color
72203127*	5.5 mm HIGH VISIBILITY Sheath Abrader Burr	Black
72203128	4.0 mm HIGH VISIBILITY Sheath Abrader Burr	Purple
72203129*	5.5 mm HIGH VISIBILITY Sheath Flat Top Burr	Black
72203130	4.0 mm HIGH VISIBILITY Sheath Flat Top Burr	Purple
72203131*	5.5 mm HIGH VISIBILITY Sheath Barrel Burr	Black
72203132	4.0 mm HIGH VISIBILITY Sheath Barrel Burr	Purple



### DYONICS POWER Shaver Burrs, 18 cm working length, partial hood.

Packaged 3 per box, sterile

Reference #	Description
72200080*	4.0 mm Long Abrader
72200082*	5.5 mm Long Abrader



### DYONICS POWER Shaver Blades, 18 cm working length

Packaged 3 per box, sterile

Reference #	Description
72200414*	4.5 mm Long INCISOR <sup>®</sup> Plus ELITE
72200494*	4.5 mm Long Curved INCISOR Plus ELITE
7205335*	4.5 mm Long Curved Full Radius Concave
7205336	4.5 mm Long Curved Full Radius Convex
7205341*	4.5 mm Long Full Radius
7205343*	4.5 mm Long INCISOR
7210979*	4.5 mm Long BONECUTTER <sup>®</sup>
6900678*	5.5 mm Long Full Radius

\* Item shown

## Single-use Extremity Blades and Burrs

### DYONICS<sup>®</sup> POWERMINI<sup>®</sup> Small Joint Shaver System



DYONICS POWERMINI Shaver Blades and Burrs are designed exclusively for the POWERMINI Shaver Handpiece (REF 72201500 and REF 72201503 pg. G-2). All blades are 7 cm in length.

#### DYONICS POWERMINI Blades

Packaged 6 per box, sterile



Reference #	Description	Latch Color
72201504*	2.0 mm TURBOWHISKER <sup>®</sup>	Yellow
72201505	2.9 mm TURBOWHISKER	Green
72201506*	2.9 mm Cutter	Beige
72201507*	2.0 mm Full Radius	Blue
72201509	2.9 mm Full Radius	Red
72201510	3.5 mm Full Radius	Plum
72201517	3.5 mm Full Radius, BONECUTTER <sup>®</sup>	Plum
72201512*	3.5 mm RAZORCUT <sup>®</sup>	Pumpkin/orange
72201513	2.9 mm INCISOR <sup>®</sup> Plus ELITE	Peach
72201514*	3.5 mm INCISOR Plus ELITE	Sage green
72201515 <sup>†</sup>	3.5 mm curved INCISOR Plus ELITE	Sage green



#### DYONICS POWERMINI Burrs

Packaged 6 per box, sterile



Reference #	Description	Latch Color
72201518*	2.9 mm Abrader	Orange
72201519	3.5 mm Abrader	Aqua
72201520*	2.9 mm Barrel Burr	Purple

\* Item shown

† Product availability is subject to change. Please contact your sales representative or Customer Service for more information.

# Single-use Extremity Blades and Burrs

## Mini Blades and Burrs





### Mini Blades

Indicated for use with the Smith & Nephew DYONICS® POWER/EP-1® Mini Motor Drive (REF 7205357 pg. D-12) in small joint arthroscopy. All blades listed below are 7 cm in length unless otherwise specified. Packaged 6 per box, sterile.

	Power/EP-1 REF	Description	Hub Color
	3606*	2.9 mm Cutter	Beige
	3407*	2.0 mm TURBOWHISKER	Yellow
	3418	2.9 mm TURBOWHISKER	Green
	3410*	2.0 mm Full Radius	Blue
	3419	2.9 mm Full Radius	Red
	6900927	3.5 mm Full Radius, BONECUTTER®	Black
	7205474	3.5 mm Full Radius, 8 cm	Plum
	7210488	3.5 mm Full Radius curved, concave, 8 cm	Brick red
	4224*	3.5 mm RAZORCUT®	Pink
	7205477	3.5 mm RAZORCUT, 8 cm	Pumpkin/orange
	4225*	3.5 mm INCISOR®	Turquoise
	7209065	2.9 mm INCISOR	Lime green
	7209085	2.0 mm INCISOR	Navy blue
	7205558	3.5 mm INCISOR, curved, concave, 8 cm	Sage
	7205476	3.5 mm INCISOR Plus, 8 cm	Sage green

### Mini Burrs

Packaged 6 per box, sterile

	Power/EP-1 REF	Description	Hub Color
	3553*	2.9 mm Barrel Abrader	Purple
	3530*	2.9 mm Abrader	Orange
	3819	3.5 mm Abrader	Aqua

## Single-use Blades and Burrs

### Short Sheath and Obturator Components

Short Sheath and Obturator  
Packaged 6 per box, sterile

Power/EP-1° REF	Description	Latch Color
7205468	4.0 mm Short Sheath and obturator handle	Maroon
7205470	5.5 mm Short Sheath and obturator handle	Olive



Short Sheath and Obturator Components

Reusable Obturator and Replacement O-rings: DYONICS® POWER/EP-1.

Packaged 12 per box

Power/EP-1 REF	Description
7205458	Reusable O-rings, 4.0 mm
7205457	Reusable O-rings, 5.5 mm

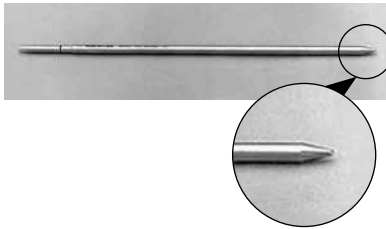

7205456	Reusable obturator, 4.0 mm
7205455	Reusable obturator, 5.5 mm





**DYONICS<sup>®</sup>**  
**POWERMAX<sup>®</sup> ELITE**  
Handpiece



- Combination of high torque and speed with a lightweight design
- Responds quickly to variations in tissue and bone
- Easy access controls and suction lever

---

**DYONICS POWER II**  
Shaver System



- Combines the most aggressive arthroscopic soft tissue resection with powerful torque
- Efficient bone removal
- Compatible with all DYONICS POWER handpieces and footswitches

## DYONICS<sup>◇</sup> POWER Shaver Systems

### DYONICS POWER II Shaver Control System



The high-performance DYONICS POWER II Shaver Control Unit offers two unique, customizable oscillate modes for efficient soft tissue resection; dual hot ports for simultaneous shaver and powered instrument operation; and an integrated flush lavage feature to rapidly clear the visual field of debris.

Reference #	Description
72200873	DYONICS POWER II Shaver System Control Unit (Control Unit only). All units 100-240 VAC, 50/60 Hz

#### DYONICS POWER II Shaver Control System Country Kits

Country Kits include a control unit, footswitch, power cord, operations manual and diagnostic tray label.

Reference #	Description
72201029	Country Kit, US
72201033	Country Kit, UK
72201036	Country Kit, German
72201040	Country Kit, Spanish
72201042	Country Kit, French
72201045	Country Kit, Italian
72201048	Country Kit, Swedish
72201051	Country Kit, Dutch
72201054	Country Kit, Portuguese
72201060	Country Kit, Norwegian
72201321	Country Kit, Korean

# DYONICS<sup>®</sup> POWER Shaver Systems

## DYONICS Shaver Handpieces

For use with DYONICS POWER, DYONICS POWER II and EP-1<sup>°</sup> Control Units

	Reference #	Description
	72200616*	DYONICS POWERMAX <sup>®</sup> ELITE Handpiece with blade multi-positioning, hand controls, suction lever, 10 ft (3 m) cord
	72200617*	DYONICS POWERMAX ELITE Handpiece with blade multi-positioning, no hand controls, suction lever, 10 ft (3 m) cord
	72200872	DYONICS POWERMAX ELITE Handpiece hand-controlled with opposite-side suction lever and stiffer buttons
	72201500†	POWERMINI <sup>®</sup> Small Joint Handpiece with blade multi-positioning, hand controls, suction lever, 10 ft. (3m) cord <b>For use with DYONICS POWER II Control System.</b>
	72201503†	POWERMINI Small Joint Handpiece with blade multi-positioning, no hand controls, suction lever, 10 ft. (3m) cord <b>For use with DYONICS POWER II Control System.</b>
	7205357	DYONICS Mini-motor Handpiece, suction lever, 10 ft (3 m) cord
	7205971‡	DYONICS POWER Ultralight Handpiece, suction lever, 10 ft (3 m) cord

\* Handpieces accept all blades

† Handpieces only work with the Single-use Extremity Blades and Burrs listed on page D-11 and F-11.

‡ Handpiece accepts all straight blades, but only ULTRA series curved blades.

## DYONICS<sup>®</sup> POWER Shaver Systems Accessories



### DYONICS POWER Footswitches

Low profile, cutting mode and blade window lock control, 12 ft (3.6 m) cord

Reference #	Description
-------------	-------------

7205399	DYONICS POWER Footswitch, low profile, on/off
---------	---



Pedal-style, 12 ft (3.6 m) cord

Reference #	Description
-------------	-------------

7205396	DYONICS POWER Footswitch, pedal-style, on/off
---------	---



### DYONICS POWER II Footswitch

Reference #	Description
-------------	-------------

72201092	Pedal-style, on/off or variable speed. <b>Operates with DYONICS POWER II Shaver System Control Unit (REF 72200873) only</b>
----------	---

### Sterilization Tray

Reference #	Description
-------------	-------------

7205683	Sterilization Tray for DYONICS Shaver Handpieces (motor drives) (20"L x 9"W x 2"H), includes silicon mats
---------	---

### Communication Cables

Reference #	Description
-------------	-------------

72203139	DYONICS POWER Interface Cable B (used for communication between DYONICS POWER Control Unit or DYONICS POWER II Control Unit and Mitek <sup>™</sup> fms duo <sup>™</sup> + using Mitek 4-Way Pedal Board)
72203140	DYONICS POWER II Interface Cable C (used for communication between DYONICS POWER II Control Unit, using either the DYONICS POWER II Footswitch or DYONICS Shaver Handpieces with hand controls, and Mitek fms duo+)
72203594	DYONICS POWER Interface Cable E (used for communication between DYONICS POWER II Control Unit and Mitek Nextra <sup>™</sup> Shaver System)
91000973	DYONICS POWER II Interface Cable (used for communication with DYONICS 25 Pump)

## DYONICS<sup>◇</sup> POWER Shaver Systems

### Replacement Parts



Replacement Motor Drive Cord

Reference #	Description
7208207	Replacement Motor Drive Cord for DYONICS POWER handpieces (REF 7205354) and (REF 7205355), standard or hand control type. <i>Not for use with POWERMAX<sup>◇</sup> or POWERMAX ELITE.</i>

*NOTE: For standard and POWERMAX Handpieces use 8101720 O-Ring.*

#### Replacement power cords and connectors

Reference #	Description
7205081	AC Power Cord for DYONICS POWER and EP-1 <sup>◇</sup> Shaver Control Units, 3 ft (90 cm), 120 VAC
4428	AC Power Cord for DYONICS POWER and EP-1 Shaver Control Units, 12 ft (3.6 m), 120 VAC
4476	AC Power Cord for DYONICS POWER and EP-1 Shaver Control Units, 3.25 ft (1 m), 230 VAC
7205393	Handpiece Connector, DYONICS POWER and EP-1 Control Unit, replacement
7205394	Footswitch Connector, DYONICS POWER and EP-1 Control Unit, replacement
8101109	Crimp (order 2)
8102581	Lanyard

#### Replacement Caps and Lanyards

The table below will assist you in ordering replacement caps and lanyards. There are three (3) shaver handpiece motor drive cords, therefore, it is important that you reference the serial number on the motor drive cord to the table below to ensure that the proper replacement cap and lanyard is ordered.

System	Description	Replacement REF	Cable Serial Numbers	IFU
DYONICS POWER and EP-1	MDU motor cord (SCREW-ON TYPE)	7205902, 8100001	TJ 5524 and HIGHER	1060809
DYONICS POWER and EP-1	MDU motor cord (SCREW-ON TYPE)	7205903, 8101765	TJ 2860 to TJ 5523	
DYONICS POWER and EP-1	MDU motor cord (PUSH-ON CAP)	8101544*	TJ 0000 to TJ 2859	
DYONICS POWER and EP-1	FOOTSWITCH cord	8100002	ALL	
PS3500EP	MDU motor cord	8101724	ALL	
Ultralight	MDU motor cord (SCREW-ON TYPE)	7205902, 8100001	TJ 5524 and HIGHER	1060809

#### Replacement Motor Drive Cords

Reference #	Description
7208208	Replacement Motor Drive Cord for DYONICS POWER and EP1 Mini Motor Drive
7209071	Replacement Motor Drive Cord for DYONICS POWER Ultralight Motor Drive

\* NOTE: Soak cap 8101544 does not include lanyard







**DYONICS® POWER**  
Instrumentation and Accessories

H



- Cordless and corded options
- Wide variety of blades and accessories



## DYONICS<sup>◇</sup> POWER Instrumentation

### Battery Operated Power Equipment



Battery Operated Power Equipment

Reference #	Description
2851	450 Drill, with battery, 1/4" Jacobs Chuck

NOTE: 650 RPM, will accept 1/4" drill bit



Reference #	Description
2855	Sagittal Saw, with battery

NOTE: 850 RPM



Reference #	Description
2856	800 Wire Driver, with battery

NOTE: 800 RPM, will accommodate 0.7 mm–1.16 mm or 0.025"–0.062"

## Accessories

### Charger, Power Pack and Chuck Key



Charger, Power Pack and Chuck Key

Reference #	Description
2863	Pac II Battery, 6.0 VDC (2 per box)



Reference #	Description
3082	MPC IV Charger, 110 VAC*



Reference #	Description
3438	Jacobs Chuck Key

\* Batteries not included with charger

## Accessories

### Sterile, Disposable Saw Blades†

Sterile, Disposable Saw Blades  
For use with Sagittal Saw, REF 2855

Reference #	Description
3701	Saw Blade – Standard, thickness: 0.65 mm, length: 63 mm, width: 32 mm (6 per box)
3702	Saw Blade – Standard, thickness: 0.89 mm, length: 63 mm, width: 32 mm (6 per box)
3703	Saw Blade – Short, thickness: 0.65 mm, length: 29 mm, width: 15 mm (6 per box)
3704	Saw Blade – Short, Narrow, thickness: 0.65 mm, length: 29 mm, width: 9 mm (6 per box)
3705	Saw Blade – Narrow, thickness: 0.65 mm, length: 63 mm, width: 13 mm (6 per box)
3706	Saw Blade – Long, special thickness: 0.89 mm, length: 68 mm, width: 19 mm (6 per box)

† All saw blades have graduated markings every 5.0 mm

## DYONICS<sup>®</sup> POWER Instrumentation

### Corded Power Equipment

#### Corded Power Equipment

For use with DYONICS POWER Control Unit (see pg. G-1). The drill's design and choice of modular accessories provide smooth switching of components during arthroscopic surgery. For the sagittal saw, you may choose from multiple blades with varying sizes.

#### Sterilization Parameters

Steam, prevacuum (wrapped or unwrapped)

Temperature: 132°C

Time: 4-min.

Dry time: 8-min.

Steam, gravity (wrapped or unwrapped)

Temperature: 132°C

Time: 35-min.

Dry time: 8-min.



Reference #	Description
7205785	Pistol Grip Drill (requires REF 7205788)
8104908	Wire Guard



7205786	Inline Sagittal Saw (requires REF 7205788)
---------	--



7205791	Sagittal Saw Module (used with REF 7205785)
---------	---



72202428	Sterilization Tray (holds all components including drill and saw)
----------	---

## DYONICS<sup>◇</sup> POWER Instrumentation

### Corded Power Equipment

## Instrumentation

	Reference #	Description
	7209391	DYONICS POWER high-speed drill (model 6100)
	7209394	DYONICS POWER oscillating saw, MicroAire™ interface (model 6710)
	7209392	DYONICS POWER reciprocating saw, MicroAire interface (model 6420)
	7209395	DYONICS POWER heavy-duty oscillating saw, MicroAire interface (model 6740)
	8103998	DYONICS POWER locking wrench
	7209393	DYONICS POWER Synthes chuck

## Accessories

### Wire Driver, Pin Driver, Chucks and Cable



Wire Driver, Pin Driver, Chucks and Cable  
For use with DYONICS® POWER Control Unit.

Reference #	Description
7205789	Automatic Wire Driver (accepts wires up to 1.6 mm)



7205790	Automatic Pin Collet (accepts pins up to 3.2 mm)
---------	--



7205792	Jacobs Chuck, 5/32"
8104907	Chuck Key



7205793	Jacobs Chuck, keyless, 1/8"
---------	-----------------------------



7205794	Jacobs Chuck, 1/4"
3438	Chuck Key



7205795	Jacobs Chuck, keyless, 1/4"
---------	-----------------------------



7205788	Power Cable (from drill and/or sagittal saw to control)
---------	---

## Accessories

### Disposable Saw Blades for DYONICS<sup>®</sup> POWER Instrumentation

Disposable Saw Blades for DYONICS POWER Instrumentation

For use with Sagittal Saws REF 7205786 or 7205791. Disposable, packaged 6 per box, sterile.



Reference #	Description
7209396	DYONICS sagittal saw blade, 5.8 mm x 12 mm x 0.4 mm, with straight fine teeth, no etchings, depth stop



7209397	DYONICS sagittal saw blade, 5.8 mm x 18 mm x 0.4 mm, with straight fine teeth with markings, depth stop
---------	---

#### Sagittal Saw Blades (WxLxT)

For use with Sagittal Saws REF 7205786 or 7205791. Disposable, packaged 6 per box, sterile.



Reference #	Description
7205809	Saw Blade, 9.4 mm x 15 mm x 0.4 mm, with 15 mm depth stop, titanium nitride finish, no etching

#### Sagittal Saw Blades with Depth Stops

For use with Sagittal Saws REF 7205786 or 7205791. Disposable, packaged 6 per box, sterile.



Reference #	Description
7205807	Saw Blade, 9.4 mm x 10 mm x 0.4 mm, with 10 mm depth stop, titanium nitride finish, no etching



7205808	Saw Blade, 9.4 mm x 12 mm x 0.4 mm, with 12 mm depth stop, titanium nitride finish, no etching
---------	--



7205898	Saw Blade, 9.4 mm x 10 mm x 0.4 mm, with 10 mm depth stop, without titanium nitride finish, no etching
---------	--



7205899	Saw Blade, 9.4 mm x 12 mm x 0.4 mm, with 12 mm depth stop, without titanium nitride finish, no etching
---------	--



7205900	Saw Blade, 9.4 mm x 15 mm x 0.4 mm, with 15 mm depth stop, without titanium nitride finish, no etching
---------	--







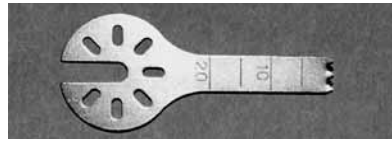

## Accessories

### Calibrated Sagittal Saw Blades

Calibrated Sagittal Saw Blades (WxLxT)

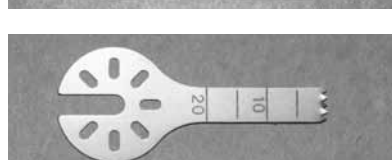
For use with Sagittal Saws REF 7205786 or 7205791. Disposable, packaged 6 per box, sterile.

	Reference #	Description
	7205802	Saw Blade, 19.1 mm x 25.4 mm x 0.4 mm, with markings
	7205803	Saw Blade, 5.8 mm x 25.4 mm x 0.4 mm, with markings
	7205804	Saw Blade, fine teeth, 9.4 mm x 25.5 mm x 0.4 mm, with markings
	7205805	Saw Blade, 9.4 mm x 25.5 mm x 0.4 mm, with markings
	7205806	Saw Blade, 4.5 mm x 25.5 mm x 0.4 mm, with markings
	7205895	Saw Blade, 19.1 mm x 25.4 mm x 0.4 mm, with markings and titanium nitride finish
	7205896	Saw Blade, 5.8 mm x 25.4 mm x 0.4 mm, with markings and titanium nitride finish
	7205897	Saw Blade, fine teeth, 9.4 mm x 25.5 mm x 0.4 mm, with markings and titanium nitride finish





**DYONICS° RF-S  
WHIRLWIND**

90° Probe



- Powerful high-flow suction aids in rapid tissue removal
- Provides unobstructed image
- Indicated for multiple procedures

---

**DYONICS EFLEX°**

Radiofrequency Probes



- Enable access to multiple zones in the hip joint
- Probes can deflect up to 100°
- Multiple configurations facilitate access

# DYONICS<sup>◇</sup> RF Arthroscopy System

## DYONICS RF System



### DYONICS RF System

Smith & Nephew is proud to present a variety of RF options to meet the specialized needs of today's arthroscopist. The DYONICS RF Radiofrequency System is designed for arthroscopic surgeons who need to rapidly resect and sculpt soft tissue and coagulate bleeding vessels. Patented bipolar technology emphasizes a high degree of control, while maximizing speed and efficiency of tissue removal.

Reference #	Description
72202149*	DYONICS RF System System includes: DYONICS RF generator, foot pedal and power cord



### Accessories

72202151*	Foot pedal
72202491	Accessory Kit includes IFU and US power cord
72202462	Accessory Kit includes IFU and European standard 2-prong power cord
72202916	Biomedical Output Test Part (for use with biomedical test procedure)



NOTE: Only compatible with DYONICS RF System and DYONICS RF System Probes

# DYONICS<sup>®</sup> RF Arthroscopy System

## DYONICS RF System Probe Indications

High-performance DYONICS RF probes are designed to deliver rapid resection and precision sculpting of soft tissue. Large surface areas ensure quick tissue removal and cutting, while the patented bipolar technology delivers precisely focused energy to the targeted tissue. Probes are available in a variety of angle and electrode configurations, ideal for shoulder and knee procedures.

	SUCTION PROBES				NON-SUCTION PROBES						
	DYONICS RF-S WHIRLWIND 90° Probe 72202139	DYONICS RF-S DYNAMO 90° Probe 72202138	DYONICS RF-S CROSS 50° Probe 72202140	DYONICS RF BROADNOSE 90° Probe 72202142	DYONICS RF ABLATION 90° Probe 72202141	DYONICS RF ROUND 60° Probe 72202148	DYONICS RF CURVE 45° Probe 72202143	DYONICS RF HEDGEHOG 45° Probe 72202144	DYONICS RF HOOK 30° Probe 72202145	DYONICS RF SLICE 20° Probe 72202146	DYONICS RF CONTRACT 30° Probe 72202147
<b>Shoulder</b>											
Subacromial decompression	•	•		•	•						
Frozen shoulder								•	•		
Synovectomy	•	•		•	•						
Ligament removal	•	•		•	•						
Ligament/ tendon coagulation											•
<b>Knee</b>											
Meniscectomy	•		•	•	•	•	•	•			
ACL/PCL debridement	•	•		•	•						
Lateral release								•	•		
Ligament removal	•	•		•	•						
Capsular/ligament/ tendon coagulation											•

# DYONICS<sup>◇</sup> RF Arthroscopy System

## DYONICS RF System Bipolar Probes

### Suction Probes

These powerful RF suction probes are equipped with a grated suction design that helps trap large debris before potentially causing a blockage.



Reference #	Description
72202139	DYONICS RF-S WHIRLWIND 90° Probe, 3.75 mm shaft diameter, 5.5 mm minimum cannula size



72202138	DYONICS RF-S DYNAMO 90° Probe, 3.5 mm shaft diameter, 5.5 mm minimum cannula size
----------	---



72202140	DYONICS RF-S CROSS 50° Probe, 3.0 mm shaft diameter, 5.5 mm minimum cannula size
----------	--

### Non-suction Probes



Reference #	Description
72202142	DYONICS RF BROADNOSE 90° Probe, 4.5 mm shaft diameter, 5.5 mm minimum cannula size



72202141	DYONICS RF ABLATION 90° Probe, 3.5 mm shaft diameter, 6.5 mm minimum cannula size
----------	---



72202148	DYONICS RF ROUND 60° Probe, 2.5 mm shaft diameter, 6.5 mm minimum cannula size
----------	--



72202143	DYONICS RF CURVE 45° Probe, 3.0 mm shaft diameter, 4.5 mm minimum cannula size
----------	--



72202144	DYONICS RF HEDGEHOG 45° Probe, 2.5 mm shaft diameter, 4.5 mm minimum cannula size
----------	---



72202145	DYONICS RF HOOK 30° Probe, 3.0 mm shaft diameter, 8.5 mm minimum cannula size
----------	---



72202146	DYONICS RF SLICE 20° Probe, 3.3 mm shaft diameter, 5.5 mm minimum cannula size
----------	--



72202147	DYONICS RF CONTRACT 30° Probe, 3.0 mm shaft diameter, 5.5 mm minimum cannula size
----------	---

# DYONICS<sup>®</sup> RF Arthroscopy System

## DYONICS RF System Probe Indications – Canada Only Part Numbers

High-performance DYONICS RF probes are designed to deliver rapid resection and precision sculpting of soft tissue. Large surface areas ensure quick tissue removal and cutting, while the patented bipolar technology delivers precisely focused energy to the targeted tissue. Probes are available in a variety of angle and electrode configurations, ideal for shoulder and knee procedures.

	SUCTION PROBES				NON-SUCTION PROBES						
	DYONICS RF-S WHIRLWIND 90° Probe 72203178	DYONICS RF-S DYNAMO 90° Probe 72203177	DYONICS RF-S CROSS 50° Probe 72203179	DYONICS RF BROADNOSE 90° Probe 72203181	DYONICS RF ABLATION 90° Probe 72203180	DYONICS RF ROUND 60° Probe 72203187	DYONICS RF CURVE 45° Probe 72203182	DYONICS RF HEDGEHOG 45° Probe 72203183	DYONICS RF HOOK 30° Probe 72203184	DYONICS RF SLICE 20° Probe 72203185	DYONICS RF CONTRACT 30° Probe 72203186
<b>Shoulder</b>											
Subacromial decompression	•	•		•	•						
Frozen shoulder								•	•		
Synovectomy	•	•		•	•						
Ligament removal	•	•		•	•						
Ligament/ tendon coagulation											•
<b>Knee</b>											
Meniscectomy	•		•	•	•	•	•	•			
ACL/PCL debridement	•	•		•	•						
Lateral release								•	•		
Ligament removal	•	•		•	•						
Capsular/ligament/ tendon coagulation											•



# DYONICS<sup>◇</sup> RF Arthroscopy System

## DYONICS RF System Bipolar Probes – Canada Only Part Numbers



Reference #	Description
72203189	DYONICS RF System <i>System includes DYONICS RF generator, foot pedal and power cord</i>
<b>Accessories</b>	
72203190	Foot Pedal
72203191	Accessory Kit (includes IFU and US power cord)

### Suction Probes

These powerful RF suction probes are equipped with a grated suction design that helps trap large debris before potentially causing a blockage.



Reference #	Description
72203178	DYONICS RF-S WHIRLWIND 90° Probe, 3.75 mm shaft diameter, 5.5 mm minimum cannula size



72203177	DYONICS RF-S DYNAMO 90° Probe, 3.5 mm shaft diameter, 5.5 mm minimum cannula size
----------	---



72203179	DYONICS RF-S CROSS 50° Probe, 3.0 mm shaft diameter, 5.5 mm minimum cannula size
----------	--

### Non-suction Probes



Reference #	Description
72203181	DYONICS RF BROADNOSE 90° Probe, 4.5 mm shaft diameter, 5.5 mm minimum cannula size



72203180	DYONICS RF ABLATION 90° Probe, 3.5 mm shaft diameter, 6.5 mm minimum cannula size
----------	---



72203187	DYONICS RF ROUND 60° Probe, 2.5 mm shaft diameter, 6.5 mm minimum cannula size
----------	--



72203182	DYONICS RF CURVE 45° Probe, 3.0 mm shaft diameter, 4.5 mm minimum cannula size
----------	--



72203183	DYONICS RF HEDGEHOG 45° Probe, 2.5 mm shaft diameter, 4.5 mm minimum cannula size
----------	---



72203184	DYONICS RF HOOK 30° Probe, 3.0 mm shaft diameter, 8.5 mm minimum cannula size
----------	---



72203185	DYONICS RF SLICE 20° Probe, 3.3 mm shaft diameter, 5.5 mm minimum cannula size
----------	--



72203186	DYONICS RF CONTRACT 30° Probe, 3.0 mm shaft diameter, 5.5 mm minimum cannula size
----------	---

# VULCAN<sup>®</sup> RF Arthroscopy System

## VULCAN RF Arthroscopy System



The Smith & Nephew VULCAN Arthroscopy System is designed to help improve procedure efficiency and outcome with a complete line of RF products for knee, shoulder, hip and extremity procedures.

### Flexible

Monopolar, bipolar, temperature control and impedance monitoring capabilities aid in optimizing energy delivery to produce the desired tissue effect.

### Simple

All Smith & Nephew RF probes are available with integrated cables which increases staff efficiency by eliminating cable sterilization and storage requirements.

### Convenient

Autoprobe recognition takes the guesswork out of selecting power settings. Troubleshooting is facilitated with audible alarms and error message displays.

### VULCAN RF Arthroscopy System

Systems include VULCAN generator, power cord, footswitch and manual

Reference #	Description
7210868	VULCAN Generator System, US
7210869	VULCAN Generator System, Europe
7210870	VULCAN Generator System, UK
7210898	VULCAN Generator System, Australia
7210897	VULCAN Generator System, India
7210871	VULCAN Generator System, South Africa
7210872	VULCAN Generator System, Italy
<b>Accessories</b>	
7210812	VULCAN Generator only
7209693	VULCAN Extension Cables (for use only with original version of EFLEX <sup>®</sup> Probes)
7209692	VULCAN Footswitch
7209687	Split Electrode Pads, 1 each
7209597	Probe Tip Bender
72201356	3.71 Software

# VULCAN<sup>®</sup> RF Arthroscopy System

## VULCAN RF System Probe Indications

The Smith & Nephew VULCAN Arthroscopy System includes the most versatile line of RF probes in the industry. Please refer to the following pages for more detail on each of these products.

	<b>SAPHYRE<sup>®</sup>, ABLATOR<sup>®</sup>, SCULPTOR<sup>®</sup>**</b>	<b>DYONICS<sup>®</sup> GLIDER</b>	<b>TAC<sup>®</sup>**</b>	<b>LIGAMENT CHISEL<sup>®</sup>**</b>	<b>DYONICS ELECTROBLADE<sup>®</sup> Resector</b>
<b>Shoulder</b>					
Subacromial decompression	•				•
Capsular release				•	
Capsulorrhaphy			•		
Synovectomy	•				
CA Ligament removal	•				
<b>Knee</b>					
Meniscectomy	•				
ACL/PCL debridement	•				•
Chondroplasty		•	•		
Medial plication			•		
Lateral release				•	
<b>Hip</b>					
Acetabular labrum resection	•			•	
Synovectomy	•			•	
Loose body excision				•	
Tendon resection and release	•			•	
Thermal capsulorrhaphy			•		
Tissue smoothing	•	•	•		
Ligamentum teres treatment			•		
Capsular resection	•			•	
Chondroplasty		•	•		
<b>Wrist/Elbow/Ankle</b>					
TFCC debridement	•			•	
Scar tissue excision	•				
Chondroplasty			•		
Capsulorrhaphy			•		

NOTE: For use with the VULCAN RF System  
\* Includes EFLEX<sup>®</sup> models

Call +1 800 343 5717 (U.S.) or contact your local representative.

## VULCAN<sup>®</sup> RF Arthroscopy System

### SAPHYRE<sup>®</sup> Bipolar Ablation Probes



#### SAPHYRE Ablation Probes

SAPHYRE Ablation Probes deliver powerful, consistent RF energy for vigorous soft tissue ablation and hemostasis. The jewel-cut electrodes deliver focused energy to target tissue with reduced current output requirements, generating less heat than competitive ablation probes. In addition, the SAPHYRE Bipolar Ablation Probe Coolback Shaft reduces the risk of secondary tissue heating at the return electrode site.

Reference #	Description	Shaft Color
7209686	SAPHYRE Ablation Probe, 90°	Pewter
7209685	SAPHYRE Ablation Probe, 60°	Pewter
7209684	SAPHYRE Ablation Probe, 90° high profile	Pewter



#### SAPHYRE II Ablation Probes

The SAPHYRE II Bipolar Ablation Probes have integrated suction for enhanced visualization in the sterile field.

Reference #	Description	Shaft Color
7210111	SAPHYRE II Ablation Probe with suction, 90°	Pewter
7210113	SAPHYRE II Ablation Probe with suction, 60°	Pewter
7210112	SAPHYRE II Ablation Probe with suction, 90° high profile	Pewter
7210491	SAPHYRE II Ablation Probe with suction, 40°	Pewter

## VULCAN<sup>®</sup> RF Arthroscopy System

### ABLATOR<sup>®</sup> and SCULPTOR<sup>®</sup> Monopolar Ablation Probes



#### ABLATOR Monopolar Ablation Probes

The ABLATOR monopolar probes provide a wide scope of probe styles for arthroscopic applications in the shoulder, knee and small joint. Features such as the power pocket electrode high-flow extractor lumen on suction probes help optimize tissue ablation, coagulation and visualization of the surgical site.

Reference #	Description	
7209659	ABLATOR Ablation Probe, 90°	Black
7209654	ABLATOR-S Ablation Probe, 90° with suction	Black
7209657	ABLATOR Ablation Probe, 60°	Black
7209653	ABLATOR-S Ablation Probe, 60° with suction	Black
7209655	ABLATOR Ablation Probe, 90° high profile	Black
7209651	ABLATOR-S Ablation Probe, 90° high profile with suction	Black
7209650	ABLATOR Ablation Probe, 60°, 2.0 mm	Black
7209652	ABLATOR-S Ablation Probe, 60°, 2.0 mm with suction	Black
7209658	ABLATOR Ablation Probe, 30°	Black
7209656	Micro ABLATOR Probe, 60°	Black
7209641	Micro ABLATOR-S Probe, 60° with suction	Black
72200683	EFLEX <sup>®</sup> ABLATOR Probe with integrated cable	Black

#### SCULPTOR Monopolar Ablation Probes

SCULPTOR Monopolar Probes combine the power of monopolar ablation with consistent, vigorous, predictable soft tissue removal and hemostasis.

Reference #	Description	
7210698	SCULPTOR Probe, 90°	Black
7210697	SCULPTOR-S Probe, 90° with suction	Black
7210700	SCULPTOR Probe, 90° high profile	Black
7210695	SCULPTOR-S Probe, 90° high profile with suction	Black
7210699	SCULPTOR Probe, 60°	Black
7210696	SCULPTOR-S Probe, 60° with suction	Black

## VULCAN<sup>®</sup> RF Arthroscopy System

### DYONICS<sup>®</sup> GLIDER<sup>®</sup> Monopolar Articular Cartilage Probe

Designed exclusively for treatment of chondromalacia, indicated specifically for chondroplasty. The DYONICS GLIDER monopolar probe debrides and smooths diseased cartilage along the contoured surfaces of the joint while limiting the depth of chondrocyte death to 150 microns or less.†

#### Articular Cartilage Probe

The GLIDER probe is an early-intervention tool for treatment of articular cartilage disease. Through controlled application of RF energy on Grade II and III chondromalacia, the GLIDER probe is designed to maximize preservation of healthy cartilage tissue while restoring a smooth gliding surface.

#### Creates a smooth cartilage surface

In vitro studies have demonstrated the DYONICS GLIDER probe creates a smooth cartilage surface with a superficial layer of cell death.

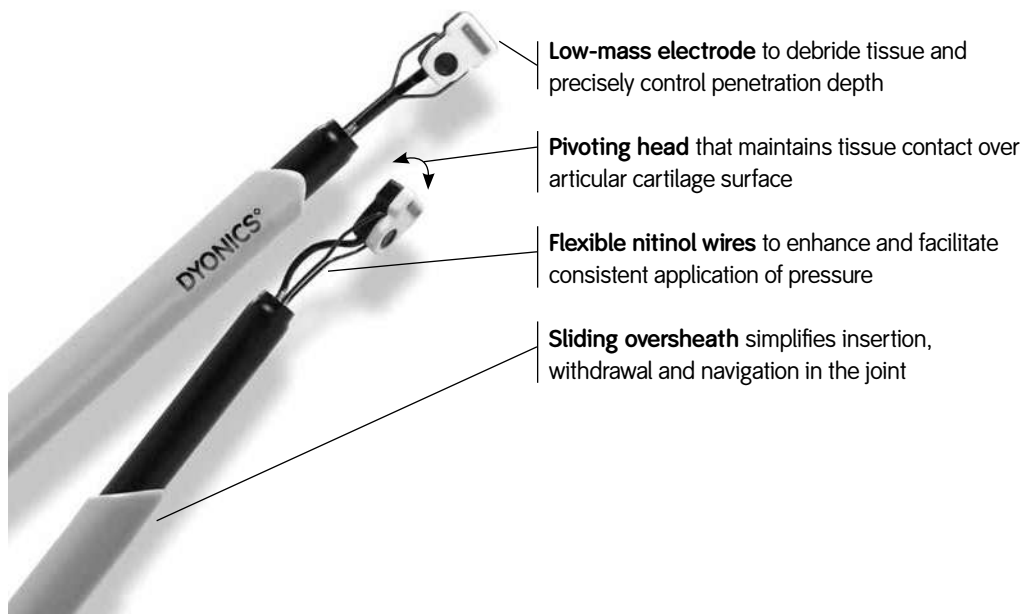

Reference #	Description	Shaft Color
7210438*	DYONICS GLIDER Articular Cartilage Probe (requires 3.71 software)	Black
<b>Optional</b>		
7210977	Reuseable slotted cannula	

\* Item shown

† Data on file at Smith & Nephew, 2008.

NOTE: For use with the VULCAN RF System

## VULCAN<sup>®</sup> RF Arthroscopy System

### Temperature Control Monopolar Probes

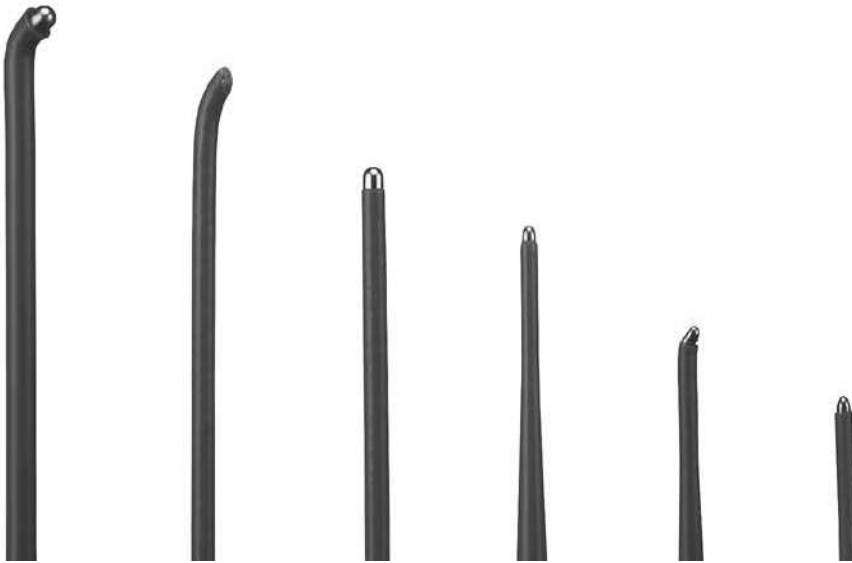

#### TAC Probes

The Smith & Nephew TAC monopolar probes are indicated for ligament shrinkage in the shoulder as well as coagulation of soft tissue in the knee, hip and small joints. Each TAC probe tip contains a sensor that relays tissue temperature back to the generator, enabling automatic selection and control of tissue temperature during treatment. All TAC probes incorporate a malleable shaft for added flexibility.

Reference #	Description	Shaft Color
7209630	TAC-S Probe, angled	Blue
7209628	TAC-C II Probe	Blue
7209633	TAC-S Probe	Blue
7209632	Mini TAC-S Probe	Blue
7209629	Micro TAC-S Probe, angled	Blue
7209631	Micro TAC-S Probe	Blue
72200681	EFLEX <sup>®</sup> TAC-S Probe with integrated cable	Blue

## VULCAN<sup>◇</sup> RF Arthroscopy System

### LIGAMENT CHISEL<sup>◇</sup> Monopolar Probes



#### LIGAMENT CHISEL Probes

The LIGAMENT CHISEL probes provide focused and precise resection, ablation and hemostasis of dense soft tissue in the shoulder, knee, hip and small joints. All probes incorporate a malleable shaft for added flexibility and access to difficult-to-reach areas.

Reference #	Description	Shaft Color
7209647	LIGAMENT CHISEL Probe, curved	Green
7209648	LIGAMENT CHISEL Probe, angled	Green
7209646	LIGAMENT CHISEL Probe, hook	Green
7209649	LIGAMENT CHISEL Probe, straight	Green
7209643	Micro LIGAMENT CHISEL Probe, hook	Green
7209645	Micro LIGAMENT CHISEL Probe, angled	Green
7209644	Micro LIGAMENT CHISEL Probe, curved	Green
7220682	EFLEX <sup>◇</sup> LIGAMENT CHISEL Probe with integrated cable	Green



## Single-use Blades

### DYONICS<sup>®</sup> ELECTROBLADE<sup>®</sup> Resector



DYONICS ELECTROBLADE Resectors simultaneously resect tissue and coagulate bleeding vessels, to help increase procedure efficiency and maintain visual clarity throughout the procedure. In addition, the bipolar design eliminates the need for a ground pad.

The BONECUTTER<sup>®</sup> ELECTROBLADE Resector is the first all-in-one device for subacromial decompression. A unique SURILLIUM<sup>®</sup> coating maintains blade durability and cutting efficiency throughout a procedure. Resector operates at speeds up to 8,000 RPM.

#### DYONICS ELECTROBLADE Resectors

Packaged 3 per box, sterile

Reference #	Description	Latch Color
72202213	4.5 mm DYONICS BONECUTTER ELECTROBLADE	Yellow
7205962	5.5 mm DYONICS BONECUTTER ELECTROBLADE Resector compatible with the VULCAN <sup>®</sup> Generator (requires the VULCAN Generator Adapter) and the Erbe Generator	Orange
7210380	VULCAN Generator Adapter (required to operate 7205962, packaged non-sterile, reusable)	
7205961	4.5 mm Full Radius, Valleylab Generator-compatible Compatible with the Valleylab*, Erbe† and VULCAN Generators (when used with the VULCAN Generator Adapter)	Yellow
7209855	4.5 mm Full Radius, VULCAN Generator-compatible	Yellow
7209700	4.5 mm ELITE, Full Radius, Valleylab Generator-compatible Compatible with the Valleylab*, Erbe† and VULCAN Generators (when used with the VULCAN Generator Adapter)	Maroon
7209983	4.5 mm ELITE, VULCAN Generator-compatible	Maroon

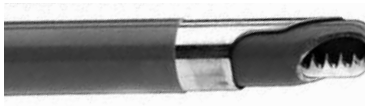
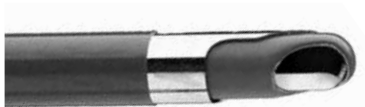





\* Valleylab Generator models are the Valleylab Force FX™ and Force™ 2

† Erbe Generators are the Erbe 300 and 350. Requires Erbe Adaptor #20183-022 – available through Erbe.

# Monopolar Hip Probes

## VULCAN<sup>®</sup> RF System Probe Hip Indications

	LIGAMENT CHISEL <sup>®</sup> Probe	ABLATOR <sup>®</sup> Probe	TAC-S Probe	LIGMENT CHISEL Probe	DYONICS GLIDER <sup>®</sup> Articular Cartilage Probe
<b>Hip</b>					
Acetabular labrum resection	•	•			
Synovectomy	•	•			
Loose body excision	•				
Tendon resection and release	•	•		•	
Thermal capsulorrhaphy			•		
Tissue smoothing		•	•		•
Ligamentum teres treatment			•		
Capsular resection	•	•		•	
Chondroplasty			•		•

Source: Schenker, ML & Phillipon MJ. The Role of Flexible Radiofrequency Energy Probes in Hip Arthroscopy Techniques in Orthopaedics 2005 20 (1):37-44

Information in this chart is intended as a suggestion only. Surgeons should use their medical judgement when selecting a probe for a patient's procedure.

### DYONICS EFLEX<sup>®</sup> Monopolar Radiofrequency Probes

DYONICS EFLEX probes can deflect up to 100°, enabling access into areas of the hip joint that are difficult to reach with conventional rigid probes. Tip deflection is actuated by an easy-to-pull trigger system, with an ergonomically designed handle and palm grip. EFLEX probes are also available with an integrated power cable, eliminating the need to purchase and re-sterilize separate cables.

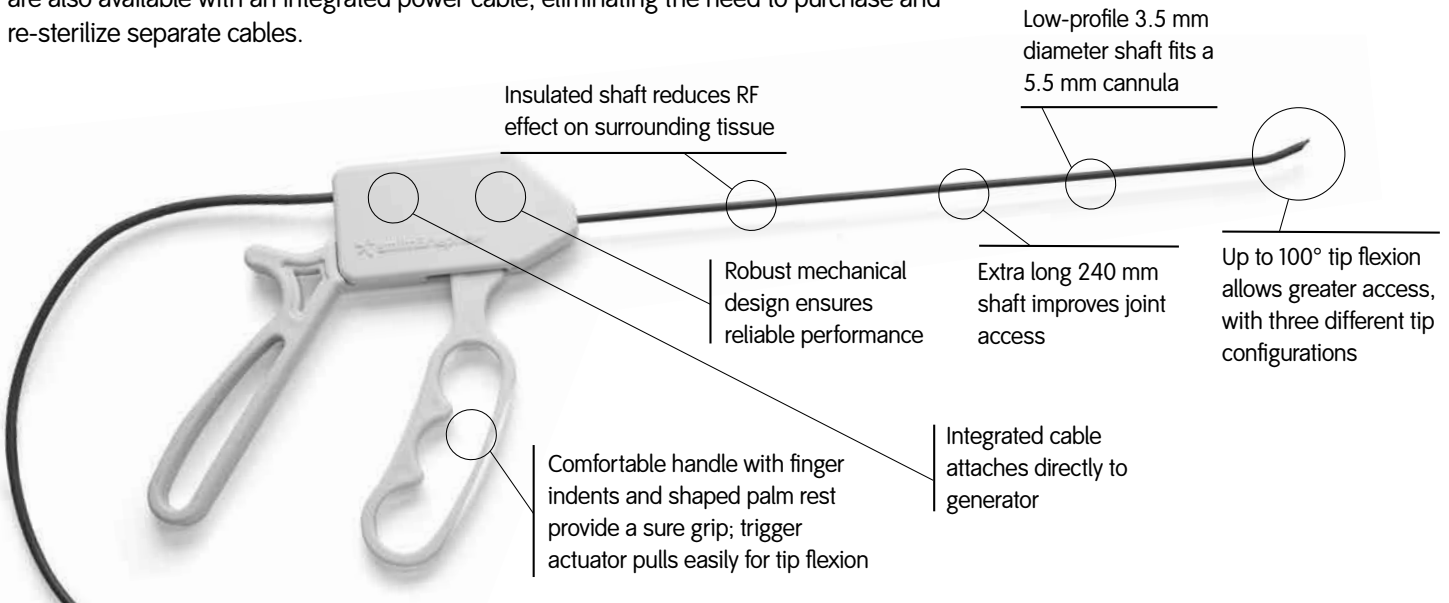

NOTE: For use with the VULCAN RF System

## Monopolar Hip Probes

### VULCAN® RF System Probes



#### DYONICS® EFLEX® Monopolar Radiofrequency Probes

Reference #	Description
72200682	DYONICS EFLEX LIGAMENT CHISEL® Probe with integrated cable
72200683	DYONICS EFLEX ABLATOR® Probe with integrated cable
72200681	DYONICS EFLEX TAC-S Probe with integrated cable



#### LIGAMENT CHISEL Monopolar Probe

Reference #	Description
7209646	LIGAMENT CHISEL Probe, hook



#### DYONICS GLIDER® Monopolar Articular Cartilage Probe

The DYONICS GLIDER probe is an early-intervention tool for treatment of articular cartilage disease. Through controlled application of RF energy on grade II and III chondromalacia, the GLIDER probe is designed to maximize preservation of healthy cartilage tissue while restoring a smooth gliding surface.

Reference #	Description
7210438	DYONICS GLIDER Articular Cartilage Probe

## VULCAN<sup>®</sup> RF Arthroscopy System

### Extremity Radiofrequency Probes



Smith & Nephew offers a versatile and comprehensive selection of radiofrequency probes for use in a variety of small joint arthroscopic procedures.





- All probes are bendable, increasing ability to access small spaces
- Micro ABLATOR<sup>®</sup>-S Probe offers the only small joint suction probe on the market
- Monopolar design ensures tissue treatment only occurs where the probe is applied

Reference #	Description	Shaft Color
7209656	Micro ABLATOR Probe, 60°	Black
7209641	Micro ABLATOR-S Probe, 60° with suction	Black
7209643	Micro LIGAMENT CHISEL <sup>®</sup> Probe, hook	Green
7209645	Micro LIGAMENT CHISEL Probe, angled	Green
7209644	Micro LIGAMENT CHISEL Probe, curved	Green
7209632	Mini TAC-S	Blue
7209629	Micro TAC-S, angled	Blue
7209631	Micro TAC-S, probe	Blue
7209687	Split Electrode Pads, 1 each	

## Arthroscopic Electrodes, Probes and Switchpens

### Arthroscopic Electrodes

Insulated for use in all fluids.

Reference #	Description
 7205441	Electrode, 90° L-hook tip, 170 mm working length, for use with REF 7205440 Switchpen or standard Valleylab™ Switchpen (10 per box)
 7205442	Electrode, 45° tip, 170 mm working length, for use with REF 7205440 Switchpen or standard Valleylab Switchpen (10 per box)
 7205443	Electrode, 90° flat tip, 170 mm working length, for use with REF 7205440 Switchpen or standard Valleylab Switchpen (10 per box)
 7205774	Electrode, 90° L-hook tip, short, 126 mm working length, for use with REF 7205440 Switchpen or standard Valleylab Switchpen (10 per box)

### Complete Probe and Pen Kit

Insulated for use in all fluids.

Reference #	Description
 7205565	Switchpen with L-hook electrode, for use in fluid media (5 per box)

### Switchpen

Insulated for use in all fluids.

Reference #	Description
 7205440	Switchpen, monopolar, leakproof, anti-rotating interface allows electrode positioning in eight fixed orientations, for use with REF 7205774, 7205443, 7205442 and 7205441 (5 per box)





Punches, Scissors, etc.

## ACUFEX® and ACUFEX Pro

Punches, Scissors, Graspers  
and Knives

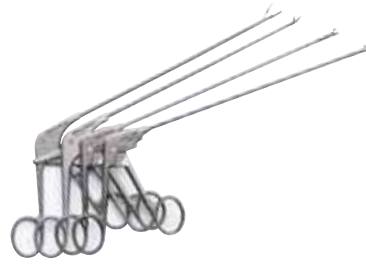

- Unrivaled strength, durability and sharpness
- Designed with a broad range of tips and configurations
- Preferred pinless hinge design

J



## ACUFEX<sup>®</sup> and ACUFEX Pro Handles and Tips

Smith & Nephew ACUFEX instruments are designed with a broad range of handles and tip configurations, allowing easy access to specific areas of the meniscus.

### ACUFEX Pro Handle

Selected punches, scissors and graspers feature this ergonomic handle design.



### Loop Handle

Scissors, basket punches and graspers feature our traditional loop-style handles.



### Cigar Handle

Available on rotary basket punches and scissors.



### ACUFEX Grasper Handle

All ACUFEX graspers feature this infinite-position, locking-handle design.

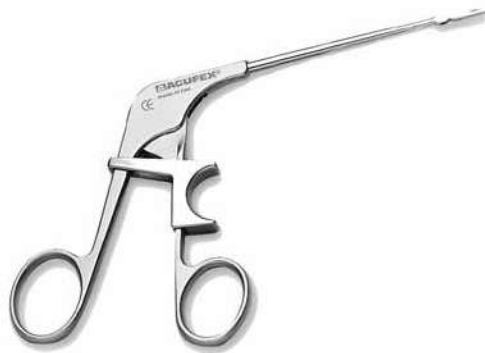

## Tip Selection Guide

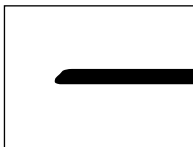

### Straight:

The primary style for direct approach

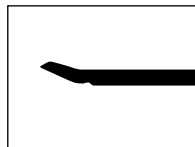

### Upbiter:

Angled 1/4" curve at tip for enhanced access to the posterior meniscus



### Upswept:

Angled shaft follows the contour of the condyle and keeps the cutting surface parallel to the tibial plateau

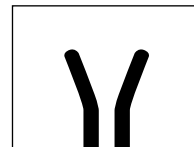

### Left and Right:

Angled to reach the anterior and posterior menisci

## ACUFEX<sup>®</sup> and ACUFEX Pro Punches

ACUFEX punches are offered in a broad range of tips and configurations. Each punch is constructed with our exclusive pinless hinge design, one-piece outer shaft and hand-honed edge to provide unrivaled strength, durability and sharpness.



### Narrowline Family

The small aggressive tip design and narrow shaft provides excellent maneuverability and multiple plane-cutting capability in the posterior horn of the meniscus in the tightest joint.



### DUCKBILL<sup>®</sup> Family

The wave-tooth design combined with a wide bite allows for the maximum amount of tissue to be smoothly resected in tight knees.



### DUCKLING<sup>®</sup> Family

Combining the wide-bite horizontal cutting capability of the DUCKBILL Punch with the thinnest possible tip provides optimum maneuverability under the condyle.



### Oval Punch Family

The lowest profile tip with the largest bite offers the most versatile instrument available. The curved saw design enables smooth contouring of the meniscus.



### Blunt Nose

The blunt nose and small size enables this instrument to get into the posterior horn for flush trimming of the meniscus.



### OVERBITER<sup>®</sup> Punch

Designed to resect the superior leaflet of the medial meniscus during an arthroscopic partial meniscectomy. Elevated lower tip prevents meniscus from resting against the tibia, while blunt nose allows instrument to lie squarely against the posterior horn area for flush trimming.



### Posterior Family

The gradually tapered shaft, low-profile tip and short-jaw design permit the tip to open wide for cutting in tight posterior compartments.



### STINGRAY<sup>®</sup> Punch

The back-biting capability of this punch offers the most direct access to the anterior meniscus. Available with a left- and right-sided bite.



### Meniscal Elevator

The meniscal elevator is designed to slide easily under a tight meniscus. The elevated tip prevents the meniscus from setting back down on the tibia, making successive bites easy.



### Scoop Family – 1.0 mm

The small size of this versatile punch, combined with the horizontal cutting capability, increases maneuverability where height is a limiting factor.



### Scoop Family – 1.3 mm

The seven unique shaft configurations of the 1.3 mm punches allow maneuverability in difficult-to-access areas of the meniscus.



### Scoop Family – 1.5 mm

The long jaw and wide design of the 1.5 mm family produce a wider, deeper cut than that of the 1.3 mm punch.



### 90° Rotary

This punch offers an effective angle for trimming the difficult-to-access anterior meniscus. The unique design of the tip allows for successive bites, ideal for balancing the meniscal rim.



### Straight Scissor Punch

The scissor punch, with its small bite size, allows for increased visibility and consistently provides a clean shear cut.



### Upbiter Scissor Punch

The upcurve tip of the upbiter scissor punch permits convenient shear cutting in the posterior aspect of the knee.

## ACUFEX<sup>◇</sup> and ACUFEX Pro Punches

### Basket Punches – Narrowline

The narrow shaft and compact jaw design facilitates access and use in tight spaces, particularly useful in the posterior aspect of the knee.



ACUFEX Pro Reference #	ACUFEX Reference #	Description	Tip Profile	Bite Width	Tip Width
7207053	012052*	Straight	1.9 mm	1.67 mm	2.89 mm
7207052	012051*	Upbiter	1.9 mm	1.67 mm	2.89 mm
7207658	012053	Upbiter, curved left	1.9 mm	1.67 mm	2.89 mm
7207660	012054	Upbiter, curved right	1.9 mm	1.67 mm	2.89 mm
7207659	012055*	Upswept	1.9 mm	1.67 mm	2.89 mm
7208679		45° tip, left	1.5 mm	1.67 mm	2.89 mm
7208685		45° tip, right	1.5 mm	1.67 mm	2.89 mm



#### Reference # Description

- ⚙ 7207552 Upswept, with larger finger and thumb loops
- ⚙ 7207733 Narrowline upbiter, length extended by 2.25"
- ⚙ 7207734 Narrowline upbiter, curved right, length extended by 2.25"

### Basket Punches – DUCKBILL<sup>◇</sup>

All-purpose, low-profile punches with a large square bite.



ACUFEX Pro Reference #	ACUFEX Reference #	Description	Tip Profile	Bite Width	Tip Width
7207057	012013*	Straight	2.52 mm	3.17 mm	5.05 mm
7207058	012014*	Upbiter	2.52 mm	3.17 mm	5.05 mm
7207667	012015	Upbiter, curved left	2.52 mm	3.17 mm	5.05 mm
7207664	012016	Upbiter, curved right	2.52 mm	3.17 mm	5.05 mm



## ACUFEX<sup>®</sup> and ACUFEX Pro Punches

### Oval Punches

This family of punches offers the best of both worlds — the lowest profile and the largest bite, facilitating end-on and lateral cutting — the most versatile instrument available.



ACUFEX Pro Reference #	ACUFEX Reference #	Description	Tip Profile	Bite Width	Tip Width
7207083	7207200	Upbiter	1.65 mm	4.39 mm	6.57 mm
7207181	7207201*	Straight	1.65 mm	4.39 mm	6.57 mm
N/A	7207294	Curved left	1.65 mm	4.39 mm	6.57 mm
N/A	7207295	Curved right	1.65 mm	4.39 mm	6.57 mm
N/A	7207296	Upswept	1.65 mm	4.39 mm	6.57 mm

### Reference # Description

⚙ 3134238	Curved left at 40 mm from tip
⚙ 7207533	Upbiter, with larger finger and thumb loops

### Basket Punches – Blunt Nose

ACUFEX Loop Handle. Blunt nose basket punch enables flush contouring of meniscus.



ACUFEX Pro Reference #	ACUFEX Reference #	Description	Tip Profile	Bite Width	Tip Width
N/A	012035	1.0 mm, straight	1.83 mm	1.67 mm	3.32 mm

### Basket Punches – DUCKLING<sup>®</sup>

The ACUFEX DUCKLING punches are a lower-profile relation to the DUCKBILL<sup>®</sup>, maintaining a large square bite and maximizing maneuverability.



ACUFEX Pro Reference #	ACUFEX Reference #	Description	Tip Profile	Bite Width	Tip Width
7207049	012044*	Straight	1.93 mm	3.17 mm	5.00 mm
7207050	012046	Curved left	1.93 mm	3.17 mm	5.00 mm
7207051	012047	Curved right	1.93 mm	3.17 mm	5.00 mm
7207668	014765	Elevator	1.93 mm	3.17 mm	5.00 mm
7207000	012045*	Upbiter	1.93 mm	3.17 mm	5.00 mm
7207672	012048*	Upswept	1.93 mm	3.17 mm	5.00 mm

### Reference # Description

⚙ 7205979	Upswept, low profile, extended 20 mm
⚙ 7207547	DUCKLING, 20° downbiter
⚙ 7207737	DUCKLING, upswept, length extended by 2.25"
7207736	DUCKLING, upbiter, extended length

\* Item shown

⚙ Special, Made to Order products are available to meet the individual needs of surgeons. Please appreciate that longer lead time for delivery should be expected. For more information, please contact your sales representative or Customer Service.

## ACUFEX<sup>◇</sup> and ACUFEX Pro Punches

### Posterior Punches

For the specific requirements of the posterior horn of the meniscus; the short, low-profile jaw facilitates working in the tight confines of the posterior aspect of the knee.



ACUFEX Pro Reference #	ACUFEX Reference #	Description	Tip Profile	Bite Width	Tip Width
7207662	012201*	upbiter	2.46 mm	2.18 mm	4.00 mm
7207666	012202	upswept	2.46 mm	2.18 mm	4.00 mm
7207665	012203	straight	2.46 mm	2.18 mm	4.00 mm
7207661	012204	curved left	2.46 mm	2.18 mm	4.00 mm
7207663	012205	curved right	2.46 mm	2.18 mm	4.00 mm

### Basket Punches – STINGRAY<sup>◇</sup>

These backbiters enable simple access to the anterior horn of the meniscus.



ACUFEX Pro Reference #	ACUFEX Reference #	Description	Tip Profile	Bite Width	Tip Width
7207055	012059	left	3.93 mm	2.38 mm	5.58 mm
7207054	012058*	right	3.93 mm	2.38 mm	5.58 mm
Reference #	Description				
7210730	STINGRAY Basket Punch, right, length extended by 2.25"				
7210731	STINGRAY Basket Punch, left, length extended by 2.25"				

### Basket Punches – Scoop

The most traditional style of instrument, a classical punch shape with the parrot beak upper jaw to help capture tissue.



ACUFEX Pro Reference #	ACUFEX Reference #	Description	Tip Profile	Bite Width	Tip Width
72200719	012029*	1.0 mm, straight	2.28 mm	1.59 mm	3.25 mm
⚙️ 7207657	012040	1.3 mm, curved left	2.10 mm	1.59 mm	3.27 mm
⚙️ 7207656	012041	1.3 mm, curved right	2.10 mm	1.59 mm	3.27 mm
72200716	012030	1.3 mm, upbiter	2.10 mm	1.59 mm	3.27 mm
N/A	012042	1.3 mm, upbiter, curved left	2.10 mm	1.59 mm	3.27 mm
N/A	012043	1.3 mm, upbiter, curved right	2.10 mm	1.59 mm	3.27 mm
N/A	012031*	1.3 mm, upswept	2.10 mm	1.59 mm	3.27 mm
N/A	012033	1.3 mm, downbiter	2.10 mm	1.59 mm	3.27 mm
7207046	012034	1.5 mm, straight	2.28 mm	1.59 mm	3.88 mm

### Basket Punches – Scoop, extended length for hip procedures



Reference #	Description
7207735	1.5 mm, upbiter, extended length

\* Item shown

# ACUFEX<sup>®</sup> and ACUFEX Pro Punches



ACUFEX Pro Reference #	ACUFEX Reference #	Description	Tip Profile	Bite Width	Tip Width
6901029	012020*	1.5 mm, upbiter	2.28 mm	1.59 mm	3.88 mm
N/A	012032	1.5 mm, upswept	2.28 mm	1.59 mm	3.88 mm
N/A	012011	2.7 mm, straight	2.28 mm	1.77 mm	3.58 mm
N/A	012012	3.4 mm, straight	2.94 mm	2.03 mm	3.76 mm

NOTE: The dimensions given refer to the height of the lower jaw at the distal end.

Reference #	Description
⚙️ 72202005	1.7 mm, straight, ACUFEX Pro Handle

### Basket Punches – Meniscal Elevator

The extended lip of the lower jaw assists in placing the lower jaw underneath less-mobile menisci.

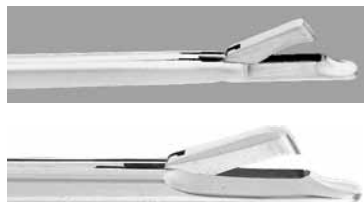

ACUFEX Pro Reference #	ACUFEX Reference #	Description
N/A	012060	1.3 mm, straight
7207671*	012061	1.3 mm, upbiter

### Basket Punches – 90° Rotary

90° Rotary 2.2 mm – tip profile 3.36 mm, bite width 3.17 mm, tip width 6.79 mm

90° Rotary 3.4 mm – tip profile 3.86 mm, bite width 3.17 mm, tip width 6.79 mm



Loop Handle Reference #	Cigar Handle Reference #	Description
010912	010906	2.2 mm, left
010913*	010907	2.2 mm, right
N/A	010900	3.4 mm, left
N/A	010901	3.4 mm, right

### Basket Punches – 90° Rotary, extended length for hip procedures



Reference #	Description
7207545*	2.2 mm left, extended length
7207544*	2.2 mm, right, extended length

\* Item shown

⚙️ Special, Made to Order products are available to meet the individual needs of surgeons. Please appreciate that longer lead time for delivery should be expected. For more information, please contact your sales representative or Customer Service.

## Suction Punches

### Punches and Accessories

#### DYOVAC® Suction Punches

Offers the dual convenience of resecting tissue while simultaneously evacuating through a suction channel in the instrument.

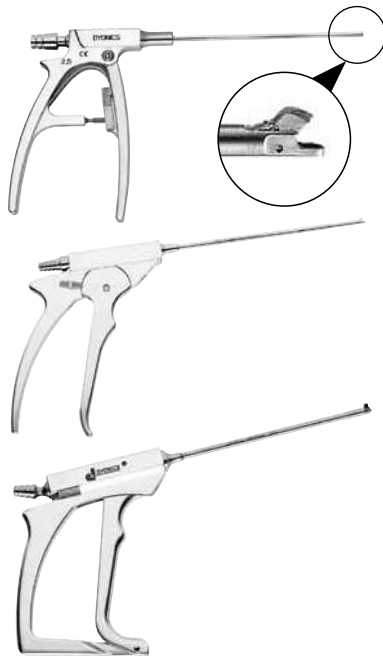

Reference #	Description
3499	2.5 mm, straight
2685	5.2 mm, straight
2707*	3.4 mm, straight
3196*	4.5 mm, 90° left
3197	4.5 mm, 90° right

## Accessories



#### Blade Retention Screws

12 per box

Reference #	Description
2714*	For 3.4 mm suction punch
2699	For 5.2 mm suction punch

#### Replacement Blades

Reference #	Description
3585	For 3.4 mm suction punch, 1 each
3586	For 5.2 mm suction punch, 1 each

#### Cleaning Brushes

10 per box

Reference #	Description
2715	For 3.4 mm suction punch
2697	For 5.2 mm suction punch
3349	For 4.5 mm suction punch
3577	For 2.5 mm suction punch

## ACUFEX<sup>®</sup> and ACUFEX Pro Scissors

Smith & Nephew ACUFEX scissors are constructed without pins for maximum strength, dependability, durability and safety.

A wide range of tips and angles enable the surgeon to effectively dissect any part of the meniscus from virtually any direction.



### Rotary Scissors

Loop Handle Reference #	Cigar Handle Reference #	Description
010814*	010800	20° hooked, left
010815	010801	20° hooked, right
010812*	010802	60° hooked, left
010813	010803	60° hooked, right
010816*	N/A	20° short, serrated, left
010817	N/A	20° short, serrated, right
N/A	010806	20° serrated, left
N/A	010807	20° serrated, right



### Scissors Punches

ACUFEX Pro Reference #	ACUFEX Reference #	Description
7207047	012036	Straight
7207048	012037	Upbiter
7207669	012038*	Upbiter, curved left
7207670	012039	Upbiter, curved right



### Meniscal OVERBITER<sup>®</sup> Punch

Used where access is required into superior meniscal flap region.

ACUFEX Pro Reference #	ACUFEX Reference #	Description
N/A	7209878	Overbiter



\* Item shown

⚙️ Special, Made to Order products are available to meet the individual needs of surgeons. Please appreciate that longer lead time for delivery should be expected. For more information, please contact your sales representative or Customer Service.



## ACUFEX<sup>◇</sup> and ACUFEX Pro Graspers

A broad selection of procedure-specific tip configurations provide maximum grasping capability and allow easy access to all areas of the meniscus from a variety of approaches.

ACUFEX Grasper Handled Graspers feature an “infinite position” sliding-lock mechanism that holds tissue firmly without tearing or slipping — even in the tightest areas.

Locking mechanism is not available on ACUFEX Pro.

### Graspers – Loosebody Forceps



ACUFEX Pro Reference #	ACUFEX Reference #	Description
7207061*	011022	PITBULL <sup>◊</sup>
72202517		Large PITBULL Grasper
7207731*	N/A	PITBULL Grasper, extended length

### Graspers – Cupped



ACUFEX Pro Reference #	ACUFEX Reference #	Description
N/A	011012	2.7 mm
7207059*	011014	3.4 mm
N/A	7207700	3.4 mm, length extended by 2.25"

Reference #	Description
⚙️ 7207673	2.7 mm upcurved grasper, Alligator, ACUFEX Pro Handle
⚙️ 3134239	Grasper, cupped, 3.4 mm, no teeth
⚙️ 6900595Z	Grasper, Johnson Jaw, 130 mm long
⚙️ 7205983	Grasper, Johnson Jaw Jr., 130 mm long

### Rongeur



Loop Handle Reference #	Description
014720*	RAPTOR <sup>◊</sup>
014843	RAPTOR Jr.
7207732	RAPTOR Rongeur, length extended by 2.25"

Reference #	Description
⚙️ 7207553	RAPTOR Rongeur with larger finger and thumb loops
⚙️ 7210757	RAPTOR Jr., down swept 10°



## ACUFEX<sup>®</sup> and ACUFEX Pro Graspers

ACUFEX Grasper Handled Graspers feature an “infinite position” sliding-lock mechanism that holds tissue firmly without tearing or slipping — even in the tightest areas. Locking mechanism is not available on ACUFEX Pro.

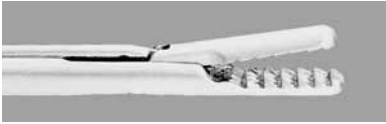
### Graspers – Alligator

	ACUFEX Pro Reference #	ACUFEX Reference #	Description	Tip Profile	Tip Width
	7207060*	011020	2.7 mm, straight	2.66 mm	3.05 mm
	7207673	011021	2.7 mm, upcurved	2.66 mm	3.05 mm
	N/A	011024*	Alligator Max	3.17 mm	3.45 mm
	N/A	7207699	Alligator Max, length extended by 2.25"	3.17 mm	3.45 mm

### Graspers – Atraumatic

	ACUFEX Pro Reference #	ACUFEX Reference #	Description
	N/A	011030*	Tissue Tensor, straight
	N/A	014779*	Cannulated Tissue Tensor, straight

\* Item shown

⚙️ Special, Made to Order products are available to meet the individual needs of surgeons. Please appreciate that longer lead time for delivery should be expected. For more information, please contact your sales representative or Customer Service.

## Extremity Instruments

### Extremity Arthroplasty Instruments

Shorter shafts and lower profile tips meet the specific demands of the small-joint surgeon. Available individually or in a convenient system with a dedicated tray.

NOTE: 81.7 mm working length

#### Punches



Reference #	Description
014843	RAPTOR® Jr. punch

014844	Blunt Nose Jr. punch
--------	----------------------

#### Micro Instrument Punches (overall reduced tip size)

Reference #	Description
7207600	MicroPunch, straight
7210754	MicroPunch, down swept 10°
⚙ 7210754	MicroPunch, straight, down swept 10°
7207601	Teardrop punch, right
7210755	Teardrop punch, right, down swept 10°
7207602	Teardrop punch, left
7210756	Teardrop punch, left, down swept 10°
⚙ 7210755	Teardrop punch, right, down swept 10°
⚙ 7210756	Teardrop punch, left, down swept 10°

#### Graspers



Reference #	Description
014845	PITBULL® Jr. grasper

013219	Small joint graspers
--------	----------------------

#### Micro Instrument Graspers (overall reduced tip size)

Reference #	Description
7207598	MicroGrasper, straight
7210753	MicroGrasper, down swept 10°
7207599	MicroGrasper, up 10°
⚙ 72203613	MicroGrasper, straight with ratchet
⚙ 7210753	MicroGrasper, straight, down swept 10°

## Extremity Instruments

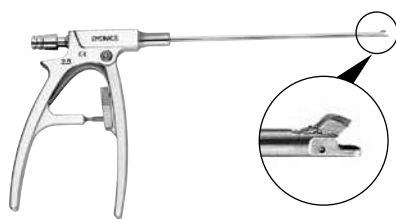

### DYOVAC<sup>®</sup> Suction Punches

Reference #	Description
-------------	-------------

3499	2.5 mm Suction Punch
------	----------------------

Note: Suction Punch accessories can be found on page J-7.

### Probes

Reference #	Description
-------------	-------------



3856	Probe, 3 mm
------	-------------



3312	Hook Probe, 0.39"/1 mm
------	------------------------



7209134	ELITE <sup>®</sup> Calibrated Probe, length: 8.5", tip height: 0.125", 0.165"/4.2 mm
---------	--

7207760	Probe, 3 mm extended length: 11.6"
---------	------------------------------------

- ⚙ 3134236 Small Joint Probe
- ⚙ 3134237 Small Joint Elevator

### Curettes

Reference #	Description
-------------	-------------

- ⚙ 3134240 Curette, closed 3.0 mm, extended 4.0 cm shaft
- ⚙ 3134266 Curette, NOTCHMASTER<sup>®</sup>, 6.0 mm









### Chondral Picks

Reference #	Description
-------------	-------------



- ⚙ 6900833 Chondral Pick, 3.5 mm, 45° bend
- ⚙ 6900834 Chondral Tamp, 3.5 mm, 45° tip

## ACUFEX<sup>◇</sup> Knives

### ACUFEX Knives

Reference #	Description
 010600	Hook - 3.0 mm straight, disposable <sup>†</sup> (5 per box)
010161*	Hook - 5.0 mm straight, reusable
 010610*	Rosette - 3.0 mm straight, disposable <sup>†</sup> (5 per box)
 010630	Banana - 3.0 mm, serrated, straight, disposable <sup>†</sup> (5 per box)
010121*	Banana - 5.0 mm, serrated, straight, reusable <i>(NOTE: use 5.5 mm cannula)</i>
 010620*	Meniscectomy - 3.0 mm, round tip, straight, disposable <sup>†</sup> (5 per box)
 010640*	Meniscectomy - 3.0 mm, serrated flat, straight, disposable <sup>†</sup> (5 per box)
 010650*	Meniscectomy - 3.0 mm, sharp tip, straight, disposable <sup>†</sup> (5 per box)
 010660*	Meniscectomy - 3.0 mm, V-shaped, straight, disposable <sup>†</sup> (5 per box)
 010680*	Reusable handle for disposable knife
⚙ 3134216	3.0 mm, straight, sharp tip
⚙ 3134217	5.0 mm, straight, sharp tip

### Arthroscopic Hip Set Instrumentation - Knives

Reference #	Description
72203307*	BEAVER <sup>®</sup> 4.0 mm Banana Blade, sterile, disposable (6 per box)
72203308*	BEAVER <sup>®</sup> Handle and Wrench, reusable
7210758	Banana Blade Knife, reusable
72202487	Banana Blade Knife, cannulated, reusable
	
	

### Magnetic Retrievers

Reference #	Description
⚙ 011501	3.0 mm, curved, 30°
⚙ 011502	4.0 mm, straight

\* Item shown

† Disposable knives are supplied as a box of 5, single-use, sterile packs.

BEAVER<sup>®</sup> is a registered trademark of BVI.

Call +1 800 343 5717 (U.S.) or contact your local representative.

# Probes

Probes

Reference # Description

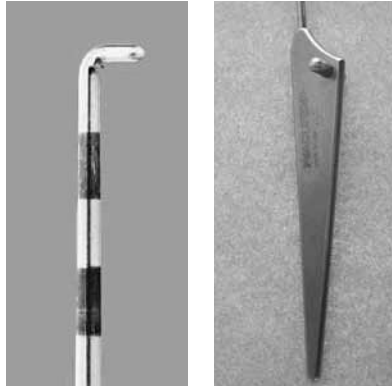

010001\* Straight



010525 Cannular, 3.0 mm, straight



010002\* Curved, left 30°  
010003 Curved, right 30°



Reference # Description  
7204869 3.0 mm, heavy hook (with handle)

\* Item shown

# Instrument Sterilization Tray



Sterilization Tray

Reference #	Description
011673	Linear Instruments Fifteen-unit Sterilization Tray

# Recommended Handheld Instrument

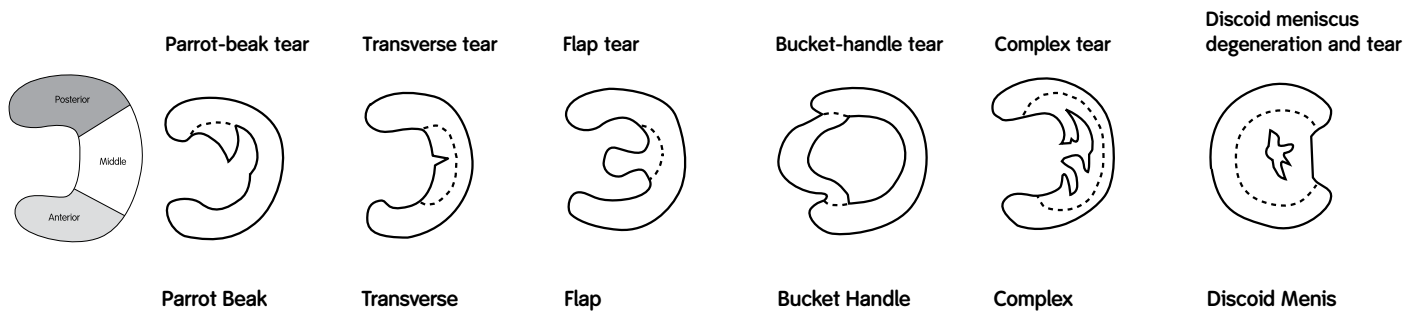

	Parrot Beak	Transverse	Flap	Bucket Handle	Complex	Discoid Menis
<b>Posterior</b>	All Narrowline All DUCKLING® All Scissor Punches Oval Punches	All Narrowline All DUCKLING All Scissor Punches Oval Punches	All Narrowline All DUCKLING All Scissor Punches 1.5 mm Upbiter Oval Punches	All Narrowline All DUCKLING All Scissor Punches 60° Hooked Scissors	All Narrowline All DUCKLING All Scissor Punches Oval Punches	All Narrowline All DUCKLING All Scissor Punches Oval Punches
<b>Middle</b>	All DUCKLING All 1.5 mm All 1.3 mm 1.0 mm Scoop 2.7 mm Punches 3.4 mm Punches Oval Punches	All DUCKLING All 1.5 mm All 1.3 mm 1.0 mm Scoop All Scissor Punches Oval Punches Meniscal Elevator	All DUCKLING All 1.5 mm All 1.3 mm 1.0 mm Scoop DUCKLING Curved Scissor Punch Curved Meniscal Elevator Oval Punches	All DUCKLING Oval Punches	All DUCKLING All 1.5 mm All 1.3 mm 2.7 mm Punches Oval Punches	All DUCKLING 60° Hooked Scissors Oval Punches
<b>Anterior</b>	90° Punches 60° Hooked Scissors Left Swept Right Swept STINGRAY® Punches Oval Punches	90° Punches 60° Hooked Scissors Left Swept Right Swept STINGRAY Punches Oval Punches	90° Punches 60° Hooked Scissors Left Swept Right Swept 20° Serrated STINGRAY Punches Oval Punches	90° Punches 60° Hooked Scissors Left Swept Right Swept Oval Punches	90° Punches 60° Hooked Scissors Left Swept Right Swept STINGRAY Punches Oval Punches	90° Punches 60° Hooked Scissors Left Swept Right Swept STINGRAY Punches Oval Punches

Graspers	Applications
PITBULL®	Loose Body      Bucket Handle      ACL Bone Block Assist
2.7 Cupped	Tight Compartment      Bucket Handle      Flap      Small, Loose Body
3.4 Cupped	Bucket Handle      Loose Body
Alligator	Tight Compartment
Alligator Max	Tight Compartment      Bucket Handle
RAPTOR® Rongeur	Biopsy



## Recommended Handheld Instrument Starter Kits

### Comprehensive Set

#### SIMPLE SEVEN

Looking for the most utility with the least amount of investment; we suggest this high performance seven-piece set.

ACUFEX® Pro Handle REF	ACUFEX Loop Handle REF	Description
7207057	012013	DUCKBILL® Basket Punch, straight
7207050	012046	DUCKLING® Basket Punch, curved left
7207051	012047	DUCKLING Basket Punch, curved right
7207672	012048	DUCKLING Basket Punch, upswept
7207058	012014	DUCKBILL Basket Punch, upbiter
7207052	012051	Narrowline Basket Punch, upbiter
	011024	2.7 mm Alligator Max Grasper

#### FLEXIBLE FIFTEEN

Need a more comprehensive instrument set for increased functionality; we suggest this fifteen-piece set.



ACUFEX Pro Handle REF	ACUFEX Loop Handle REF	Description
N/A	010912	90° Rotary Basket Punch, 2.2 mm left
N/A	010913	90° Rotary Basket Punch, 2.2 mm right
7207055	012059	STINGRAY® Basket Punch, left
7207054	012058	STINGRAY Basket Punch, right
7207057	012013	DUCKBILL Basket Punch, straight
7207050	012046	DUCKLING Basket Punch, curved left
7207051	012047	DUCKLING Basket Punch, curved right
7207672	012048	DUCKLING Basket Punch, upswept
	012012	Scoop Basket Punch, 3.4 mm, straight
7207058	012014	DUCKBILL Basket Punch, upbiter
7207047	012036	Scissors Punch, straight
7207052	012051	Narrowline Basket Punch, upbiter
7207662	012201	Posterior, upbiter
	011024	2.7 mm Alligator Max Grasper
7207061	011022	PITBULL® Loose-body Forceps

## Care and Maintenance

### Cleaning, Lubrication and Resharpener/Preventive Maintenance

The shafts and tips of ACUFEX® Instruments are of specially formulated and treated surgical stainless steel for optimum sharpness and resistance to corrosion. However, correct care and maintenance are important in optimizing the performance of your instruments. Please use the information here to protect your investment.

#### **Cleaning**

Whenever possible, use demineralized, distilled water, when cleaning your instruments. Mineral deposits and impurities in tap water can lead to corrosion. For washing, use a detergent or solution pH (7.0 to 11.0) for safe cleaning. Ultrasonic cleaners may be used to clean your instruments. After cleaning, dry the instruments to prevent water impurities from collecting on surfaces. Replace the instruments in the ACUFEX Sterilization Trays between uses to protect the instrument tips.

#### **Lubrication**

To protect instruments from staining and rusting prior to sterilization or storage, dip instruments into a water-soluble antimicrobial lubricant, following manufacturer's instructions. The lubricant will help to free stiff instruments; if dipping does not free an instrument, try soaking it overnight.

#### **Resharpener/Preventative Maintenance**

Instruments need to be inspected and evaluated on a regular basis to determine whether resharpener, realignment or refurbishment is needed. Routine service will aid in promoting proper function and performance. Only sharpening by Smith & Nephew can maintain and restore the sharpness of the cutting blade or tip to our original manufacturing specifications. Regular maintenance and the use of a Smith & Nephew facility for resharpener will increase the life of the instruments.

---

### **CLEAR-TRAC<sup>®</sup> COMPLETE**

Disposable Cannula System



- Threaded design permits easy insertion and provides excellent retention
- Integrated triple-seal design and suture management system
- Transparent body for easy visualization

---

### **CLEAR-TRAC FLEXIBLE**

Disposable Cannula System



- Flexible body material
- Integrated triple-seal design and suture management system
- Capped flow port



## Cannulas, Trocars and Obturators

### Diagnostic Cannula Sets

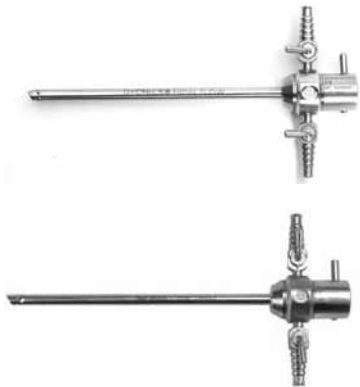

#### Diagnostic Cannula Sets

Reference #	Description
72200829*	6.0 mm High Flow Diagnostic Cannula, double-valve, rotatable
72200830	6.0 mm High Flow Diagnostic Cannula, single-valve, rotatable
8006653	O-ring for both cannulae
72201439	6.0 mm High Flow Diagnostic Cannula, single-valve, rotatable, for use with Stryker™ scopes
72201440	6.0 mm High Flow Diagnostic Cannula, double-valve, rotatable, for use with Stryker scopes
72201627	6.0 mm High Flow Diagnostic Cannula, single-valve, rotatable, for use with Storz™ scopes
72201628	6.0 mm High Flow Diagnostic Cannula, double-valve, rotatable, for use with Storz scopes
72201693	5.0 mm Medium Flow Diagnostic Cannula, single-valve, rotatable
72201712*	5.0 mm Medium Flow Diagnostic Cannula, double-valve, rotatable

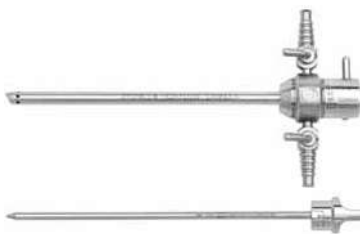

#### 6.0 mm High Flow Diagnostic Cannula Set, double-valve

Reference #	Description
3868	6.0 mm High Flow Diagnostic Cannula Set, double-valve, rotatable

#### Set includes

72200829	6.0 mm High Flow Diagnostic Cannula, double-valve, rotatable
4356	Obturator, conical tip



#### 6.0 mm High Flow Diagnostic Cannula Set, single-valve

Reference #	Description
7204711	6.0 mm High Flow Diagnostic Cannula Set, single-valve, rotatable

#### Set includes

72200830	6.0 mm High Flow Diagnostic Cannula, single-valve, rotatable
4356	Obturator, conical tip

\* Item shown

# Cannulas, Trocars and Obturators

## Operative Cannulas



### Operative Cannulas

Reference #	Description
3175*	4.5 mm Operative Cannula, no distal holes, for 4.0 mm arthroscopes with light post on OPPOSITE SIDE of direction of view
3673	4.5 mm Operative Cannula, distal holes, for 4.0 mm arthroscopes with light post on OPPOSITE SIDE of direction of view
2704*	4.5 mm Operative Cannula, distal holes, for 4.0 mm arthroscopes with light post on SAME SIDE of direction of view
3176*	5.5 mm Operative Cannula, no distal holes, for 4.0 mm arthroscopes with light post on OPPOSITE SIDE of direction of view
7204708	5.5 mm Operative Cannula, distal holes, for 4.0 mm arthroscopes with light post on OPPOSITE SIDE of direction of view
2711*	5.5 mm Operative Cannula, distal holes, for 4.0 mm arthroscopes with light post on SAME SIDE of direction of view
⚙️ 6900074	4.0 mm Operative Cannula for arthroscopes with light post on SAME SIDE of direction of view



### Operative Cannulas with Fluid Seals

For 4 mm DYONICS® Arthroscopes with light post on OPPOSITE SIDE of direction of view, J-Locking interface.



Reference #	Description
7205366*	5.5 mm Cannula, outflow valve, distal holes, with fluid seal
7205368	5.5 mm Cannula, outflow valve, no distal holes, with fluid seal
7205367	5.5 mm Cannula, finger post, distal holes, with fluid seal
7205369	5.5 mm Cannula, no distal holes, with fluid seal



### Operative Cannula Accessories

Reference #	Description
7204864	Infusion Adaptor with valve for inflow or outflow. Attaches to cannulas REF 3673, 7204708, 2704, 2711, 3175 and 3176
4536	Fluid seals (25 per package)
72200027	Fluid seals, sterile (25 per package)

\* Item shown

⚙️ Special, Made to Order products are available to meet the individual needs of surgeons. Please appreciate that longer lead time for delivery should be expected. For more information, please contact your sales representative or Customer Service.

# Cannulas, Trocars and Obturators

## Irrigation Extenders



### Irrigation Extenders

Reference #	Description
72200027	Fluid seals
72200831*	High Flow Irrigation Extender, double-valve, rotatable
72200832	High Flow Irrigation Extender, single-valve, rotatable
72201021	High Flow Irrigation Extender for cannulas with fluid seals, single-valve, rotatable



72201022*	High Flow Irrigation Extender for cannulas with fluid seals, double-valve, rotatable
-----------	--



### Irrigation Extenders

Reference #	Description
7205370*	Irrigation Extender for cannulas, with fluid seals, with outflow valve







7205371*	Irrigation Extender for cannulas, with fluid seals, rotatable
----------	---

# Cannulas, Trocars and Obturators

## Obturators and Trocars

### Obturators and Trocar

	Reference #	Description
	7205376	Obturator, blunt tip, fits all 4.5 mm, 6.0 mm and 6.0 mm diagnostic cannulas
	7204812	Obturator, blunt tip, fits all 6.0 mm diagnostic cannulas with Storz™ interface
	4356	Obturator, conical tip, fits all 4.5 mm and 5.8 mm diagnostic cannulas
	72200402	Obturator, conical tip, 4.5 mm with 1.5 mm, fits all 4.5 mm and 6.0 mm diagnostic cannulas
	7207701	Obturator, conical tip, fits all 6.0 mm diagnostic cannulas with Stryker™ interface
	7204811	Obturator, conical tip, fits all 6.0 mm diagnostic cannulas with Storz interface
	7209965	Obturator, conical tip, fits all 5.0 mm diagnostic cannulas
	1992*	4.5 mm Obturator, conical tip, fits all 4.5 mm operative cannulas
	2209*	5.5 mm Obturator, conical tip, fits all 5.5 mm operative cannulas
	7205783	5.5 mm Obturator, conical tip, for cannulas with fluid seals
	7205377	Trocar, sharp tip, fits all 4.5 mm and 6.0 mm diagnostic cannulas
	7204810	Trocar, sharp tip, fits all 6.0 mm diagnostic cannulas with Storz interface
	1995*	4.5 mm Trocar, sharp tip, fits all 4.5 mm operative cannulas
	7202210	5.5 mm Trocar, sharp tip, fits all 5.5 mm operative cannulas
	3801*	Switching Stick, 4.3 mm x 13"
	⚙ 6900734	Switching Stick, 2.9 mm (for REF 3781)
	⚙ 6900295Z	Switching Stick for 3.0 mm
	3802	Switching Sleeve, 4.5 mm x 10"
	2787	Wissinger Rod, 4.5 mm
	7205395	Nitinol Guide Wire, 1.2 mm x 45 cm, (3 per package)
	⚙ 72202791	3.0 mm Luer Cannula

### Outflow Cannula Set

	Reference #	Description
	7204910	Outflow Cannula Set

#### Set includes

7204863	3.0 mm Outflow Cannula with distal holes
7204865	Obturator, conical tip
⚙ 6900365	3.0 mm Trocar (SOD)

\* Item shown

⚙ Special, Made to Order products are available to meet the individual needs of surgeons. Please appreciate that longer lead time for delivery should be expected. For more information, please contact your sales representative or Customer Service.



# Cannulas, Trocars and Obturators

## Operative Cannula Sets – 4.5 mm



Light Post – OPPOSITE SIDE

Reference #	Description
3709	4.5 mm Operative Cannula Set for 4.0 mm arthroscopes with light post on OPPOSITE SIDE of direction of view

Set includes

3673	4.5 mm Operative Cannula (2 per set)
1995	4.5 mm Trocar, sharp tip
1992	4.5 mm Obturator, conical tip
3708	Irrigation Extender, single-valve, fixed
1986	Infusion Adaptor



Light Post – SAME SIDE

Reference #	Description
2701	4.5 mm Operative Cannula Set for 4.0 mm arthroscopes with light post on SAME SIDE of direction of view

Set includes

2704	4.5 mm Operative Cannula (2 per set)
1995	4.5 mm Trocar, sharp tip
1992	4.5 mm Obturator, conical tip
2705	Irrigation Extender, single-valve, fixed
1986	Infusion Adaptor



Light Post – OPPOSITE SIDE

Reference #	Description
4188	4.5 mm Rotatable Operative Cannula Set for 4.0 mm arthroscopes with light post on OPPOSITE SIDE of direction of view

Set includes

3673	4.5 mm Operative Cannula (2 per set)
1995	4.5 mm Trocar, sharp tip
1992	4.5 mm Obturator, conical tip
3814	Irrigation Extender, single-valve, rotatable
1986	Infusion Adaptor

⚙️ 6900391Z 4.5 mm Cannula with 6.0 mm distal holes

\* Item shown

## Cannulas, Trocars and Obturators

### Operative Cannula Sets – 5.5 mm



#### Light Post – SAME SIDE

Reference #	Description
-------------	-------------

3112	5.5 mm Operative Cannula Set for 4.0 mm arthroscopes with light post on SAME SIDE of direction of view
------	--

#### Set includes

2711	5.5 mm Operative Cannula (2 per set)
7202210	5.5 mm Trocar, sharp tip
2209	5.5 mm Obturator, conical tip
1986	Infusion Adaptor



#### Light Post – OPPOSITE SIDE

Reference #	Description
-------------	-------------

7204709	5.5 mm Operative Cannula Set for 4.0 mm arthroscopes with light post on OPPOSITE SIDE of direction of view
---------	--

#### Set includes

7204708	5.5 mm Operative Cannula (2 per set)
7202210	5.5 mm Trocar, sharp tip
2209	5.5 mm Obturator, conical tip
1986	Infusion Adaptor



#### Infusion Adaptor

Reference #	Description
-------------	-------------

1986	Infusion Adaptor
72200623	Infusion Adaptor with FMS inflow port (SOD)

## Hip Arthroscopy Set Cannulas and Obturators



ARTHROGARDE® Hip Access Cannulas are designed to be atraumatic, featuring smooth ends for optimal safety and high-strength design for enhanced durability.

The uniquely designed rounded ends provide a smooth surface to help protect soft tissue when performing hip arthroscopy. Plus, they're extra strong to prevent bending or wear and tear over time. Combine with our CROSSTRAC® Hip Guide System for accurate trajectories and first-time access to the hip joint.

Please note, all ARTHROGARDE Cannulas utilize J-SNAP Irrigation Extenders 72202448 or 72202449 at top of next page.

### ARTHROGARDE Hip Access Cannulas

Reference #	Description
72201741	4.5 mm ARTHROGARDE Hip Access Cannula, green (CROSSTRAC Hub)
72202003	4.5 mm ARTHROGARDE Hip Access Cannula, green (Standard Hub)
72201742	5.0 mm ARTHROGARDE Hip Access Cannula, blue (CROSSTRAC Hub)
72202004	5.0 mm ARTHROGARDE Hip Access Cannula, blue (Standard Hub)
72201743	5.5 mm ARTHROGARDE Hip Access Cannula, red
7209345	3.0 mm Cannula, inflow
72203133	ARTHROGARDE Slotted Cannula (4.4" working length)
72201590	ARTHROGARDE Slotted Cannula (6.2" working length)
⚙ 72203327	5.0 mm Extended Length ARTHROGARDE Hip Access Cannula, blue (Standard Hub)
⚙ 72203326	5.5 mm Extended Length ARTHROGARDE Hip Access Cannula, red (Standard Hub)

### Arthroscopic Hip Set Instrumentation – Obturators



Reference #	Description
72200884	4.5 mm Obturator, conical, green, used with REF 72201741 and 72202003
72200885	4.5 mm Obturator, cannulated, green, used with REF 72201741 and 72202003
72200096	4.5 mm Obturator, cannulated, green, large Delrin handle, used with REF 72201741 and 72202003
72200882	5.0 mm Obturator, conical, blue, used with REF 72201742 and 72202004
72200883	5.0 mm Obturator, cannulated, blue, used with REF 72201742 and 72202004
72200097	5.0 mm Obturator, cannulated, blue, large Delrin handle, used with REF 72201742 and 72202004
⚙ 72203329	5 mm Extended Length Obturator, cannulated, blue, large Delrin handle, used with REF 72203327
72200880	5.5 mm Obturator, conical, red, used with REF 72201743
72200881	5.5 mm Obturator, cannulated, red, used with REF 72201743
72200098	5.5 mm Obturator, cannulated, red, large Delrin handle, used with REF 72201743
⚙ 72203328	5.5 mm Extended Length Obturator, cannulated, red, large Delrin handle, used with REF 72203326
7207751	5.5 mm Obturator, long, cannulated, used with disposable cannula REF 7205360
7210392	5.5 mm Obturator, cannulated, used with slotted cannula REF 72201590
7209349	Obturator for 3.0 mm cannula
72201355	Reuseable Obturator for 5.7 mm Flexible Cannula (use with PN 7205360, 5.7 mm cannula)
7207934	Hip Arthroscopy System Sterilization Tray (21" x 10" x 3.5")

# Hip Arthroscopy Set

## Irrigation Extender



### Arthroscopic Hip Set Instrumentation – Irrigation Extender

Reference #	Description
72202448	J-SNAP quick release Irrigation Extenders, single-valve
72202449	J-SNAP quick release Irrigation Extenders, double-valve
72200027	Fluid Seals, sterile (25 per package)

---

## Extremity Cannula Sets

### Extremity Cannula Sets



#### 2.2 mm Operative Cannula Set for 1.9 mm SHORT SCOPE

Reference #	Description
4294	2.2 mm Operative Cannula Set for 1.9 mm SHORT SCOPE with light post on OPPOSITE SIDE of direction of view

#### Set includes

3865	2.2 mm Short Cannula, with flow port
3866	2.2 mm Short Trocar, sharp tip
3867	2.2 mm Short Obturator, conical tip
3312	TMJ/Wrist Probe



#### 2.9 mm Operative Cannula Set for 2.7 mm LONG SCOPE

Reference #	Description
3713	2.9 mm Operative Cannula Set for 2.7 mm LONG SCOPE with light post on OPPOSITE SIDE of direction of view

#### Set includes

3672	2.9 mm Short Cannula with finger post (2 per set)
3785	2.9 mm Short Trocar, sharp tip
3807	2.9 mm Short Obturator, conical tip
3671	Irrigation Extender, single-valve, fixed
3696	Infusion Adaptor
72203362	2.9 mm Blunt Obturator



#### 2.9 mm Operative Cannula Set for 2.7 mm SHORT SCOPE

Reference #	Description
3800	2.9 mm Operative Cannula Set for 2.7 mm SHORT SCOPE with light post on OPPOSITE SIDE of direction of view

#### Set includes

3781	2.9 mm Short Cannula with flow port (2 per set)
3807	2.9 mm Short Obturator, conical tip
3786	2.9 mm Short Obturator, blunt tip
3312	TMJ/Wrist Probe

## Extremity Cannula Sets

### Extremity Cannula Sets

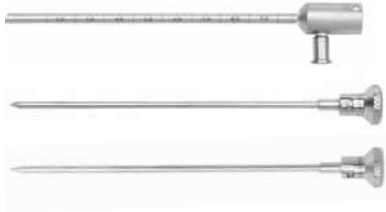

#### 2.9 mm Operative Cannula Set for 2.7 mm LONG SCOPE

Reference #	Description
-------------	-------------

3714	2.9 mm Diagnostic Cannula Set for 2.7 mm LONG SCOPE with light post on OPPOSITE SIDE of direction of view
------	---

#### Set includes

4419	2.9 mm Cannula with flow port
3691	2.9 mm Trocar, sharp tip
3692	2.9 mm Obturator, conical tip
72200411	2.9 mm Cannula, single-valve

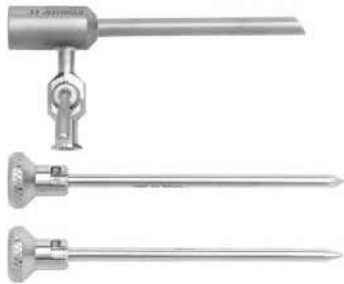

#### 3.6 mm Operative Cannula Set for 2.7 mm SHORT SCOPE

Reference #	Description
-------------	-------------

4317	3.6 mm Operative Cannula Set for 2.7 mm SHORT SCOPE with light post on OPPOSITE SIDE of direction of view
------	---

#### Set includes

4308	3.6 mm Operative Cannula, single-valve, fixed
4309	3.6 mm Sharp Trocar
4310	3.6 mm Obturator, conical tip (accommodates switching stick 6900734)

## Reusable Cannulas

### Reusable Cannulas



Reference #	Description
4482	4.0 mm Arthroscope Inflow Cannula Set for DYONICS® Arthroscopes with light post on OPPOSITE SIDE of direction of view

#### Set includes

4355	6.0 mm Rotatable Cannula with finger post
4356	Obturator, conical tip

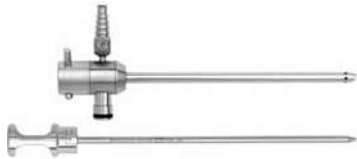

Reference #	Description
4549	4.0 mm Arthroscope Inflow Cannula Set with flush valve for DYONICS Arthroscopes with light post on OPPOSITE SIDE of direction of view

#### Set includes

4537	6.0 mm Rotatable Cannula with flush valve
4356	Obturator, conical tip

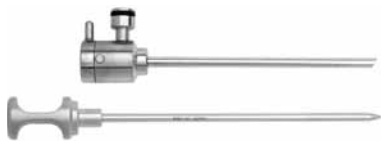

Reference #	Description
4481	2.7 mm Arthroscope Inflow Cannula Set standard length for DYONICS Arthroscopes with light post on OPPOSITE SIDE of direction of view

#### Set includes

4438	4.6 mm Rotatable Cannula with finger post
4439	Obturator, conical tip

Reference #	Description
⚙️ 6900392	2.9 mm Rotatable Cannula, low flow, double-valve (use with 2.7 mm standard arthroscope)
⚙️ 6900284	2.9 mm Obturator for 2.9 mm Cannula (6900392)

### Diagnostic Cannulas, Extended Length

For use with hip arthroscopy scopes REF 7211054 and 7211055

Reference #	Description
7211094	5.8 mm diagnostic cannula, with inflow and valve, rotatable
7207898	4.5 mm Cannulated obturator for cannulas 7211075 and 7207913
8011677	FMS port O-ring
⚙️ 7207913	5.8 mm Diagnostic cannula, double-valve, rotatable

## Reusable Cannulas



### Reusable Cannulas

Reference #	Description
4525	2.7 mm Arthroscope Inflow Cannula Set, short. For DYONICS® Arthroscopes with light post on OPPOSITE SIDE of direction of view

#### Set includes

4526	3.8 mm Rotatable Cannula with finger post
4527	Obturator, conical tip

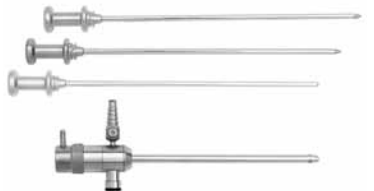

Reference #	Description
⚙ 7207789	3.8 mm Rotatable Cannula, single-valve, short
⚙ 7205984	3.8 mm Rotatable Cannula with inflow and valve
⚙ 7210715	3.8 mm Rotatable Cannula, double-valve, short

Reference #	Description
7205176	4.0 mm Storz™/Zimmer™/Linvatec™ Arthroscope Inflow Cannula Set for 4 mm arthroscopes with light post on OPPOSITE SIDE of direction of view

#### Set includes

7205874	6.0 mm Rotatable Cannula with inflow spring lock interface and flush valve
7204810	Trocar
7204811	Obturator, conical tip
7204812	Obturator, blunt tip



Reference #	Description
7204479	Non-scope Inflow Cannula

#### Set includes

4359	3.0 mm Inflow Cannula
7204478	Obturator, conical tip

### Inflow Cap for Cannulas

Reference #	Description
7209351	Inflow cap for cannulas, metal
72202442	Portal cap, Luer lock interface
⚙ 72202791	3.0 mm Luer Cannula



## Cannulas for Use with Arthroscopes

Use with 2.7 mm Arthroscopes, standard length

Reference #	Description
72200121	4.6 mm Rotatable Cannula, single-valve, standard length
7205999	4.6 mm Rotatable Cannula, double-valve, standard length
4439	Obturator, Conical Tip for 4.6 mm Rotatable Cannulas, standard length
72203536	3.8 mm Rotatable Cannula, single-valve, standard length
72201792	3.8 mm Rotatable Cannula, double-valve, standard length
7205993	Obturator, Conical Tip for 3.8 mm Rotatable Cannulas, standard length
72203624	2.9 mm Rotatable Cannula, double-valve, standard length
72203625	Obturator, Conical Tip for 2.9 mm Rotatable Cannulas, standard length

Use with 2.7 mm Arthroscopes, short length

Reference #	Description
7207789	3.8 mm Rotatable Cannula, single-valve, short length
7210715	3.8 mm Rotatable Cannula, double-valve, short length
4527	Obturator, Conical Tip for 3.8 mm Rotatable Cannulas, short length
6900513	Obturator, Blunt Tip for 3.8 mm Rotatable Cannulas, short length
72203138	Trocar, Sharp Tip for 3.8 mm Rotatable Cannulas, short length
72201751	2.9 mm Rotatable Cannula, double-valve, short length
72201752	Obturator, Conical Tip for 2.9 mm Rotatable Cannulas, short length

Use with 1.9 mm Arthroscopes, short length

Reference #	Description
72201849	2.2 mm Rotatable Cannula, double-valve, short length
72201197	Obturator, Conical Tip for 2.2 mm Rotatable Cannulas, short length

## Access Disposable Cannulas

### CLEAR-TRAC<sup>®</sup> COMPLETE Disposable Cannula System



#### CLEAR-TRAC COMPLETE Disposable Cannula System

The CLEAR-TRAC COMPLETE Cannula System is enhanced with a robust triple-seal design and an integrated suture management system. These new features, combined with the many existing facets from the previous generation, provide a truly comprehensive cannula solution.

- Integrated triple-seal design
- Suture management system
- Removable cannula cap
- Tall thread configuration
- Transparent polycarbonate body
- Latex-free design

#### CLEAR-TRAC COMPLETE Cannula Family (sterile, single-use, 10 per box)

Reference #	Description
72200902	8.5 mm x 90 mm Threaded Cannula, with disposable obturator, green, sterile
72200903	8.5 mm x 72 mm Threaded Cannula, with disposable obturator, green, sterile
72200904	8.5 mm x 45 mm Threaded Cannula, with disposable obturator, green, sterile
72200905	7.0 mm x 72 mm Threaded Cannula, with disposable obturator, grey, sterile
72200906	7.0 mm x 72 mm Smooth Cannula, with disposable obturator, grey, sterile
72200907	5.5 mm x 72 mm Threaded Cannula, with disposable obturator, blue, sterile
72200908	5.5 mm x 45 mm Threaded Cannula, with disposable obturator, blue, sterile
72200909	4.5 mm x 72 mm Threaded Cannula, with disposable obturator, purple, sterile

#### CLEAR-TRAC COMPLETE Reusable Obturators



Reference #	Description
72200910	8.5 mm x 90 mm Reusable Obturator (4.3 mm cannulation), green
72200913	8.5 mm x 90 mm Reusable Solid Obturator, green
72200911	8.5 mm x 72 mm Reusable Obturator (4.3 mm cannulation), green
72200912	8.5 mm x 72 mm Reusable Obturator (1.5 mm cannulation), green
72200914	8.5 mm x 72 mm Reusable Solid Obturator, green
72200915	7.0 mm x 72 mm Reusable Obturator (4.3 mm cannulation), grey
72200916	7.0 mm x 72 mm Reusable Obturator (1.5 mm cannulation), grey
72201796	5.5 mm Reusable Obturator (4.3 mm cannulation), blue

#### Accessories

3801	Switching Stick, 4.3 mm, not cannulated (13" long)
------	--

\* Item shown

⚙️ Special, Made to Order products are available to meet the individual needs of surgeons. Please appreciate that longer lead time for delivery should be expected. For more information, please contact your sales representative or Customer Service.

## Access Disposable Cannulas

### CLEAR-TRAC<sup>®</sup> FLEXIBLE Disposable Cannula System



#### CLEAR-TRAC FLEXIBLE Disposable Cannula System

The CLEAR-TRAC FLEXIBLE Cannula System is made from a flexible body material, it provides excellent tactile feedback to help identify structures and may reduce the risk of significant tissue damage. Enhanced with a robust triple-seal design. CLEAR-TRAC FLEXIBLE cannulas also feature an integrated suture management system.

- Integrated triple-seal design
- Suture management system
- Flexible body material
- Easy to thread, secure configuration
- Transparent body
- Capped flow port with optional disposable stopcock
- Latex-free design

#### CLEAR-TRAC FLEXIBLE Cannula Family (sterile, single-use, 10 per box)

Reference #	Description
72200424	8.0 mm x 90 mm Threaded Cannula, with disposable obturator, lime green, sterile
72200425	8.0 mm x 72 mm Threaded Cannula, with disposable obturator, lime green, sterile
72200426	8.0 mm x 72 mm Smooth Cannula, with disposable obturator, lime green, sterile
72200427	6.5 mm x 72 mm Threaded Cannula, with disposable obturator, orange, sterile
72200428	6.5 mm x 72 mm Smooth Cannula, with disposable obturator, orange, sterile
72200429	5.5 mm x 72 mm Threaded Cannula, with disposable obturator and trocar, blue, sterile
72200430	5.5 mm x 55 mm Threaded Cannula, with disposable obturator and trocar, blue, sterile
72200431	5.5 mm x 55 mm Smooth Cannula, with disposable obturator and trocar, blue, sterile
72200432	5.5 mm x 45 mm Threaded Cannula, with disposable obturator and trocar, blue, sterile
72200433	4.5 mm x 72 mm Threaded Cannula, with disposable obturator, purple, sterile

#### CLEAR-TRAC FLEXIBLE Reusable Obturators



Reference #	Description
72200899	8.0 mm x 90 mm Reusable Obturator (4.3 mm cannulation), lime green
72200900	8.0 mm x 72 mm Reusable Obturator (4.3 mm cannulation), lime green
72201796	5.5 mm Reusable Obturator (4.3 mm cannulation), blue
72201846	6.5 mm x 72 mm Reusable Obturator (4.3 mm cannulation)

#### Accessories

72200658	CLEAR-TRAC Disposable Stopcock
3801	Switching Stick, 4.3 mm, not cannulated (13" long)

\* Item shown

† Disposable knives are supplied as a box of 5, single-use, sterile packs.

## Disposable Cannulas

### CLEAR-TRAC<sup>®</sup> Cannulas



#### CLEAR-TRAC Scope/Shaver Cannula

The CLEAR-TRAC Disposable Scope/Shaver Cannula has been specifically designed with users of standard metal operative cannulas in mind. The unique hub design allows irrigation extenders and shaver blades to be connected directly to the cannula, while the integrated double-seal system keeps you dry.

Reference #	Description
72201634	CLEAR-TRAC Disposable Scope Shaver Cannula, smooth
72201658	CLEAR-TRAC Disposable Scope Shaver Cannula, with rib



#### CLEAR-TRAC Screw Cannula

Provides graft protection and aids screw delivery during graft fixation.

Reference #	Description
7210118*	7.0 mm CLEAR-TRAC Screw Cannula, latex seal
7210119	8.0 mm CLEAR-TRAC Screw Cannula, latex seal
7210120	9.0 mm CLEAR-TRAC Screw Cannula, latex seal
7207227	7.0 mm CLEAR-TRAC Screw Cannula, latex-free seal
7207228	8.0 mm CLEAR-TRAC Screw Cannula, latex-free seal
7207229	9.0 mm CLEAR-TRAC Screw Cannula, latex-free seal

*Single-use, sterile (10 per box)*



#### CLEAR-TRAC Threaded Cannula with Obturator

Reference #	Description
014718*	CLEAR-TRAC Threaded Cannula, 8.0 mm I.D., 76 mm long, green, latex-free seal
014719*	CLEAR-TRAC Threaded Cannula, 5.0 mm I.D., 76 mm long, blue, latex-free seal
7210121	CLEAR-TRAC Threaded Cannula, 8.0 mm I.D., 76 mm long, green, latex seal
7210122	CLEAR-TRAC Threaded Cannula, 5.0 mm I.D., 76 mm long, blue, latex seal

*Includes obturator. Single-use sterile packs (10 per box)*



#### CLEAR-TRAC Threaded Cannula with Cannulated Obturator

Reference #	Description
7207197	CLEAR-TRAC Threaded Cannula, 10 mm I.D., 76 mm long with 4.0 mm cannulated obturator, white, contains latex

*Includes cannulated obturator. Single-use sterile packs (10 per box)*

## Disposable Cannulas



### Disposable Cannula Sets with Distal Holes

Reference #	Description
4615	4.5 mm Cannula and Obturator, conical tip, distal holes, blue
4616	5.5 mm Cannula and Obturator, conical tip, distal holes, gray
4617	7.0 mm Cannula and Obturator, conical tip, distal holes, forest green

*70 mm working length, threaded with seals, latex free (6 per box)*



### Disposable Cannula Sets without Distal Holes

Reference #	Description
7204895	5.5 mm Cannula and Obturator, conical tip, no holes, orange
7204896	7.0 mm Cannula and Obturator, conical tip, no holes, lime green

*70 mm working length, threaded with seals, latex free (6 per box)*



### Universal Cannula – Includes Obturator and Trocar

Reference #	Description
014623	5.0 mm I.D., 55 mm long, blue, latex-free seal
012405	5.0 mm I.D., 76 mm long, blue, latex-free seal
012421	7.0 mm I.D., 76 mm long (includes obturator only), green, latex-free seal
7210126	5.0 mm I.D., 76 mm long, blue, latex seal

*Single-use sterile packs (10 per box)*

## Cannulae

5.5 mm Cannulae, color-coded blue, solid body, no fluid seals

**(same style as fluid seal cannulae but no seal needed)**

Reference #	Description
7209953	5.5 mm Cannula with distal holes and finger post same side as direction of view
7209954	5.5 mm Cannula with finger post same side as direction of view (no holes)
7209957	5.5 mm Cannula with distal holes and finger post opposite direction of view
7209958	5.5 mm Cannula with finger post opposite direction of view (no holes)
7210384	5.5 mm Blunt Obturator for 5.5 mm color-coded blue cannulae
72200013	5.5 mm Conical Obturator with threaded interface for 5.5 mm color-coded blue cannula
72200014	5.5 mm Trocar with threaded interface for 5.5 mm color-coded blue cannula
72200012	5.5 mm Blunt Obturator with threaded interface for 5.5 mm color-coded blue cannula

5.0 mm Cannulae, color-coded red, solid body, no fluid seals

**(same style as fluid seal cannulae but no seal needed)**

Reference #	Description
7209908	5.0 mm Cannula with finger post same side as direction of view (no holes)
7209956	5.0 mm Cannula with distal holes and finger post opposite direction of view
7209857	5.0 mm Cannula with finger post opposite direction of view (no holes)
7209923	5.0 mm Trocar for 5.0 mm color-coded red cannulae
7210385	5.0 mm Blunt Obturator for 5.0 mm color-coded red cannulae
72200010	5.0 mm Conical Obturator with threaded interface for 5.0 mm color-coded red cannula
72200011	5.0 mm Trocar with threaded interface for 5.0 mm color-coded red cannula
72200009	5.0 mm Blunt Obturator with threaded interface for 5.0 mm color-coded red cannula

2.7 mm Arthroscope Cannulae (standard length)

Reference #	Description
7205989	3.8 mm Cannula, FMS, rotatable, with flush-valve
6900154	4.6 mm Cannula, FMS, rotatable, with flush-valve. Used with Obturator (4439)

2.7 mm Arthroscope Cannulae (short length)

Reference #	Description
7205984	3.8 mm Cannula, FMS, rotatable, with flush-valve. Used with Obturator (4527)

# Cannulae

## Cannulae

Reference #	Description
⚙ 6900022Z	2.9 mm Cannula, short, with single-valve
⚙ 4491	4.5 mm Diagnostic Cannula, single-valve, rotatable
⚙ 7205372	4.5 mm Diagnostic Cannula, double-valve, fixed body
⚙ 3134300	4.5 mm, no holes, finger post opposite direction of view
⚙ 6900215Z	4.5 mm Cannula, operative, with finger post same side as direction of view
⚙ 6900237Z	5.0 mm Cannula with distal holes and finger post opposite direction of view
⚙ 6900084Z	5.5 mm Cannula with distal holes and finger post same side as direction of view
⚙ 6900167Z	5.5 mm Cannula with distal holes and finger post opposite direction of view
⚙ 6900092Z	5.5 mm Cannula with finger post opposite direction of view (no holes)
⚙ 6900106Z	5.5 mm Cannula with finger post same side as direction of view (no holes)
⚙ 72201374	6.0 mm High Flow Cannula, diagnostic, rotatable, single-valve, with Storz™ spring loaded interface
⚙ 72201375	6.0 mm High Flow Cannula, diagnostic, rotatable, double-valve, with Storz spring loaded interface

## Trocar

Reference #	Description
⚙ 6900279Z	5.5 mm Trocar for use with 5.5 mm Cannulae

## Irrigation Extenders

Reference #	Description
⚙ 7209959	Irrigation Extender for color-coded cannula sets, single valve, rotatable
⚙ 4493	Irrigation Extender, double-valve, rotatable
⚙ 72201451	Irrigation Extender, single-valve, rotatable, removable

## Miscellaneous

Reference #	Description
⚙ 6900274	3.0 mm Inflow Cannula with six distal holes. Used with Obturator (7204478)
⚙ 7210284	3.0 mm Inflow Cannula, 90°, no obturator

## Replacement O-Rings

### Quick Reference Chart

Cannulas	O-Ring: Scope Side	O-Ring: Cannula Side	O-Ring: FMS Port
3671	8006517		
3672	8006517		
3781	8006517		
3865	8010199 (2 each)		
3869	8006653		
4308	8003734		
4355	8006653		8011677
4359			8011677
4419	8006517		
4438	8010199		8011677
4491	8006653		
4492	8006653		
4526	8010199		8011677
4537	8006653		8011677
7205372	8006653		
7205874			8011677
72200829	8006653		
72200830	8006653		

Cannulas	O-Ring: Scope Side	O-Ring: Cannula Side	O-Ring FMS Port
2705	8006653	8006652 (2 each)	
3708	8006653	8006652 (2 each)	
3814	8006653	8006652 (2 each)	
4493	8006653	8006652 (2 each)	
7205370	8006653	8006652 (2 each)	
7205371	8006653	8006652 (2 each)	8011677
4355	8006653	8006652 (2 each)	8011677
72200083	8006653	8006652 (2 each)	
72200084	8006653	8006652 (2 each)	
72200004	8006653	8006652 (2 each)	8011677
4491	8006653		
4492	8006653		
4526	8010199		8011677
4537	8006653		8011677
7205372	8006653		
7205874			8011677
72200829	8006653		
72200830	8006653		



## ARTHROPAK

### Customized Procedure Kit



#### ARTHROPAK Customized Procedure Kit

Smith & Nephew DYONICS® ARTHROPAK Customized Procedure Kits provide increased operational efficiencies and reduced supply expense. You customize your kit with your selection of disposable Smith & Nephew products for any arthroscopic procedure at a reduced cost.

- Free customized service
- Reduced product cost
- Save valuable time and demand on staff
- Streamlined ordering process
- Increased standardization
- Reduced inventory

DYONICS ARTHROPAK Customized Procedure Kits reduce the number of SKUs that need to be ordered and aggregate purchasing volume of arthroscopic products by enabling purchase from a single supplier. Please ask your local sales representative to demonstrate how DYONICS ARTHROPAK Customized Procedure Kits can benefit your practice.



**DYONICS° 25**  
Fluid Management System



- Easy set up and use
- High flow
- Consistent performance

---

**DYONICS 25**  
Tube Sets



- A variety of tubing options are available, including cost-effective day tubing

## DYONICS<sup>◇</sup> 25 Fluid Management System



### DYONICS 25 Fluid Management System

The DYONICS 25 Fluid Management System is an easy to use, high-flow pump with consistent performance in all arthroscopic applications.

#### Easy to set up and use

- No calibration required
- Simply insert the tubing cassette and select the cannula size

#### High flow and consistent performance

- Flow rates up to 2.5 lpm
- Maintains stable pressure in the joint and also maintains clear field of view

#### Multiple tube set options

- A variety of tubing options are available, including day tubing, which enables selection of the most cost-effective solution for the facility

### DYONICS 25 Fluid Management System Control Unit

Reference #	Description
7211010	DYONICS 25 Fluid Management Control Unit (Control Unit only)



### DYONICS 25 Fluid Management Control Systems

Control Systems include a DYONICS 25 Control Unit, country-specific power cord, shaver interface cable, biomed test key, user manual and quick start guide.

Reference #	Description
72200207	DYONICS 25 Control System, US
72200210	DYONICS 25 Control System, UK
72200213	DYONICS 25 Control System, German
72200216	DYONICS 25 Control System, Spanish
72200219	DYONICS 25 Control System, French
72200222	DYONICS 25 Control System, Italian
72200225	DYONICS 25 Control System, Swedish
72200228	DYONICS 25 Control System, Dutch
72200231	DYONICS 25 Control System, Portuguese
72200234	DYONICS 25 Control System, Danish
72200237	DYONICS 25 Control System, Norwegian
72200552	DYONICS 25 Control System, Korean

#### Accessory

72200875	Software 1.41.08
----------	------------------

## DYONICS<sup>®</sup> 25 Fluid Management System Tube Sets and Accessories

### DYONICS 25 Fluid Management System Tube Sets

It is recommended that DYONICS High-flow Cannulas are used with the DYONICS 25 Fluid Management System to ensure optimum performance. Reference section C.



Reference #	Description	Qty
7211004	DYONICS 25 Inflow Tube Set	3 per box
7211005	DYONICS 25 Inflow/Outflow Tube Set, single suction	3 per box
7211006	DYONICS 25 Inflow/Outflow Tube Set, forked suction	3 per box
7211007	DYONICS 25 Day Tube Set (must be used with 7211008)	3 per box
7211008	DYONICS 25 Patient Tube Set (must be used with 7211007)	12 per box
7211009	DYONICS 25 Luer-to-Colder Adaptor	12 per box



### Accessories

Reference #	Description
7211011	LEVELERT <sup>®</sup> II Fluid Level Sensor (requires one 9 volt battery)
7211009	DYONICS 25 Luer-to-Colder Adapter (12 per box)
7220891*	DYONICS 25 Wireless Remote, non-autoclavable (requires two AA batteries)
7204483	Disposable multi bag adapters ("Y" tubing), sterile, 2 to a set (6 sets per box)
8005600	US power cord
8013378	UK power cord
8013380	International power cord
91000268	Shaver Interface Cable
91000290	Biomed Test Key

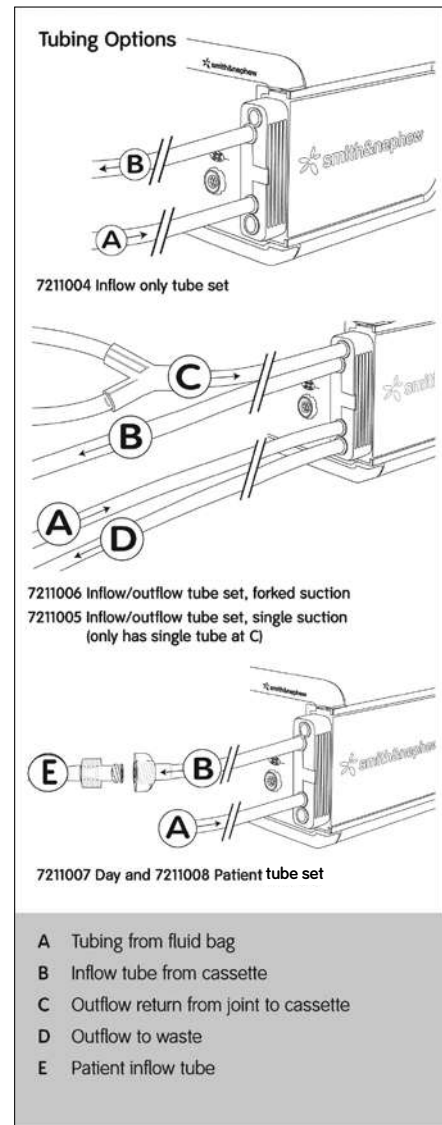

# DYONICS<sup>◇</sup> 25 Fluid Management System

## DYONICS 25 Carts



### DYONICS 25 Carts

Reference #	Description
7211014	Procedure Cart 17" W x 12.5" D x 35" H
72200747	Procedure cart with transformer and electrical outlets
72200888	Transformer upgrade kit (upgrades a 7211014 cart to a 72200747 cart)

## Irrigation Systems

### Access 15 Irrigation System



The Smith & Nephew Access 15 Irrigation System is the fast and easy system for accurate joint pressure management. The snap-on tubing cassette makes setup a simple one-hand operation. Advanced Flow Regulation (AFR) delivers optimal flow rates for stable and accurate in-joint pressure with any inflow setup. For optimum visualization, the system's wash function is designed both to clear debris and distend the joint immediately in the event of sudden fluid loss.

- Maximum flow rate of 1.5 L/min for procedural speed and efficiency
- Cost savings by conserving saline and reducing bag changes
- Wireless remote control for full-system control from the sterile field
- Remote foot pedal for easy operation of wash function

#### Access 15 Irrigation System

Reference #	Description
7205933	Access 15 System, US, 150 mmHg, includes control unit, remote control and power cord
7205697	Access 15 System Control Unit (Control Unit only)

#### Access 15 Tube Sets

Reference #	Description
7205699	Inflow-only disposable tube set for use with the Access 15 Irrigation System, sterile (10 per box)
7205931	Inflow/Outflow disposable tube set for use with the Access 15 Irrigation System, sterile (10 per box)

#### Access 15 Optional Accessories

Reference #	Description
7205797	Remote Control, wireless, operates all functions of the Access 15 Irrigation System. Additional remotes can be purchased separately
7204483	Disposable multi bag adapters ("Y" tubing), sterile, 2 to a set (6 sets per box)
7205798	Foot Pedal, operates wash function
7205932	Cart with irrigation poles to hang fluid bags

# ARTHROPAK

## Customized Procedure Kit



### ARTHROPAK Customized Procedure Kit

Smith & Nephew DYONICS® ARTHROPAK Customized Procedure Kits provide increased operational efficiencies and reduced supply expense. You customize your kit with your selection of disposable Smith & Nephew products for any arthroscopic procedure at a reduced cost.

- Free customized service
- Reduced product cost
- Save valuable time and demand on staff
- Streamlined ordering process
- Increased standardization
- Reduced inventory

DYONICS ARTHROPAK Customized Procedure Kits reduce the number of SKUs that need to be ordered and aggregate purchasing volume of arthroscopic products by enabling purchase from a single supplier. Please ask your local sales representative to demonstrate how DYONICS ARTHROPAK Customized Procedure Kits can benefit your practice.





---

## Notes

---

---

---

---

---

---

---

---

---

---

---

---

---

---

---

---

---

---

---

---

---

---

---

---

---

---

---



### VideoArthroscopes



- Wide-angle lens design for large field-of-view
  - Unparalleled brightness
  - Sapphire lenses for improved scratch resistance
- 

### Laparoscopes



- Stainless-steel construction to withstand sterilization modalities
- Sapphire distal lenses and rear ocular windows for improved scratch resistance

## VideoArthroscopes

### Autoclavable



#### VideoArthroscopes, Autoclavable

Indications: Arthroscopy and examination/treatment of nasal cavities and nasal pharynx

- Wide-angle lens design for a larger field-of-view
- Unparalleled brightness
- Sharp images throughout the entire field-of-view
- Lightweight construction
- Sapphire lenses for improved scratch resistance compared to conventional glass
- Compatible with Smith & Nephew autoclavable and non-autoclavable Camera Heads
- Validated for both steam and chemical (EtO and Sterrad™) sterilization modalities

#### VideoArthroscopes, Autoclavable, High Definition 560H only

Reference #	Outer Diameter	Direction of View	Field of View	Working Length	Light Post Direction	Cannula Connection	Recommended Light Cable
72202959*	4.0 mm	30°	115°	160 mm	Opposite	J-Lock	4.0 mm
72202958	4.0 mm	70°	115°	160 mm	Opposite	J-Lock	4.0 mm

#### Accessories

Reference #	Description
7205548	Aluminum oxide vial for cleaning autoclavable endoscope lenses
7210721	Protective cap for autoclavable scopes (fits 4.0 mm and 5.5 mm scopes, package of 70)
8001701	Replacement O-ring for C-mount VideoArthroscopes
81010296	Replacement O-ring for 7210716

\* Item shown

## VideoArthroscopes

### Non-Autoclavable



#### VideoArthroscopes, Non-Autoclavable

Indications: Arthroscopy and examination/treatment of nasal cavities and nasal pharynx

- Stainless steel construction to withstand chemical sterilization modalities (EtO and Sterrad™)
- Wide angle of view
- Ergonomically designed to directly attach to the camera head for ease of use and reduce number of interface where fogging could occur
- Insertion needle is fully rotatable without the need to reposition the camera head
- Compatible with Smith & Nephew Non-Autoclavable Camera Heads (C-Mount), as listed below

#### Black Focus Ring, 19.5 mm focal length

Reference #	Outer Diameter	Direction of View	Field of View	Working Length	Light Post Direction	Cannula Connection	Recommended Light Cable
72202961	4.0 mm	30°	115°	160 mm	Opposite	J-Lock	4.0 mm
72202962	4.0 mm	70°	115°	160 mm	Opposite	J-Lock	4.0 mm
72202963	4.0 mm	30°	115°	160 mm	Same Side	J-Lock	4.0 mm
⚙️ 72202964	4.0 mm	70°	115°	160 mm	Same Side	J-Lock	4.0 mm

Note: These non-autoclavable HD VideoArthroscopes for use only with the Smith & Nephew 560 HD camera heads.

#### Black Focus Ring, 25 mm focal length

Reference #	Outer Diameter	Direction of View	Field of View	Working Length	Light Post Direction	Cannula Connection	Recommended Light Cable
⚙️ 4486	4.0 mm	30°	115°	160 mm	Same Side	J-Lock	4.0 mm

Note: These non-autoclavable HD VideoArthroscopes for use only with the Smith & Nephew 560 HD camera heads.

#### Blue Focus Ring, 35 mm focal length

Reference #	Outer Diameter	Direction of View	Field of View	Working Length	Light Post Direction	Cannula Connection	Recommended Light Cable
72202956	4.0 mm	30°	115°	160 mm	Opposite	J-Lock	4.0 mm
3766	4.0 mm	30°	115°	160 mm	Same Side	J-Lock	4.0 mm
3628	4.0 mm	70°	115°	160 mm	Opposite	J-Lock	4.0 mm
3632	2.7 mm	30°	90°	120 mm	Opposite	J-Lock	4.0 mm
3768	2.7 mm	30°	90°	67 mm	Opposite	J-Lock	4.0 mm
3863	1.9 mm	30°	75°	65 mm	Opposite	J-Lock	2.0 mm
⚙️ 7210987	1.9 mm	30°	75°	65 mm	Opposite	J-Lock	4.0 mm
⚙️ 3797	2.7 mm	70°	90°	70 mm	Opposite	J-Lock	4.0 mm

Note: These VideoArthroscopes for use only with the Smith & Nephew ED3, 360, 460 and HD900 camera heads.  
Not compatible with the Smith & Nephew 470 or 560 camera heads

Reference #	Description
8001701	Replacement O-ring for C-mount VideoArthroscopes

## VideoArthroscopes

### Non-Autoclavable



#### VideoArthroscopes, Non-Autoclavable

Indications: Arthroscopy and examination/treatment of nasal cavities and nasal pharynx

- Stainless steel construction to withstand sterilization modalities (EtO and Sterrad™)
- Wide angle of view
- Ergonomically designed to directly attach to the camera head for ease of use and reduce number of interfaces where fogging could occur
- Insertion needle is fully rotatable without the need to reposition the camera head
- Compatible with Smith & Nephew Non-Autoclavable Camera Heads (C-Mount)

Black Focus Ring, 25 mm focal length

Reference #	Outer Diameter	Direction of View	Field of View	Working Length	Light Post Direction	Cannula Connection	Recommended Light Cable
4125†	4.0 mm	30°	115°	160 mm	Opposite	J-Lock	4.0 mm
4126†	4.0 mm	70°	115°	160 mm	Opposite	J-Lock	4.0 mm
4130*‡	2.7 mm	30°	90°	120 mm	Opposite	J-Lock	4.0 mm
4131‡	2.7 mm	30°	90°	67 mm	Opposite	J-Lock	4.0 mm
4132‡	2.7 mm	70°	90°	70 mm	Opposite	J-Lock	4.0 mm
7208133‡	1.9 mm	30°	75°	62 mm	Opposite	J-Lock	2.0 mm

\* Item shown

† Not HD compatible

‡ HD and non-HD compatible

## Direct-View Arthroscopes

### Autoclavable



#### Direct-View Arthroscopes, Autoclavable

Indications: Arthroscopy and examination/treatment of nasal cavities and nasal pharynx

- Fully autoclavable, with both distal and proximal ends soldered for increased durability
- Wide angle of view
- Autoclavable arthroscopes have sapphire distal lenses and rear ocular windows for greater scratch resistance than conventional glass
- Stainless steel construction to withstand sterilization various modalities (EtO, Sterrad™ and autoclave)

Reference #	Outer Diameter	Direction of View	Field of View	Working Length	Light Post Direction	Cannula Connection	Recommended Light Cable
72202087*	4.0 mm	30°	115°	160 mm	Opposite	J-Lock	4.0 mm
72202088*	4.0 mm	70°	115°	160 mm	Opposite	J-Lock	4.0 mm
7208132	4.0 mm	30°	115°	175 mm	Opposite	Storz™	4.0 mm
7205682	2.7 mm	30°	90°	67 mm	Opposite	J-Lock	4.0 mm
7205681	2.7 mm	30°	80°	120 mm	Opposite	J-Lock	4.0 mm
72201597*	4.0 mm	30°	115°	278 mm	Opposite	J-Lock	4.0 mm
72201598*	4.0 mm	70°	115°	280 mm	Opposite	J-Lock	4.0 mm
⚙ 72202958	4.0 mm	45°	115°	157 mm	Opposite	J-Lock	4.0 mm
⚙ 72202090	4.0 mm	0°	115°	160 mm	Opposite	J-Lock	4.0 mm
⚙ 7210694	2.7 mm	0°	80°	67 mm	Opposite	J-Lock	4.0 mm
⚙ 7210910	2.7 mm	0°	80°	120 mm	Opposite	J-Lock	4.0 mm
⚙ 72200733	2.7 mm	70°	80°	119 mm	Opposite	J-Lock	4.0 mm
⚙ 72201747	2.7 mm	30°	80°	67 mm	Same side	J-Lock	4.0 mm

Note: Compatible with all camera heads with couplers

## Direct-View Arthroscope

### Non-Autoclavable



#### Direct-View Arthroscope, Non-Autoclavable

Indications: Arthroscopy and examination/treatment of nasal cavities and nasal pharynx

- Wide angle of view
- Stainless steel construction to withstand sterilization modalities (EtO and Sterrad™)

Reference #	Outer Diameter	Direction of View	Field of View	Working Length	Light Post Direction	Cannula Connection	Recommended Light Cable
4184	1.9 mm	30°	80°	67 mm	Opposite	J-Lock	2.0 mm
⚙️ 3948	2.7 mm	70°	90°	70 mm	Opposite	J-Lock	4.0 mm

For use with hip arthroscopy scopes REF 72201597 and 72201598 on previous page.

Reference #	Description
72201816	6.0 mm diagnostic cannula, double valve, rotatable
72201898	4.5 mm cannulated obturator for cannula 72201816
7205548	Aluminum oxide vial for cleaning autoclavable endoscope lenses
7210721	Protective cap for autoclavable scopes (fits 4.0 mm and 5.5 mm scopes, package of 70)



## Specialty Endoscopes

### ECTRA<sup>®</sup> II Carpal Ligament System and Replacement Parts

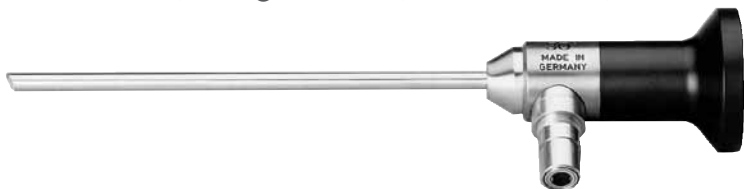

#### ECTRA II

Indications: Endoscopic release of carpal ligament, plantar fascia and the extra-articular lateral ligament

- Wide angle of view
- Stainless steel construction to withstand sterilization modalities (EtO and Sterrad™)

Reference #	Outer Diameter	Direction of View	Field of View	Working Length	Light Post Direction	Cannula Connection	Recommended Light Cable
4144*	Direct-View	4.0 mm	30°	100°	106 mm	Same Side	4.0 mm
3896	Video	4.0 mm	30°	100°	106 mm	Same Side	4.0 mm
⚙️ 4139Z	Video	4.0 mm	30°	115°	106 mm	Same Side	4.0 mm

#### Replacement Parts

Light post Adaptor Sleeve: Fits all Arthroscopes, Hysteroscopes/Cystourethroscopes, and Laparoscopes with 4 mm light post

Reference #	Description
7207900*	For Storz™ Light Guide, outside threads, full length



4347*	For Smith & Nephew/Wolf™ Light Guide
8001701	Replacement O-ring for C-mount VideoArthroscopes



\* Item shown

⚙️ Special, Made to Order products are available to meet the individual needs of surgeons. Please appreciate that longer lead time for delivery should be expected. For more information, please contact your sales representative or Customer Service.

## Laparoscopes

### Direct-View Autoclavable Laparoscopes

- Stainless steel construction to withstand sterilization modalities (autoclave, EtO and Sterrad™)
- Fully autoclavable, with both distal and proximal ends uniquely soldered for longevity
- Autoclavable laparoscopes have sapphire distal lenses and rear ocular windows for much greater scratch resistance than conventional glass
- Indications include thoracic surgeries

Reference #	Outer Diameter	Direction of View	Field of View	Working Length	Recommended Light Cable
72202463	10 mm	0°	81°	330 mm	5.0 mm
72202464	10 mm	30°	81°	330 mm	5.0 mm
72202465	10 mm	45°	81°	330 mm	5.0 mm
72202110*	5.5 mm	0°	84°	290 mm	5.0 mm
72202111	5.5 mm	30°	84°	290 mm	5.0 mm
72202112	5.5 mm	45°	84°	290 mm	5.0 mm
7208333†	5.0 mm	0°	84°	290 mm	4.0 mm
7208332†	5.0 mm	30°	84°	290 mm	4.0 mm

### Direct-View Autoclavable Bariatric Laparoscopes

- Stainless steel construction to withstand sterilization modalities (autoclave, EtO and Sterrad)
- Fully autoclavable, with both distal and proximal ends uniquely soldered for longevity
- Autoclavable laparoscopes have sapphire distal lenses and rear ocular windows for much greater scratch resistance than conventional glass
- Indications include bariatric surgeries

Reference #	Outer Diameter	Direction of View	Field of View	Working Length	Recommended Light Cable
7211077	10 mm	30°	84°	450 mm	6.0 mm
7211078	10 mm	0°	84°	450 mm	6.0 mm
7211079	10 mm	45°	84°	450 mm	6.0 mm
⚙️ 7208328Z†	5.0 mm	30°	84°	290 mm	4.0 mm

### MicroLaparoscopes

- Stainless steel construction to withstand sterilization modalities (EtO and Sterrad)
- Indications include general and gynecological laparoscopic procedures

Reference #	Outer Diameter	Direction of View	Field of View	Working Length	Recommended Light Cable
⚙️ 7208334Z	3.0 mm	0°	80°	277 mm	4.0 mm

\* Item shown

† Indications include harvesting of superficial vessels of the lower extremities.

## Laparoscopes

### Direct-View Operative Laparoscopes and Accessories



#### Direct-View Operative Laparoscopes

- Stainless steel construction to withstand sterilization modalities (Steam Autoclave, EtO and Sterrad™)
- Wide angle of view
- Indications include general and gynecological laparoscopic procedures

Reference #	Outer Diameter	Direction of View	Eyepiece Offset	Working Length	Operating Channel	Recommended Light Cable
7205549*	10 mm	0°	90°	270 mm	5 mm	5.0 mm
⚙️ 7205466	10 mm	0°	45°	270 mm	5 mm	5.0 mm

## Endoscope and Laparoscope Accessories

#### Accessories for Autoclavable Endoscopes

Reference #	Description
7205548	Aluminum oxide vial for cleaning autoclavable endoscope lenses
7210721	Protective cap for autoclavable scopes (fits 4.0 mm and 5.5 mm scopes, package of 70)

#### Direct-View Operative Laparoscope Accessories

Reference #	Description
7205560	Replacement Stopcock, 45° offset
7205777	Replacement Stopcock, 90° offset
7205561	Replacement Seal Caps (5 per box)

\* Item shown

⚙️ Special, Made to Order products are available to meet the individual needs of surgeons. Please appreciate that longer lead time for delivery should be expected. For more information, please contact your sales representative or Customer Service.

## Hysteroscopes, Cystourethrosopes and Hysteroscopic Sheaths



Light post opposite direction of view

Direct-View Autoclavable Hysteroscopes/Cystourethrosopes†

Light post opposite direction of view. Stainless steel construction to withstand sterilization modalities (Autoclave, EtO and Sterrad™)

Reference #	Outer Diameter	Direction of View	Field of View	Working Length	Sheath Style	Recommended Light Cable
7205463	4.0 mm	0°	101°	300 mm	Storz™	4.0 mm
7205465*	4.0 mm	30°	101°	300 mm	Storz	4.0 mm
7205462	4.0 mm	70°	101°	300 mm	Storz	4.0 mm

† Indications for Use: Hysteroscopes and accessories (Operative Hysteroscopic Sheath) are used to permit viewing of the cervical canal and the uterine cavity for the purpose of performing diagnostic and surgical procedures. Cystourethrosopes are indicated for use in the examination of the bladder, urethra, and distal ureter, and, using additional accessories, to perform various diagnostic and therapeutic procedures.

### Hysteroscopic Sheaths



Reference #	Description
4512	5.0 mm Diagnostic Hysteroscopic Sheath, 15 Fr, single stopcock
7204513	7.0 mm Operative Hysteroscopic Sheath, 21 Fr, with one 2.9 mm working channel, double stopcocks





### 560P Camera

Control Unit and Camera Head



- Optimal HD image quality, broadcast quality, color reproduction and versatility
- Compatible with the latest in digital technology
- Delivers all aspects of high-quality surgical imagery for every endoscopic procedure



## Camera Systems

### 560P Camera Control Unit and 560H Camera Head



#### 560P Camera Control Unit

The 560P Camera Control Unit (CCU) provides optimal high definition image quality, broadcast quality color reproduction and versatility for all endoscopic procedures in the OR setting. Compatible with the latest in digital technology with full 1080 output in DVI, HD-SDI, and YPrPb and a powerful user menu for customization. This new generation also features control of the 500XL and USB recording of live, streaming video in MPEG format.

Reference #	Description
72201919*	560P Camera Control Unit, High Definition Camera System (Control Unit only)

#### 560P Camera Control Unit Systems

Reference #	Description
<b>Systems include</b>	
560P Camera Control Unit, power cord, HD-SDI cable, RG-59 10' and country specific manual	
72202328	560P Camera Control Unit, NTSC/PAL, US
72202342	560P Camera Control Unit, NTSC/PAL, German
72202352	560P Camera Control Unit, NTSC/PAL, Spanish
72202340	560P Camera Control Unit, NTSC/PAL, French
72202344	560P Camera Control Unit, NTSC/PAL, Italian
72202354	560P Camera Control Unit, NTSC/PAL, Swedish
72202350	560P Camera Control Unit, NTSC/PAL, Portuguese
72202336	560P Camera Control Unit, NTSC/PAL, Danish
72202348	560P Camera Control Unit, NTSC/PAL, Norwegian
72202338	560P Camera Control Unit, NTSC/PAL, Dutch
72202346	560P Camera Control Unit, NTSC/PAL, Korean
72202332	560P Camera Control Unit, NTSC/PAL, UK
72202330	560P Camera Control Unit, NTSC/PAL, International
72202334	560P Camera Control Unit, NTSC/PAL, Chinese

#### 560 Camera System

Reference #	Description
72200571	Camera System, 560, NTSC/PAL, US
72200559	Camera Control Unit, 560, HD
72200589	Kit, 560, HD, CCU, US



#### 560H Non-autoclavable Camera Head

560H broadcast high definition camera head is compatible with a complete line of Smith & Nephew HD VideoArthroscopes and HD couplers. Provides for 3 button (6 function) control of CCU, peripheral devices, printers and 660 HD Image Management Systems.

Reference #	Description
72200561*	560H Camera Head, HD, NTSC/PAL

## Camera Systems

### HD1200 Autoclavable Camera System



#### HD1200 Camera System

The HD1200 Autoclavable Camera System is designed to provide HD quality and quick-cycle autoclavable sterilization to facilities with limited sterilization access.

- Economical†, quick-turn sterilization camera head – 4 min. 132–137° C cycle
- Selectable HD outputs of 1080i, 1080p or 1200p with C-mount, 1/3" 3CCD design
- Compatible with all current Smith & Nephew HD optics

#### HD1200 Autoclavable Camera Systems

Reference #	Description
72203388	HD1200 Autoclavable Camera System, US
72203389	HD1200 Autoclavable Camera System, UK



#### Available Separately

72203361	HD1200 Camera Control Unit
72203360*	HD1200 Camera Head
72203418	Digital to Analog Converter Box (Gefen™)

\* Item Shown

+ Compared to liquid chemical sterilization. Data on file at Smith & Nephew



## ACL/PCL Reconstruction Drill Guide Systems

### ACUFEX<sup>®</sup> DIRECTOR APPLICATION Anatomic Guide

Use of the ACUFEX DIRECTOR APPLICATION Anatomic Guide has been shown to result in more anatomic, more consistent cruciate ligament tunnel placement.<sup>1</sup> Through the use of fluoroscopy the guide allows surgeons to reproducibly define the geometric insertion points of the anteromedial and posterolateral bundles independently of the size and shape of the knee.<sup>1,2</sup>

#### Real-time visualization enables more anatomic accuracy

- Gain insight of the anatomy of the insertion site on femur and tibia
- Overcome skeletal variation among patients
- Evaluate anatomic accuracy of tunnel placement before, during and after a procedure
- Facilitate optimal patient outcomes<sup>1,2</sup>

#### Selectable overlay options support a variety of procedures

- Customizable femoral grid
- Single-bundle
- Double-bundle

#### ACUFEX<sup>®</sup> DIRECTOR APPLICATION Anatomic Guide

Reference #	Description
72203260	ACUFEX Director Application, Anatomic Guide System

#### System includes

72203204	ACUFEX Director Application touchpanel, software and keyboard tray
72203203	Adjustable height rolling monitor stand



#### Technique Example

Customizable single-bundle ACL femoral grid overlay option - radiographic quadrant method adapted from Bernard and Hertel

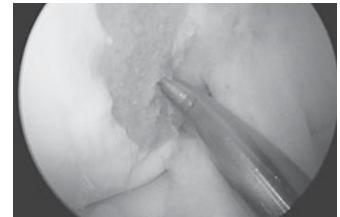

Mark intended femoral tunnel location with microfracture awl



Capture lateral x-ray image from C-arm



Use touchscreen or mouse to select the three key anatomic landmarks on the condyle e.g.

- Blumensaat's line – anterior
- Blumensaat's line – posterior
- Notch on condyle

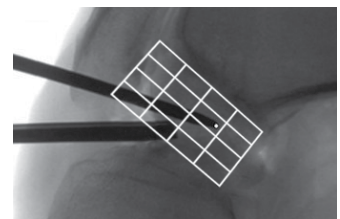

ACUFEX DIRECTOR APPLICATION Anatomic Guide automatically generates overlay

<sup>1</sup> UPMC Cadaver Study (ongoing)

<sup>2</sup> Zantop T, et al. Tunnel positioning of anteromedial and posterolateral bundles in anatomic anterior cruciate ligament reconstruction: Anatomic and radiographic findings. The American Journal of Sports Medicine 2007. DOI: 10.1177/0363546507308361



## 660HD Image Management System



- Enables OR staff to capture, edit, print and store intraoperative surgical images and video
- Easy-to-use digital capture system

---

## Endocouplers



- Superior clarity and brightness
- Optimal picture quality
- Convenient one-finger scope attachment

## Video Image Capture Devices

### 660HD Image Management System



The 660HD Image Management System is an easy-to-use digital capture system that enables the OR staff to capture, edit, print and store intraoperative surgical images and video.

#### 660HD Image Management System

Reference #	Description
72200242	660HD Image Management System (system only - does not include manual or cord)
72200812	660HD Image Management System, English on-screen display and Operations/Service Manual, US power cord
72200814	660HD Image Management System, multi-language on-screen display and Operations/Service Manual, continental power cord
72200816	660HD Image Management System, English on-screen display and Operations/Service Manual, UK

#### Country Kits

Reference #	Description
72200813	US Kit
72200815	International Kit
72200817	UK Kit

#### Accessories

Reference #	Description
7209339	Single-pedal footswitch
7209340	Dual-pedal footswitch
7210534	DVD-R media
7210533	Premium photo paper, high-gloss, 50 sheets
72201745	Premium photo paper, soft-gloss, 50 sheets
72200204	HP 99 Photo Inkjet Print Cartridge with Vivera Ink
72200205	HP 97 Tri-color Inkjet Print Cartridge, high volume
72201079	Integration Broker Software, HL7
72201081	Integration Broker Software, DICOM
72200813	US 660HD Kit (manual and cord)
90500817	Extra Stylus, package of 5
10600055	Operations/Service Manual
72201078	Software, version 1.5 (4-1-11)

## Video Monitors



Smith & Nephew flat panel displays are optimized for use with the full range of Smith & Nephew video cameras and are part of recommended Smith & Nephew visualization system configurations. These flat panel displays offer exceptionally bright and crisp high-resolution images, ensuring superior reproduction of anatomical detail. Full HD widescreen displays deliver the full resolution of the Smith & Nephew 560 HD camera, 1920x1080i.

### HD Widescreen, 16:9, Flat Panel Displays

Reference #	Description
72201421	24" Widescreen HD (Sony™), CCD, LCD
72201422	24" Widescreen HD (Sony™), CCD, LCD, UK
72201423	24" Widescreen HD (Sony™), CCD, LCD, International
72202026	32" Widescreen HD (Sony™), CCD, LCD
72202027	32" Widescreen HD (Sony™), CCD, LCD, UK
72202028	32" Widescreen HD (Sony™), CCD, LCD, International
72203700	24" NDS HD (Barco™), CCD
72203701	24" NDS HD (Barco), CCD, UK
72203702	24" NDS HD (Barco), CCD, International

### HD Compatible Flat Panel Displays

Reference #	Description
72201434	19" HD Compatible 5:4 square LCD
72201435	19" HD Compatible 5:4 square LCD, UK
72201436	19" HD Compatible 5:4 square LCD, International

### Desktop Monitor Stand

Reference #	Description
72200019	Desktop Monitor Stand for LCDs below 25 inches, Sony SU-560

### Power Supplies

Reference #	Description
72203005	24" Sony
90504533	Power Supply, Sony AC-110MD
90502965	Adapter, Power Supply Sony 24" (used with REF 72201421)
90504109	Power Supply for 32" Flat Panel Displays

NOTE: Power supplies included with New and F suffix Sony monitors. Not included in service orders.

## Video Printers and Recorders

### Video Printers and Recorders



Reference #	Description
72202024	UP-55MD/HD A5 Color Video Printer by Sony™, NTSC/PAL, RGB, S-VHS, composite video, compatible with Smith & Nephew digital camera head control buttons, medical grade, 8MB memory, 100–240 VAC



72201464	HP 6940 plain paper printer. Up to 6 pages per minute in normal color mode, 30 pages per minute in draft color mode. Optional high-capacity ink cartridges so fewer cartridge changes are needed. 16 mb memory. Up to 4800-optimized dpi for professional photo quality. Advanced control panel with ink status display and print quality selector.
----------	---

### Printer Ink

Reference #	Description
7210529	HP 6122 Ink (HP 45 REF 7220531), (HP 78 REF 7210532)
72200035	HP 6540 Ink (HP 97 REF 72200205), (HP 99 REF 72200204)
72202020	HP 7460 Ink (72202021 color, 72202022 black)
72202023	HP 6988 Ink (HP 97 REF 72200205), (HP 99 REF 72200204)
72201464	HP 6940 Ink (HP97 REF 72200205), HP 99 REF 72200204)
72202020	HP 7260 Ink (72202022 black, HP C9500FN colored), (72202021 HP CC604FN colored)

NOTE: HP 7260 and HP 7460 do not have Smith&Nephew part numbers.  
Please use HP ink numbers 56, 57 or 58.

## Video Printer Paper and Printer Accessories

### Video Printer Paper

Reference #	Description
72200993	Color printing pack for Sony™ UP-55MD printer (REF 72200992), 1 pack includes 2 bags of print paper (100 each) and 2 color ribbon refills.
7207802	Sony part # UPC-510, color printing pack for Sony UP-51MD/MDU series printers (Smith & Nephew REF 7207801); 1 pack includes 2 bags of print paper (100 each) and ink ribbon; 200 prints per pack
7204983	Sony part # UPC-5510, color printing pack for Sony UP-5600MD series printers (Smith & Nephew REF 7204973); 1 pack includes 2 bags of print paper (100 each) and ink ribbon; 200 prints per pack
7206058	Sony part # UPC-5510C, color printing pack for Sony UP-5600MD series printers (Smith & Nephew REF 7204973); 1 pack includes 2 bags of print paper (100 each) and 1 disposable ribbon-loaded cartridge; 200 prints per pack

*NOTE: Smith & Nephew, Inc. is a recognized Sony distributor. All Sony products not shown in this catalog are available upon request.*

7210533	HP Premium Plus High Gloss Photo Paper, 8.5" x 11", 50 sheets per package
72201745	HP Premium Plus Photo Paper, 50 sheets per package

### Printer Accessories

Reference #	Description
72200204	HP High Volume Ink Cartridge, black 21 ml, for use with REF 72200035
72200205	HP High Volume Ink Cartridge, color 14 ml, for use with REF 72200035

## Video Couplers and Adapters

### Non-Autoclavable Endocouplers

- Superior clarity and brightness
- Optimal picture quality
- Ease-of-use: convenient one-finger scope attachment
- Compatible with EtO and Sterrad™ sterilization modalities



Reference #	Description
72201635	Coupler, High Definition, Non-autoclavable, 19.5 mm, Black ring
72201730	Coupler, High Definition, Non-autoclavable, 26.0 mm, Silver ring



Reference #	Description
7204613	C-Mount, 25 mm Coupler (black focus ring)
7204823*	C-Mount, 30 mm Coupler (gold focus ring)
7204614	C-Mount, 35 mm Coupler (blue focus ring)



Reference #	Description
7205461*	C-Mount Zoom Coupler, 25-45 mm, for use with Smith & Nephew Digital 3-Chip Camera Models D3, ED-3 and HD 460H



Reference #	Description
4533*	C-Mount, 35 mm, 90° Urology Coupler, free-floating (lockable), rotating head
72201699	HD, 16 mm, 90° Urology Coupler with rotating head



Reference #	Description
4464*	C-Mount, 25 mm Beamsplitter, free-floating (lockable), rotating head



Reference #	Description
⚙️ 7209042*	C-Mount, 25 mm, 90° Urology Coupler, free-floating (lockable), rotating head, for 4.0 mm and 5.0 mm endoscopes

### Replacement Parts

Reference #	Description
8001701	Replacement O-ring for Videoscopes and C-Mount coupler
8012760	Replacement O-ring for V-Mount coupler
8006333	Replacement O-ring for C-Mount Zoom Coupler

\* Item shown



## Video Couplers and Adapters

### Autoclavable Couplers

- Superior clarity and brightness
- Unparalleled brightness
- Sharp images throughout the entire field-of-view
- Sapphire lenses for improved scratch resistance over conventional glass
- Epoxy-free, proprietary seal design guarantees leak-free autoclave performance
- Compatible with steam and chemical (EtO and Sterrad™) sterilization modalities



### High Definition Endocouplers – 560H head only

Reference #	Description
72200315	19.5 mm High Definition, C-mount, Black ring
72200422	26.5 mm High Definition, C-mount, Silver ring



### Standard Definition Endocouplers

Reference #	Description
7210192	18 mm Smith & Nephew mount for use with 370 and 470H Camera Heads only
81010296	Replacement O-ring for Endocouplers

# Video and Accessory Cables

## Video and Accessory Cables

Reference #	Description
7206083	Accessory Control Cable, mini-phono to mini-phono, for use with 325Z, ED-3, and HD900 Video Cameras for remote connection with Video Printers (Smith & Nephew REF 7207812 and 7206094) Video Cassette Recorder and Smith & Nephew 600-series Image Management System
⚙ 4154	Accessory Control Cable, RCA to mini-phono, 6 ft, for use with D3, D1 and MiniCam Video Cameras for remote connection with Video Printers (Smith & Nephew REF 7207801, 7207812 and 7206094), Video Cassette Recorder (REF 7205010) and Smith & Nephew 600-series Image Management System
4175	RGB Cable, 6 ft (1.8 m)
⚙ 4174	RGB Cable, 25 ft (7.6 m)
⚙ 7210114	RGB Cable with single connector for flat panel displays, 6 ft (1.8 m).
⚙ 7204585	DB9 to DB25 RS232 Data Cable, for use with Smith & Nephew Digital Camera Control Unit and Video Print Recorders (REF 7204253, 4259, 4238, 4251)
72201420	SDI/HDTV Cable, RG-59, BNC, 10'
72201438	SDI/HDTV Cable, RG-59, BNC, 25'
⚙ 7209709	High-Grade S-VHS (S-video) Cable, 1.5 ft (46 cm)
7204580	High-Grade S-VHS (S-video) Cable, 6 ft (1.8 m)
⚙ 7204582	High-Grade S-VHS (S-video) Cable, 15 ft (4.5 m)
7204583	High-Grade S-VHS (S-video) Cable, 25 ft (7.6 m)
⚙ 7204584	High-Grade S-VHS (S-video) Cable, 50 ft (15.2 m)
⚙ 7205002	DB9-RCA Remote Cable
⚙ 7204586	RCA to Mini Cable
⚙ 7209761	S-USB Cable, 50 ft (15.2 m)
⚙ 7209762	S-USB Cable, 75 ft (22.8 m)
⚙ 7209775	S-USB Cable, 3 ft (.92 m)
⚙ 7209836	S-USB Cable, 10 ft (3 m)
⚙ 7209848	Audio Hook-Up Cable, 1/8" phono to 1/8" phono, 50 ft (15.2 m)
⚙ 7209849	Audio Hook-Up Cable, 1/8" phono to 1/8" phono, 75 ft (22.8 m)
⚙ 7209850	Audio Hook-Up Cable, 1/8" stereo phono to 1/8" stereo phono, 50 ft (15.2 m)
⚙ 7209851	Audio Hook-Up Cable, 1/8" stereo phono to 1/8" stereo phono, 75 ft (22.8 m)
⚙ 7209852	Audio Hook-Up Cable, 1/8" stereo phono male to 1/8" stereo phono female, 50 ft (15.2 m)
⚙ 7209853	Audio Hook-Up Cable, 1/8" stereo phono male to 1/8" stereo phono female, 75 ft (22.8 m)
⚙ 7209856	Audio Hook-Up Cable, 1/8" phono to 1/8" phono, 1.5 ft (46 cm)
⚙ 7210482	Cable Assembly, DVI-D 3 meter single line
⚙ 7210114	Cable, 6', DB15 Male to 4BNC
⚙ 7210481	Adapter, DVI Analog Port to VGA Cable
7210482	Cable, DVI-D, 3 m, single link
⚙ 7210483	Cable, SVGA Male to SVGA M, 10'
⚙ 7210484	Cable, DB9 Male to DB9 F-SER, 10'
⚙ 72200393	Cable, DVI-D, 15', Promedica

## Video Carts and Accessories



### Endoscopy Base Carts

Reference #	Description
72202161	Cross Specialty Cart with LCD Video Boom
72202162	Cross Specialty Cart with LCD Video Boom and Transformer
72202163	Cross Specialty Cart with LCD Post-mount
72202164	Cross Specialty Cart with LCD Post-mount and Transformer

### Isolation Transformer

Reference #	Description
72201096	Transformer Upgrade/Replacement Kit



## Notes

---

---

---

---

---

---

---

---

---

---

---

---

---

---

---

---

---

---

---

---

---

---

---

---

---

---

---

---

---



**500XL Xenon**  
Light Source



- Provides bright white light for natural color reproduction
- Features include a compatible, multi-port light cable receptacle

## Light Sources

### Xenon Light Source



500XL Light Source provides bright white light for natural color reproduction. Features include a multi-port light cable receptacle compatible with fiber optic light cables with Smith & Nephew/WOLF™, Olympus™, Storz™ or ACMI™ source ends.

#### 500XL Xenon Light Source, 300W

Reference #	Description
72200568*	Light Source, 500XL, Xenon
72200580	500XL System, US
72200581	500XL System, Spanish
72200582	500XL System, French
72200583	500XL System, German
72200584	500XL System, Italian
72200585	500XL System, Swedish
72200586	500XL System, Dutch
72200587	500XL System, UK
72200588	500XL System, International
72202381	500XL System, Portuguese
72202382	500XL System, Danish
72202383	500XL System, Norwegian
72202384	500XL System, Korean

#### Accessories

72200598	Kit
10600433	Manual
91001639	Null Modem Cable, male-to-male

\* Item shown

## Light Sources

### Light Source Replacement Parts

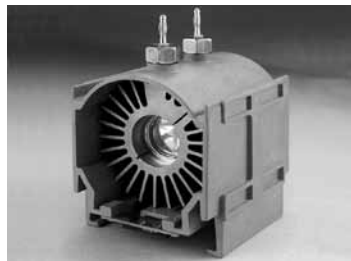

#### Replacement Lamps

Reference #	Description
72202439	Replacement Lamp Module, 500XL Xenon
7207398*	Replacement Xenon Lamp Module, 300W, for 300XL Xenon Light Source, 500-hour minimum life



72200529*	Replacement Xenon Lamp Module, 180W, for 420XL Light Source (72200510)
-----------	--



7205351	Replacement Xenon XL Lamp Module, 180W, for Xenon Light Source, 500-hour minimum life
---------	---

7204741*	Replacement Xenon Lamp Module, 100W, for Xenon Light Source, 500-hour minimum life
----------	--

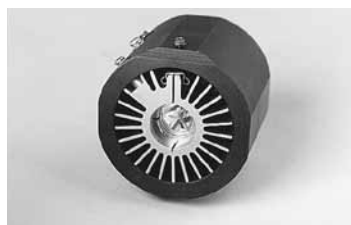

4248*	Replacement Xenon Lamp Assembly for DYOBRITE® 3000 Light Source (REF 4243)
-------	--

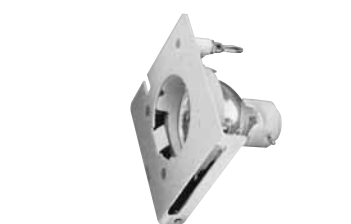

2974*	Replacement Metal Halide Arc Lamp with bracket, 250W for AutoBrite, ABI II or MicroBrite Illuminators, 250-hour life
-------	--

4550	Replacement Arc Lamp High-Voltage Cable Assembly for AutoBrite Illuminator II
------	---



7204563*	Replacement Lamp for DYOSITE II, 150 W, 100-hour life
----------	---



## Light Sources

### Fiber Optic Light Cables and Adaptors

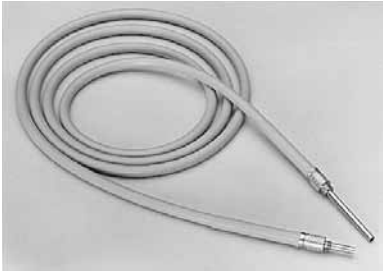

Gemini Universal 4 mm Fiber Optic Light Cables without Adaptor  
For use with Smith & Nephew 4 mm and 2.7 mm arthroscopes.

Reference #	Description
2985*	4.0 mm x 8 ft
7205180	4.0 mm x 10 ft
7205179	4.0 mm x 12 ft

Use only REF 2146 and REF 2147 Versitip Adaptors for connection to Smith & Nephew Light Sources and endoscopes.

Gemini Universal 5 mm Fiber Optic Light Cables without Adaptor  
For use with arthroscopes and laparoscopes.

Reference #	Description
2140	5.0 mm x 8 ft
7205178	5.0 mm x 10 ft
7205177	5.0 mm x 12 ft

Use only REF 2146 and REF 2147 Versitip Adaptors for connection to Smith & Nephew Light Sources and endoscopes.

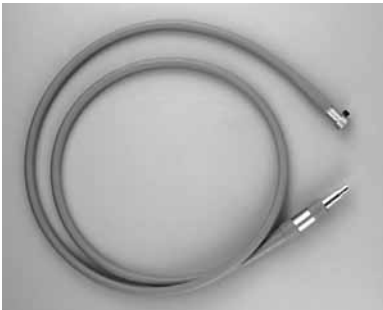

Gemini Universal Fiber Optic Light Cables with Adaptors

Reference #	Description
7208329*	6.0 mm x 10 ft, with permanently fixed Smith & Nephew/Wolf™ source and instrument end adaptors. For use with all 10 mm laparoscopes. Not for use with arthroscopes or 5.5 mm laparoscopes.



3004*	2.0 mm x 8ft, with Smith & Nephew/Wolf adaptors. For use with 1.9 mm arthroscopes
-------	---

## Light Sources

### Fiber Optic Light Cables and Adaptors

#### Versitip Adaptors – Instrument End

For Smith & Nephew Gemini Universal Fiber Optic Light Cables.

Reference #	Description
2141	ACMI Instrument ("AI") Versitip Adaptor for 4.0 mm and 5.0 mm light guides Intended to interface Smith & Nephew Gemini Universal Fiber Optic Light Cables with ACMI endoscopes.
2146	Smith & Nephew/Wolf™ Instrument ("WI") Versitip Adaptor Intended to interface Smith & Nephew Gemini Universal Fiber Optic Light Cables with Wolf and Smith & Nephew endoscopes.
2143	Storz™/Olympus™ Instrument ("SI") Versitip Adaptor Intended to interface Smith & Nephew Gemini Universal Fiber Optic Light Cables with Storz or Olympus endoscopes.

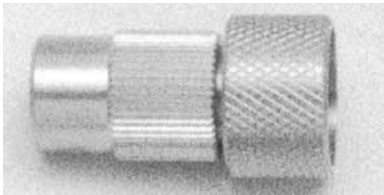
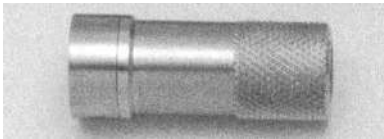
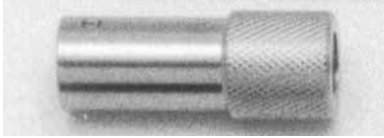

#### Versitip Adaptors – Light Source End

For Smith & Nephew Gemini Universal Fiber Optic Light Cables.

Reference #	Description
2142	ACMI Source ("AS") Versitip Adaptor Intended to interface Smith & Nephew Gemini Universal Fiber Optic Light Cables with ACMI Light Sources.
2147	Smith & Nephew/Wolf Source ("WS") Versitip Adaptor Intended to interface Smith & Nephew Gemini Universal Fiber Optic Light Cable with Smith & Nephew or Wolf light sources.
2145	Olympus Source ("OS") Versitip Adaptor Intended to interface Smith & Nephew Gemini Universal Fiber Optic Light Cable with Olympus light sources.
2144	Storz Source ("SS") Versitip Adaptor Intended to interface Smith & Nephew Gemini Universal Fiber Optic Light Cable with Storz light sources. For use with Smith & Nephew 420XL Light Source.



## Light Sources Compatibility Matrix

To connect a Smith & Nephew light guide to a Smith & Nephew light source:

Smith & Nephew Light Guide	Smith & Nephew Versitip Adaptor Light Source End	Light Source Vendor	Connect to Light Source Input Port Labeled:
7208329	NONE	Smith & Nephew	Smith & Nephew/Wolf™
3004	2147	↓	↓
2985	↓	↓	↓
7205180	↓	↓	↓
7205178	↓	↓	↓
7205179	↓	↓	↓
7205177	↓	↓	↓

To connect a Smith & Nephew light guide to another vendor's light source:\*

Any of the following Smith & Nephew Light Guides		Light Source Vendor	Smith & Nephew Versitip Adaptor Light Source End
2985		ACMI TM	2142
2140		Wolf	2417
7205180		OlympusTM	2415
7205178		StorzTM	2144
7205179			
7205177			

To connect another vendor's light guide to a Smith & Nephew light source:\*

Light Guide Vendor	Smith & Nephew Versitip Adaptor Light Source End	Light Source Vendor	Connect to Light Source Input labeled:
ACMI	NONE	Smith & Nephew	ACMI
Wolf	Insert corresponding receptacle on front panel labeled with vendor's name	↓	Smith & Nephew/Wolf
Olympus			Olympus
Storz			Storz

\* It is recommended that only Smith & Nephew light guides are used with Smith & Nephew light sources. Other compatibility is not guaranteed and may negatively impact the performance of the Smith & Nephew device.



Sterilization Trays



- Solid and durable construction

## Storage and Sterilization Trays

### For Handheld Instruments

Reference #	Description
011673	Linear Instrument Sterilization Tray, holds 15 instruments (10"L x 9"W x 4.5"H)

NOTE: Sterilization Trays only sold as a unit. Top and bottom not available separately.

### For Cruciate Reconstruction

Reference #	Description
011802	TRE-CORE Bone Cutting Guide System (18"L x 8"W x 2"H)
014870	ACL REDUX Revision System (21"L x 10"W x 2"H)
7207182	GRAFTMASTER® II Graft Preparation System (18"L x 8"W x 2.5"H)
7207357	Large Sterilization Tray for Smith & Nephew ACUFEX® Director PCL Drill Guide System, large (14"L x 9"W x 1.5"H)

### For Meniscal Repair

Reference #	Description
011702	Meniscal Stitcher (10.37"L x 8"W x 1"H)
7207357	Large Sterilization Tray with mat (13"L x 8"W x 1.25"H) for use with the Meniscus Mender II System

### For Fixation Systems

Reference #	Description
011804	Fixation Post Instrument System (9"L x 9"W x 1.5"H)
7205514	SOFTSILK® 1.5 Screw System (15"L x 10"W x 2"H)
7207196	SOFTSILK 2.0 Screw System (14"L x 9"W x 1.5"H)
7207169	RCI Screw System
7207369	Medium Sterilization Tray with mat (10.5"L x 6.5"W x 1.5"H)

### For Osteochondral Grafting

Reference #	Description
7205507	MOSAICPLASTY Complete System (19"L x 9"W x 2"H)
7205604	MOSAICPLASTY Precision System (19"L x 9"W x 2"H)

## Storage and Sterilization Trays

### For Shoulder Reconstruction

Reference #	Description
7209182	ARTHRO-PIERCE® Sterilization Tray (13"L x 9"W x 6"H)

### For Extremities

Reference #	Description
7207032	Guhl System Non-invasive Ankle Distractor (18.5"L x 8.5"W x 2"H)
7207019	Small Joint Arthroscopy System
7207935	Sterilization tray, holds up to eight Micro Instruments plus probe
7207696	Trigger Finger Sterilization Tray (9"L x 10"W x 3"H)
4450	ECTRA® II System Hand Holder and Sterilization Tray with cover

### For Hip Arthroscopy

Reference #	Description
7207934	Hip Arthroscopy Sterilization Tray

### For Operative Hysteroscope Set

Reference #	Description
7205683	Autoclavable Storage and Sterilization Tray (20"L x 9W" x 2"H) Includes: Silicone mats, cover, 12 posts, 12 tie-downs and post removal tool

---

## Storage and Sterilization Trays



### Miscellaneous

Reference #	Description
011703	Small Sterilization Tray with mat (9.25"L x 3"W x 1.5"H)
7207369	Medium Sterilization Tray with mat (10.5"L x 6.5"W x 1.5"H)
7207357	Large Sterilization Tray with mat (13"L x 8"W x 1.25"H)
7205683	Autoclavable Storage and Sterilization Tray (20"L x 9"W x 2"H) Includes: Silicone mats, cover, 12 posts, 12 tie-downs and post removal tool
8104237	Replacement rubber mat for Sterilization Tray REF 7207357
72202428	Multi-Purpose Sterilization Tray

### For Endoscopes, Cameras Autoclavable Not for use with Sterrad™ sterilizers.

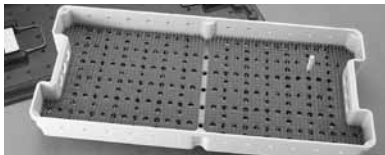

Reference #	Description
7205683*	Autoclavable Storage and Sterilization Tray (20"L x 9"W x 2"H) Includes: Silicone mats, cover, 12 posts, 12 tie-downs and post removal tool

7205703 Replacement parts for REF 7205683 Sterilization Tray (shown above). Includes 12 posts, 12 tie-downs and 1 post removal tool



7208209\* Multi-purpose Sterilization Tray (18"L x 2.5"W x 1.5"H), holds one rigid endoscope from 1.0 mm to 10 mm in diameter and up to 320 mm in length



7204737\* Autoclavable Arthroscope Sterilization Tray (9.5"L x 3"W x 1.25"H), holds two Direct-View Autoclavable Arthroscopes

### For Shavers and Blades

Reference #	Description
7205683	Autoclavable Storage and Sterilization Tray (20"L x 9"W x 2"H) Includes: Silicone mats, cover, 12 posts, 12 tie-downs and post removal tool

\* Item shown



## Miscellaneous

### Personal Protection Items



#### CLOUD 9 Absorption Mat

The CLOUD 9 Absorption Mat is cost-effective because it reduces cleanup time. Captured fluids and debris are contained by folding up the corners of the mat.

Reference #	Description
-------------	-------------

7209461	CLOUD 9 Roll (40" x 200'), 2 rolls per package 40 x 100 each
7209462	CLOUD 9 Roll (25 disposable single sheets, each 40" x 5 1/2')



#### Face Shields

These lightweight disposable face shield have a foam headband that contains air vents to reduce fog and condensation. The durable 7 mil, anti-fog shield provides eye protection without sacrificing vision.

Reference #	Description
-------------	-------------

7209463	Disposable Full Face Shield (complete face protection), 50 per box
7209464	Disposable Half Face Shield (upper face protection), 50 per box



#### Fluid Barrier Boots

These durable, disposable, 6-gauge polyvinyl fluid barrier boots have been proven effective with the Bacteriophage Penetration Test. Boot seams are heat-sealed and soles are a continuous vinyl barrier to prevent tearing and leaks.

Reference #	Description
-------------	-------------

7209470	Disposable Knee-High Fluid Barrier Boots, 50 pairs per box Small: men up to size 7, women up to size 9
7209469	Disposable Knee-High Fluid Barrier Boots, 50 pairs per box Medium: men sizes 8-12, women sizes 9+
7209468	Disposable Knee-High Fluid Barrier Boots, 50 pairs per box Large: men sizes 12+

## Miscellaneous

### Fracture Support Table

Fracture Support Table

Provides leg support for tibial-fracture repair procedures

Reference #	Description
7210566	Fracture Support Table with gel pad
7210567	Fracture Support Table replacement pad
7210568	Table stabilization straps



## Laparoscopes

R



- Stainless steel construction to withstand sterilization modalities
- Sapphire distal lenses and rear ocular windows for improved scratch resistance

## Laparoscopes



Light post opposite direction of view

### Direct-View Autoclavable Laparoscopes

- Stainless steel construction to withstand sterilization modalities (autoclave, EtO and Sterrad™)
- Fully autoclavable, with both distal and proximal ends uniquely soldered for longevity
- Autoclavable laparoscopes have sapphire distal lenses and rear ocular windows for much greater scratch resistance than conventional glass
- Indications include thoracic surgeries

REF	Outer Diameter	Direction of View	Field of View	Working Length	Recommended Light Cable
72202463	10 mm	0	81°	330 mm	5.0 mm
72202464	10 mm	30	81°	330 mm	5.0 mm
72202465	10 mm	45	81°	330 mm	5.0 mm
72202110	5.5 mm	0°	84°	290 mm	5.0 mm
72202111	5.5 mm	30°	84°	290 mm	5.0 mm
72202112	5.5 mm	45°	84°	290 mm	5.0 mm

## Laparoscopes and Accessories

### Direct-View Autoclavable Bariatric Laparoscopes

- Stainless steel construction to withstand sterilization modalities (autoclave, EtO and Sterrad™)
- Fully autoclavable, with both distal and proximal ends uniquely soldered for longevity
- Autoclavable laparoscopes have sapphire distal lenses and rear ocular windows for much greater scratch resistance than conventional glass
- Indications include bariatric surgeries

REF	Outer Diameter	Direction of View	Field of View	Working Length	Recommended Light Cable
7211077	10 mm	30°	84°	450 mm	6.0 mm
7211078	10 mm	0°	84°	450 mm	6.0 mm
7211079	10 mm	45°	84°	450 mm	6.0 mm
⚙️ 7208328Z <sup>†</sup>	5.0 mm	30°	84°	290 mm	4.0 mm

### MicroLaparoscopes

- Stainless steel construction to withstand sterilization modalities (EtO and Sterrad)
- Indications include general and gynecological laparoscopic procedures

REF	Outer Diameter	Direction of View	Field of View	Working Length	Recommended Light Cable
⚙️ 7208334Z	3.0 mm	0°	80°	277 mm	4.0 mm

### Accessories for Autoclavable Endoscopes

Reference #	Description
7205548	Aluminum oxide vial for cleaning autoclavable endoscope lenses
7210721	Protective cap for autoclavable scopes. Fits 4.0 mm and 5.5 mm scopes. (70 per package)

### Direct-View Operative Laparoscope Accessories

Reference #	Description
7205561	Replacement Seal Caps (5 per box)

## Hysteroscopes, Cystourethrosopes and Hysteroscopic Sheaths



Direct-View Autoclavable Hysteroscopes/Cystourethrosopes\*

Light post opposite direction of view. Stainless steel construction to withstand sterilization modalities (Autoclave, EtO and Sterrad™)

REF	Outer Diameter	Direction of View	Field of View	Working Length	Sheath Style	Recommended Light Cable
7205463	4.0 mm	0°	101°	300 mm	Storz™	4.0 mm
7205465	4.0 mm	30°	101°	300 mm	Storz	4.0 mm
7205462	4.0 mm	70°	101°	300 mm	Storz	4.0 mm

\* Indications for Use: Hysteroscopes and accessories (Operative Hysteroscopic Sheath) are used to permit viewing of the cervical canal and the uterine cavity for the purpose of performing diagnostic and surgical procedures. Cystourethrosopes are indicated for use in the examination of the bladder, urethra, and distal ureter, and, using additional accessories, to perform various diagnostic and therapeutic procedures.



### Hysteroscopic Sheaths

Reference #	Description
4512	5.0 mm Diagnostic Hysteroscopic Sheath, 15 Fr, single stopcock
7204513	7.0 mm Operative Hysteroscopic Sheath, 21 Fr, with one 2.9 mm working channel, double stopcocks



## 400 Insufflator

### Smith & Nephew 400 Insufflator

The Smith & Nephew 400 Insufflator is the only insufflator with TAP, which delivers warmed CO<sub>2</sub> gas during laparoscopic surgery without an external control unit. Warmed gas is delivered through a unique inline mechanism in close proximity to the patient for maximum effectiveness.

Additional safety feature prevents inadvertent changes in gas flow rate and abdominal pressure during the procedure.

- In-line insufflator gas warming capability is provided through one or two parts.
- A stop safety feature prevents intra-abdominal pressure from exceeding 15 mmHg.
- A TAP feature acts as an independent abdominal pressure monitoring line.
- Simple front panel design is arranged in three distinct sections: one for gas supply, one for gas flow rate control and one for abdominal pressure regulation.



Reference #	Description
7209932	400 Insufflator System, US
7209934	400 Insufflator System, UK
7209936	400 Insufflator System, German
7209938	400 Insufflator System, Spanish
7209940	400 Insufflator System, French
7209942	400 Insufflator System, Italian

### 400 Accessories

Reference #	Description
7209944	In-line Gas Warmer, 8 pin
7205861	400 Insufflator System Tubing, disposable (10 per box)
7205836	TAP Tubing Set, disposable (10 per box)
4270	High Pressure Hose/Clamp for connecting extra CO <sub>2</sub> source
7205972	DISS Connector with 6 ft Hose
7205868	Warmer for 40L insufflator (4 pins)

### 400 Insufflator Disposables

Reference #	Description
7205861	Insufflation Tubing, disposable (10 kits per box)
7205836	TAP Tubing Set, disposable (10 kits per box)
7205363	Tubing for 7205362 15 L unit. Unit is non-sellable, non-repairable, non-exchangeable

NOTE: Used with units 7205835 (20L) and 7205832 (40L)



## INTERCEPTRE Modular Instruments

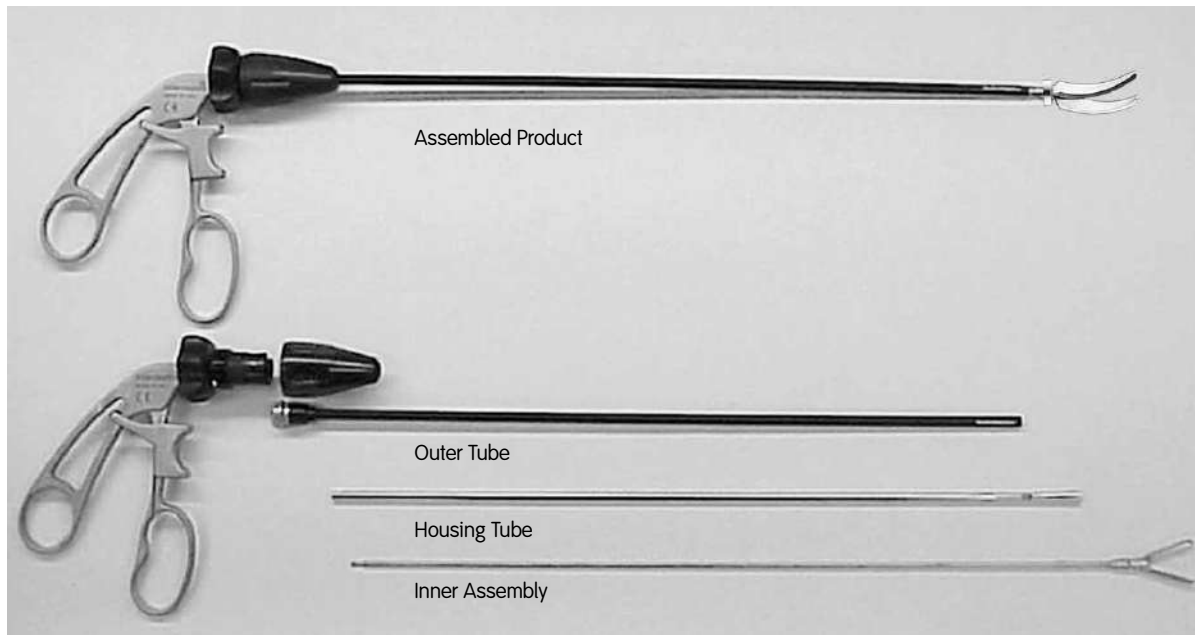

### INTERCEPTRE Laparoscopic Instruments

INTERCEPTRE laparoscopic instruments offer the combination of the strength and precision of one-piece instruments with a convenient modular design that facilitates cleaning and economy of purchase – instruments can be ordered complete or in parts for total flexibility.

- All instruments are 330 mm working length
- Complete instrument consists of one each: Handle, Housing Tube, Inner Assembly, Outer Tube and Nose Cap
- Modular design
- Ergonomic handle
- Permanently sharp, economical scissors ensured by replaceable scissors tips
- Pinless hinge gives exceptional holding power and strength
- Instruments can be ordered complete or in parts for total flexibility of purchase



Handle with Electro-surgical Post



Handle (locking)



5.0 mm Nose Cap

## INTERCEPTRE Modular Instruments



### Scissors – INTERCEPTRE

Low distal insulation for increased safety in an electrosurgical environment; handle features electrosurgical post; always sharp and economical; easy-to-replace blades with a “No Thread” mechanism that ensures they cannot detach during surgery.

Reference #	Description
-------------	-------------

7208298	Curved Metzenbaum – Assembled Product
---------	---------------------------------------

7208302	Handle with Electrosurgical Post
---------	----------------------------------

7208305	Outer Tube
---------	------------

7209540	Scissors Blade
---------	----------------

7209712	Housing Tube
---------	--------------

7209777	5.0 mm Nose Cap
---------	-----------------

7208299	Straight Metzenbaum – Assembled Product
---------	---

7209541	Scissors Blade
---------	----------------

7208300	Hook – Assembled Product
---------	--------------------------

7209542	Scissors Blade
---------	----------------



## Laparoscopic Instruments



- All dissecting instruments can be rotated 360°
- All are fully insulated and have monopolar electrosurgical capabilities
- Laparoscopic instruments that utilize the tried and tested ACUFEX® pinless hinge design offer superior reliability and strength. The high quality of this design has been proven with over 14 years experience in manufacturing arthroscopic instruments.

### Dissectors

5.0 mm diameter, 330 mm working length.

Reference #	Description
-------------	-------------



7205617	Maryland
---------	----------



7205619	Fine Tip
---------	----------



7205616	Curved Crile
---------	--------------



7205615	Straight Crile
---------	----------------



7205614	Meeker
---------	--------



7205620	Olive Tip
---------	-----------



7205618	Dolphin Nose
---------	--------------

## Laparoscopic Instruments



- All graspers have a ratcheted locking mechanism
- Dual action graspers can be rotated through 360°
- Insulated shaft for additional safety in an electrosurgical environment

### Graspers

5.0 mm diameter, 330 mm working length.

Reference #	Description
-------------	-------------



7205609	Single Action Atraumatic
---------	--------------------------



7205611	Single Action Retraction Forceps
---------	----------------------------------



7205610	Dual Action Atraumatic (rotatable)
---------	------------------------------------



7205612	Dual Action Retraction Forceps (rotatable)
---------	--



Global Services



- 98% of issues resolved within 24 hours
- 35 years of service experience
- Proprietary parts and knowledge



# Sales and Service Policies

## Prices

Due to our continuing product improvement, Smith & Nephew reserves the right to change product prices and to discontinue product without prior notice.

## Taxes Outside the US

The amount of any applicable sales, use, excise or other municipal, state, or federal taxes will be billed and collected by the selling company.

## Taxes in the US

The amount of any applicable sales, use, excise, or other municipal, state, or federal taxes will be billed and collected by Smith & Nephew unless the customer possesses and provides an exemption certificate.

## Terms of Payment

For sales to customers residing in the US, the terms are net 30 days from date of invoice. Outside the US, please refer to terms defined by your Smith & Nephew Representative.

## Delivery Outside the US

Unless otherwise specified, we reserve the right to make partial shipments and invoice them accordingly. Contact your Smith & Nephew Customer Service Representative for specific delivery information in your country.

## Delivery in the US

Shipment methods are at Smith & Nephew's discretion and all deliveries are F.O.B., Andover and Mansfield, Massachusetts, or Oklahoma City, Oklahoma, unless otherwise stated.

Standing orders can be arranged upon request. Please identify the product and quantity to be delivered to your facility on a weekly or monthly basis.

Next day delivery is available on all product requests received by 6 pm EST. Contact Smith & Nephew Customer Service for availability.

In certain areas special arrangements can be made, if required, for product delivery by 8 am local time.

## Product Availability

Not all products listed in this catalog are available in all countries. Contact your local Smith & Nephew representative.

## Warranty

Smith & Nephew products are guaranteed to be free from defects in material and workmanship for the warranty period for a particular product, beginning from date of invoice. This warranty is restricted to repair or replacement by Smith & Nephew, at its option, of any product found to be defective during the warranty period. Damage inflicted to a product by the user will result in additional charges and may void the warranty. This includes, but is not limited to, normal use-related damage, any attempted repairs by unauthorized service providers, using a sterilization method not approved by Smith & Nephew, and using the product in a way that is not intended by Smith & Nephew. All warranties apply to the original buyer only and are not transferable. In no event shall Smith & Nephew be liable for any anticipated profits, consequential damages, or loss of time incurred by the buyer with the purchase or use of any product.

## ⚙️ Made to Order (MTO) Instruments

We will accept orders for Made To Order (MTO) instruments. All Made To Order (MTO) sales are final and production lead time may vary depending on the product. Service agreements and service exchange is not available on MTO or custom products. These products are serviced on a repair only basis.

## Minimum Order

Smith & Nephew products are offered exclusively through authorized representatives. For the name and address of your local representative, contact our Customer Service Department. Sales personnel may not alter the above terms, extend credit, or accept payment for merchandise.

## Customer Service Phone

+1 800 343 5717 (Available 8 am – 6 pm EST),

## Customer Service Fax

+1 800 554 6105

Option 1: Orders, Option 2: Technical Support,  
Option 3: Returns, Repairs, Service Exchanges,  
Option 9: Emergency Technical Assistance

## Smith & Nephew, Inc.

Advanced Surgical Devices Division  
150 Minuteman Road  
Andover, Massachusetts 01810, USA

## Trademarks

All trademarks acknowledged. The following are trademarks of Smith & Nephew:

ABLATOR°	MINITAC°
ACCU-PASS°	MINI-TAG°
ACUFEX°	NOTCHBLASTER°
ACUFEX DUCKBILL°	NOTCHMASTER°
ARTHROGARDE°	ORBIT°
ARTHROPAC°	OSTEORAPTOR°
ARTHRO-PIERCE°	OVERBITER°
BICEPTOR°	PITBULL°
BIORAPTOR°	POWERMINI°
BIORCI°	QUICK-T°
BIOSURE°	RAP-PAC°
BONECUTTER°	RAPTOR°
CANNU-FLEX°	SAPHYRE°
CLEAR-TRAC°	SCULPTOR°
CLEAR-TRAC° COMPLETE	SOFTSILK°
CROSSTRAC°	STINGRAY°
DUCKBILL°	STONECUTTER°
DUCKLING°	SURETAC°
DURABRAID°	SURILLIUM°
DYOBRITE°	SYNOVATOR°
DYONICS°	T-FIX°
DYONICS° POWER°	TRAILBLAZER°
DYOVAC°	TRUCLEAR°
ECTRA°	TRUFIT°
EFLEX°	TRUGRAFT°
ELECTROBLADE°	TRUKOR°
ENDOBUTTON°	TRUREPAIR°
ENDO-FIX°	TUNDRA°
EP-I°	TURBOCUTTER°
FAST-FIX°	TURBOWHISKER°
GLIDER°	TWINFIX°
GRAFTMASTER°	ULTRABRAID°
HEDGEHOG°	VULCAN°
HEALICORE°	VECTOR°
HELICUT°	
INCISOR°	
INCISOR° PLUS	
KINSA°	
LIGAMENT CHISEL°	
MICRO VECTOR°	

---



## Patents

These products are covered by one or more of the following patents:

**US Patent No.** 5,270,622; 5,277,696; 5,290,282; 5,306,301; 5,312,438; 5,318,582;  
5,320,635; 5,324,301; 5,325,883; 5,346,503; 5,356,419; 5,364,400; 5,366,477; 5,374,269;  
5,380,334; 5,383,878; 5,400,805; 5,417,691; 5,423,819; 5,423,860; 5,437,675; 5,443,468;  
5,454,811; 5,456,685; 5,458,596; 5,464,425; 5,496,326; 5,505,736; 5,510,070; 5,514,130;  
5,522,843; 5,522,844; 5,549,676; 5,563,481; 5,569,242; 5,569,303; 5,571,195; 5,575,757;  
5,590,570; 5,593,416; 5,601,558; 5,601,583; 5,602,449; 5,618,293; 5,620,415; 5,620,447;  
5,621,830; 5,628,766; 5,630,798; 5,630,799; 5,630,826; 5,643,203; 5,643,302; 5,643,303;  
5,645,588; 5,653,716; 5,662,611; 5,667,513; 5,672,945; 5,681,314; 5,687,742; 5,688,276;  
5,690,659; 5,690,676; 5,690,678; 5,693,060; 5,695,522; 5,702,401; 5,712,543; 5,718,706;  
5,720,766; 5,727,428; 5,728,100; 5,730,747; 5,740,801; 5,741,281; 5,743,914; 5,745,647;  
5,749,885; 5,755,731; 5,759,189; 5,769,894; 5,782,834; 5,782,924; 5,785,705; 5,792,182;  
5,797,836; 5,804,936; 5,808,813; 5,817,095; 5,823,994; 5,833,692; 5,840,060; 5,842,477;  
5,864,359; 5,871,493; 5,873,884; 5,882,339; 5,893,858; 5,893,874; 5,897,560; 5,899,907;  
5,902,741; 5,906,577; 5,908,426; 5,913,867; 5,919,702; 5,921,956; 5,928,240; 5,928,945;  
5,931,844; 5,935,149; 5,947,982; 5,947,990; 5,954,716; 5,957,836; 5,957,953; 5,961,521;  
5,961,535; 5,964,696; 5,964,777; 5,968,050; 5,976,127; 5,980,504; 5,986,271; 5,989,247;  
6,004,320; 6,007,533; 6,007,561; 6,007,570; 6,022,356; 6,030,400; 6,036,695; 6,042,573;  
6,045,561; 6,048,354; 6,051,006; 6,056,752; 6,060,306; 6,068,604; 6,068,628; 6,073,051;  
6,086,591; 6,086,592; 6,086,608; 6,090,122; 6,095,149; 6,099,514; 6,102,934; 6,117,161;  
6,120,541; 6,121,042; 6,122,549; 6,123,710; 6,126,682; 6,129,661; 6,132,442; 6,135,999;  
6,139,583; 6,146,385; 6,146,406; 6,149,654; 6,162,217; 6,168,593; 6,176,857; 6,187,011;  
6,200,329; 6,214,001; 6,221,107; 6,231,606; 6,235,057; 6,246,913; 6,258,086; 6,261,311;  
6,283,960; 6,290,715; 6,295,082; 6,328,752; 6,336,940; 6,350,262; 6,352,544; 6,355,053;  
6,358,253; 6,358,273; 6,375,658; 6,379,350; 6,387,110; 6,436,116; 6,440,141; 6,443,963;  
6,450,992; 6,451,030; 6,461,353; 6,461,357; 6,482,204; 6,482,210; 6,511,488; 6,517,568;  
6,533,802; 6,537,278; 6,544,260; 6,547,810; 6,551,279; 6,583,232; 6,599,289; 6,620,185;  
6,623,492; 6,638,276; 6,689,153

## Returned Goods Policy

### Outside the US

Please contact your local authorized Smith & Nephew representative.

### In the US

This policy supports all transactions that occur within the United States. Smith & Nephew will repair or replace, at its discretion, products that have not been obsoleted, discontinued or found to have manufacturing or material defects within the warranty period. Customers will be billed for misuse and abuse. Warranties apply only to the original buyer.

### Outside the US

Please contact your local authorized Smith & Nephew representative.

### In the US

This policy supports all transactions that occur within the United States. Smith & Nephew will repair or replace, at its discretion, products that have not been obsoleted, discontinued or found to have manufacturing or material defects within the warranty period. Customers will be billed for misuse and abuse. Warranties apply only to the original buyer.

Reason	Warranty Expiration Date	Packaging Requirements	Restocking Fee	Customer Freight Charge In/Out
Ordered incorrectly Overstocked product	30 Days	Original	No	Yes/Yes
Ordered incorrectly Overstocked product	31-60 Days	Original	Yes	Yes/Yes
Warranty of product repaired or exchanged within original warranty	Product Line	N/A	No	Yes/No
Warranty of product repaired or exchanged after original warranty	90 Days	N/A	No	Yes/No
Incorrect product shipped from Smith & Nephew	30 Days	Original	No	No/No
Program incentive	Program	N/A	No	Program
New product failures	30 Days	Original	No	No/Noes

### Conditions

- The warranty period begins on the equipment shipment date.
- Requests for credit returns must be received within 60 days of invoice date.
- A Return Authorization Number (R.A. Number) is required to return product. Smith & Nephew will issue the
  - R.A. Number
- Restocking fee is 20% of product value invoiced.
- Credit cannot be given for items damaged in return shipment due to inadequate packaging.
- Customers will be billed for non-returns after 30 days of shipped replacement product.
- To receive full credit, all products must be returned in full package quantities.
- 90 day warranty on repairs only applies to the defective component repaired.

## Global Services

For the highest quality service and proven performance, choose Smith & Nephew's Global Services. As an FDA inspected, ISO 9001 certified manufacturer, only Smith & Nephew has the proprietary parts and knowledge to maintain your equipment to the original factory condition. Smith & Nephew has 35 years of service experience, processing over 60,000 equipment repairs and 50,000 technical support calls each year. In fact, over 98% of all issues are resolved within 24 hours. Maximize the performance and life of your equipment by using Smith & Nephew Global Services.

### Global Services Benefits

#### **Responsiveness and uptime**

Issues resolved within 24 hours with technical phone support, on-site service and factory based service.

#### **Flexibility**

Offers a full range of services to meet your needs; from 24 hour service exchange to dedicated on-site service.

#### **Ease of administration**

Provides one number to call and comprehensive service agreements to minimize your administrative complexity and paperwork.

#### **Clinical performance**

Keeps your equipment in like-new condition helping you deliver better patient care.

#### **Cost savings**

Provides "Wear and Tear" protection and the highest quality service. This minimizes repeat repairs and results in real cost savings.

### US Programs

- Replacement Plan
- Service Exchange
- Repair
- On-site Services
- ACUFEX<sup>®</sup> Edge Express



\* Check with your sales representative for local availability

## Factory Service

Smith & Nephew expertly services your equipment at our FDA inspected, ISO 9001 certified facilities. The following are “return to factory” based services ranging from service agreements to per-incident service. Please contact your Smith & Nephew sales representative for more information. Some countries may not offer these programs. Factory-based services utilize the Return Authorization (RA) process. See page viii for details.

## Replacement Plan

The Replacement Plan is a service agreement that provides product replacement coverage for up to four years at a fixed price. Features include:

- Products are exchanged within 24 hours during normal business hours
- Coverage includes “Wear and Tear” protection. This covers use-related damage (e.g. front-end of scope is clipped)
- Available on new and existing products
- One purchase order provides coverage for an extended period of time
- Invoices can be monthly, quarterly or annual
- Software updates

### Conditions

Standard terms and conditions for the Service Agreements apply. Products to be covered must be in good working condition and not previously repaired by a non-authorized third party. Products are subject to inspection prior to coverage being extended. For a quotation in the U.S., please contact your Smith & Nephew sales representative.

## Service Exchange

This service provides product replacement on a per-incident basis. Features include:

- Products are exchanged within 24 hours during normal business hours
- Fixed price per exchange event

## Repair

This per-incident service is for customized products not available for service exchange.

Features include:

- Expert evaluation and quotation. (Declined quotations will be assessed a nominal evaluation fee)
  - Repairs done within 72 hours after your quote approval
-

---

## On-site Service

### On-site Service

Factory trained Smith & Nephew technicians provide maintenance and value-added services at your facility. Please contact your Smith & Nephew sales representative for more information and availability. Some locations may not offer these programs.

### ACUFEX<sup>®</sup> Edge Express

ACUFEX Edge Express is a fast, easy and convenient way to keep your ACUFEX Handheld Instruments in pristine condition. All repairs and services are performed by highly skilled craftsmen who have been comprehensively trained on precision equipment to restore ACUFEX instrumentation to Smith & Nephew's demanding quality specifications.

#### **Direct Benefits**

- Outstanding sharpness - edges are honed to factory specifications providing surgical teams with exceptional clinical performance
- Fast turn-around - repairs and sharpening are completed and delivered in days, not weeks
- Increased life and reduced capital expense - regular and proper maintenance means instruments will last longer and may result in fewer capital purchases
- Administrative ease - free shipping of service-related sharpening and loaner kits and fixed monthly payments

## Service Program Notes

### Eligibility

The following items are not eligible for Repair: Any consumable or disposable products such as light guides, lamps, cords, batteries, blades, tube sets and RF probes.

In addition to the above items, the following items are not eligible for Service Exchange or Replacement Plan: Made to Order or custom products, products beyond their designated service life, ACUFEX<sup>®</sup> instruments, cannulas, obturators, trocars, products serviced by unauthorized third parties, products sterilized by a method not approved by Smith & Nephew, or products used in a way not intended by Smith & Nephew.

### Return Authorization Process

This process is used for all service exchanges and repairs. To initiate this process in the US, call +1 800 343 5717. Press option 3 for Returns, Repairs and Service Exchanges and provide the following information. For next day service exchange, your call must be made before 3pm EST.

1. *Your Smith & Nephew customer number*
2. *Purchase order number*
3. *Model and serial number*
4. *Fax and phone number*

Smith & Nephew will issue a Return Authorization Number (RA#). To ensure proper receipt of your defective unit, please include correspondence identifying the problem, the RA# and clearly mark the shipping container with the RA#. Include your decontamination certificate. Ship to the appropriate Service Center as instructed (or listed on page **XX**). If this is a Service Exchange, and the defective unit is not received within 30 days, an invoice will be issued for the difference between the list price of a new unit and the service replacement price.

### Serial Numbers

Service agreements require valid serial numbers to be supplied by customer before an agreement can be activated.

### Standard Warranty Versus Service Agreement

Standard warranty on products is for a limited time and covers only manufacturing defects. Coverage for “use-related” damage during and after standard warranty is available through a service agreement.

### Product End-of-Support

As technology evolves, all products reach a point in their lifecycle when they can no longer be serviced. For Smith & Nephew labeled products, our policy is to provide service exchange or onsite service for at least four years after the new product is no longer available for sale. After this four year period, products may reach the end-of-support and only be repaired on a reasonable effort, time and materials basis until key components are no longer available. Made to Order (MTO) products are not bound by this support life policy and can only be repaired on a time and materials basis. For more information on product end of support, please ask your local Smith & Nephew sales representative.

---

## Service Centers

Country	Phone Number	Service Center Address
Australia	+61 7 3846 7800	Smith & Nephew Surgical Pty. Ltd Service Centre 188 Vulture Street South Brisbane QLD 4101 Australia
Brazil	+5511 5586 3255	PCE-Pro Cirurgia Especializada Ltda. Rua Itapiru, 137 São Paulo, -SP - 04143-010 Brasil
Canada	+905 813 7770	Smith & Nephew Canada 6685 Millcreek Drive Mississauga, ON L5N 5M5
Germany	+49 746 2208317	Smith & Nephew GmbH Service Center Gaensaecker 27 D-78532 Tuttlingen Germany
Japan	+81 3 5403 8825	Smith & Nephew KK SHIBA PARK Bld.A-3F 2-4-1 Shiba-Koen MINATO-KU Tokyo 105-0011, Japan
UK	+44 1480 423240	Smith & Nephew Endoscopy House Cardinal Park Godmanchester, Huntingdon, PE29 2SN United Kingdom
US	+1 800 343 5717 +1 978 749 1000	Smith & Nephew, Inc 76 S Meridian Avenue Oklahoma City, OK 73107-6512

## New Product Warranty

The following warranty terms are in effect at time of catalog publication. Smith & Nephew reserves the right to modify any of the warranty terms below. For the latest warranty information, it is best to contact Smith & Nephew directly.

Description	New Product Warranty
CORDLESS INSTRUMENTS	1 Year
Battery	30 Days
SHAVER COMPONENTS	
DYONICS® POWER Control Unit (REF 7205841)	730 days US, 790 days International
DYONICS POWER II Motor Drive Unit (REF 72200783)	365 days US, 425 days International
DYONICS POWER Footswitches (REF 7205396)	730 days US, 790 days International
DYONICS POWER Footswitches (REF 7205399)	730 days US, 790 days International
DYONICS POWER II Footswitches (REF 72201092)	365 days US, 425 days International
DYONICS POWER Corded Drill and Saw MDUs	1 Year
DYONICS POWERMAX® ELITE (REF 72200616)	365 days US, 425 days International
DYONICS POWERMAX ELITE (REF 72200872)	
DYONICS POWERMAX Motor Drive	365 days US, 425 days International
POWERMINI® Shaver Handpiece (REF 72201500)	365 days US, 425 days International
POWERMINI (REF 72201503)	365 days US, 425 days International
DYONICS Mini-Motor (REF 7205357)	730 days US, 790 days International
VISUALIZATION Products	1 Year
COUPLERS	90 Days
Light Guides	90 Days
VERSITIPS	90 Days
INSUFFLATORS	1 Year
IN-LINE GAS WARMER/HUMIDIFIER	90 Days
ARTHROSCOPIC FLUID IRRIGATION SYSTEM	1 Year
VULCAN® GENERATOR and FOOTSWITCH	1 Year
ACUFEX® HAND INSTRUMENTS	Lifetime†
VIDEO MONITORS and PRINTERS	1 Year
HP PRINTERS	90 Days
CANNULAS, OBTURATORS and TROCARS	1 Year
INTERCEPTRE INSTRUMENTS	1 Year
STERILIZATION TRAYS and CARTS	1 Year
HDI200 AUTOCLAVABLE CAMERA SYSTEM	2 Year

1. Picks, Curettes, Osteotome, Rasps, Gauges, Elevators, Retractors, Knives and Probes – 90 Days
2. Drivers, Taps, Awls, Drills, Rooters, Dilators, Aimers, Bullets, Offsets and Guides – 90 Days

## Service Replacement and Repair Warranty

All service replacement and repairs have a 90 day limited warranty

### Notes

90 day warranty on repairs only applies to the defective component repaired. Product returned that is found to have been serviced by unauthorized service providers, sterilized using a method not approved by Smith & Nephew or used in a way that is not intended by Smith & Nephew incur additional costs, regardless of warranty or service agreement status.

### Attention

Use of reprocessed, single-use blades may permanently damage, impede performance or cause failure of your Arthroscopic Shaver System. Use of such products may render any warranties null and void.

† Warranted to be free from defects in material and workmanship for their lifetime against failure in normal use.



## International Contacts

Country	Telephone
Argentina	54-11-4554-8100
Australia	61-2-9857-3999
Australia Customer Service for New Zealand	61-2-9857-3800
Austria and Eastern Europe	43-1-707-9102
Belgium	32-2-702-2920
Brazil	55-11-5586-3255
Canada	1-877-977-1772/1-905-813-7770
Chile	56-2-341-7717
P. R. China	86-21-233-03000
Columbia	57-1-257-3535
Costa Rica	56-1-994-5209
Denmark	45-4580-6100
Finland	358-20-786-6300
France	33-243-832-464
Germany	49-40-70-700-200
Greece	30-210-991-3190
Hong Kong	852-2648-7700
India	91-22-4005-5090
Ireland	353-1890-763-636
Israel	972-3-923-3345
Italy	39-039-6094216
Japan	81-3-5403-8825
Korea	822-6001-7575
Malaysia	603-7958-7103
Mexico	52-55-5340-2200
Netherlands	31-206543999
New Zealand (Auckland)	64-9-820-2840
New Zealand (Christchurch)	64-3-389-4423
Norway	47-66-842020
Poland	48-22-570-30-76 or 48-22-570-3066
Portugal	35-1-214-460-650 or 35-1-214-466-055
Puerto Rico	1-787-764-5115
Russia	7-495-984-5503
Singapore	65-6270-0552 – also for Indonesia, Philippines, Vietnam, Brunei, and Sri Lanka
South Africa	27-31-242-8111
Spain	0034-9027-89876
Sweden	46-31-746-5800
Switzerland	41-41-766-3939
Thailand	662-719-6221
Turkey	90-212-284-6434 or 90-212-226-2526
U. A. E.	971-4-429-9111
United Kingdom	44-1480-423210
United States	1-800-749-1000
Venezuela	58-212-700-7900

## Financial Services

As a turnkey acquisition strategy for all Smith & Nephew products and services, we address the complexities that healthcare administrators face in today's market by offering the expertise to assist you in your effort to deliver the highest quality patient care in the most affordable way possible. Please call us for more information: 866-523-3278. Some countries may not offer these programs. Please contact your country representative.

### Financial Benefits

#### **Flexibility**

As your business grows and your needs change, you can add or upgrade at any point during the term through add-on schedules. You also have the option to include service contracts.

#### **Upgraded technology**

The healthcare industry demands that you have the latest technology, so a short-term operating lease can help you get the equipment and keep your cash. Your risk of getting caught with obsolete equipment is lower because you can upgrade or add equipment to meet your ever-changing needs.

#### **Flexible end-of-term options**

There are several options for disposing of equipment after the lease term ends, including returning the equipment, renewing the lease, or purchasing the equipment.

#### **100% financing**

Since a lease does not require a down payment, it is equivalent to 100% financing, which means you have more money to invest in revenue-generating activities.

#### **Customized solutions**

A variety of products are available, allowing you to tailor a program to fit your month-to-month or year-to-year cash flow needs. You are able to customize a program to address your needs and requirements, e.g., cash flow, budget, transaction structure, cyclical fluctuations.

### Financial Programs

#### **Cost-Per-Case Program**

A program where you pay for the equipment as you use it. The cost-per-case expense can be applied to your operating budget, thereby freeing up capital budget dollars.

#### **Cost-Per-Consumable Program**

A program that enables you to standardize your OR with all Smith & Nephew products. An upcharge that covers the equipment you wish to acquire is applied to your consumables.

#### **Fixed-Cost Financing Program**

A fixed cost for the equipment you wish to acquire is invoiced monthly for your desired term. The fixed cost may be treated as an operating expense, thereby freeing up capital budget dollars. Consult with your accounting professional for advice.

#### **Customized Program**

Smith & Nephew will design a program tailored to meet your specific needs:

- Operating Leases
  - Capital Leases
  - Deferred Payment Program
  - Step Up Lease Program
  - Seasonal Cash Flow Lease Program
-



0000		G-4	3632		D-14, M-2	4309		D-9, K-10
1080		N-1	3671		D-8, K-9, K-20	4310		D-9, K-10
1120		C-4	3672		D-8, D-9, K-9, K-20	4314		D-6
1131		C-4	3673		K-2, K-5	4317		D-9, K-10
1132		C-4	3679		B-12	4347		M-6
1140		C-4	3691		D-9, K-10	4355		K-11, K-20
1150		C-4	3692		D-9, K-10	4356		K-1, K-4, K-11
1177		A-39, N-3	3696		D-8, K-9	4359		K-12, K-20
1420		C-4	3701		H-3	4419		D-9, K-10, K-20
1900		C-4	3702		H-3	4428		G-4
1981		B-2	3703		H-3	4432		D-16, D-17, D-18, D-19
1986		K-5, K-6	3704		H-3	4433		D-16, D-17, D-18, D-19
1992		K-4, K-5	3705		H-3	4434		D-16, D-17, D-18, D-19
1995		K-4, K-5	3706		H-3	4435		D-16, D-17, D-18, D-19
2000		C-4	3708		K-5, K-20	4438		K-11, K-20
2005		C-11, I-14	3709		K-5	4439		D-9, D-10, K-11, K-13, K-18
2007		A-39, N-3	3713		D-8, K-9	4447		D-21
2008		B-12, I-10	3714		D-9, K-10	4448		D-21
2009		B-5	3757		A-70	4449		D-21
2011		B-15	3766		M-2	4450		D-16, D-17, D-18, D-19, Q-2
2080		C-4	3768		D-14, M-2	4452		D-16, D-17, D-18, D-19
2140		P-3, P-5	3781		D-8, K-4, K-9, K-20	4453		D-18, D-19
2141		P-4	3785		D-8, K-9	4464		O-5
2142		P-4, P-5	3786		D-8, K-9	4476		G-4
2143		P-4	3797		M-2	4481		K-11
2144		P-4, P-5	3800		D-8, K-9	4482		K-11
2145		P-4	3801B-39, B-40, B-42, B-47, C-8, K-4, K-14,			4486		M-2
2146		P-3, P-4			K-15	4491		K-19, K-20
2147		P-3, P-4, P-5	3802		B-42, K-4	4492		K-20
2209		K-4, K-6	3803		B-42	4493		K-19, K-20
2415		P-5	3807		D-8, D-9, D-15, K-9	4512		M-9, R-3
2417		P-5	3814		K-5, K-20	4525		K-12
2685		J-7	3819		D-12, F-12	4526		K-12, K-20
2697		J-7	3856		D-16, D-17, D-18, D-19, J-12	4527		D-9, D-10, K-12, K-13, K-18
2698		B-42	3863		D-14, M-2	4533		O-5
2699		J-7	3865		D-8, K-9, K-20	4536		K-2
2701		K-5	3866		D-8, K-9	4537		K-11, K-20
2704		K-2, K-5	3867		D-8, K-9	4549		K-11
2705		K-5, K-20	3868		K-1	4550		P-2
2707		J-7	3869		K-20	4615		K-17
2711		K-2, K-6	3896		D-17, D-19, M-6	4616		B-15, K-17
2714		J-7	3947		D-14	4617		K-17
2715		J-7	3948		M-5	4800		O-3
2787		B-42, K-4	3952		B-5	5510		O-4
2851		H-1	4039		B-5	5523		G-4
2855		H-1, H-3	4091		B-5	5524		G-4
2856		H-1	4101		D-16, D-17, D-18, D-19	55717A-1, B-3, C-1, D-1, E-1, G-1, H-1, I-1, J-1,		
2859		G-4	4116		D-21	K-1, L-1, M-1, N-1, O-1, P-1, Q-1, R-1, I-18,		
2860		G-4	4119		D-16	6000		C-4
2863		H-2	4120		D-16, D-17, D-18, D-19	6100		H-5
2921		A-70	4125		M-3	6122		O-3
2974		P-2	4126		M-3	6420		H-5
2985		P-3, P-5	4130		D-14, M-3	6540		O-3
3000		P-2	4131		D-14, M-3	6710		H-5
3004		P-3, P-5	4132		D-14, M-3	6740		H-5
3082		H-2	4141		D-16, D-17, D-18, D-19	6940		O-3
3085		C-4	4143		D-17	6988		O-3
3112		K-6	4144		D-17, D-19, M-6	7260		O-3
3144		B-38	4149		D-17	7460		O-3
3175		B-42, K-2	4154		O-7	8612		C-4
3176		B-42, K-2	4174		O-7	20183		F-3, I-13
3196		J-7	4175		O-7	010001		J-14
3197		J-7	4184		M-5	010002		J-14
3312		D-7, D-8, J-12, K-9	4188		K-5	010003		J-14
3349		J-7	4224		D-12, F-12	010121		J-13
3407		D-12, F-12	4225		D-12, F-12	010161		J-13
3410		D-12, F-12	4238		O-7	010525		J-14
3418		D-12, F-12	4243		P-2	010600		J-13
3419		D-12, F-12	4248		P-2	010610		J-13
3438		H-2, H-6	4251		O-7	010620		J-13
3499		D-5, D-7, J-7	4259		O-7	010630		J-13
3530		D-12, F-12	4270		R-4	010640		J-13
3553		D-12, F-12	4283		D-16, D-17, D-18, D-19	010650		J-13
3577		J-7	4291		D-6	010660		J-13
3585		J-7	4294		D-8, K-9	010680		J-13
3586		J-7	4295		D-6	010800		J-8
3606		D-12, F-12	4296		D-6	010801		J-8
3625		D-14	4297		D-6	010802		J-8
3628		M-2	4308		D-9, K-10, K-20	010803		J-8

010806	J-8	012610	A-4	013624	A-45, A-56
010807	J-8	012612	A-4	013625	A-45, A-56
010812	J-8	012615	A-4	013626	A-56
010813	J-8	012701	A-54	013627	A-56
010814	J-8	012702	A-54	013628	A-56
010815	J-8	012703	A-54	013629	A-45, A-56
010816	J-8	012704	A-54	013635	A-26
010817	J-8	012705	A-55	013636	A-26
010900	J-6	012708	A-55	013642	A-38, A-49
010901	J-6	012710	A-54	013643	A-38, A-49
010906	J-6	012717	A-54	013644	A-38, A-49
010907	J-6	012722	A-54	013645	A-38, A-49
010912	J-6, J-17	012724	A-54	013646	A-49
010913	J-6, J-17	013110	A-59, A-60	013652	A-58
011012	J-9	013111	A-59, A-60	013653	A-58
011014	J-9	013124	A-25	013654	A-58
011020	J-10	013140	A-25	013660	A-34, A-35, A-50
011021	J-10	013141	A-25	013661	A-34, A-35, A-37, A-50
011022	J-9, J-17	013142	A-25	013662	A-34, A-35, A-37, A-50
011024	J-10, J-17	013143	A-25	013663	A-34, A-37, A-50
011030	B-26, J-10	013144	A-25	013664	A-34, A-37, A-50
011673	J-15, Q-1	013145	A-25	013665	A-34, A-37, A-50
011702	A-4, Q-1	013146	A-25	013666	A-50
011703	A-1, A-24, A-26, A-58, D-5, Q-3	013177	A-25	013670	A-45, A-56
011802	Q-1	013184	A-50, A-61, A-64	013671	A-45, A-56
011804	A-25, Q-1	013186	A-8, A-64	013672	A-45, A-56
012011	J-6	013219	D-5, J-11	013673	A-45, A-56
012012	J-6, J-17	013227	A-70, D-2	013674	A-45, A-56
012013	J-3, J-17	013334	B-41	013696	A-49
012014	J-3, J-17	013353	B-26	013945	B-41
012015	J-3	013381	B-26	013948	B-41
012016	J-3	013443	A-23	013949	B-49
012020	J-6	013475	A-23, A-60	013950	B-41
012029	J-5	013498	A-34, A-35, A-38, A-50	013978	A-43
012030	J-5	013499	A-34, A-35, A-50	014200	A-22
012031	J-5	013522	A-34, A-53	014201	A-22
012032	J-6	013523	A-17, A-34, A-53	014202	A-22
012033	J-5	013524	A-17, A-34, A-53	014203	A-22
012034	J-5	013525	A-34, A-53	014204	A-22
012035	J-4	013526	A-34, A-53	014205	A-22
012036	J-8, J-17	013527	A-34, A-53	014206	A-22
012037	J-8	013528	A-34, A-53	014207	A-22
012038	J-8	013529	A-53	014208	A-22
012039	J-8	013540	A-53	014270	A-22
012040	J-5	013542	A-34, A-35, A-38, A-50	014271	A-22
012041	J-5	013543	A-34, A-35, A-38, A-50	014394	A-23, A-60, A-62, A-63, A-65
012042	J-5	013544	A-34, A-35, A-37, A-38, A-50	014395	A-59, A-60
012043	J-5	013545	A-34, A-35, A-37, A-38, A-50	014396A-59, A-60, A-62, A-63, A-64, A-65	
012044	J-4	013546	A-34, A-37, A-38, A-50	014399	A-58, A-60, A-65
012045	J-4	013547	A-34, A-37, A-38, A-50	014407	D-2
012046	J-4, J-17	013548	A-34, A-37, A-38, A-50	014412	A-30
012047	J-4, J-17	013549	A-50	014413	A-29
012048	J-4, J-17	013550	A-28	014414	A-30
012051	J-3, J-17	013551	A-50	014415	A-29
012052	J-3	013554	A-28	014417	A-23
012053	J-3	013560	A-57	014420	A-43
012054	J-3	013561	A-57	014421	A-40, A-43
012055	J-3	013562	A-57	014422	A-40, A-43
012058	J-5, J-17	013563	A-57	014423	A-40, A-43
012059	J-5, J-17	013569	A-55	014424	A-40, A-43
012060	J-6	013570	A-55	014425	A-40, A-43
012061	J-6	013571	A-55	014426	A-40, A-43
012201	J-5, J-17	013572	A-55	014430	A-43
012202	J-5	013577	B-46	014431	A-43
012203	J-5	013580	A-58	014432	A-40, A-43
012204	J-5	013581	A-58	014433	A-43
012205	J-5	013582	A-58	014434	A-43
012310	A-70	013583	A-58, A-65	014435	A-43
012311	A-70	013587	A-57	014436	A-43
012405	K-17	013588	A-57	014437	A-43
012421	K-17	013589	A-57	014438	A-43
012600	A-4	013592	A-57	014439	A-43
012601	A-4	013593	A-58, A-62, A-65	014459	D-2
012602	A-4	013597	A-49	014465	A-25
012603	A-4	013619	A-58, A-60	014466	D-2
012604	A-4	013620	A-56	014477	A-57, A-61, A-62, A-63, A-64, A-65
012605	A-4	013621	A-56	014485	A-59, A-60
012606	A-4	013622	A-45, A-56	014508	A-9, A-59, A-60, A-62, A-63, A-64, A-65
012609	A-4	013623	A-45, A-56		

014510	A-43	400235	A-58	7204253	O-7
014518	A-65	1030088	D-6	7204478	K-12, K-19
014527	A-2	1060809	G-4	7204479	K-12
014528	A-40	1107089	A-59	7204483	L-2, L-4
014542	A-18	3134015	A-18	7204513	M-9, R-3
014543	A-18	3134016	A-18	7204563	P-2
014545	A-19, A-23, A-60	3134091	A-16	7204580	O-7
014549	A-1, A-5	3134092	A-16	7204582	O-7
014550	A-1, A-5	3134135	A-24	7204583	O-7
014568	B-26	3134143	D-2	7204584	O-7
014569	B-26	3134179	A-51	7204585	O-7
014581	B-26	3134180	A-51	7204586	O-7
014582	B-26	3134181	A-51	7204612	D-6
014598	A-40	3134182	A-51	7204613	O-5
014599	A-40	3134183	A-51	7204614	O-5
014617	B-44	3134184	A-51	7204708	K-2, K-6
014620	A-40	3134185	A-51	7204709	K-6
014621	A-40	3134186	A-51	7204711	K-1
014623	A-2, K-17	3134187	A-51	7204737	Q-3
014624	A-40	3134188	A-51	7204741	P-2
014626	A-40	3134189	A-51	7204767	A-16
014627	A-40	3134190	A-51	7204770	A-16
014639	A-40	3134191	A-51	7204771	A-16
014662	A-23	3134192	A-51	7204791	A-26
014670	B-50	3134193	A-51	7204792	A-26
014672	B-50	3134194	A-51	7204810	K-4, K-12
014695	A-25	3134213	A-48	7204811	K-4, K-12
014696	A-40, A-43	3134214	A-15	7204812	K-4, K-12
014698	A-60	3134216	J-13	7204823	O-5
014718	K-16	3134217	J-13	7204841	D-18
014719	K-16	3134221	A-52	7204863	K-4
014720	J-9	3134226	A-66	7204864	K-2
014723	A-38, A-45, A-49	3134227	A-66	7204865	K-4
014724	A-38, A-45, A-49	3134236	D-7, J-12	7204869	J-14
014725	A-62	3134237	D-7, J-12	7204895	K-17
014762	B-50	3134238	J-4	7204896	K-17
014765	J-4	3134239	J-9	7204910	K-4
014766	A-40, A-41	3134240	J-12	7204973	O-4
014767	A-40, A-41	3134250	A-48	7204983	O-4
014768	A-40, A-41	3134251	A-48	7205002	O-7
014769	A-40, A-41	3134252	A-48	7205010	O-7
014770	A-40, A-41	3134255	A-16	7205081	G-4
014771	B-50	3134257	A-16	7205122	A-22
014779	B-26, B-49, J-10	3134263	A-47	7205176	K-12
014800	A-48	3134266	J-12	7205177	P-3, P-5
014813	A-22	3134273	A-52	7205178	P-3, P-5
014814	A-22	3134274	A-52	7205179	P-3, P-5
014815	A-19	3134275	A-52	7205180	P-3, P-5
014816	A-23	3134276	A-52	7205305	F-8
014819	B-41	3134277	A-52	7205306	F-8
014820	B-41	3134281	A-24	7205307	F-8
014843	D-5, J-9, J-11	3134284	A-52	7205308	F-7
014844	D-5, J-11	3134295	A-15	7205309	F-7
014845	J-11	3134299	A-16	7205310	F-7
014846	D-5	3134300	K-19	7205311	F-7
014847	D-5	3134301	A-29	7205312	F-7
014848	D-5	6900074	K-2	7205313	F-7
014851	A-19, A-23	6900154	K-18	7205314	F-7
014859	A-13, A-15, A-23, A-60, A-62, A-63	6900221	C-8	7205315	F-8
014868	A-9	6900274	K-19	7205316	F-7
014870	A-40, O-1	6900284	K-11	7205317	F-7
014893	A-64	6900365	K-4	7205318	F-7
014896	D-5	6900392	D-9, K-11	7205319	F-7
014924	A-24, A-26	6900513	D-10, K-13	7205320	F-5
014925	A-24	6900678	C-13, F-10	7205321	F-5
014927	A-24	6900734	K-4, K-10	7205322	F-5
014953	A-30	6900833	J-12	7205323	F-5
015180	A-2	6900834	J-12	7205324	F-9
015181	A-2	6900853	D-9	7205325	F-9
015182	A-2	6900854	A-33, A-51	7205326	F-9
015184	A-2	6900871	B-50	7205327	F-9
015185	A-9, A-29	6900876	A-53	7205328	F-9
015186	A-1, A-2	6900927	D-12, F-12	7205329	F-9
346103	D-2	6900988	F-9	7205330	F-9
354001	B-38	6901012	A-15	7205331	F-9
354008	B-38	6901029	J-6	7205332	F-6
354009	B-38	6901177	A-16	7205334	F-6
354010	A-70	6905019	C-8	7205335	C-13, F-10
357280	A-30	7202210	K-4, K-6	7205336	C-13, F-10

7205341.....	C-13, F-10	7205532.....	A-47	7205806.....	H-8
7205343.....	C-13, F-10	7205539.....	A-66	7205807.....	H-7
7205345.....	F-8	7205548.....	B-46	7205808.....	H-7
7205349.....	F-6	7205549.....	M-1, M-5, M-8, R-2	7205809.....	H-7
7205351.....	P-2	7205558.....	M-8	7205832.....	R-4
7205354.....	G-4	7205560.....	D-12, F-12	7205835.....	R-4
7205355.....	G-4	7205561.....	M-8	7205836.....	R-4
7205357.....	D-12, F-12, G-2	7205565.....	M-8, R-2	7205861.....	R-4
7205360.....	C-7, C-10, C-18, K-7	7205565.....	I-17	7205868.....	R-4
7205362.....	R-4	7205587.....	A-48	7205874.....	K-12, K-20
7205363.....	R-4	7205588.....	A-48	7205895.....	H-8
7205366.....	K-2	7205604.....	Q-1	7205896.....	H-8
7205367.....	K-2	7205605.....	A-66	7205897.....	H-8
7205368.....	K-2	7205609.....	R-8	7205898.....	H-7
7205369.....	K-2	7205610.....	R-8	7205899.....	H-7
7205370.....	K-3, K-20	7205611.....	R-8	7205900.....	H-7
7205371.....	K-3, K-20	7205612.....	R-8	7205902.....	G-4
7205372.....	K-19, K-20	7205614.....	R-7	7205903.....	G-4
7205376.....	K-4	7205615.....	R-7	7205929.....	D-14
7205377.....	K-4	7205616.....	R-7	7205931.....	L-4
7205393.....	G-4	7205617.....	R-7	7205932.....	L-4
7205394.....	G-4	7205618.....	R-7	7205933.....	L-4
7205395.....	B-16, C-10, K-4	7205619.....	R-7	7205961.....	F-3, I-13
7205396.....	G-3	7205620.....	R-7	7205962.....	F-3, I-13
7205399.....	G-3	7205622.....	A-34, A-35, A-36, A-37, A-38,	7205971.....	F-5, G-2
7205440.....	I-17		A-54	7205972.....	R-4
7205441.....	I-17	7205637.....	A-28	7205975.....	A-57
7205442.....	I-17	7205638.....	A-28	7205976.....	A-57
7205443.....	I-17	7205639.....	A-28	7205977.....	A-57
7205455.....	F-13	7205640.....	A-19	7205978.....	A-57
7205456.....	F-13	7205641.....	A-19	7205979.....	J-4
7205457.....	F-13	7205642.....	A-19	7205983.....	J-9
7205458.....	F-13	7205643.....	A-19	7205984.....	K-12, K-18
7205459.....	F-8	7205644.....	A-19	7205989.....	K-18
7205461.....	O-5	7205645.....	A-19	7205993.....	D-10, K-13
7205462.....	M-9, R-3	7205646.....	A-19	7205999.....	D-9, D-10, K-13
7205463.....	M-9, R-3	7205647.....	A-19	7206010.....	F-4
7205465.....	M-9, R-3	7205648.....	A-19	7206011.....	F-4
7205466.....	M-8	7205649.....	A-21	7206012.....	F-4
7205468.....	F-13	7205650.....	A-21	7206013.....	F-4
7205470.....	F-13	7205651.....	A-21	7206058.....	O-4
7205474.....	D-12, F-12	7205652.....	A-21	7206083.....	O-7
7205476.....	D-12, F-12	7205653.....	A-21	7206094.....	O-7
7205477.....	D-12, F-12	7205654.....	A-21	7207000.....	J-4
7205493.....	A-67	7205655.....	A-21	7207001.....	A-19
7205494.....	A-67	7205656.....	A-21	7207002.....	A-19
7205495.....	A-67	7205657.....	A-21	7207003.....	A-19
7205496.....	A-67	7205658.....	A-21, A-23, A-60	7207004.....	A-19
7205497.....	A-67	7205659.....	A-23, A-60	7207005.....	A-19
7205498.....	A-67	7205668.....	F-9	7207006.....	A-19
7205499.....	A-67	7205669.....	F-9	7207007.....	A-19
7205500.....	A-67	7205681.....	D-14, M-4	7207008.....	A-19
7205501.....	A-67	7205682.....	D-14, M-4	7207009.....	A-19
7205502.....	A-67	7205683.....	G-3, Q-2, Q-3	7207019.....	D-5, Q-2
7205503.....	A-67	7205685.....	F-7	7207023.....	D-2
7205504.....	A-67	7205687.....	F-5	7207030.....	A-16
7205505.....	A-67	7205697.....	L-4	7207032.....	D-2, Q-2
7205506.....	A-67	7205699.....	L-4	7207034.....	B-46
7205507.....	A-66, Q-1	7205703.....	Q-3	7207036.....	D-5
7205508.....	A-67	7205727.....	F-9	7207046.....	J-5
7205509.....	A-67	7205774.....	I-17	7207047.....	J-8, J-17
7205510.....	A-67	7205777.....	M-8	7207048.....	J-8
7205511.....	A-67	7205783.....	K-4	7207049.....	J-4
7205512.....	A-67	7205785.....	H-4	7207050.....	J-4, J-17
7205513.....	A-67	7205786.....	H-4, H-7, H-8	7207051.....	J-4, J-17
7205514.....	Q-1	7205788.....	H-4, H-6	7207052.....	J-3, J-17
7205515.....	A-67	7205789.....	H-6	7207053.....	J-3
7205517.....	A-34, A-35, A-36, A-37, A-38,	7205790.....	H-6	7207054.....	J-5, J-17
	A-46	7205791.....	H-4, H-7, H-8	7207055.....	J-5, J-17
7205518.....	A-34, A-35, A-36, A-37, A-38,	7205792.....	H-6	7207057.....	J-3, J-17
	A-46	7205793.....	H-6	7207058.....	J-3, J-17
7205519.....	A-34, A-35, A-36, A-37, A-38,	7205794.....	H-6	7207059.....	J-9
	A-46	7205795.....	H-6	7207060.....	J-10
7205521.....	A-34, A-35, A-36, A-37, A-38,	7205797.....	L-4	7207061.....	J-9, J-17
	A-48	7205798.....	L-4	7207077.....	A-19
7205522.....	A-48	7205802.....	H-8	7207079.....	D-2
7205524.....	A-34, A-35, A-36, A-37, A-38,	7205803.....	H-8	7207083.....	J-4
	A-47	7205804.....	H-8	7207087.....	A-67
7205525.....	A-34, A-35, A-36, A-37, A-38,	7205805.....	H-8	7207088.....	A-67

7207089	A-67	7207340	B-38	7207649	A-53
7207097	A-67	7207342	A-30	7207650	A-53
7207098	A-67	7207357	A-3, A-15, A-45, Q-1, Q-3	7207656	J-5
7207099	A-67	7207358	A-18	7207657	J-5
7207103	A-67	7207359	A-15, A-18	7207658	J-3
7207105	A-67	7207369	A-15, A-18, Q-1, Q-3	7207659	J-3
7207106	A-67	7207398	P-2	7207660	J-3
7207107	A-67	7207477	A-18	7207661	J-5
7207113	B-41	7207478	A-18	7207662	J-5, J-17
7207114	B-41	7207479	A-18	7207663	J-5
7207154	A-21	7207480	A-18	7207664	J-3
7207163	A-17, A-53	7207481	A-18	7207665	J-5
7207164	A-17, A-53	7207482	A-34, A-35, A-50	7207666	J-5
7207165	A-17, A-53	7207483	A-34, A-35, A-38, A-50	7207667	J-3
7207167	A-17, A-36, A-51	7207484	A-34, A-35, A-38, A-50	7207668	J-4
7207168	A-17, A-36, A-51	7207485	A-34, A-35, A-37, A-38, A-50	7207669	J-8
7207169	A-17, Q-1	7207486	A-50	7207670	J-8
7207170	A-17	7207487	A-50	7207671	J-6
7207171	A-17, A-36, A-51	7207488	A-50	7207672	J-4, J-17
7207172	A-17, A-36, A-51	7207489	A-50	7207673	J-9, J-10
7207173	A-17, A-36, A-51	7207490	A-50	7207674	A-13
7207174	A-17, A-36, A-51	7207491	A-34, A-35, A-50	7207675	A-13
7207175	A-17, A-36, A-51	7207492	A-34, A-35, A-50	7207676	A-13
7207176	A-17, A-36, A-51	7207493	A-34, A-35, A-50	7207677	A-13
7207177	A-17, A-36, A-51	7207494	A-34, A-35, A-37, A-50	7207678	A-13
7207178	A-17, A-36, A-51	7207495	A-50	7207679	A-13
7207179	A-28	7207496	A-50	7207680	A-13
7207181	J-4	7207497	A-50	7207681	A-13
7207182	O-1	7207498	A-50	7207682	A-13
7207186	A-24	7207499	A-53	7207683	A-13
7207193	A-17	7207500	A-53	7207686	A-13
7207196	O-1	7207501	A-53	7207689	D-15
7207197	B-41, K-16	7207502	A-53	7207690	D-15
7207200	J-4	7207503	A-53	7207692	A-30
7207201	J-4	7207504	A-53	7207693	D-15
7207205	A-67	7207505	A-53	7207694	A-48
7207206	A-67	7207533	J-4	7207696	D-15, Q-2
7207207	A-67	7207539	B-50	7207697	D-15
7207208	A-67	7207540	B-50	7207698	D-15
7207209	A-67	7207541	B-50	7207699	C-9, J-10
7207210	A-67	7207544	C-9, J-6	7207700	C-9, J-9
7207212	A-67	7207545	C-9, J-6	7207701	K-4
7207213	A-67	7207547	J-4	7207702	A-59
7207214	A-67	7207552	J-3	7207703	A-52
7207215	A-67	7207553	J-9	7207704	A-19
7207216	A-67	7207554	A-14	7207705	A-21
7207220	A-9, A-59, A-60, A-63	7207555	A-14	7207707	A-12, A-15, A-19, A-21, A-31
7207221	A-59, A-60, A-61, A-63	7207557	A-14	7207721	D-15
7207222	A-23, A-60, A-62, A-63	7207558	A-14	7207724	A-57
7207223	A-45	7207560	A-14	7207725	A-24
7207227	A-22, A-62, A-65, K-16	7207561	A-14	7207726	A-24
7207228	A-22, K-16	7207562	A-14	7207730	D-15
7207229	A-22, K-16	7207563	A-14	7207731	C-9, J-9
7207247	A-16	7207564	A-14	7207732	C-9, J-9
7207248	A-16	7207565	A-14	7207733	C-9, J-3
7207249	A-16	7207566	A-14	7207734	C-9, J-3
7207250	A-16	7207567	A-14	7207735	C-9, J-5
7207256	A-21	7207568	A-14	7207736	C-9, J-4
7207257	A-21	7207581	A-14	7207737	C-9, J-4
7207258	A-21	7207598	D-7, J-11	7207738	A-63
7207259	A-21	7207599	D-7, J-11	7207739	B-46
7207260	A-21	7207600	D-7, J-11	7207741	D-15
7207261	A-21	7207601	D-7, J-11	7207751	C-7, K-7
7207262	A-21	7207602	D-7, J-11	7207753	B-46
7207263	A-21	7207607	A-14	7207754	A-15
7207264	A-21	7207608	A-14	7207760	C-8, J-12
7207268	A-21	7207636	A-13, A-15	7207761	A-52
7207281	A-45	7207637	A-53	7207762	A-52
7207282	A-45, A-46	7207638	A-53	7207763	A-52
7207283	A-45, A-46	7207639	A-53	7207764	A-52
7207284	A-45, A-59, A-60	7207640	A-53	7207765	A-52
7207285	A-45, A-56	7207641	A-53	7207766	A-52
7207291	A-45	7207642	A-53	7207767	A-52
7207292	A-45	7207643	A-53	7207768	A-52
7207294	J-4	7207644	A-53	7207769	A-52
7207295	J-4	7207645	A-53	7207770	A-52
7207296	J-4	7207646	A-53	7207772	B-46
7207301	A-16	7207647	A-53	7207773	B-46
7207315	A-9, A-17, A-50	7207648	A-53	7207775	A-60, A-62



7207776.....	A-52	7209105.....	B-11	7209456.....	A-70
7207783.....	A-15	7209107.....	B-11	7209457.....	A-70
7207789.....	D-9, D-10, K-12, K-13	7209108.....	B-11	7209458.....	A-70
7207801.....	O-4, O-7	7209109.....	B-11	7209459.....	A-70
7207802.....	O-4	7209111.....	B-11	7209460.....	A-70
7207812.....	O-7	7209114.....	B-10	7209461.....	Q-4
7207868.....	D-7	7209115.....	B-9	7209462.....	Q-4
7207875.....	D-15	7209118.....	D-1	7209463.....	Q-4
7207878.....	A-53	7209119.....	B-11	7209464.....	Q-4
7207898.....	K-11	7209120.....	B-11	7209468.....	Q-4
7207900.....	M-6	7209121.....	B-11	7209469.....	Q-4
7207913.....	K-11	7209134.....	B-47, J-12	7209470.....	Q-4
7207916.....	A-14	7209145.....	B-49, C-17	7209477.....	A-3
7207918.....	A-14	7209152.....	B-46	7209478.....	A-3
7207919.....	A-14	7209153.....	B-46	7209480.....	A-3
7207920.....	A-14	7209154.....	B-46	7209481.....	A-3
7207921.....	A-14	7209155.....	B-46	7209483.....	A-3
7207923.....	A-14	7209156.....	B-46	7209485.....	A-3
7207924.....	A-14	7209157.....	B-46	7209489.....	F-7
7207925.....	A-63	7209158.....	B-46	7209491.....	B-49
7207926.....	A-63	7209160.....	B-46	7209492.....	B-48
7207934.....	C-10, K-7, Q-2	7209161.....	B-46	7209493.....	B-47
7207935.....	D-7, Q-2	7209165.....	B-11	7209494.....	B-47, B-48
7207940.....	A-63	7209182.....	B-45, Q-2	7209495.....	B-47
7208132.....	M-4	7209203.....	A-63	7209496.....	B-45, B-47
7208133.....	D-14, M-3	7209204.....	A-64	7209497.....	B-45, B-47
7208207.....	G-4	7209211.....	F-8	7209498.....	B-45, B-47
7208208.....	G-4	7209214.....	A-34, A-35, A-36, A-37, A-38,	7209499.....	B-45, B-47
7208209.....	Q-3		A-53	7209502.....	B-9, B-10
7208298.....	R-6	7209216.....	A-64	7209506.....	D-1
7208299.....	R-6	7209217.....	A-62	7209540.....	R-6
7208300.....	R-6	7209218.....	A-62	7209541.....	R-6
7208302.....	R-6	7209234.....	A-66	7209542.....	R-6
7208305.....	R-6	7209235.....	A-66	7209597.....	I-6
7208329.....	P-3, P-5	7209236.....	A-66	7209628.....	I-11
7208332.....	M-7	7209237.....	A-66	7209629.....	I-11, I-16
7208333.....	M-7	7209281.....	A-52	7209630.....	I-11
7208656.....	A-15, A-27	7209282.....	A-52	7209631.....	I-11, I-16
7208661.....	A-15	7209283.....	A-52	7209632.....	I-11, I-16
7208662.....	A-15	7209303.....	F-7	7209633.....	I-11
7208663.....	A-15	7209313.....	A-63	7209641.....	I-9, I-16
7208664.....	A-15	7209335.....	F-9	7209643.....	I-12, I-16
7208665.....	A-18	7209339.....	O-1	7209644.....	I-12, I-16
7208666.....	A-18	7209340.....	O-1	7209645.....	I-12, I-16
7208667.....	A-18	7209345.....	C-7, K-7	7209646.....	C-12, I-12, I-15
7208678.....	A-9, A-59, A-60, A-61, B-28	7209349.....	C-7, K-7	7209647.....	I-12
7208679.....	J-3	7209350.....	C-10	7209648.....	I-12
7208681.....	A-24	7209351.....	C-10, K-12	7209649.....	I-12
7208685.....	J-3	7209371.....	A-15	7209650.....	I-9
7208686.....	A-34, A-35, A-50	7209373.....	A-15	7209651.....	I-9
7208717.....	A-24	7209391.....	H-5	7209652.....	I-9
7209008.....	A-31	7209392.....	H-5	7209653.....	I-9
7209012.....	A-13	7209393.....	H-5	7209654.....	I-9
7209013.....	A-13	7209394.....	H-5	7209655.....	I-9
7209014.....	A-13	7209395.....	H-5	7209656.....	I-9, I-16
7209015.....	A-13	7209396.....	H-7	7209657.....	I-9
7209016.....	A-13	7209397.....	H-7	7209658.....	I-9
7209017.....	A-13	7209402.....	D-14	7209659.....	I-9
7209018.....	A-13	7209409.....	A-16	7209684.....	I-8
7209019.....	A-13	7209410.....	A-16	7209685.....	I-8
7209020.....	A-13	7209411.....	A-16	7209686.....	I-8
7209021.....	A-13	7209412.....	A-16	7209687.....	I-6, I-16
7209022.....	A-13	7209413.....	A-16	7209692.....	I-6
7209023.....	A-13	7209414.....	A-16	7209693.....	I-6
7209025.....	F-6	7209415.....	A-16	7209700.....	F-3, I-13
7209026.....	F-6	7209416.....	A-16	7209709.....	O-7
7209027.....	F-6	7209417.....	B-10	7209712.....	R-6
7209028.....	F-5	7209441.....	A-28	7209721.....	A-29
7209029.....	F-5	7209442.....	A-28	7209737.....	A-31
7209030.....	F-5	7209443.....	A-28	7209738.....	A-31
7209031.....	F-5	7209446.....	A-28	7209739.....	A-31
7209032.....	F-5	7209447.....	A-28	7209761.....	O-7
7209042.....	O-5	7209448.....	A-28	7209762.....	O-7
7209065.....	D-12, F-12	7209450.....	A-70	7209775.....	O-7
7209066.....	A-53	7209451.....	A-70	7209777.....	R-6
7209071.....	G-4	7209452.....	A-70	7209779.....	A-16
7209075.....	F-6	7209453.....	A-70	7209829.....	B-45
7209077.....	F-7	7209454.....	A-70	7209836.....	O-7
7209085.....	D-12, F-12	7209455.....	A-70	7209848.....	O-7

7209849.....	O-7	7210155.....	A-62	7210624.....	A-44
7209850.....	O-7	7210157.....	A-63	7210625.....	A-44
7209851.....	O-7	7210192.....	O-6	7210629.....	A-44
7209852.....	O-7	7210211.....	B-6	7210630.....	A-44
7209853.....	O-7	7210212.....	B-6	7210631.....	A-44
7209855.....	F-3, I-13	7210214.....	B-9	7210633.....	A-44
7209856.....	O-7	7210215.....	B-9	7210637.....	A-44
7209857.....	K-18	7210225.....	B-45	7210638.....	A-44
7209862.....	A-29	7210226.....	B-45	7210639.....	A-44
7209874.....	C-10	7210227.....	B-45	7210693.....	B-43
7209878.....	J-8	7210269.....	B-9	7210694.....	M-4
7209908.....	K-18	7210284.....	K-19	7210695.....	I-9
7209923.....	K-18	7210300.....	B-9	7210696.....	I-9
7209926.....	A-29	7210301.....	D-1	7210697.....	I-9
7209932.....	R-4	7210302.....	B-23	7210698.....	I-9
7209934.....	R-4	7210303.....	D-1	7210699.....	I-9
7209936.....	R-4	7210304.....	B-6	7210700.....	I-9
7209938.....	R-4	7210309.....	B-6	7210707.....	B-23
7209940.....	R-4	7210378.....	B-45	7210708.....	B-9
7209942.....	R-4	7210380.....	F-3, I-13	7210709.....	B-9
7209944.....	R-4	7210384.....	K-18	7210710.....	B-7
7209946.....	B-6, B-7	7210385.....	K-18	7210711.....	B-7
7209950.....	A-1	7210392.....	C-7, K-7	7210712.....	B-7
7209951.....	A-9, A-29	7210423.....	B-17, B-44, C-14	7210713.....	B-7
7209953.....	K-18	7210424.....	B-17, B-44, C-14	7210715.....	D-9, D-10, K-12, K-13
7209954.....	K-18	7210425.....	B-17, B-44, C-14	7210716.....	M-1
7209956.....	K-18	7210426.....	B-17, B-44, C-14	7210719.....	F-5
7209957.....	K-18	7210427.....	B-44	7210721.....	M-1, M-5, M-8, R-2
7209958.....	K-18	7210438.....	C-12, I-10, I-15	7210730.....	C-9, J-5
7209959.....	K-19	7210450.....	A-1	7210731.....	C-9, J-5
7209965.....	K-4	7210481.....	O-7	7210745.....	A-20
7209983.....	F-3, I-13	7210482.....	O-7	7210746.....	A-20
7210038.....	A-27	7210483.....	O-7	7210747.....	A-20
7210039.....	A-27	7210484.....	O-7	7210748.....	A-20
7210040.....	A-27	7210486.....	F-4	7210749.....	B-32, B-36, D-4
7210080.....	A-7	7210488.....	D-12, F-12	7210751.....	F-8
7210081.....	A-7	7210491.....	I-8	7210752.....	D-15
7210082.....	A-7	7210499.....	F-8	7210753.....	D-7, J-11
7210083.....	A-7	7210529.....	O-3	7210754.....	D-7, J-11
7210084.....	A-7	7210532.....	O-3	7210755.....	D-7, J-11
7210085.....	A-7	7210533.....	O-1, O-4	7210756.....	D-7, J-11
7210086.....	A-7	7210534.....	O-1	7210757.....	J-9
7210087.....	A-7	7210551.....	B-31, B-33, B-34	7210758.....	C-8, C-17, J-13
7210088.....	A-7	7210552.....	B-31, B-33, B-34	7210760.....	A-20
7210111.....	I-8	7210553.....	B-31, B-33, B-34	7210762.....	A-20
7210112.....	I-8	7210554.....	B-31, B-33, B-34	7210764.....	A-20
7210113.....	I-8	7210555.....	B-31, B-33, B-34	7210767.....	A-20
7210114.....	O-7	7210556.....	B-34	7210812.....	I-6
7210116.....	B-10, B-49	7210557.....	B-34	7210819.....	B-6, B-7
7210118.....	A-22, A-62, A-65, K-16	7210558.....	B-34	7210868.....	I-6
7210119.....	A-22, K-16	7210559.....	B-31, B-34	7210869.....	I-6
7210120.....	A-22, K-16	7210560.....	B-33, B-34	7210870.....	I-6
7210121.....	K-16	7210563.....	B-34	7210871.....	I-6
7210122.....	K-16	7210564.....	B-34	7210872.....	I-6
7210126.....	K-17	7210566.....	Q-5	7210897.....	I-6
7210131.....	A-19	7210567.....	Q-5	7210898.....	I-6
7210132.....	A-19	7210568.....	Q-5	7210909.....	F-8
7210133.....	A-19	7210569.....	B-32, B-34, B-36, C-5, D-3, D-4	7210910.....	M-4
7210134.....	A-19	7210570.....	A-69, B-30, B-31, B-32, B-34, B-36, D-3, D-4	7210914.....	B-29
7210135.....	A-19			7210915.....	B-29
7210136.....	A-19	7210571.....	B-31, B-32, B-34	7210976.....	F-8
7210137.....	A-19	7210572.....	B-32, B-36, D-4	7210977.....	A-1, I-10
7210138.....	A-19	7210573.....	B-31, B-32	7210979.....	C-13, F-10
7210139.....	A-19	7210574.....	B-32, B-36, D-4	7210980.....	F-6
7210140.....	A-21	7210575.....	B-36, D-4	7210987.....	M-2
7210141.....	A-21	7210576.....	B-31, B-32, B-34	7210988.....	F-6
7210142.....	A-21	7210577.....	B-31, B-32, B-34, D-3, D-4	7210994.....	B-32
7210143.....	A-21	7210582.....	C-10	7210995.....	B-32
7210144.....	A-21	7210583.....	C-10	7210996.....	B-33
7210145.....	A-21	7210584.....	C-10	7210997.....	B-34
7210146.....	A-21	7210605.....	A-44	7211004.....	L-2
7210147.....	A-21	7210606.....	A-44	7211005.....	L-2
7210148.....	A-21	7210607.....	A-44	7211006.....	L-2
7210149.....	A-57, A-62, A-63, A-64, A-65	7210608.....	A-44	7211007.....	L-2
7210150.....	A-65	7210609.....	A-44	7211008.....	L-2
7210151.....	A-62	7210610.....	A-44	7211009.....	L-2
7210152.....	A-64	7210618.....	A-44	7211010.....	L-1
7210153.....	A-64	7210619.....	A-44	7211011.....	L-2
7210154.....	A-62	7210623.....	A-44	7211014.....	L-3

7211015	A-27	72200146	A-6	72200617	F-1, F-9, G-2
7211020	B-43, B-47	72200147	A-6	72200619	C-18
7211021	B-43	72200148	A-6	72200623	K-6
7211033	F-6	72200149	A-6	72200626	C-2, C-3
7211054	K-11	72200150	A-6	72200627	C-2
7211055	K-11	72200151	A-6	72200630	C-2
7211075	K-11	72200152	A-6	72200631	C-2
7211077	M-7, R-2	72200153	A-6	72200632	C-2
7211078	M-7, R-2	72200154	A-6	72200633	C-2, C-3
7211079	M-7, R-2	72200155	A-6	72200634	C-2
7211080	B-29	72200195	B-37	72200635	C-2
7211081	B-29	72200204	O-1, O-3, O-4	72200636	C-2
7211094	K-11	72200205	O-1, O-3, O-4	72200637	C-2
7211096	B-35	72200207	L-1	72200638	C-2
7211097	B-35	72200210	L-1	72200639	C-2
7211098	B-35	72200213	L-1	72200643	C-3, D-3
7211099	B-35	72200216	L-1	72200658	B-40, K-15
7211100	B-35	72200219	L-1	72200659	B-35
7211104	B-35	72200222	L-1	72200660	D-3
7211105	B-35	72200225	L-1	72200664	D-3
7211137	A-12	72200228	L-1	72200665	D-3
7211138	A-12, A-61	72200231	L-1	72200666	D-3
7220379	A-42	72200234	L-1	72200668	B-34
7220531	O-3	72200237	L-1	72200669	C-2, C-3
8001701	M-1, M-2, M-6, O-5	72200239	B-25	72200670	C-2
8003734	K-20	72200242	O-1	72200671	C-2
8005600	L-2	72200315	O-6	72200672	C-2
8006333	O-5	72200393	O-7	72200673	C-2
8006517	K-20	72200402	K-4	72200675	C-3, D-3
8006652	K-20	72200411	K-10	72200676	C-3
8006653	K-1, K-20	72200414	C-13, F-10	72200677	C-3
8010199	K-20	72200418	B-44	72200681	C-12, I-11, I-15
8011677	K-11, K-20	72200419	B-17, B-44, C-14	72200682	C-12, I-12, I-15
8012760	O-5	72200422	O-6	72200683	C-12, I-9, I-15
8013378	L-2	72200424	B-40, C-18, K-15	72200686	B-23
8013380	L-2	72200425	B-40, K-15	72200687	B-9
8100001	G-4	72200426	B-40, K-15	72200688	B-7
8100002	G-4	72200427	B-40, K-15	72200689	B-20
8101109	G-4	72200428	B-40, K-15	72200690	B-20
8101544	G-4	72200429	B-40, K-15	72200716	J-5
8101720	G-4	72200430	B-40, K-15	72200718	C-3
8101724	G-4	72200431	B-40, K-15	72200719	J-5
8101765	G-4	72200432	B-40, K-15	72200722	F-9
8102581	G-4	72200433	B-40, K-15	72200723	F-9
8103998	H-5	72200436	C-18	72200724	F-9
8104237	Q-3	72200437	C-18	72200725	F-9
8104907	H-6	72200439	C-18	72200726	F-9
8104908	H-4	72200440	C-18	72200727	F-9
8104983	B-38	72200442	C-18	72200728	F-9
10600055	O-1	72200445	C-18	72200729	F-9
10600433	P-1	72200446	C-18	72200730	F-9
15001065	B-15	72200481	B-34	72200731	F-9
40000202	A-30	72200482	B-34	72200733	M-4
40005103	D-2	72200483	B-35	72200747	L-3
72071714	A-35	72200484	B-35	72200752	B-23
72071715	A-35	72200485	B-35	72200755	B-9
72077491	A-38	72200486	B-35	72200758	B-9
72200004	K-20	72200487	B-35	72200759	B-9
72200009	K-18	72200488	B-35	72200760	B-23
72200010	K-18	72200494	C-13, F-10	72200763	B-23
72200011	K-18	72200510	P-2	72200764	B-10
72200012	K-18	72200529	P-2	72200765	B-10
72200013	K-18	72200552	L-1	72200766	B-9
72200014	K-18	72200559	N-1	72200767	B-10
72200026	C-8, C-10	72200561	N-1	72200768	B-10
72200027	C-8, C-10, K-2, K-3, K-8	72200568	P-1	72200769	B-9
72200035	O-3, O-4	72200571	N-1	72200774	B-20
72200036	F-6	72200580	P-1	72200775	B-20
72200080	C-13, F-10	72200581	P-1	72200777	B-7
72200081	F-8	72200582	P-1	72200778	B-7
72200082	C-13, C-18, F-10	72200583	P-1	72200779	B-7
72200083	K-20	72200584	P-1	72200780	B-7
72200084	K-20	72200585	P-1	72200783	B-20
72200095	F-8	72200586	P-1	72200785	B-6
72200096	C-6, C-7, K-7	72200587	P-1	72200786	B-6
72200097	C-6, C-7, K-7	72200588	P-1	72200787	B-6
72200098	C-7, K-7	72200589	N-1	72200788	B-6
72200121	D-9, D-10, K-13	72200598	P-1	72200789	B-7
72200134	A-7	72200616	F-1, F-9, G-2	72200795	D-1

72200796	D-1	72200948	A-8, A-61	72201245	A-33
72200803	C-18	72200949	E-3	72201246	A-33
72200812	O-1	72200950	E-3	72201247	A-33
72200813	O-1	72200951	E-3	72201248	A-33
72200814	O-1	72200952	E-3	72201249	A-33
72200815	O-1	72200954	E-3	72201250	A-33
72200816	O-1	72200955	E-3	72201252	A-33
72200817	O-1	72200956	E-3	72201321	G-1
72200819	B-6, B-7	72200957	E-3	72201355	C-7, C-10, C-18, K-7
72200820	B-6, B-7	72200958	E-3	72201356	I-6
72200829	K-1, K-20	72200959	E-3	72201361	B-17, B-44, C-14
72200830	K-1, K-20	72200960	E-3	72201364	C-3, C-4
72200831	K-3	72200961	E-3	72201374	K-19
72200832	K-3	72200962	E-3	72201375	K-19
72200839	A-8	72200963	E-3	72201376	D-5
72200840	A-8	72200964	E-3	72201377	D-5
72200841	A-8	72200965	E-3	72201378	D-5
72200842	A-8	72200990	C-1	72201379	D-5
72200843	A-8	72200992	O-4	72201388	B-17, B-19, B-20, B-24, B-25, C-14, C-16
72200844	A-8	72200993	O-4	72201389	B-17, B-19, B-20, B-24, B-25, C-16
72200867	B-8, B-13, B-14, B-16, B-17, B-20, B-21, B-22, B-24, B-25	72201014	E-1	72201390	B-17, B-19, B-20, B-24, B-25, C-14, C-16
72200872	F-1, F-9, G-2	72201015	E-1	72201391	B-17, B-19, B-20, B-24, B-25, C-16
72200873	G-1, G-3	72201016	E-1	72201392	B-17, B-19, B-20, B-24, B-25, C-14, C-16
72200875	L-1	72201021	K-3	72201393	B-17, B-19, B-20, B-24, B-25, C-14, C-16
72200879	B-13, B-14, B-16, B-17, B-20, B-21, B-22, B-25	72201022	K-3	72201394	B-17, B-19, B-20, B-24, B-25, C-16
72200880	C-7, K-7	72201029	G-1	72201395	B-17, B-19, B-20, B-24, B-25, B-25, C-16
72200881	C-7, K-7	72201033	G-1	72201406	B-9, B-11
72200882	C-7, K-7	72201036	G-1	72201407	B-9, B-11
72200883	C-7, K-7	72201040	G-1	72201407	O-7
72200884	C-7, K-7	72201042	G-1	72201420	O-7
72200885	C-7, K-7	72201045	G-1	72201421	O-2
72200886	B-17, B-29, C-14	72201048	G-1	72201422	O-2
72200887	B-17, B-29, C-14	72201051	G-1	72201423	O-2
72200888	L-3	72201054	G-1	72201425	C-5
72200891	L-2	72201060	G-1	72201426	C-5
72200895	B-14	72201076	B-44	72201427	C-5
72200899	B-40, C-18, K-15	72201078	O-1	72201428	B-31, B-32
72200900	B-40, K-15	72201079	O-1	72201429	C-5
72200902	B-39, C-18, K-14	72201081	O-1	72201438	O-7
72200903	B-39, K-14	72201092	G-3	72201439	K-1
72200904	B-39, K-14	72201096	O-8	72201440	K-1
72200905	B-39, K-14	72201105	B-16, B-18, B-24, C-15	72201440	K-1
72200906	B-39, K-14	72201106	B-16, B-18, B-24, C-15	72201450	B-8, B-12, B-13, B-14
72200907	B-39, K-14	72201107	B-16, B-18, B-24, C-15	72201451	K-19
72200908	B-39, K-14	72201108	B-16, B-18, B-22, B-24	72201464	O-3
72200909	B-39, K-14	72201110	B-16, B-18, B-24, C-15	72201490	A-1
72200910	B-39, C-18, K-14	72201111	B-16, B-18, B-24, C-15	72201491	A-1
72200911	B-39, K-14	72201112	B-16, B-18, B-24, C-15	72201492	A-1
72200912	B-39, K-14	72201144	B-20, B-25	72201493	A-1
72200913	B-39, C-18, K-14	72201177	B-47, B-49	72201494	A-1
72200914	B-39, K-14	72201178	B-6, B-7	72201495	A-1
72200915	B-39, K-14	72201179	B-48	72201500	D-11, F-11, G-2
72200916	B-39, K-14	72201180	B-47, B-48	72201503	D-11, F-11, G-2
72200917	B-32	72201181	B-47, B-48	72201504	D-11, F-11
72200918A-69, B-31, B-32, B-34, B-36, D-4		72201183	B-35	72201505	D-11, F-11
72200923	E-2	72201184	B-33, B-35	72201506	D-11, F-11
72200924	E-2	72201185	B-34	72201507	D-11, F-11
72200925	E-2	72201186	B-45, B-47	72201509	D-11, F-11
72200926	E-2	72201187	B-45, B-47	72201510	D-11, F-11
72200927	E-2	72201190	A-12	72201512	D-11, F-11
72200928	E-2	72201191	A-12	72201513	D-11, F-11
72200929	E-2	72201192	A-12	72201514	D-11, F-11
72200930	E-1	72201193	A-12	72201515	D-11, F-11
72200931	E-1	72201194	A-12	72201517	D-11, F-11
72200932	E-1	72201197	K-13	72201518	D-11, F-11
72200933	E-1	72201201	A-10, A-12, A-61	72201519	D-11, F-11
72200934	E-1	72201206	A-6	72201520	D-11, F-11
72200935	E-1	72201207	A-6	72201537	A-1
72200936	E-1	72201208	A-6	72201540	C-2, C-3
72200937	E-3	72201209	A-6	72201541	B-16, C-15
72200938	E-3	72201210	A-6	72201542	B-16, C-15
72200939	E-3	72201211	A-6	72201543	B-16, C-15
72200940	E-3	72201212	A-6, A-30	72201550	D-3, D-4
72200941	E-3	72201213	B-47, B-49	72201551	D-3, D-4
72200942	E-3	72201240	A-33	72201552	D-3, D-4
72200943	E-3	72201241	A-33	72201576	B-8
72200944	E-3	72201242	A-33		
		72201243	A-33		
		72201244	A-33		

72201577	B-8	72201787	A-11	72202023	O-3
72201578	B-8	72201788	A-11	72202024	O-3
72201579	B-8	72201789	A-11	72202026	O-2
72201590	C-7, K-7	72201790	A-11	72202027	O-2
72201594	A-9, A-31	72201791	A-11	72202028	O-2
72201597	C-1, M-4, M-5	72201792	D-8, D-10, K-13	72202038	D-1
72201598	C-1, M-4, M-5	72201795	D-5	72202039	D-1
72201600	A-6, A-30	72201796	B-39, B-40, K-14, K-15	72202040	D-1
72201627	K-1	72201805	D-1	72202042	B-47
72201628	K-1	72201806	D-1	72202044	B-24
72201634	K-16	72201811	C-6	72202056	D-3
72201635	O-5	72201812	D-2	72202060	C-5
72201636	C-3	72201813	D-2	72202061	C-5
72201658	K-16	72201814	D-2	72202062	C-5
72201659	B-47, B-49	72201816	C-1, M-5	72202065	B-47, B-48
72201660	B-47, B-49	72201824	B-16, B-18, C-15	72202067	D-1
72201661	B-26, B-47, B-49	72201825	B-13	72202082	D-1
72201674	C-6	72201826	B-13	72202087	C-1, M-4
72201681	B-8	72201831	C-6	72202088	C-1, M-4
72201682	B-8	72201832	C-6	72202090	M-4
72201683	B-8	72201840	B-43	72202110	M-7, R-1
72201684	B-8	72201846	B-40, K-15	72202111	M-7, R-1
72201688	B-48	72201847	C-6	72202112	M-7, R-1
72201693	K-1	72201849	D-8, D-10, K-13	72202114	D-3
72201697	B-13	72201861	A-26	72202116	B-2, B-3, B-4, B-12
72201698	B-13	72201862	A-26	72202119	C-17
72201699	O-5	72201863	A-26	72202120	C-17
72201702	B-21	72201864	A-26	72202138	I-3
72201703	B-22	72201865	A-26	72202139	I-3
72201704	B-22	72201881	D-1	72202140	I-3
72201705	B-21	72201882	D-1	72202141	I-3
72201706	B-22	72201883	A-34, A-68	72202142	I-3
72201707	B-2, B-3, B-4, B-8, B-12, B-13	72201884	A-34, A-68	72202143	I-3
72201708	B-2, B-3, B-4, B-8, B-13	72201885	A-34, A-68	72202144	I-3
72201712	K-1	72201886	A-34, A-68	72202145	I-3
72201713	A-34, A-35, A-36, A-48	72201887	A-12	72202146	I-3
72201714	A-34, A-36, A-48	72201888	A-12	72202147	I-3
72201715	A-34, A-36, A-37, A-48	72201889	A-12	72202148	I-3
72201716	A-34, A-37, A-48	72201890	A-12	72202149	I-1
72201717	A-34, A-37, A-48	72201891	A-12	72202151	I-1
72201724	C-2	72201892	A-12	72202153	D-6, D-7
72201725	C-2, C-4	72201893	A-12	72202154	D-6, D-7
72201727	C-6	72201898	C-1, M-5	72202155	D-6, D-7
72201730	O-5	72201899	B-13	72202161	O-8
72201731	A-34, A-35, A-36, A-37, A-38	72201915	B-1, B-3, B-4, B-12, B-13, B-47	72202162	O-8
72201732	A-34, A-35, A-36, A-37, A-48, A-68	72201918	B-19, B-20, B-21	72202163	O-8
72201733	A-34, A-55	72201919	N-1	72202164	O-8
72201734	A-34, A-55	72201938	A-12	72202165	B-19, C-16, C-18
72201735	A-34, A-57	72201939	A-12	72202172	C-2
72201736	A-34, A-68	72201941	A-12	72202189	B-28
72201737	A-34, A-35, A-36, A-48	72201942	A-12	72202190	B-27
72201741	C-6, C-7, K-7	72201965	A-35, A-45	72202191	B-27
72201742	C-6, C-7, K-7	72201966	A-36, A-45	72202192	B-27
72201743	C-7, K-7	72201967	A-37, A-45	72202193	B-27
72201745	O-1, O-4	72201968	A-38, A-45	72202194	B-27
72201746	A-34, A-45	72201969	A-33	72202195	B-27
72201747	M-4	72201970	A-33	72202196	B-27
72201751	D-8, D-9, D-10, K-13	72201971	A-33	72202197	B-27
72201752	D-8, D-9, D-10, K-13	72201972	A-33	72202198	B-27
72201768	A-11	72201973	A-33	72202202	B-27
72201769	A-11	72201974	A-33	72202210	C-17
72201770	A-11	72201975	A-33	72202213	F-3, I-13
72201771	A-11	72201976	A-33	72202225	A-26
72201772	A-11	72201977	A-33	72202226	A-26
72201773	A-11	72201978	A-33	72202230	A-26
72201774	A-11	72201991	B-18, C-15	72202231	A-26
72201775	A-11	72201992	B-18, C-15	72202232	A-26
72201776	A-11	72201993	B-18, C-15	72202233	A-26
72201777	A-11	72201994	B-19, C-16	72202234	A-26
72201778	A-11	72201995	B-19	72202235	A-26
72201779	A-11	72201996	B-19	72202236	A-26
72201780	A-11	72202003	C-7, K-7	72202259	A-11
72201781	A-11	72202004	C-7, K-7	72202260	A-10, A-11
72201782	A-11	72202005	J-6	72202261	A-11
72201783	A-11	72202009	A-59, A-61	72202262	A-11
72201784	A-11	72202019	D-1	72202263	A-10, A-11
72201785	A-11	72202020	O-3	72202264	A-11
72201786	A-11	72202021	O-3	72202265	A-11
		72202022	O-3	72202266	A-11

72202267	A-10, A-11	72202464	M-7, R-1	72202788	A-29
72202268	A-11	72202465	B-29, M-7, R-1	72202791	K-4, K-12
72202269	A-11	72202466	B-31, B-32	72202796	A-61
72202270	A-11	72202467	A-1	72202797	A-61
72202271	A-11	72202468	A-1	72202798	A-61
72202272	A-10, A-11	72202469	A-1	72202799	A-61
72202273	A-11	72202475	A-12	72202810	A-23, A-60
72202274	A-11	72202487	C-8, J-13	72202816	A-59, A-60
72202275	A-11	72202491	I-1	72202817	A-59, A-60
72202276	A-10, A-11	72202494	B-44	72202843	A-10
72202277	A-11	72202503	B-47	72202868	A-4
72202278	A-11	72202504	B-24	72202872	A-59, A-60
72202279	A-10, A-11	72202508	B-28	72202873	A-23, A-60
72202280	A-11	72202509	B-28	72202881	A-17, A-23, A-60
72202281	A-11	72202510	B-28	72202890	B-18
72202282	A-11	72202513	B-28	72202893	B-4
72202283	B-28	72202514	B-28	72202894	B-4
72202284	B-28	72202517	J-9	72202895	B-4
72202285	B-28	72202530	F-1	72202896	B-4
72202290	B-49	72202531	F-1	72202897	B-4
72202291	B-49	72202534	F-1	72202898	B-4
72202292	B-49	72202544	A-9	72202899	B-4
72202293	B-49	72202547	A-33	72202900	B-4
72202297	B-27	72202583	C-17	72202901	B-12
72202298	B-27	72202584	C-17	72202902	B-12
72202299	B-28	72202586	C-17	72202916	I-1
72202300	B-28	72202587	C-17	72202931	D-4
72202301	B-28	72202588	C-17	72202932	D-4
72202302	B-27	72202589	B-48	72202956	M-2
72202309	D-3	72202594	A-31	72202958	C-1, M-1, M-4
72202310	D-3	72202595	B-3	72202959	C-1, M-1
72202311	A-26	72202597	B-2	72202961	C-1, M-2
72202312	A-26	72202599	B-3	72202962	C-1, M-2
72202315	A-29, A-30	72202600	B-3	72202963	M-2
72202316	A-29	72202602	B-2	72202964	M-2
72202317	A-29, A-30	72202603	B-2	72202971	A-9, A-31, A-50
72202319	A-29	72202605	B-3	72202972	A-31
72202326	A-26	72202606	B-3	72202980	A-6
72202328	N-1	72202608	B-2	72202981	A-6
72202330	N-1	72202610	B-2	72202982	A-6
72202332	N-1	72202611	B-5	72202983	A-6
72202334	N-1	72202612	B-5	72202984	A-6
72202336	N-1	72202613	B-5	72202985	A-6
72202338	N-1	72202615	B-5	72202986	B-12
72202340	N-1	72202616	B-5	72203005	O-2
72202342	N-1	72202618	B-5	72203052	C-17
72202344	N-1	72202619	B-5	72203058	A-42
72202346	N-1	72202620	B-5	72203059	A-42
72202348	N-1	72202621	B-1, B-3, B-4, B-12	72203060	A-42
72202350	N-1	72202622	B-5	72203061	A-42
72202352	N-1	72202623	B-3	72203062	A-42
72202354	N-1	72202624	B-2	72203064	A-42
72202357	B-28	72202625	B-3	72203065	A-42
72202358	B-28	72202626	B-2	72203066	A-42
72202359	B-28	72202628	C-17	72203067	A-42
72202381	P-1	72202629	C-17	72203068	A-42
72202382	P-1	72202630	B-3	72203069	A-42
72202383	P-1	72202631	B-2	72203070	A-42
72202384	P-1	72202633	B-2, B-3	72203071	A-42
72202389	A-59	72202634	B-2, B-3	72203072	A-42
72202397	C-14	72202636	B-28	72203073	A-42
72202403	B-17	72202637	B-28	72203074	A-42
72202404	B-17, B-19, B-20, B-21, C-14, C-16	72202638	B-28	72203075	A-42
72202405	A-44	72202674	A-1	72203076	A-42
72202423	A-33	72202675	A-1	72203077	A-42
72202428	A-19, A-21, A-43, A-66, H-4, Q-3	72202683	C-17	72203078	A-42
72202437	A-33	72202730	B-44	72203080	A-42
72202439	P-2	72202732	C-17	72203081	A-42
72202441	A-29	72202744	A-10	72203085	A-31
72202442	K-12	72202745	A-10	72203086	A-31
72202448	C-7, C-8, K-7, K-8	72202746	A-10	72203087	A-31
72202449	C-7, C-8, K-7, K-8	72202747	A-10	72203090	A-31
72202452	A-29	72202752	A-10	72203091	A-31
72202453	A-29	72202753	A-10	72203093	A-42
72202456	B-8	72202754	A-10	72203095	A-42
72202457	B-8	72202755	A-10	72203096	A-42
72202458	B-8	72202756	A-10	72203103	B-3
72202462	I-1	72202757	A-10	72203104	B-3
72202463	M-7, R-1	72202758	A-10	72203105	B-3

72203127	C-13, F-10	72203374	B-15	6900215Z	K-19
72203128	C-13, F-10	72203375	B-15	6900237Z	K-19
72203129	C-13, F-10	72203378	B-1	6900279Z	K-19
72203130	C-13, F-10	72203379	B-1	6900295Z	K-4
72203131	C-13, F-10	72203380	B-1	6900391Z	K-5
72203132	C-13, F-10	72203388	N-2	6900595Z	J-9
72203133	C-7, K-7	72203389	N-2	7208328Z	M-7, R-2
72203138	D-10, K-13	72203415	B-34	7208334Z	M-7, R-2
72203139	G-3	72203418	N-2	013479Z	A-25
72203140	G-3	72203423	B-15	5510C	O-4
72203156	B-15	72203424	B-15	1080i	N-2
72203159	B-15	72203425	A-32	5600MD	O-4
72203160	B-15	72203426	A-32	1080p	N-2
72203161	A-31	72203427	A-32	1200p	N-2
72203162	A-31	72203428	A-32	4139Z	D-14, D-16, M-6
72203163	A-31	72203429	A-32	460H	O-5
72203164	A-31	72203430	A-32	470H	O-6
72203165	A-31	72203431	A-32	560H	C-1, M-1, N-1, O-6
72203166	A-31	72203432	A-32	660HD	O-1
72203167	A-31	72203433	A-32	110MD	O-2
72203168	A-31	72203434	A-32	450P	5
72203170	A-31	72203435	A-32	460P	5
72203177	I-5	72203436	A-32	560P	N-1, 5
72203178	I-5	72203437	A-32	100W	P-2
72203179	I-5	72203438	A-32	180W	P-2
72203180	I-5	72203439	A-32	250W	P-2
72203181	I-5	72203440	A-32	300W	P-1, P-2
72203182	I-5	72203441	A-32	300XL	P-2
72203183	I-5	72203442	A-32	420XL	P-2, P-4
72203184	I-5	72203443	A-32	500XL	N-1, P-1, P-2
72203185	I-5	72203444	A-32	325Z	O-7
72203186	I-5	72203445	A-32	51MD	O-4
72203187	I-5	72203446	A-32	55MD	O-3, O-4
72203189	I-5	72203447	A-32	63rd	B-2
72203190	I-5	72203448	A-32	4BNC	O-7
72203191	I-5	72203450	A-32	3CCD	N-2
72203203	A-39, N-3	72203451	A-32		
72203204	A-39, N-3	72203452	A-32		
72203226	B-44	72203453	A-32		
72203228	C-17	72203454	A-32		
72203235	A-69, D-4	72203459	B-15		
72203236	A-69, D-4	72203460	B-15		
72203238	A-69, D-4	72203482	B-1		
72203239	A-69, D-4	72203483	B-1		
72203244	A-42	72203484	B-15		
72203245	A-42	72203485	B-15		
72203246	A-42	72203516	B-31		
72203247	A-42	72203517	B-31		
72203252	A-31	72203519	F-1		
72203253	A-31	72203520	F-2		
72203254	A-31	72203521	F-2		
72203255	A-31	72203522	F-2		
72203256	A-31	72203536	D-10, K-13		
72203260	A-39, N-3	72203565	B-31		
72203280	B-15	72203594	G-3		
72203281	B-15	72203612	D-5		
72203290	B-15	72203613	D-7, J-11		
72203291	B-15	72203624	D-10, K-13		
72203298	B-15	72203625	D-10, K-13		
72203299	A-69, B-30, B-31, C-5, D-3, D-4	72203642	A-42		
72203300	A-69, B-30, B-31, C-5	72203700	O-2		
72203301	A-69, B-30, B-31, C-5	72203701	O-2		
72203307	C-8, J-13	72203702	O-2		
72203308	C-8, J-13	72210558	B-35		
72203316	A-42	73303518	F-1		
72203318	B-34	81010296	M-1, O-6		
72203326	C-1, C-7, K-7	90500817	O-1		
72203327	C-1, C-7, K-7	90502965	O-2		
72203328	C-1, C-7, K-7	90504109	O-2		
72203329	C-1, C-7, K-7	90504533	O-2		
72203330	A-7	91000268	L-2		
72203331	A-6	91000290	L-2		
72203335	B-1	91000973	G-3		
72203336	B-1	91001639	P-1		
72203360	N-2	6900022Z	K-19		
72203361	N-2	6900084Z	K-19		
72203362	D-8, K-9	6900092Z	K-19		
72203372	B-15	6900106Z	K-19		
72203373	B-15	6900167Z	K-19		





560H Camera Head ..... N-1  
 660HD Image Management System  
     O-1  
 560P Camera Control Unit ..... N-1  
 500XL Light Source ..... I-1, L-1, L-2, Q-4

## A

Abrader ..... C-13, C-18, D-11, D-12, F-9, F-10,  
     F-11, F-12  
 Access 15 Irrigation System ..... L-4  
 Access 15 Optional Accessories ..... L-4  
 Access Disposable Cannulas ..... B-39, B-40,  
     K-14, K-15  
 Accessories for Autoclavable Endoscopes  
     M-8, R-2  
 Accessory Control Cable ..... O-7  
     Accessory Control Cable, RCA to mini-  
     phono ..... O-7  
 ACL ..... A-6, A-7, A-8, A-9, A-10, A-11, A-12,  
     A-13, A-14, A-15, A-16, A-17, A-18, A-19,  
     A-20, A-21, A-22, A-23, A-24, A-25, A-26,  
     A-27, A-28, A-29, A-31, A-32, A-33, A-34,  
     A-35, A-36, A-37, A-38, A-39, A-40, A-41,  
     A-42, A-43, A-44, A-45, A-46, A-47, A-48,  
     A-49, A-50, A-51, A-52, A-53, A-54, A-55,  
     A-56, A-57, A-58, A-59, A-60, A-61, A-62,  
     A-63, A-64, A-65, F-1, F-4, I-7, J-16, N-3,  
     Q-1  
 ACL Arthroplasty Instruments ..... A-54, A-55,  
     A-56  
 ACL REDUX Revision System ..... Q-1  
 ACROMIOBLASTER ..... F-9  
 Acromionizer ..... F-9  
 ACUFEX ..... A-23, A-24, A-26, A-32, A-33,  
     A-34, A-35, A-36, A-37, A-38, A-39, A-41,  
     A-45, A-46, A-47, A-49, A-56, A-59, A-60,  
     B-43, B-46, B-50, C-17, D-5, D-7, J-1, J-2,  
     J-3, J-4, J-5, J-6, J-8, J-9, J-10, J-13, J-17,  
     J-18, N-3, Q-1, R-7, xi, xiv, xvi, xvii, xix  
 ACUFEX DIRECTOR APPLICATION Anatomic  
 Guide ..... A-39, N-3  
     ACUFEX DIRECTOR ELITE Bone-Tendon-  
 Bone ACL Drill Guide System ..... A-37  
     ACUFEX DIRECTOR ELITE Rear Entry Drill  
 Guide System ..... A-38  
     ACUFEX DIRECTOR ELITE Rear Entry Drill  
 Guide System ..... A-38  
 ACUFEX DIRECTOR PCL Drill Guide System  
     A-45  
 ACUFEX Knives ..... J-13  
     ACUFEX PINPOINT Anatomic ACL Guide  
 System ..... A-32  
 ACUFEX Pro. C-17, J-1, J-2, J-3, J-4, J-5, J-6,  
     J-8, J-9, J-10, J-17  
 ACUFEX Pro ..... J-9  
 ACUFEX punches ..... J-2  
 ACUFEX scissors ..... J-8  
 Aimers ..... A-46, A-48, A-49, B-49, xix  
 Aluminum oxide ..... M-1, M-5, M-8, R-2  
 Aluminum oxide vial ..... M-1, M-5, M-8, R-2  
 Ankle Distractor Foot Straps ..... D-2  
 ARTHROPAK ..... A-71, B-51, C-19, D-22, K-21,  
     L-5  
 Arthroscopes C-1, C-6, D-10, D-14, K-2, K-5,

K-6, K-11, K-12, K-13, M-4, M-6, P-3, Q-3  
 arthroscopic capsular release ..... B-50  
 Arthroscopic Electrodes ..... I-17  
 Autoclavable Arthroscope Sterilization Tray  
     Q-3  
 Automatic Pin Collet ..... H-6  
 Automatic Wire Driver ..... H-6

## B

Banana ..... C-8, C-17, J-13  
 Barrel Abrader ..... D-12, F-12  
 Basket Punches ..... C-9, J-1, J-3, J-4, J-5, J-6  
 BICEPTOR Tenodesis System ..... B-27  
     BIORAPTOR 2.9 AB Suture Anchor with  
     Needles ..... B-21  
 BIORAPTOR 2.9 Suture Anchors ..... B-20  
 BIORAPTOR Knotless Suture Anchor  
     B-17, C-14  
 BIORCI Screws ..... A-14  
 BIOSURE PK Interference Screws ..... A-10, A-11  
 BIOSURE SYNC Tibial Fixation Device ..... A-10  
 Bipolar Ablation Probes ..... I-8  
 Blade Retention Screws ..... J-7  
 Blades ..... C-13, D-11, D-12, F-1, F-2, F-3, F-4,  
     F-5, F-6, F-7, F-8, F-10, F-11, F-12, F-13, G-2,  
     H-3, H-4, H-7, H-8, I-13, J-7, K-16, Q-3, R-6,  
     xvii, xix  
 Blunt Dissector ..... D-15, D-16, D-17, D-18, D-19  
 Blunt Nose Jr. Punch ..... D-5, J-11  
 Boat Nose Obturator ..... D-16, D-17, D-18, D-19  
 BONECUTTER. C-13, D-11, D-12, F-1, F-3, F-4,  
     F-10, F-11, F-12, I-13, xi  
 Bone Tunnel Plugs ..... A-57  
 Burrs ..... C-13, D-11, D-12, F-9, F-10, F-11, F-12,  
     F-13, G-2

## C

Calibrated Sagittal Saw Blades ..... H-8  
 camera head ..... M-2, M-3, N-1, N-2, O-3  
 Cannulae ..... B-10, K-1, K-18, K-19  
 Cannula, Operative ..... D-15, K-19  
 Cannulas ..... A-22, B-39, B-40, B-42, C-1, C-6,  
     C-7, C-8, C-14, D-8, D-9, D-10, K-1, K-2,  
     K-3, K-4, K-5, K-6, K-7, K-11, K-12, K-13,  
     K-14, K-15, K-16, K-17, K-20, L-2, xvii, xix  
 Cannulas and Obturators ..... C-7, K-7  
 Cannulas for Use with Arthroscopes  
     K-13  
 Cannulated Drill Bits ..... A-50, A-59  
 Cannulated Tissue Tensioner ..... B-26, B-49,  
     J-10  
 Carpal Tunnel. D-14, D-16, D-17, D-18, D-19,  
     D-21  
 Carpal Tunnel Endoscope ..... D-17, D-19  
 Carpal Tunnel Ligament Repair ..... D-17, D-18,  
     D-19, D-21  
 Carpal Tunnel VideoEndoscope. D-14, D-16,  
     D-17, D-19

Chondral Picks ..... A-68, J-12  
 CLANCY Anatomic Cruciate Guide  
     A-31  
 CL Device ..... A-8, A-9  
 Cleaning Brushes ..... J-7  
     CLEAR-TRAC COMPLETE Disposable  
 Cannula System ..... B-39, K-14  
 CLEAR-TRAC Screw Cannula ..... A-22, A-62,  
     A-65, K-16  
 CLEAR-TRAC Threaded Cannula... B-41, K-16  
     CLEAR-TRAC Threaded Cannula with  
 Obturator ..... K-16  
 color printing pack ..... O-4  
 COMPACTION Pliers ..... A-28, A-42  
 Conical Obturator ..... D-9, D-16, D-17, D-18,  
     D-19, K-18  
 Corded Power Equipment ..... H-4, H-5  
 Cotton-Tipped Applicators ..... D-16  
 CROSSTRAC Hip Guide System ..... C-6  
 Cruciate Accessory Pacs. A-61, A-62, A-63,  
     A-64, A-65  
 Cruciate Pins and Wires ..... A-59, A-60  
 Curette ..... A-34, A-35, A-36, A-37, A-38,  
     A-45, A-54, A-56, C-17, D-5, J-12  
 Curettes ..... A-54, J-12, xix  
 Curved Crile ..... R-7  
 Cystourethroscopes ..... M-6, M-9, R-3

## D

DB9-RCA Remote Cable ..... O-7  
 Diagnostic Cannula C-1, D-9, K-1, K-10, K-11,  
     K-19, M-5  
 Diagnostic Cannula Sets ..... K-1  
 Diagnostic Cannulas, Extended Length  
     C-1, K-11  
 Diamond Rasps ..... A-5  
 Dilators ..... A-10, A-53, A-66, A-67, xix  
 Direct-View D-14, M-4, M-5, M-6, M-7, M-8,  
     M-9, Q-3, R-1, R-2, R-3  
 Direct-View Arthroscopes ..... M-4  
 Direct-View Arthroscopes, Autoclavable  
     M-4  
 Direct-View Autoclavable Hysteroscopes  
     M-9, R-3  
 Direct-View Autoclavable Laparoscopes  
     M-7, R-1  
     Direct-View Operative Laparoscope  
 Accessories ..... M-8, R-2  
 Direct-View Operative Laparoscopes  
     M-8  
 Disposable Cannula Sets with Distal Holes  
     K-17  
     Disposable Cannula Sets without Distal  
 Holes ..... K-17  
 Disposable knives ..... D-21, J-13, K-15  
     Disposable Saw Blades for DYONICS  
 POWER Instrumentation ..... H-7  
 Dissecting Obturator ..... D-16, D-17, D-18, D-19  
 Dissectors ..... R-7  
 Dolphin Nose ..... R-7  
     DOUBLE-SPIKED PLATE Tibial Fixation  
 System ..... A-26  
 Drill ..... A-9, A-17, A-24, A-25, A-26, A-31,

- A-32, A-33, A-34, A-35, A-36, A-37, A-38, A-39, A-40, A-41, A-42, A-43, A-44, A-45, A-46, A-47, A-48, A-49, A-50, A-51, A-52, A-53, A-54, A-55, A-56, A-57, A-58, A-59, A-60, A-61, A-62, A-63, A-64, A-65, A-66, A-67, B-1, B-2, B-3, B-4, B-8, B-9, B-10, B-11, B-12, B-13, B-15, B-16, B-17, B-18, B-19, B-20, B-21, B-22, B-24, B-25, B-27, B-28, B-50, C-14, C-15, C-16, D-1, D-6, D-14, E-3, H-1, H-4, H-5, H-6, N-3, Q-1, xix  
Drill Bits Single Flute..... A-51  
Drill Guide ..... A-24, A-26, A-31, A-32, A-33, A-34, A-35, A-36, A-37, A-38, A-39, A-40, A-41, A-42, A-43, A-44, A-45, A-46, A-47, A-48, A-49, A-50, A-51, A-52, A-53, A-54, A-55, A-56, A-57, A-58, A-59, A-60, A-61, A-62, A-63, A-64, A-65, A-66, A-67, B-9, B-10, B-11, B-15, B-16, B-17, B-18, B-19, B-20, B-21, B-22, B-24, B-25, C-14, C-15, C-16, D-1, D-6, N-3, Q-1  
Dual Action Atraumatic (rotatable) R-8  
Dual Action Retraction Forceps (rotatable) R-8  
DUCKLING ..... C-9, J-2, J-4, J-16, J-17, xi  
DYONICS A-41, A-71, B-51, C-11, C-12, C-13, C-19, D-11, D-12, D-22, F-1, F-2, F-3, F-4, F-5, F-6, F-7, F-8, F-9, F-10, F-11, F-12, F-13, G-1, G-2, G-3, G-4, H-1, H-4, H-5, H-6, H-7, I-1, I-2, I-3, I-4, I-5, I-7, I-10, I-13, I-14, I-15, K-2, K-11, K-12, K-21, L-1, L-2, L-3, L-5, xi, xix  
DYONICS 25 Carts ..... L-3  
DYONICS 25 Fluid Management System L-1, L-2  
DYONICS 25 Fluid Management System Control Unit ..... L-1  
DYONICS 25 Fluid Management System Tube Sets ..... L-2  
DYONICS 25 Inflow ..... L-2  
DYONICS 25 Luer-to-Colder Adaptor L-2  
DYONICS 25 Patient Tube Set ..... L-2  
DYONICS BONECUTTER Blades ..... F-4  
DYONICS Curved Blades ..... F-6  
DYONICS GLIDER Articular Cartilage Probe C-12, I-15  
DYONICS HIGH VISIBILITY Hip Burrs C-13, F-10  
DYONICS ORBIT Curved Blades ..... F-5  
DYONICS PLATINUM Series Blades F-1  
DYONICS POWER II Shaver System G-1  
DYONICS POWER Instrumentation H-7  
DYONICS POWERMAX ELITE Handpiece G-2  
DYONICS POWERMAX ELITE Handpiece F-9  
DYONICS POWERMINI Burrs ..... D-11, F-11  
DYONICS POWERMINI Shaver Blades D-11, F-11  
DYONICS POWER Synthes chuck ..... H-5  
DYONICS POWER Ultralight Handpiece F-5, G-2  
DYONICS RF ABLATION 90° Probe I-3, I-5  
DYONICS RF BROADNOSE 90° Probe I-3, I-5  
DYONICS RF CONTRACT 30° Probe I-3, I-5  
DYONICS RF CURVE 45° Probe ..... I-3, I-5  
DYONICS RF probes ..... I-2, I-4  
DYONICS RF ROUND 60° Probe ..... I-3, I-5  
DYONICS RF-S CROSS 50° Probe ..... I-3, I-5  
DYONICS RF-S DYNAMO 90° Probe I-3, I-5  
DYONICS RF SLICE 20° Probe ..... I-3, I-5  
DYONICS RF System ..... I-1, I-2, I-3, I-4, I-5  
DYONICS RF System ..... I-1  
DYONICS RF System Bipolar Probes I-3, I-5  
DYONICS sagittal saw blade ..... H-7  
DYONICS Straight Blades ..... F-7, F-8
- ## E
- ECTRA II Disposable Kit ..... D-21  
ECTRA II Disposable Kit ..... D-21  
ECTRA II Obturator Set ..... D-18, D-19  
ECTRA II Obturator Set ..... D-18, D-19  
ECTRA II System ..... D-16, D-17, D-18  
ECTRA II System ..... D-16, D-17, D-18  
ECTRA II System without Endoscope D-18  
ECTRA II System without Endoscope D-18  
Elbow Joint Positioners ..... B-36  
ELECTROBLADE ..... F-3, I-7, I-13, xi  
ELECTROBLADE Resector ..... F-3, I-13  
ELITE PREMIUM II Shoulder Arthroscopy System ..... B-47  
ELITE PREMIUM Instability System ..... B-24  
ELITE PREMIUM Shoulder Instruments B-48  
ENDOBUTTON CL BTB Fixation Device A-7  
ENDOBUTTON CL Pac ..... A-64  
ENDOBUTTON CL Pac ..... A-64  
ENDOBUTTON CL ULTRA Fixation device A-6  
ENDOBUTTON DIRECT Fixation Device A-6  
Endocouplers ..... O-5, O-6  
ENDO-FIX L Screw System ..... A-18  
endoscopes . M-6, M-8, O-5, P-3, P-4, Q-3, R-2  
Endoscopic Cannulated Drill Bits ..... A-50  
Extremity Cannula Sets ..... K-9, K-10  
Extremity Cannula Sets ..... K-9, K-10  
Extremity Radiofrequency Probes ..... I-16
- ## F
- Face Shields ..... Q-4  
FAST-FIX 360 meniscal repair system A-1  
Fine Tip ..... R-7  
Fixation Post Instrument System ..... Q-1  
flexor tendon release ..... D-15  
Fluid Barrier Boots ..... Q-4  
Fluid Management System ..... L-1, L-2, L-3  
FOOTPRINT PK Suture Anchor ..... B-13  
FOOTPRINT PK Suture Anchor ..... B-13  
FOOTPRINT Ultra PK Suture Anchor B-12  
Fracture Support Table ..... Q-5  
Full Radius ..... C-13, D-11, D-12, F-2, F-3, F-4, F-5, F-6, F-7, F-8, F-10, F-11, F-12, I-13  
Full Radius ELITE ..... F-5, F-6, F-8
- ## G
- Gemini Universal 4 mm Fiber Optic Light Cables without Adaptor ..... P-3  
Gemini Universal 5 mm Fiber Optic Light Cables without Adaptor ..... P-3  
Gemini Universal Fiber Optic Light Cables with Adaptors ..... P-3  
Gloss Photo Paper ..... O-4  
Graft Harvesting ..... A-28, A-29, A-30, A-67  
Graft Sizing Tubes ..... A-53  
Graft Sleeve ..... A-27  
Graspers ..... J-1, J-9, J-10, J-11, J-16, R-8  
Guhl Non-Invasive Ankle Distractor D-2  
Guhl Non-Invasive Ankle Distractor Sterilization Tray ..... D-2  
Guhl Non-Invasive Ankle Distractor System D-2
- ## H
- Hand Holder ..... D-16, D-17, D-18, D-19, Q-2  
Hand Holder and Sterilization Tray with Cover ..... D-16, D-17, D-18, D-19, Q-2  
Hand Instruments ..... C-8, C-9, C-10  
HAND INSTRUMENTS ..... xix  
Handle... A-12, A-15, A-19, A-21, A-26, A-31, A-32, A-33, A-34, A-35, A-36, A-37, A-40, A-45, A-48, A-49, A-68, B-5, B-16, B-21, B-22, B-35, B-44, B-45, B-47, B-48, B-49, C-1, C-6, C-7, C-8, C-9, C-11, C-17, C-18, D-1, D-7, D-16, D-17, D-18, D-19, E-3, F-13, I-14, J-1, J-4, J-6, J-8, J-9, J-13, J-14, J-16, J-17, K-7, R-5, R-6  
Handle with Electrosurgical Post ..... R-5, R-6  
Hand Strap ..... D-16, D-17, D-18, D-19  
HD1200 Autoclavable Camera System N-2, xix  
HEALICOIL® PK Suture Anchors ..... B-1  
HEALICORE Trephine System ..... A-42  
High-Grade R-VHS (R-video) Cable O-7  
High-Grade R-VHS (R-video) Cable O-7

O-7  
 Hip Arthroscopy ..... C-1, C-5, C-7, C-8, C-9,  
 C-10, C-11, C-17, I-14, K-7, K-8, K-11, M-5,  
 Q-2  
 Hip Positioning System ..... C-2, C-3  
 Hip Repair ..... C-17  
 Hip Shaver Blades and Burrs ..... C-13, F-10  
 Hook ..... A-45, A-56, B-46, B-47, B-49, C-12,  
 C-17, I-3, I-5, I-12, I-15, I-16, J-12, J-13, J-14,  
 R-6  
 Housing Tube ..... R-5, R-6  
 Hystereoscopic Sheaths ..... M-9, R-3  
 Hysteroscopes ..... M-6, M-9, R-3

## I

INCISOR Plus. C-13, D-11, D-12, F-1, F-5, F-6,  
 F-8, F-10, F-11, F-12  
 INCISOR Plus ELITE C-13, D-11, F-6, F-8, F-10,  
 F-11  
 Inflow cap ..... K-12  
 Infusion Adaptor ..... D-8, K-2, K-5, K-6, K-9  
 Inline Sagittal Saw ..... H-4  
 Inner Assembly ..... R-5  
 INTERCEPTRE laparoscopic instruments  
 R-5  
 Irrigation Extender.. D-8, K-3, K-5, K-8, K-9,  
 K-19  
 Irrigation Extenders . C-7, C-8, K-3, K-7, K-8,  
 K-16, K-19  
 ISO-PAC ..... A-65  
 ISOTAC System ..... A-58  
 ISOTAC System ..... A-58

## J

Jacobs Chuck Key ..... H-2  
 Jacobs Chuck, keyless, 1 ..... H-6

## K

KINSA RC Suture Anchor ..... B-14  
 Knives ..... C-8, D-16, D-21, J-13, K-15, xix  
 K-Wire Guide ..... D-6

## L

Laparoscope ..... M-8, R-2  
 Laparoscopes.. M-6, M-7, M-8, P-3, R-1, R-2  
 Laparoscopic Instruments ..... R-5, R-7, R-8  
 Large Sterilization Tray with mat ..... A-3, Q-1,  
 Q-3

LIGAMENT CHISEL Probe C-12, I-12, I-15, I-16  
 LIGAMENT CHISEL Probe ..... I-12  
 Light post Adaptor Sleeve ..... M-6  
 Light Source Replacement Parts ..... P-2  
 Limb Positioners.. B-30, B-32, C-5, D-3, D-4  
 Linear Instrument ..... Q-1  
 Linear Instruments Fifteen-unit Sterilization  
 Tray ..... J-15

## M

Maryland ..... R-7  
 Medium Sterilization Tray with mat  
 Q-1, Q-3  
 Meeker ..... R-7  
 Meniscal Repair Systems A-1, A-2, A-3, A-4,  
 A-5  
 Meniscal Stitcher ..... A-4, Q-1  
 Meniscectomy ..... I-7, J-2, J-13  
 Meniscus Mender II ..... A-3, Q-1  
 Micro ABLATOR Probe ..... I-9, I-16  
 Micro ABLATOR-S Probe ..... I-9, I-16  
 Micro Instruments ..... D-7, Q-2  
 Micro Instrument System ..... D-7  
 Micro LIGAMENT CHISEL Probe ..... I-12, I-16  
 MicroPunch ..... D-7, J-11  
 Micro TAC-S Probe ..... I-11  
 Micro TAC-S Probe, angled ..... I-11  
 MICRO VECTOR Drill Guide ..... D-6  
 Mini TAC-S Probe ..... I-11  
 MONITORS ..... O-2, xix  
 Monopolar Ablation Probes ..... I-9  
 Monopolar Hip Probes... C-11, C-12, I-14, I-15  
 MOSAICPLASTY Precision System  
 A-66, A-67, Q-1  
 Motor Drive Cord ..... G-4  
 MPC IV Charger ..... H-2

## N

Non-Autoclavable Endocouplers ..... O-5  
 Non-Invasive Ankle Distractor ..... D-2, Q-2  
 NOTCHMASTER ..... A-34, A-35, A-36, A-37,  
 A-38, A-54, J-12, xi

## O

Obturator.. A-2, A-40, B-15, B-16, B-17, B-18,  
 B-19, B-20, B-24, B-25, B-39, B-40, B-41,  
 C-1, C-6, C-7, C-10, C-14, C-15, C-16, C-18,  
 D-8, D-9, D-10, D-15, D-16, D-17, D-18,  
 D-19, E-3, F-13, K-1, K-4, K-5, K-6, K-7, K-9,  
 K-10, K-11, K-12, K-13, K-14, K-15, K-16,  
 K-17, K-18, K-19, M-5  
 Obturator Handle ..... D-16, D-17, D-18, D-19,  
 F-13  
 Obturators .... B-39, B-40, C-7, C-8, E-3, K-1,

K-2, K-3, K-4, K-5, K-6, K-7, K-14, K-15,  
 xvii, xix  
 OBTURATORS and TROCARS ..... K-4, xix  
 Offset Drill Guide ..... D-6  
 Offset Guides ..... A-48  
 Olive Tip ..... R-7  
 Operative Cannula . D-8, D-9, K-2, K-5, K-6,  
 K-9, K-10  
 Operative Cannula Sets ..... K-5, K-6  
 ORBIT Curved Blades ..... F-5  
 ORBIT Full Radius ..... F-5  
 ORBIT INCISOR ..... F-5  
 ORBIT INCISOR Plus ..... F-5  
 ORBIT RAZORCUT ..... F-5  
 ORBIT SYNOVATOR ..... F-5  
 O-ring . G-4, K-1, K-11, K-20, M-1, M-2, M-6,  
 O-5, O-6  
 O-rings ..... F-13, K-20  
 OSTEORAPTOR Curved Suture Anchors and  
 Guide System ..... B-15  
 Osteotome ..... A-54, D-5, xix  
 Outer Tube ..... R-5, R-6  
 Outflow Cannula Set ..... K-4  
 Oval Punches ..... J-4, J-16

## P

Pac II Battery ..... H-2  
 Palmar Arch Suppressor .... D-16, D-17, D-18,  
 D-19  
 Patellar Tendon Saw Guides ..... A-28  
 Patient Positioning .. A-69, B-30, B-31, B-32,  
 B-33, B-34, B-35, B-36, B-37, B-38, C-2,  
 C-3, C-4, C-5, D-2, D-3, D-4  
 Personal Protection Items ..... Q-4  
 Pistol Grip Drill ..... H-4  
 PITBULL ..... C-9, J-9, J-11, J-16, J-17, xi  
 plain paper printer ..... O-3  
 Polymer Anchors... B-6, B-7, B-8, B-13, B-14,  
 B-16, B-20, B-21, B-22, B-25  
 Portal Accessory System ..... B-41, B-42  
 Posterior Punches ..... J-5  
 power cable ..... C-11, H-6, I-14  
 power cord ..... G-1, G-4, I-1, I-5, I-6, L-1, L-2,  
 L-4, N-1, O-1  
 Printer Accessories ..... O-4  
 Probe .. A-1, A-2, A-9, A-29, B-47, C-8, C-11,  
 C-12, D-5, D-7, D-8, D-15, D-16, D-17, D-18,  
 D-19, D-21, I-2, I-3, I-4, I-5, I-6, I-7, I-8, I-9,  
 I-10, I-11, I-12, I-14, I-15, I-16, I-17, J-12, K-9,  
 Q-2  
 Probes .... C-11, C-12, I-1, I-2, I-3, I-4, I-5, I-6,  
 I-7, I-8, I-9, I-11, I-12, I-14, I-15, I-16, I-17,  
 J-12, J-14, xvii, xix  
 Probe Tip Bender ..... I-6  
 Protective cap for autoclavable scopes  
 M-1, M-5, M-8, R-2  
 Punches . C-9, J-1, J-2, J-3, J-4, J-5, J-6, J-7,  
 J-8, J-11, J-16

## R

Radiofrequency System ..... I-1  
Ragnell Retractor ..... D-16, D-17, D-18, D-19  
RAPTORMITE 3.7 mm Suture Anchor  
D-1  
RAPTOR ..... C-9, D-5, J-9, J-11, J-16, xi  
RAZORCUT ..... D-11, D-12, F-5, F-7, F-11, F-12  
RCI screws ..... A-9, A-16, A-50  
RCI Screws ..... A-16  
Replacement Arc Lamp High-Voltage Cable  
Assembly for AutoBrite ..... P-2  
Replacement Blades ..... J-7  
Replacement Lamp for DYOSITE II ..... P-2  
Replacement Lamps ..... P-2  
Replacement Loop Adaptor ..... D-2  
Replacement Metal Halide Arc Lamp  
P-2  
Replacement rubber mat for Sterilization  
Tray ..... Q-3  
Replacement Stopcock ..... M-8  
Replacement Xenon Lamp ..... P-2  
Replacement Xenon Lamp Module  
P-2  
Replacement Xenon XL Lamp Module  
P-2  
Reusable Cannulas ..... K-11, K-12  
RGB Cable ..... O-7  
RGB Cable ..... O-7  
Rongeur ..... C-9, J-9, J-16  
Rosette ..... J-13  
Rotary Scissors ..... J-8  
Rotatable Operative Cannula ..... K-5  
Rotator Cuff Soft Tissue Fixation ..... B-1, B-2,  
B-3, B-4, B-5, B-6, B-7, B-8, B-9, B-10, B-11,  
B-12, B-13, B-14  
RS232 Data Cable ..... O-7

## S

Sagittal Saw ..... H-1, H-3, H-4, H-6, H-7, H-8  
Sagittal Saw Blades ..... H-7, H-8  
Sagittal Saw Blades with Depth Stops  
H-7  
Sagittal Saw Module ..... H-4  
SAPHYRE II Bipolar Ablation Probes  
I-8  
Saw Blade ..... H-3, H-7, H-8  
Saw Blades ..... H-3, H-7, H-8  
Scissors ..... B-49, J-1, J-8, J-16, J-17, R-5, R-6  
Scissors Blade ..... R-6  
Scissors Punches ..... J-8  
Shaver Handpieces ..... G-2, G-3  
Shaver Interface Cable ..... L-1, L-2  
Short Sheath and Obturator Components  
F-13  
Single Action Atraumatic ..... R-8  
Single Action Retraction Forceps ..... R-8  
Single-use Extremity Blades and Burrs  
F-11, F-12, G-2  
Slotted Cannula ..... A-1, C-7, D-16, D-17, D-18,  
D-19, I-10, K-7  
Small Joint Arthroplasty System ..... D-5

Small Joint Arthroplasty System Sterilization  
Tray ..... D-5  
Small Joint Arthroscopes ..... D-14  
Small Joint Arthroscopy System ..... Q-2  
Small Joint Grasper ..... D-5  
Small Sterilization Tray with mat ..... A-26, Q-3  
Smith & Nephew ..... A-7, A-24, A-34, A-35,  
A-36, A-45, A-69, A-71, B-5, B-12, B-15,  
B-25, B-27, B-30, B-51, C-1, C-2, C-14,  
C-19, D-1, D-15, D-16, D-22, E-1, I-1, I-6, I-7,  
I-10, I-11, I-16, J-1, J-8, J-18, K-21, L-4, L-5,  
N-1, N-2, O-2, O-3, O-4, O-6, O-7, P-3,  
P-4, P-5, Q-1, R-4, x, xiii, xiv, xv, xvi, xvii,  
xviii, xix, xxi  
SPIDER2 Limb Positioner ..... A-69, B-30, B-31,  
B-32, C-5, D-3, D-4  
Split Electrode Pads ..... I-6, I-16  
SPYROMITE 2.0 mm ..... D-1  
Sterilization Tray ..... A-1, A-3, A-4, A-15, A-17,  
A-18, A-24, A-25, A-26, A-32, A-34, A-35,  
A-36, A-37, A-38, A-40, A-44, A-45, A-58,  
A-66, B-24, B-41, B-45, B-47, C-17, D-2,  
D-5, D-7, D-15, D-16, D-17, D-18, D-19, E-3,  
G-3, H-4, J-15, K-7, Q-1, Q-2, Q-3  
Sterilization Tray ..... A-66  
Sterilization Tray; holds up to eight Micro  
Instruments ..... D-7  
STONECUTTER ..... F-9, xi  
Storage and Sterilization Trays ..... Q-1, Q-2,  
Q-3  
Storz ..... K-1, K-4, K-19, M-9, P-4, P-5, R-3  
Straight Crile ..... R-7  
suction punch ..... D-5, D-7, J-7  
Supine Accessories ..... C-2  
Supine Hip Positioning System ..... C-2  
Support Bar ..... D-2  
R-USB Cable ..... O-7  
Suture Anchors B-1, B-2, B-3, B-4, B-5, B-6,  
B-7, B-8, B-9, B-15, B-16, B-17, B-18, B-19,  
B-20, B-21, B-22, B-23, B-29, C-14, C-15,  
C-16, C-18, D-1  
Suture Fixation ..... A-26, B-5, B-29  
Suture Passing Instrumentation ..... B-43, B-44,  
B-45, B-46  
Switchpen ..... I-17  
SYNOVATOR ..... F-4, F-5, F-6, F-7, xi

## T

Table Clamp ..... A-70, D-2  
TAC-C II Probe ..... I-11  
TAC-S Probe ..... C-12, I-11, I-15  
TAC-S Probe ..... I-11  
TAC-S Probe, angled ..... I-11  
TAG Arthroscopic System Components  
B-50  
Teardrop punch ..... D-7, J-11  
Temperature Control Monopolar Probes  
I-11  
Tendon Strippers ..... A-28  
Tenodesis System ..... B-27, B-28  
TFCC Mender Disposable Suture System  
D-14  
T-FIX Suture Bar ..... A-2, B-50

Tibial Fixation ..... A-10, A-26, A-42  
Tissue Repair ..... B-10, E-1, E-2, E-3  
Tissue Tensioner ..... B-26, B-49, J-10  
T-MAX System (beach chair positioner)  
B-33  
TMJ ..... D-8, K-9  
Traction Accessory ..... B-31, B-32, B-34, C-5,  
D-3, D-4  
TRE-CORE Trephine System ..... A-43  
Triangular Fibrocartilage Complex ..... D-14  
Trigger Finger Retrograde Knife ..... D-15  
Trigger Finger Sterilization Tray ..... D-15, Q-2  
Trigger Finger System ..... D-15  
Trigger Finger Triangle Knife ..... D-15  
Trocars K-1, K-2, K-3, K-4, K-5, K-6, xvii, xix  
TRUFIT BGS Plug ..... E-1, E-2  
TRUFIT CB Plug ..... E-1  
TRUFIT CB Plug Kits ..... E-1  
TRUKOR Depth Gauge ..... A-8  
TRUREPAIR ..... xi  
TURBOTRIMMER ..... F-8  
TURBOWHISKER ..... D-11, D-12, F-6, F-7, F-11,  
F-12, xi  
TWINFIX Ti QUICK-T Fixation System  
B-10  
TWINFIX Ti QUICK-T Fixation System  
B-10  
TWINFIX Ultra HA Suture Anchors ..... B-2  
TWINFIX Ultra PK Suture Anchors ..... B-3  
TWINFIX Ultra Ti Suture Anchors ..... B-4

## U

ULTRABRAID High Strength Suture  
B-29  
ULTRA FAST-FIX Meniscal Repair System  
A-1  
Ultra Series TURBOWHISKER ..... F-7  
Universal Cannula ..... K-17

## V

Versitip Adaptors ..... P-3, P-4  
Video Couplers and Adapters ..... O-5, O-6  
Video Monitors ..... O-2  
VIDEO MONITORS ..... xix  
VULCAN RF Arthroscopy System ..... I-6  
VULCAN RF System ..... C-11, I-6, I-7, I-8, I-9,  
I-10, I-11, I-12, I-14, I-16

## W

Wrist and Ankle Instruments ..... D-6  
Wrist Tower ..... D-3



Smith & Nephew, Inc.  
150 Minuteman Road  
Andover, MA 01810 USA

[www.smith-nephew.com](http://www.smith-nephew.com)  
T +1 978 749 1000  
US Customer Service: +1 800 343 5717  
International Customer Service: +1 978 749 1140

\*Trademark of Smith & Nephew. Registered  
US Patent and Trademark Office.  
©2010 Smith & Nephew. All rights reserved.  
Printed in USA. 02/12 10600915 Rev. A