

Königsee Implantate

CATALOGUE

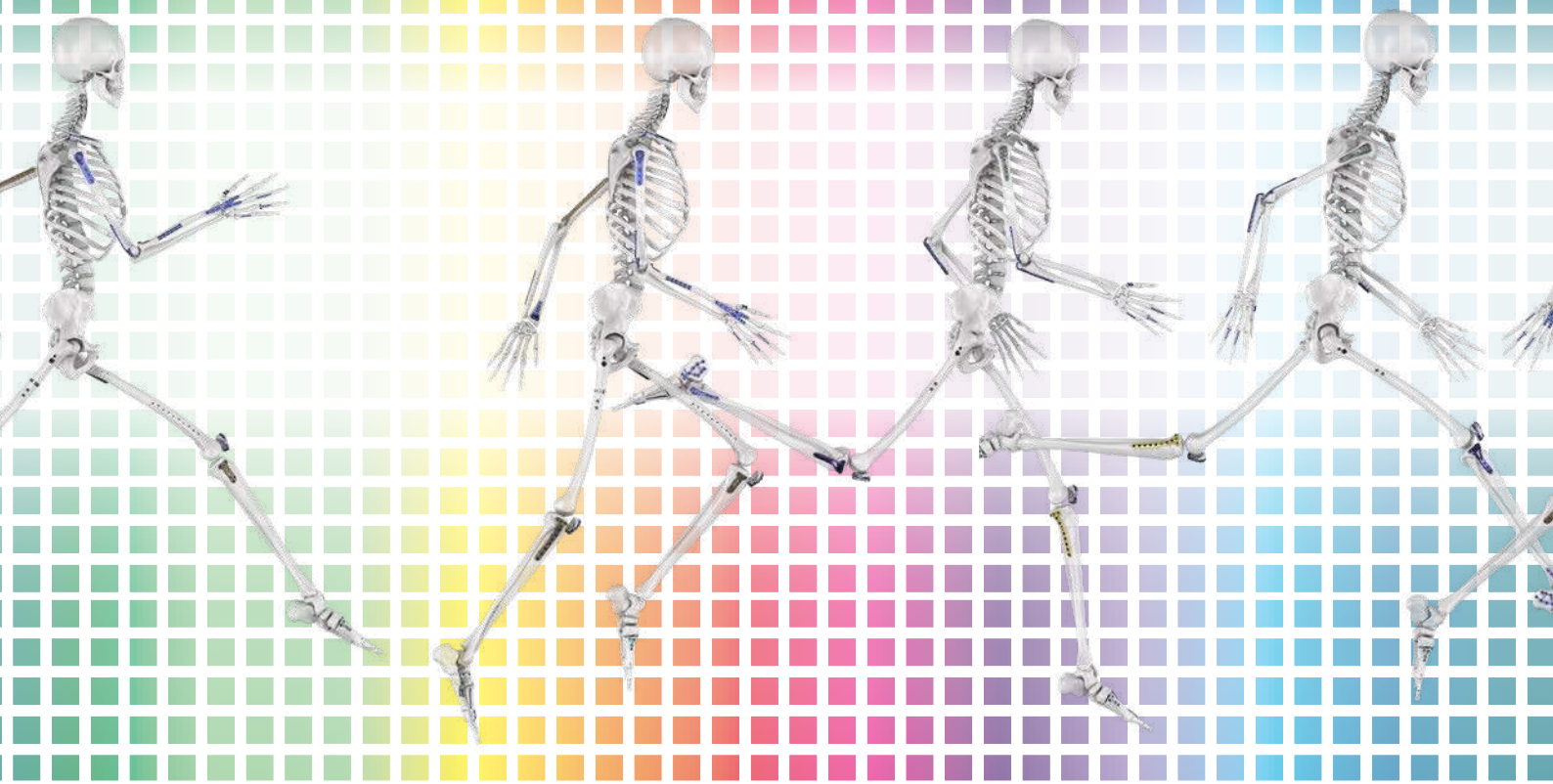

Your Partner in Osteosynthesis

Table of contents

	■	Clavicle
	■	Humerus
	■	Elbow
	■	Radius
	■	Ulna
	■	Hand
	■	Femur
	■	Patella
	■	Tibia
	■	Fibula
	■	Foot
	■	Spine
	■	Periprosthetic
	□	Children
	■	Wires
	■	Cannulated
	■	Screws
	■	Systems
	■	Instruments
	■	Overview

CLAVICLE

Königsee Implantate

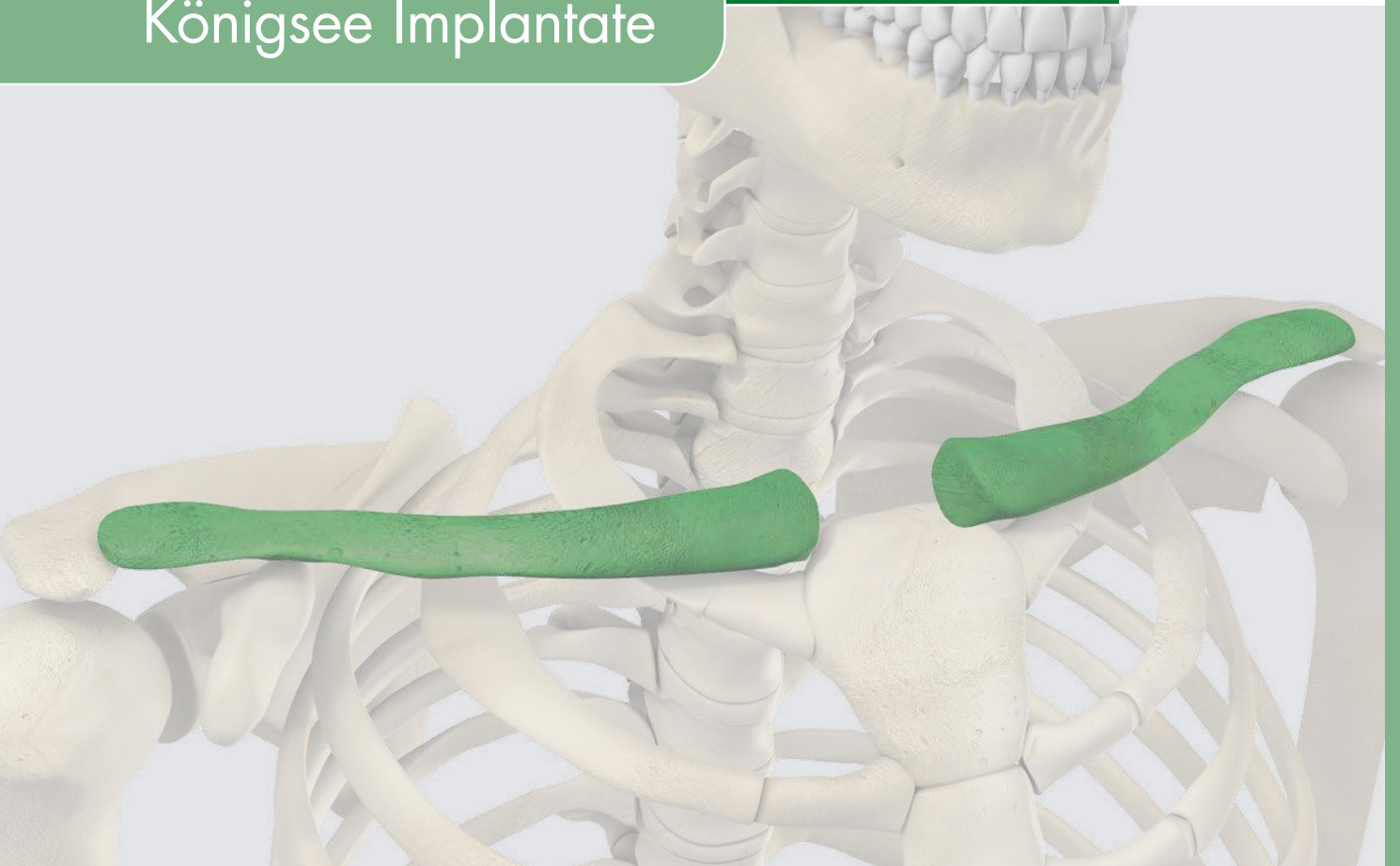

Your Partner in Osteosynthesis

Clavicula Shaft Plate 3.5

angle-stable; for screws \varnothing 3.5 mm; titanium

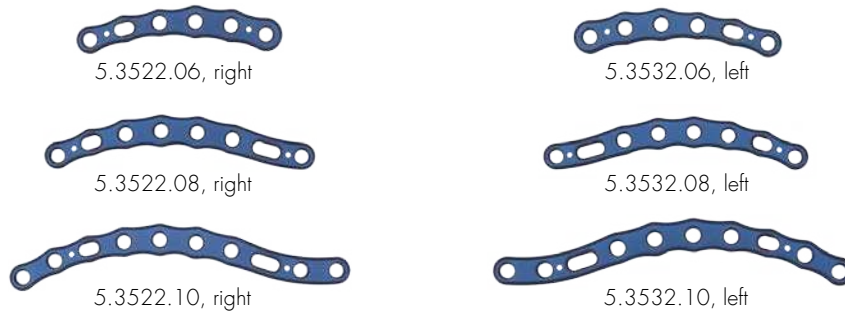

Item no.	Item description
----------	------------------

Angle-stable clavicle shaft plate 3.5; titanium

5.3522.06	Clavicula shaft plate with conical thread 3.5; 6 holes; 74 x 12 mm; right; titanium
5.3522.08	Clavicula shaft plate with conical thread 3.5; 8 holes; 99 x 12 mm; right; titanium
5.3522.10	Clavicula shaft plate with conical thread 3.5; 10 holes; 124 x 12 mm; right; titanium
5.3532.06	Clavicula shaft plate with conical thread 3.5; 6 holes; 74 x 12 mm; left; titanium
5.3532.08	Clavicula shaft plate with conical thread 3.5; 8 holes; 99 x 12 mm; left; titanium
5.3532.10	Clavicula shaft plate with conical thread 3.5; 10 holes; 124 x 12 mm; left; titanium

Clavicula Shaft Plate 3.5 vas

variable angle-stable; for screws \varnothing 3.5 mm; titanium



Item no.	Item description
----------	------------------

Variable angle-stable clavicle shaft plate 3.5; titanium

5.3523.06	clavicle shaft plate with conical thread 3.5; 6 holes; 74 x 12 mm; r 95; vas; right; titanium
5.3523.08	clavicle shaft plate with conical thread 3.5; 8 holes; 99 x 12 mm; r 95; vas; right; titanium
5.3523.09/70	clavicle shaft plate with conical thread 3.5; 9 holes; 107 x 12 mm; r 70; vas; right; titanium
5.3523.09/105	clavicle shaft plate with conical thread 3.5; 9 holes; 111 x 12 mm; r 105; vas; right; titanium
5.3523.10	clavicle shaft plate with conical thread 3.5; 10 holes; 124 x 12 mm; r 95; vas; right; titanium
5.3533.06	clavicle shaft plate with conical thread 3.5; 6 holes; 74 x 12 mm; r 95; vas; left; titanium
5.3533.08	clavicle shaft plate with conical thread 3.5; 8 holes; 99 x 12 mm; r 95; vas; left; titanium
5.3533.09/70	clavicle shaft plate with conical thread 3.5; 9 holes; 107 x 12 mm; r 70; vas; left; titanium
5.3533.09/105	clavicle shaft plate with conical thread 3.5; 9 holes; 111 x 12 mm; r 105; vas; left; titanium
5.3533.10	clavicle shaft plate with conical thread 3.5; 10 holes; 124 x 12 mm; r 95; vas; left; titanium

WiKo® Anterior Clavicle Plate 3.5

medial and lateral; angle-stable; for screws Ø 3.5 mm; titanium; TiOB®



Item no. 5.3802.06



Item no. 5.3812.08

Item no.	Item description
----------	------------------

WiKo® anterior medial clavicle plate 3.5; titanium; TiOB®

5.3802.06	WiKo® anterior medial clavicle plate 3.5; 6 hole; length 80 mm
5.3802.07	WiKo® anterior medial clavicle plate 3.5; 7 hole; length 91 mm
5.3802.08	WiKo® anterior medial clavicle plate 3.5; 8 hole; length 103 mm

WiKo® anterior lateral clavicle plate 3.5; titanium; TiOB®

5.3812.08	WiKo® anterior lateral clavicle plate 3.5; 8 hole; length 105 mm
5.3812.09	WiKo® anterior lateral clavicle plate 3.5; 9 hole; length 117 mm
5.3812.10	WiKo® anterior lateral clavicle plate 3.5; 10 hole; length 128 mm

Information:

The system name WiKo® is derived from the German designation "Winkelstabile Kombination", which translates into English as "angle stable combination". This is a plating technology which offers stable locking at a specified angle.

Products which feature the "®" symbol are registered trademarks of Königsee Implantate GmbH.

Lateral Clavicle Plate 2.7 vas

Variable angle-stable for screws Ø 2.7 mm; titanium



Item no. 5.3603.54, right



Item no. 5.3603.56, right

Item no.	Item description
----------	------------------

Variable angle-stable clavicle plate 2.7; titanium

5.3603.54	Clavicle plate with conical thread 2.7; 5/4 holes; 65 x 10 mm; lateral; vas; right; titanium
5.3603.56	Clavicle plate with conical thread 2.7; 5/6 holes; 82 x 10 mm; lateral; vas; right; titanium
5.3613.54	Clavicle plate with conical thread 2.7; 5/4 holes; 65 x 10 mm; lateral; vas; left; titanium
5.3613.56	Clavicle plate with conical thread 2.7; 5/6 holes; 82 x 10 mm; lateral; vas; left; titanium

Lateral Clavicle Plate 3.5

Angle-stable for screws Ø 3.5 mm; titanium



Item no. 5.3502.34, right



Item no. 5.3502.36, right

Item no.	Item description
Angle-stable clavicle plate 3.5; titanium	
5.3502.34	Clavicle plate with conical thread 3.5; 3/4 holes; 65 x 10 mm; lateral; right; titanium
5.3502.36	Clavicle plate with conical thread 3.5; 3/6 holes; 82 x 10 mm; lateral; right; titanium
5.3512.34	Clavicle plate with conical thread 3.5; 3/4 holes; 65 x 10 mm; lateral; left; titanium
5.3512.36	Clavicle plate with conical thread 3.5; 3/6 holes; 82 x 10 mm; lateral; left; titanium

Lateral Clavicle Plate 3.5 vas

Variable angle-stable for screws Ø 3.5 mm; titanium



Item no. 5.3513.34, left



Item no. 5.3513.36, left

Item no.	Item description
Variable angle-stable clavicle plate 3.5; titanium	
5.3503.34	Clavicle plate with conical thread 3.5; 3/4 holes; 65 x 10 mm; lateral; vas; right; titanium
5.3503.36	Clavicle plate with conical thread 3.5; 3/6 holes; 82 x 10 mm; lateral; vas; right; titanium
5.3513.34	Clavicle plate with conical thread 3.5; 3/4 holes; 65 x 10 mm; lateral; vas; left; titanium
5.3513.36	Clavicle plate with conical thread 3.5; 3/6 holes; 82 x 10 mm; lateral; vas; left; titanium

Clavicula Hook Plates 3.5; straight

Standard; for screws \varnothing 3.5 mm; titanium



Item no. 5.334.04



Item no. 5.339.03

Item no.	Item description
----------	------------------

Standard Clavicula hook plate 3.5; titanium; straight

5.334.04 Clavicle plate 3.5; 4 holes; 88 x 10 mm; straight; titanium

5.334.06 Clavicle plate 3.5; 6 holes; 112 x 10 mm; straight; titanium

Standard Clavicula hook plate 3.5; titanium; straight

5.339.03 Clavicle clasp plate 3.5; 3 holes; 82 x 10 mm; straight; titanium

Clavicula Hook Plates 3.5; straight

Standard; for screws \varnothing 3.5 mm; stainless steel



Item no. 4.334.04

Item no.	Item description
Standard Clavicula hook plate 3.5; stainless steel; straight	
4.334.04	Clavicle plate 3.5; 4 holes; 88 x 10 mm; straight; stainless steel
4.334.06	Clavicle plate 3.5; 6 holes; 112 x 10 mm; straight; stainless steel

Clavicula Hook Plates 3.5

Standard; for screws \varnothing 3.5 mm; titanium



Item no. 5.331.04, left



Item no. 5.332.04, right

Item no.	Item description
Standard Clavicula hook plate 3.5; anatomic rough-bent; titanium	
5.331.03	Clavicula plate 3.5; 3 holes; 75 x 10 mm; anatomic rough-bent; left; titanium
5.331.04	Clavicula plate 3.5; 4 holes; 86 x 10 mm; anatomic rough-bent; left; titanium
5.331.05	Clavicula plate 3.5; 5 holes; 96 x 10 mm; anatomic rough-bent; left; titanium
5.331.06	Clavicula plate 3.5; 6 holes; 106 x 10 mm; anatomic rough-bent; left; titanium
5.331.07	Clavicula plate 3.5; 7 holes; 117 x 10 mm; anatomic rough-bent; left; titanium
5.331.08	Clavicula plate 3.5; 8 holes; 127 x 10 mm; anatomic rough-bent; left; titanium
5.332.03	Clavicula plate 3.5; 3 holes; 75 x 10 mm; anatomic rough-bent; right; titanium
5.332.04	Clavicula plate 3.5; 4 holes; 86 x 10 mm; anatomic rough-bent; right; titanium
5.332.05	Clavicula plate 3.5; 5 holes; 96 x 10 mm; anatomic rough-bent; right; titanium
5.332.06	Clavicula plate 3.5; 6 holes; 106 x 10 mm; anatomic rough-bent; right; titanium
5.332.07	Clavicula plate 3.5; 7 holes; 117 x 10 mm; anatomic rough-bent; right; titanium
5.332.08	Clavicula plate 3.5; 8 holes; 127 x 10 mm; anatomic rough-bent; right; titanium

Clavicula Hook Plates 3.5

Standard; for screws \varnothing 3.5 mm; stainless steel



Item no. 4.331.06, left



Item no. 4.332.06, right

Item no.	Item description
Standard clavicle hook plate 3.5; anatomic rough-bent; stainless steel	
4.331.03	clavicle plate 3.5; 3 holes; 75 x 10 mm; anatomic rough-bent; left; stainless steel
4.331.04	clavicle plate 3.5; 4 holes; 86 x 10 mm; anatomic rough-bent; left; stainless steel
4.331.05	clavicle plate 3.5; 5 holes; 96 x 10 mm; anatomic rough-bent; left; stainless steel
4.331.06	clavicle plate 3.5; 6 holes; 106 x 10 mm; anatomic rough-bent; left; stainless steel
4.331.08	clavicle plate 3.5; 8 holes; 127 x 10 mm; anatomic rough-bent; left; stainless steel
4.332.03	clavicle plate 3.5; 3 holes; 75 x 10 mm; anatomic rough-bent; right; stainless steel
4.332.04	clavicle plate 3.5; 4 holes; 86 x 10 mm; anatomic rough-bent; right; stainless steel
4.332.05	clavicle plate 3.5; 5 holes; 96 x 10 mm; anatomic rough-bent; right; stainless steel
4.332.06	clavicle plate 3.5; 6 holes; 106 x 10 mm; anatomic rough-bent; right; stainless steel
4.332.08	clavicle plate 3.5; 8 holes; 127 x 10 mm; anatomic rough-bent; right; stainless steel

Clavicula Hook Plates 3.5 as

angle stable; for screws \varnothing 3.5 mm; titanium



Item no. 5.3312.04, left



Item no. 5.3322.04, right

Item no.	Item description
Angle stable Clavicula hook plate 3.5; anatomic rough-bent; titanium	
5.3312.04	Clavicula plate with conical thread 3.5; 4 holes; 86 x 10 mm; anatomic rough-bent; left; titanium
5.3312.05	Clavicula plate with conical thread 3.5; 5 holes; 96 x 10 mm; anatomic rough-bent; left; titanium
5.3312.06	Clavicula plate with conical thread 3.5; 6 holes; 106 x 10 mm; anatomic rough-bent; left; titanium
5.3322.04	Clavicula plate with conical thread 3.5; 4 holes; 86 x 10 mm; anatomic rough-bent; right; titanium
5.3322.05	Clavicula plate with conical thread 3.5; 5 holes; 96 x 10 mm; anatomic rough-bent; right; titanium
5.3322.06	Clavicula plate with conical thread 3.5; 6 holes; 106 x 10 mm; anatomic rough-bent; right; titanium

Balzer Plate 3.5

Standard; for Screws \varnothing 3.5 mm; Titanium



Item no.	Item description
offset 21	
5.330.02	Balzer plate 3.5; 2 holes; 68 x 12 mm; offset 21; right; titanium
5.330.03	Balzer plate 3.5; 3 holes; 78 x 12 mm; offset 21; right; titanium
5.330.04	Balzer plate 3.5; 4 holes; 86 x 12 mm; offset 21; right; titanium
5.333.02	Balzer plate 3.5; 2 holes; 68 x 12 mm; offset 21; left; titanium
5.333.03	Balzer plate 3.5; 3 holes; 78 x 12 mm; offset 21; left; titanium
5.333.04	Balzer plate 3.5; 4 holes; 86 x 12 mm; offset 21; left; titanium
offset 11/17	
5.336.02/14	Balzer plate 3.5; 2 holes; 61 x 12 mm; offset 11; right; titanium
5.336.03	Balzer plate 3.5; 3 holes; 71 x 12 mm; offset 17; right; titanium
5.336.04	Balzer plate 3.5; 4 holes; 80 x 12 mm; offset 17; right; titanium
5.337.02/14	Balzer plate 3.5; 2 holes; 61 x 12 mm; offset 11; left; titanium
5.337.03	Balzer plate 3.5; 3 holes; 71 x 12 mm; offset 17; left; titanium
5.337.04	Balzer plate 3.5; 4 holes; 80 x 12 mm; offset 17; left; titanium

Balzer Plate 3.5

Standard; for Screws \varnothing 3.5 mm; Stainless Steel



Item no.	Item description
----------	------------------

offset 10/21

4.330.00/Na	Balzer plate 3.5; 3 holes; 68 x 12 mm; offset 10; right; stainless steel
4.330.02	Balzer plate 3.5; 2 holes; 68 x 12 mm; offset 21; right; stainless steel
4.330.03	Balzer plate 3.5; 3 holes; 78 x 12 mm; offset 21; right; stainless steel
4.330.04	Balzer plate 3.5; 4 holes; 86 x 12 mm; offset 21; right; stainless steel
4.330.04/Na	Balzer plate 3.5; 4 holes; 76 x 12 mm; offset 10; right; stainless steel

4.333.02	Balzer plate 3.5; 2 holes; 68 x 12 mm; offset 21; left; stainless steel
4.333.03	Balzer plate 3.5; 3 holes; 78 x 12 mm; offset 21; left; stainless steel
4.333.03/Na	Balzer plate 3.5; 3 holes; 68 x 12 mm; offset 10; left; stainless steel
4.333.04	Balzer plate 3.5; 4 holes; 86 x 12 mm; offset 21; left; stainless steel
4.333.04/Na	Balzer plate 3.5; 4 holes; 76 x 12 mm; offset 10; left; stainless steel

offset 17

4.336.03	Balzer plate 3.5; 3 holes; 71 x 12 mm; offset 17; right; stainless steel
4.336.04	Balzer plate 3.5; 4 holes; 80 x 12 mm; offset 17; right; stainless steel
4.337.03	Balzer plate 3.5; 3 holes; 71 x 12 mm; offset 17; left; stainless steel
4.337.04	Balzer plate 3.5; 4 holes; 80 x 12 mm; offset 17; left; stainless steel

ACJ Hook Plate 3.5

Angle-stable; for Screws \varnothing 3.5 mm; Titanium



Item no. 5.3542.1418, right



Item no. 5.3552.1418, left

Item no.	Item description
Angle-stable AC-joint hook plates 3.5; titanium	
5.3542.1418	AC-joint hook plate with conical thread 3,5; offset 14; clasp 18; right; titanium
5.3542.1818	AC-joint hook plate with conical thread 3.5; offset 18; clasp 18; right; titanium
5.3552.1418	AC-joint hook plate with conical thread 3.5; offset 14; clasp 18; left; titanium
5.3552.1818	AC-joint hook plate with conical thread 3.5; offset 18; clasp 18; left; titanium

ACJ Hook Plate 3.5 vas

Variable Angle-stable; for Screws \varnothing 3.5 mm; Titanium



Item no. 5.3563.22/1416, right



Item no. 5.3573.22/1416, left

Item no.	Item description
Variable angle-stable AC-joint hook plates 3.5; titanium	
5.3563.22/1416	AC-joint hook plate with conical thread 3.5; 2/2 holes; offset 14; clasp 16; right; vas; titanium
5.3563.23/1416	AC-joint hook plate with conical thread 3.5; 2/3 holes; offset 14; clasp 16; right; vas; titanium
5.3563.26/1416	AC-joint hook plate with conical thread 3.5; 2/6 holes; offset 14; clasp 16; right; vas; titanium
5.3573.22/1416	AC-joint hook plate with conical thread 3.5; 2/2 holes; offset 14; clasp 16; left; vas; titanium
5.3573.23/1416	AC-joint hook plate with conical thread 3.5; 2/3 holes; offset 14; clasp 16; left; vas; titanium
5.3573.26/1416	AC-joint hook plate with conical thread 3.5; 2/6 holes; offset 14; clasp 16; left; vas; titanium

Set Clavicle Plates 3.5

angle-stable; titanium; set no. 19.478.00



Item no. 5.3502.34, right



Item no. 5.3542.1418, right



Item no. 5.3522.08, right

Set no. 19.478.00  Internal hexagon

Item no.	Item description	Quant.
Implants - plates		
Angle-stable lateral clavicle plate 3.5; titanium		
5.3502.34	3/4 holes; 65 x 10 mm; lateral; right	1
5.3502.36	3/6 holes; 82 x 10 mm; lateral; right	1
5.3512.34	3/4 holes; 65 x 10 mm; lateral; left	1
5.3512.36	3/6 holes; 82 x 10 mm; lateral; left	1

Angle-stable clavicle shaft plates 3.5; titanium		
5.3522.08	8 holes; 99 x 12 mm; right	1
5.3522.10	10 holes; 124 x 12 mm; right	1
5.3532.08	8 holes; 99 x 12 mm; left	1
5.3532.10	10 holes; 124 x 12 mm; left	1

AC-joint hook plates with conical thread 3.5; titanium		
5.3542.1418	offset 14; clasp 18; right	1
5.3542.1818	offset 18; clasp 18; right	1
5.3552.1418	offset 14; clasp 18; left	1
5.3552.1818	offset 18; clasp 18; left	1

Instruments		
10.500.27A	drill guide with handle for small fragment; handle length 55 mm	1
2.904.05	drill bit for quick coupling; Ø 2.5 mm x 105 mm; spiral length 50 mm; double spiral	1
2.9406.25	hex screwdriver with handle for screws Ø 2.7 mm - Ø 4.0 mm; AF 2.5 mm; conical; PPSU	1
2.953.60	gauge with clasp for screws with conical head thread Ø 3.5 mm; Ø 4.0 mm; measuring range 60 mm	1
2.954.01	screw forceps; self holding	1
2.977.01	drill guide for angle stable screwing; length 45 mm; small fragment	2
10.520.30 *	double drill guide Ø 2.5 mm/ Ø 3.5 mm, spring bushing	

* optional

Item no.	Item description	Quant.
Implants - screws		
angle-stable cortical screw Ø 3.5 mm; fully threaded; self tapping; titanium		
 Internal hexagon		
3.133.10	length 10 mm	5
3.133.12	length 12 mm	5
3.133.14	length 14 mm	5
3.133.16	length 16 mm	5
3.133.18	length 18 mm	5
3.133.20	length 20 mm	5
3.133.22	length 22 mm	5
3.133.24	length 24 mm	5

cortical screw Ø 3.5 mm; fully threaded; self tapping; titanium		
 Internal hexagon		
3.132.10	length 10 mm	3
3.132.12	length 12 mm	3
3.132.14	length 14 mm	3
3.132.16	length 16 mm	3
3.132.18	length 18 mm	3
3.132.20	length 20 mm	3

Wire		
6.031.16	Kirschner wire with trocar point and round end; Ø 1.6 mm x 150 mm; stainless steel	5

Container		
19.477.00	perforated autoclavable container with inset for instruments and implants for clavicle plate; small fragment	1

Set Clavicle Plates 3.5

angle-stable; titanium; set no. 19.478.00

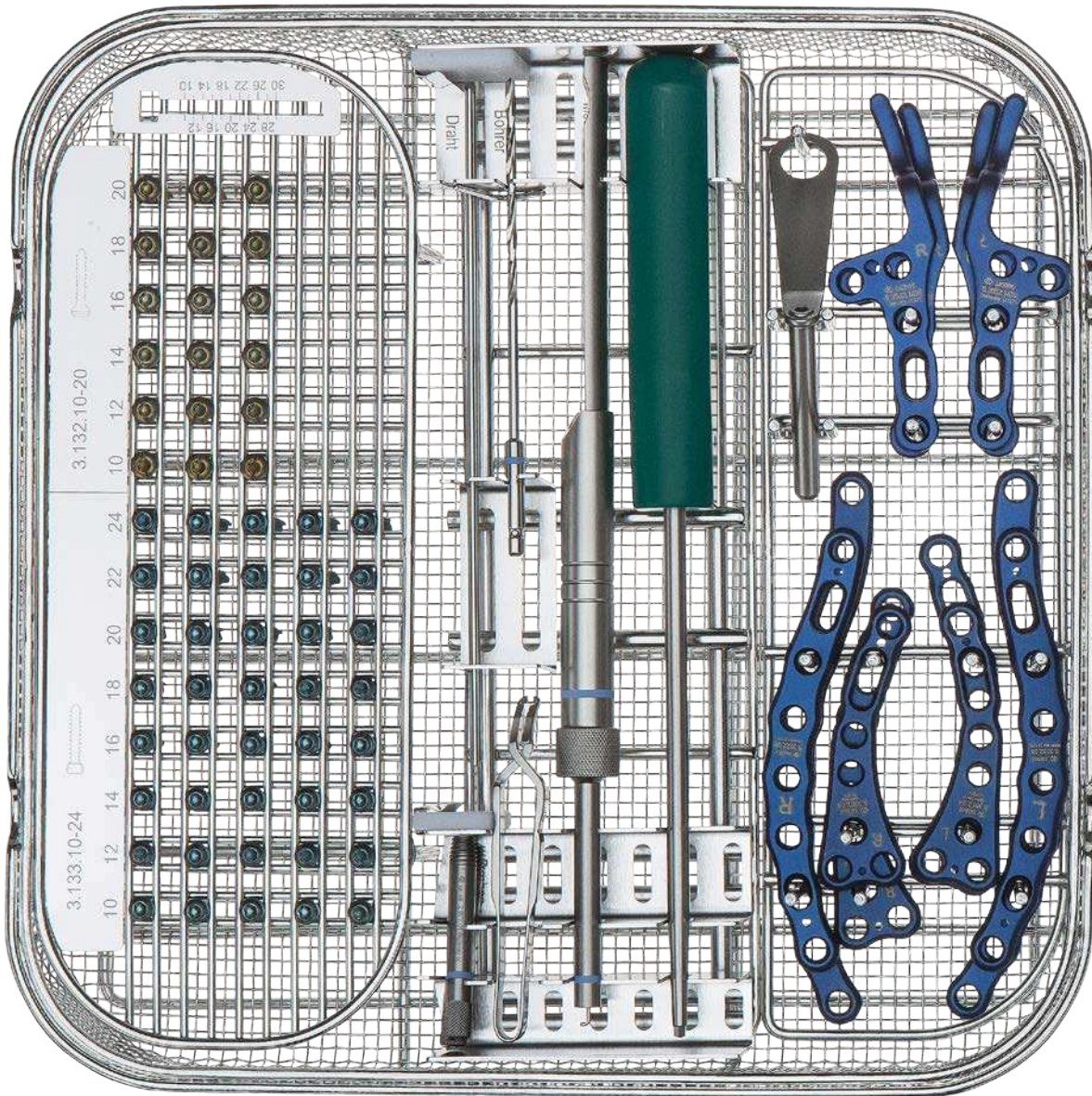

Set no. 19.478.00

 Internal hexagon

Set Clavicula Plates 3.5 vas

variable angle-stable; titanium; set no. 19.479.00



Item no. 5.3513.36, left



Item no. 5.3563.23/1416, right

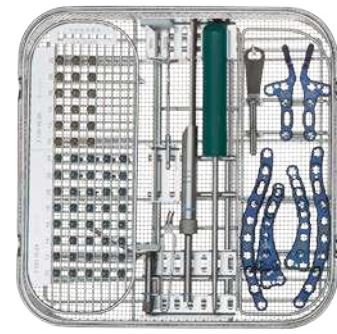

Item no. 5.3523.08, right

Set no. 19.479.00  Internal hexagon

Item no.	Item description	Quant.
Implants - plates		
Variable angle-stable lateral clavicle plate 3.5; titanium		
5.3503.34	3/4 holes; 65 x 10 mm; lateral; right	1
5.3503.36	3/6 holes; 82 x 10 mm; lateral; right	1
5.3513.34	3/4 holes; 65 x 10 mm; lateral; left	1
5.3513.36	3/6 holes; 82 x 10 mm; lateral; left	1

Variable angle-stable clavicle shaft plate 3.5; titanium		
5.3523.08	8 holes; 99 x 12 mm; right	1
5.3523.10	10 holes; 124 x 12 mm; right	1
5.3533.08	8 holes; 99 x 12 mm; left	1
5.3533.10	10 holes; 124 x 12 mm; left	1

Variable angle-stable AC-joint hook plate 3.5; titanium		
5.3563.23/1416	AC-joint hook plate with conic thread 3.5; 2/3 holes; offset 14; clasp 16; right; vas; titanium	1
5.3573.23/1416	AC-joint hook plate with conic thread 3.5; 2/3 holes; offset 14; clasp 16; left; vas; titanium	1

Instruments		
10.500.27A	drill guide with handle for small fragment; handle length 55 mm	1
2.904.05	drill bit for quick coupling; Ø 2.5 mm x 105 mm; spiral length 50 mm; double spiral	1
2.9406.25	hex screwdriver with handle for screws Ø 2.7 mm - Ø 4.0 mm; AF 2.5 mm; conical; PPSU	1
2.953.60	gauge with clasp for screws with conical head thread Ø 3.5 mm; Ø 4.0 mm; measuring range 60 mm	1
2.954.01	screw forceps; self holding	1
2.977.01	drill guide for angle stable screwing; length 45 mm; small fragment	2
2.977.08	drill guide with handle for variable angle-stable screwing; small fragment; length 45 mm	1

Item no.	Item description	Quant.
Implants - screws		
angle-stable cortical screw Ø 3.5 mm; fully threaded; self tapping; titanium		
 Internal hexagon		
3.133.10	length 10 mm	5
3.133.12	length 12 mm	5
3.133.14	length 14 mm	5
3.133.16	length 16 mm	5
3.133.18	length 18 mm	5
3.133.20	length 20 mm	5
3.133.22	length 22 mm	5
3.133.24	length 24 mm	5

Cortical screw Ø 3.5 mm; fully threaded; self tapping; titanium		
 Internal hexagon		
3.132.10	length 10 mm	3
3.132.12	length 12 mm	3
3.132.14	length 14 mm	3
3.132.16	length 16 mm	3
3.132.18	length 18 mm	3
3.132.20	length 20 mm	3

Wire		
6.031.16	Kirschner wire with trocar point and round end; Ø 1.6 mm x 150 mm; stainless steel	5

Container		
19.477.00	perforated autoclavable container with inset for instruments/implants for clavicle plates; small fragment	1

Set Clavicula Plates 3.5 vas

variable angle-stable; titanium; set no. 19.479.00

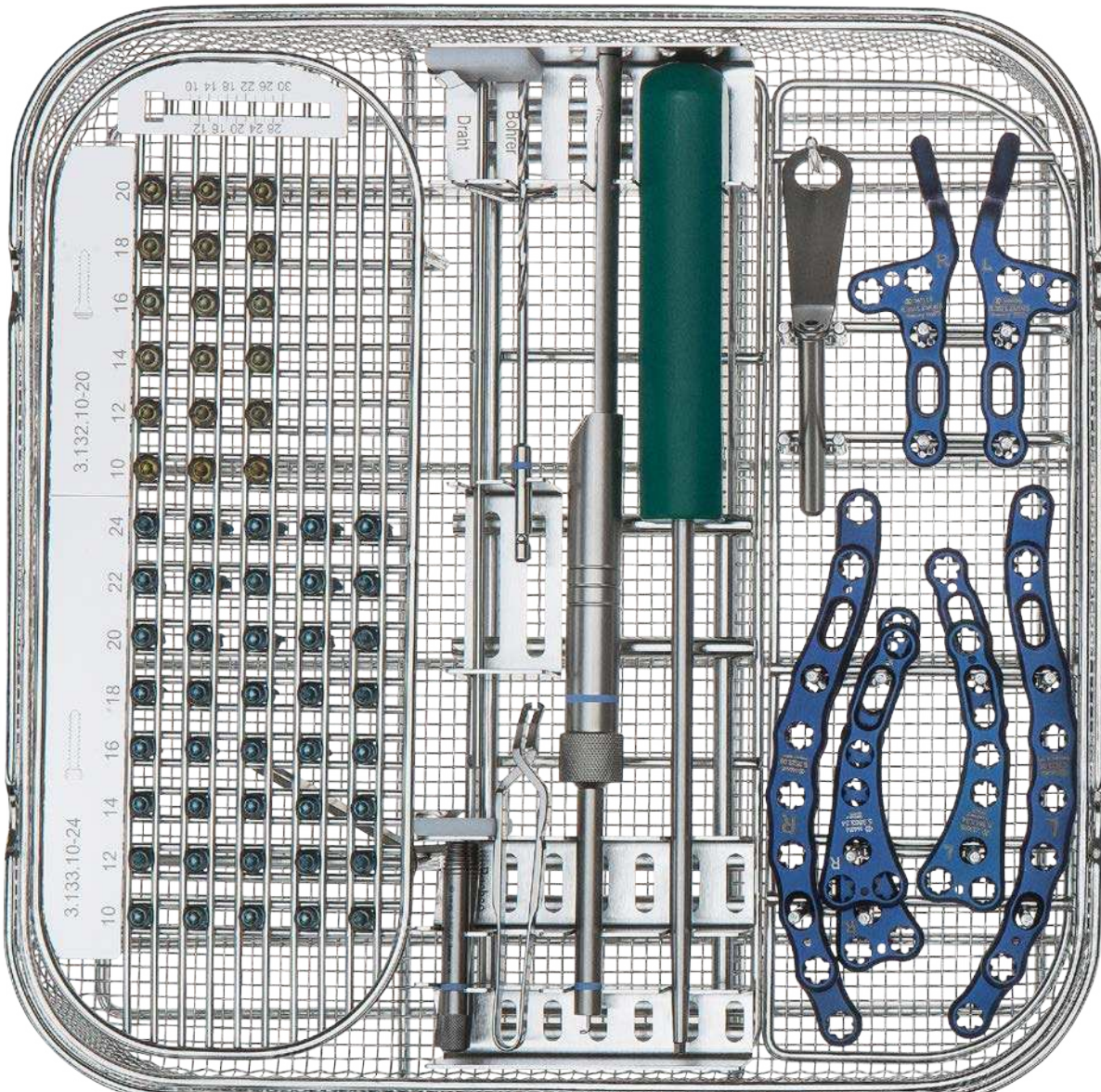

Set no. 19.479.00

 Internal hexagon

Module Humerus and Clavicle plates - SFI

for SFI-Implants



Set - complete: 19.537.00
Set - autoclavable container: 19.536.00

Plates

Implants proximal Humerus with 8 proximal holes

Item designation	Code-No.	Quantity
Prox. Humerus plate w. conic thread 4.0/3.5; 8/3hol; Ln 77; a.s.v.; ti	5.790.83	1
Prox. Humerus plate w. conic thread 4.0/3.5; 8/4hol; Ln 93; a.s.v.; ti	5.790.84	1
Prox. Humerus plate w. conic thread 4.0/3.5; 8/5hol; Ln 109; a.s.v.; ti	5.790.85	1
Prox. Humerus plate w. conic thread 4.0/3.5; 8/6hol; Ln 125; a.s.v.; ti	5.790.86	1



Implants Clavicle

Item designation	Code-No.	Quantity
Clavicle plate w. conic thread 3,5; 3/4hol; 65 x 10; lateral, right; ti	5.3502.34	1
Clavicle plate w. conic thread 3,5; 3/6hol; 82 x 10; lateral, right; ti	5.3502.36	1
Clavicle plate w. conic thread 3,5; 3/4hol; 65 x 10; lateral, left; ti	5.3512.34	1
Clavicle plate w. conic thread 3,5; 3/6hol; 82 x 10; lateral, left; ti	5.3512.36	1



Item designation	Code-No.	Quantity
Clavicle-shank plate w. conic thread 3.5; 8hol; 99 x 12; right; ti	5.3522.08	1
Clavicle-shank plate w. conic thread 3.5; 10hol; 124 x 12; right; ti	5.3522.10	1
Clavicle-shank plate w. conic thread 3.5; 8hol; 99 x 12; left; ti	5.3532.08	1
Clavicle-shank plate w. conic thread 3.5; 10hol; 124 x 12; left; ti	5.3532.10	1



Storage

Item designation	Code-No.	Quantity
Perforated autoclavable container with inset f. implants-modul humerus/clavicle	19.536.00	1



Königsee Implantate GmbH
OT-Aschau - Am Sand 4
D-07426 Allendorf
Fon +49 (0) 36738 498-0
Fax +49 (0) 36738 498-19
e-Mail: info@koenigsee-implantate.de

Module Humerus and Clavicle plates - SFI for SFI-Implants

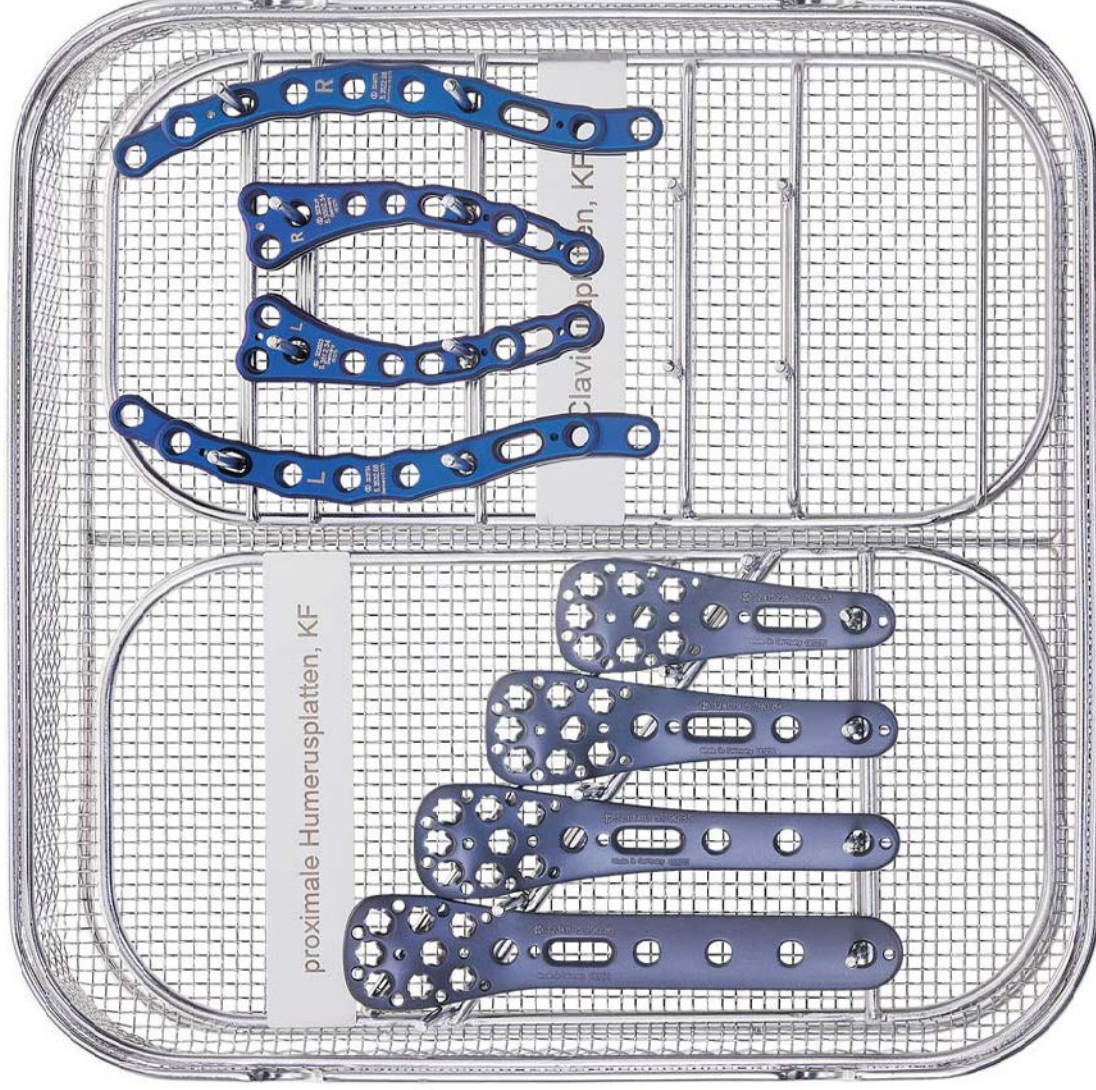

Ligamentfix

plate thickness 1.5 mm; titanium



Item no. 5.990.01







Item no. 5.990.02



Item no. 5.990.05



Item no. 5.990.06

Item no.	Item description	EAN
5.990.01	Ligamentfix; 4 holes; 12 x 4 mm; titanium	 4047075011902
5.990.02	Ligamentfix; 4 holes; 15 x 4.4 mm; titanium	 4047075011919
5.990.05	Ligamentfix; 5 holes; 15 x 4 mm; titanium	 4047075011926
5.990.06	Ligamentfix; 6 holes; 18 x 4 mm; titanium	 4047075011698

HUMERUS

Königsee Implantate

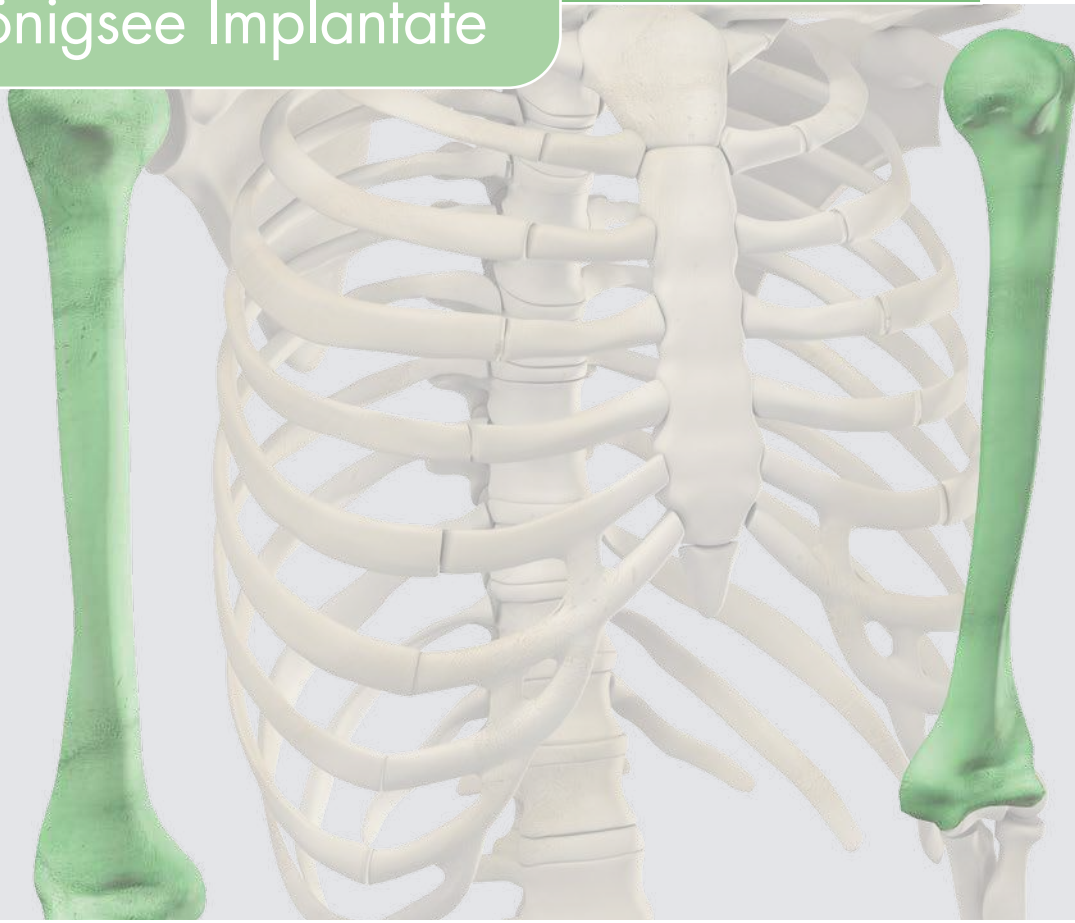

Your Partner in Osteosynthesis

Screw Anchor after Tendon or Ligament Lesions

LASA-/ TESA-/ Transfix screws; with pin; Ø 5.0 bis 6.0 mm; titanium



Item no. 3.734.40



Item no. 3.7302.30



Item no. 3.735.22



Item no. 3.7351.22

Item no.

Item description

LASA-DR screws (Lateral Augmentation Screw Anchor – Double Row)

3.734.30	LASA-DR screw with pin; Ø 6.0 mm; length 30 mm; titanium
3.734.35	LASA-DR screw with pin; Ø 6.0 mm; length 35 mm; titanium
3.734.40	LASA-DR screw with pin; Ø 6.0 mm; length 40 mm; titanium

TESA screw (Tenodesis Screw Anchor)

3.7302.30	TESA screw with pin; Ø 5.0 mm; length 30 mm; titanium
-----------	---

Transfixation screws

3.735.22	transfixation screw for AC Joint with pin; Ø 5.0 mm; length 22 mm; titanium
3.7351.22	transfixation screw for elbow with pin and notch; Ø 5.0 mm; length 22 mm; titanium

Set Screw Anchor

Bone-Tendon Screw Anchor Systems; LASA/TESA/Transfix screws; Titan; Set no. 19.503.00



Item no. 19.503.00

Item no.	Item description	Quant.
Implants – Screws		
LASA-DR screws (Lateral Augmentation Screw Anchor – Double Row); with pin; titanium		
3.734.30	Ø 6.0 mm; length 30 mm	2
3.734.35	Ø 6.0 mm; length 35 mm	2
3.734.40	Ø 6.0 mm; length 40 mm	2

TESA screw (Tenodesis Screw Anchor); with pin; titanium		
3.7302.30	Ø 5.0 mm; length 30 mm	1

Transfixation screws; with pin; titanium		
3.735.22	transfixation screw for AC Joint; Ø 5.0 mm; length 22 mm	1
3.7351.22	transfixation screw for elbow with notch; Ø 5.0 mm; length 22 mm	1

Wire		
6.041.25/180	Kirschner wire with trocar point and round end; Ø 2.5 mm; length 180 mm; stainless steel	5

Item no.	Item description	Quant.
Instruments		
10.177.00	guide frame for screw anchor	1
10.177.01	screw guide sleeve for screw anchor	1
10.177.02	guide sleeve for punch for screw anchor	1
10.1776.04	punch with handle for screw anchor	1
10.1776.05	punch with handle for suture passer	1
10.1776.06	suture passer for screw anchor	1
10.1776.07	hex screwdriver with handle for screw anchor; wrench width 2.5 mm; conical	1
10.1776.10	testing probe with trocar	1
2.954.01	screw forceps; self holding	1

Container		
19.502.00	perforated autoclavable container with inset for instruments/implants shoulder surgery	1

Set Screw Anchor

Bone-Tendon Screw Anchor Systems; LASA/TESA/Transfix screws; Titan; Set no. 19.503.00

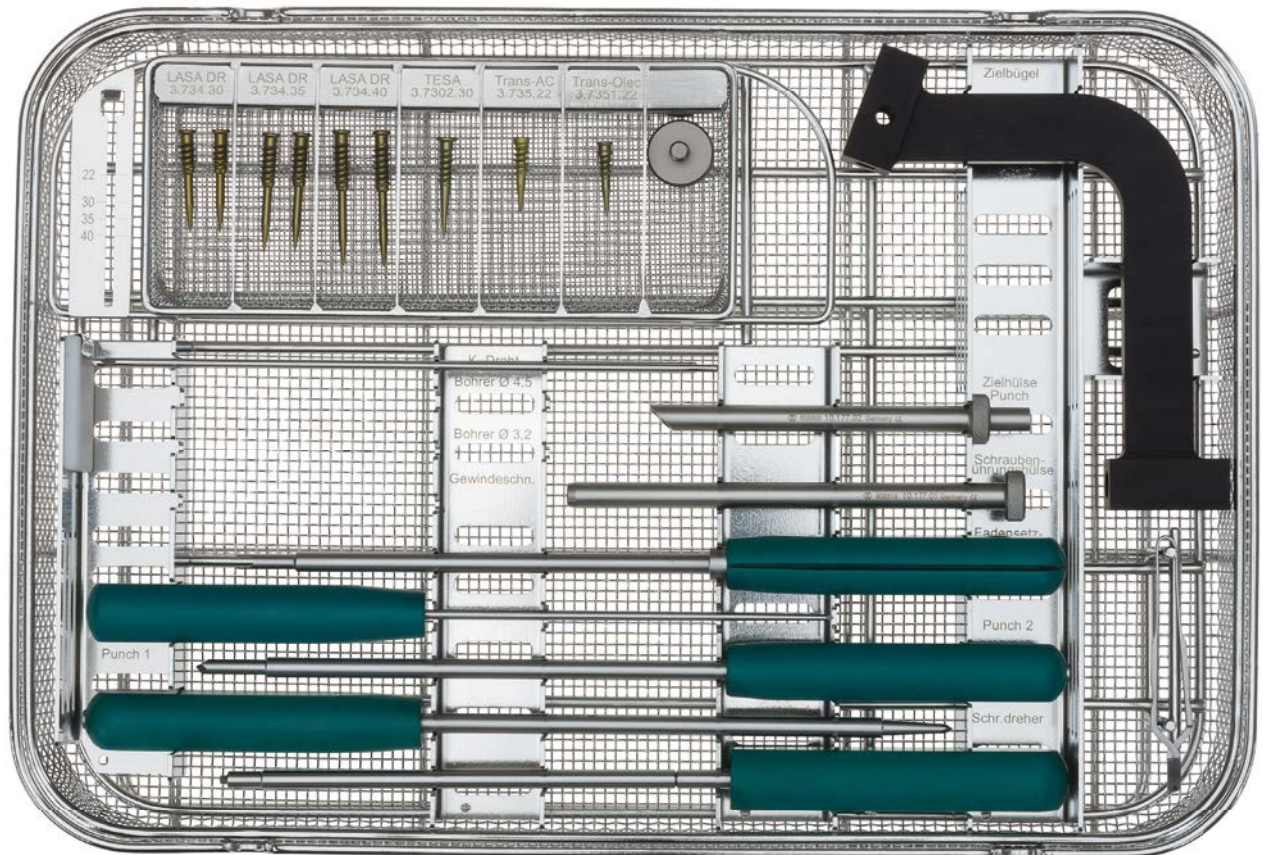

Item no. 19.503.00

Proximal Humerus plate Five 4.0/3.5

angle-stable; for screws \varnothing 4.0/3.5 mm; titanium



Item no. 5.799.07

Item no.	Item description	EAN
Proximal Humerus plate with conical thread 4.0/3.5; titanium		
5.799.01	prox. humerus plate with conical thread 4.0/3.5; 3 holes; 54 x 17 mm; titanium	4 047075 113675
5.799.02	prox. humerus plate with conical thread 4.0/3.5; 2 holes; 49 x 17 mm; titanium	4 047075 114443
5.799.05	prox. humerus plate with conical thread 4.0/3.5; 5 holes; 74 x 17 mm; titanium	4 047075 061303
5.799.06	prox. humerus plate with conical thread 4.0/3.5; 6 holes; 90 x 17 mm; titanium	4 047075 061310
5.799.07	prox. humerus plate with conical thread 4.0/3.5; 7 holes; 106 x 17 mm; titanium	4 047075 061327
5.799.08	prox. humerus plate with conical thread 4.0/3.5; 8 holes; 122 x 17 mm; titanium	4 047075 061334
5.799.09	prox. humerus plate with conical thread 4.0/3.5; 9 holes; 138 x 17 mm; titanium	4 047075 061068
5.799.10	prox. humerus plate with conical thread 4.0/3.5; 10 holes; 154 x 17 mm; titanium	4 047075 061075
5.799.11	prox. humerus plate with conical thread 4.0/3.5; 11 holes; 170 x 17 mm; titanium	4 047075 061082
5.799.12	prox. humerus plate with conical thread 4.0/3.5; 12 holes; 186 x 17 mm; titanium	4 047075 061099
5.799.13	prox. humerus plate with conical thread 4.0/3.5; 13 holes; 202 x 17 mm; titanium	4 047075 061358
5.799.14	prox. humerus plate with conical thread 4.0/3.5; 14 holes; 218 x 17 mm; titanium	4 047075 061365

Set Proximal Humerus plate Five 4.0/3.5

angle-stable; for screws Ø 4.0/3.5 mm; titanium; set no. 19.364.00



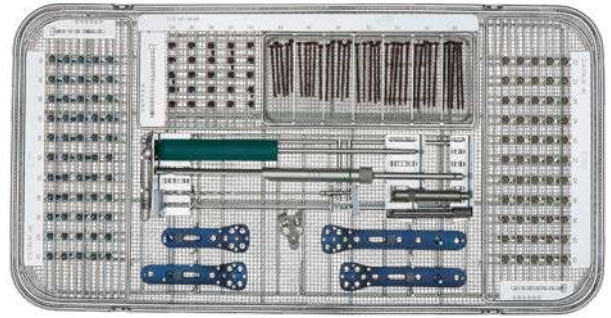

Item no. 5.799.07



Set no. 19.364.00  Internal hexagon

Item no.	Item description	Quant.
Implants – plates		
Proximal Humerus plate with conical thread 4.0/3.5; titanium		
5.799.05	5 holes; 74 x 17 mm	1
5.799.06	6 holes; 90 x 17 mm	1
5.799.07	7 holes; 106 x 17 mm	1
5.799.08	8 holes; 122 x 17 mm	1

Implants – screws		
Cortical screw Ø 3.5 mm; fully threaded; self tapping; titanium 		
3.132.22	length 22 mm	5
3.132.24	length 24 mm	5
3.132.26	length 26 mm	5
3.132.28	length 28 mm	5
3.132.30	length 30 mm	5
3.132.32	length 32 mm	5
3.132.34	length 34 mm	5
3.132.36	length 36 mm	5
3.132.38	length 38 mm	5
3.132.40	length 40 mm	5
3.132.42	length 42 mm	5

Item no.	Item description	Quant.
Implants – screws		
Cortical screw w. conical head thread Ø 3.5 mm; full. thread.; self tapp.; titan. 		
3.133.22	length 22 mm	5
3.133.24	length 24 mm	5
3.133.26	length 26 mm	5
3.133.28	length 28 mm	5
3.133.30	length 30 mm	5
3.133.32	length 32 mm	5
3.133.34	length 34 mm	5
3.133.36	length 36 mm	5
3.133.38	length 38 mm	5
3.133.40	length 40 mm	5
3.133.42	length 42 mm	5
Cancellous screw w. conic. head thread Ø 4.0 mm; full. thread.; self tapp.; titan. 		
3.147.34	length 34 mm	5
3.147.36	length 36 mm	5
3.147.38	length 38 mm	5
3.147.40	length 40 mm	5
3.147.42	length 42 mm	5
3.147.44	length 44 mm	5
3.147.46	length 46 mm	5
3.147.48	length 48 mm	5
3.147.50	length 50 mm	5
3.147.52	length 52 mm	5
3.147.54	length 54 mm	5
3.147.56	length 56 mm	5

Set Proximal Humerus plate Five 4.0/3.5

angle-stable; for screws Ø 4.0/3.5 mm; titanium; set no. 19.364.00

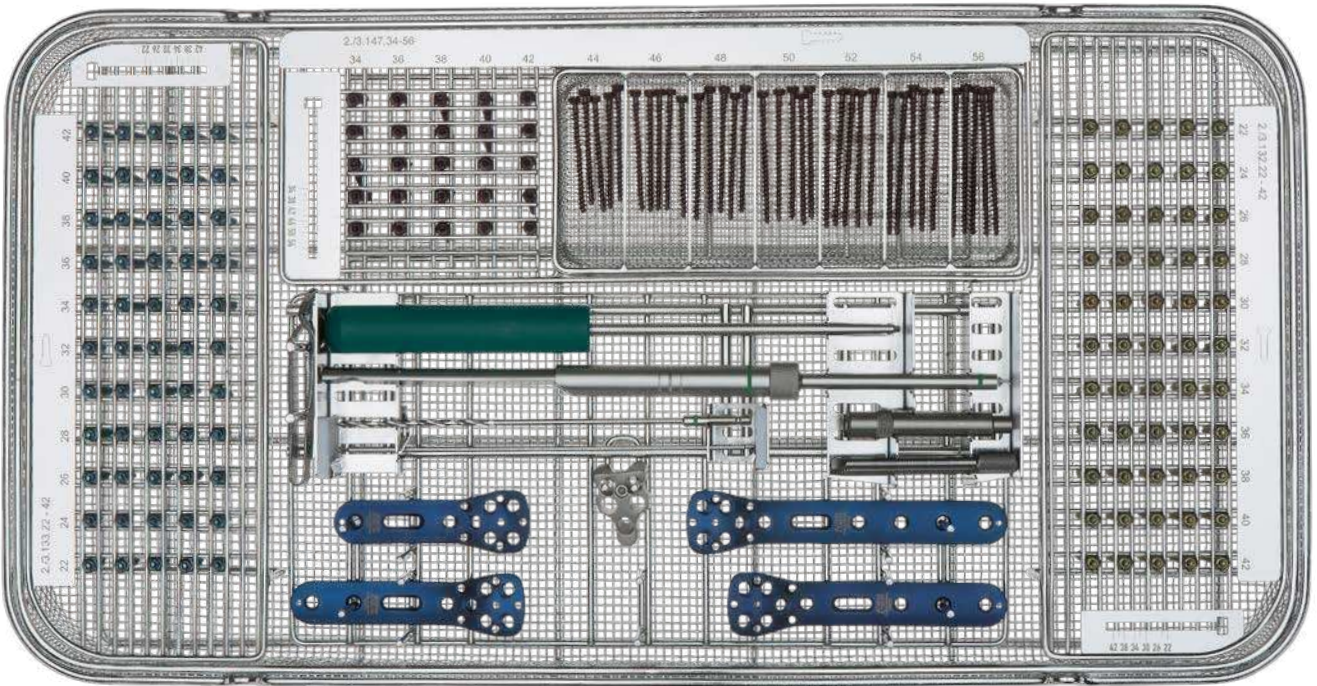

Set no. 19.364.00  Internal hexagon

Item no.	Item description	Quant.
Instruments		
10.173.00	guide block for proximal small fragment humerus plates with 5 headholes	1
10.173.01	sleeve for guide block for proximal small fragment humerus plates	2
10.173.05	screw driver for guide block	1
2.904.22	drill bit for quick coupling, Ø 2.5 x 155 mm, spiral length 60 mm, double spiral	1
2.9406.25	hex screwdriver with handle for screws Ø 2.7 mm - Ø 4.0 mm, AF 2.5 mm, conical	1
2.953.70	gauge with clasp for screws Ø 3.5 mm, Ø 4.0 mm, measuring range 70 mm	1
2.954.01	screw forceps, self holding	1
2.977.04	drill guide for angle stable screwing, length 68 mm, small fragment	2

Item no.	Item description	Quant.
Wire		
6.031.18	Kirschner wire with trocar point and round end, Ø 1.8 x 150 mm, stainless steel	5

Container		
19.363.00	perforated autoclavable container with inset for instruments for humerus-set	1

Proximal Humerus plate Five 4.0/3.5

angle-stable; for screws \varnothing 4.0/3.5 mm; stainless steel



Item no. 5.07913.84

Item no.	Item description	EAN
Proximal Humerus plate with conical thread 4,0/3,5; stainless steel		
4.799.05	proximal humerus plate with conical thread 4.0/3.5, 5 holes, 74 x 17 mm, stainless steel	4 047075 059072
4.799.06	proximal humerus plate with conical thread 4.0/3.5, 6 holes, 90 x 17 mm, stainless steel	4 047075 059089
4.799.07	proximal humerus plate with conical thread 4.0/3.5, 7 holes, 106 x 17 mm, stainless steel	4 047075 059034
4.799.08	proximal humerus plate with conical thread 4.0/3.5, 8 holes, 122 x 17 mm, stainless steel	4 047075 059041
4.799.09	proximal humerus plate with conical thread 4.0/3.5, 9 holes, 138 x 17 mm, stainless steel	4 047075 059003
4.799.10	proximal humerus plate with conical thread 4.0/3.5, 10 holes, 154 x 17 mm, stainless steel	4 047075 059010
4.799.11	proximal humerus plate with conical thread 4.0/3.5, 11 holes, 170 x 17 mm, stainless steel	4 047075 059027
4.799.12	proximal humerus plate with conical thread 4.0/3.5, 12 holes, 186 x 17 mm, stainless steel	4 047075 058006
4.799.13	proximal humerus plate with conical thread 4.0/3.5, 13 holes, 202 x 17 mm, stainless steel	4 047075 058211
4.799.14	proximal humerus plate with conical thread 4.0/3.5, 14 holes, 218 x 17 mm, stainless steel	4 047075 059058

Set Proximal Humerus plate Five 4.0/3.5

angle-stable; for screws Ø 4.0/3.5 mm; stainless steel; set no. 19.365.00





Item no. 4.799.05



Set no. 19.365.00  Internal hexagon

Item no.	Item description	Quant.
Implants – plates		
Proximal Humerus plate with conical thread 4.0/3.5; stainless steel		
4.799.05	5 holes; 74 x 17 mm	1
4.799.06	6 holes; 90 x 17 mm	1
4.799.07	7 holes; 106 x 17 mm	1
4.799.08	8 holes; 122 x 17 mm	1

Implants – screws		
Cortical screw Ø 3.5 mm; fully threaded; self tapping; stainless steel 		
2.132.22	length 22 mm	5
2.132.24	length 24 mm	5
2.132.26	length 26 mm	5
2.132.28	length 28 mm	5
2.132.30	length 30 mm	5
2.132.32	length 32 mm	5
2.132.34	length 34 mm	5
2.132.36	length 36 mm	5
2.132.38	length 38 mm	5
2.132.40	length 40 mm	5
2.132.42	length 42 mm	5

Item no.	Item description	Quant.
Implants – screws		
Cortical screw w. conical head thread Ø 3.5 mm; full. thread.; self tapp.; st.st. 		
2.133.22	length 22 mm	5
2.133.24	length 24 mm	5
2.133.26	length 26 mm	5
2.133.28	length 28 mm	5
2.133.30	length 30 mm	5
2.133.32	length 32 mm	5
2.133.34	length 34 mm	5
2.133.36	length 36 mm	5
2.133.38	length 38 mm	5
2.133.40	length 40 mm	5
2.133.42	length 42 mm	5
Cancellous screw w. conic. head thread Ø 4.0 mm; full. thread.; self tapp.; st.st. 		
2.147.34	length 34 mm	5
2.147.36	length 36 mm	5
2.147.38	length 38 mm	5
2.147.40	length 40 mm	5
2.147.42	length 42 mm	5
2.147.44	length 44 mm	5
2.147.46	length 46 mm	5
2.147.48	length 48 mm	5
2.147.50	length 50 mm	5
2.147.52	length 52 mm	5
2.147.54	length 54 mm	5
2.147.56	length 56 mm	5

Set Proximal Humerus plate Five 4.0/3.5

angle-stable; for screws Ø 4.0/3.5 mm; stainless steel; set no. 19.365.00

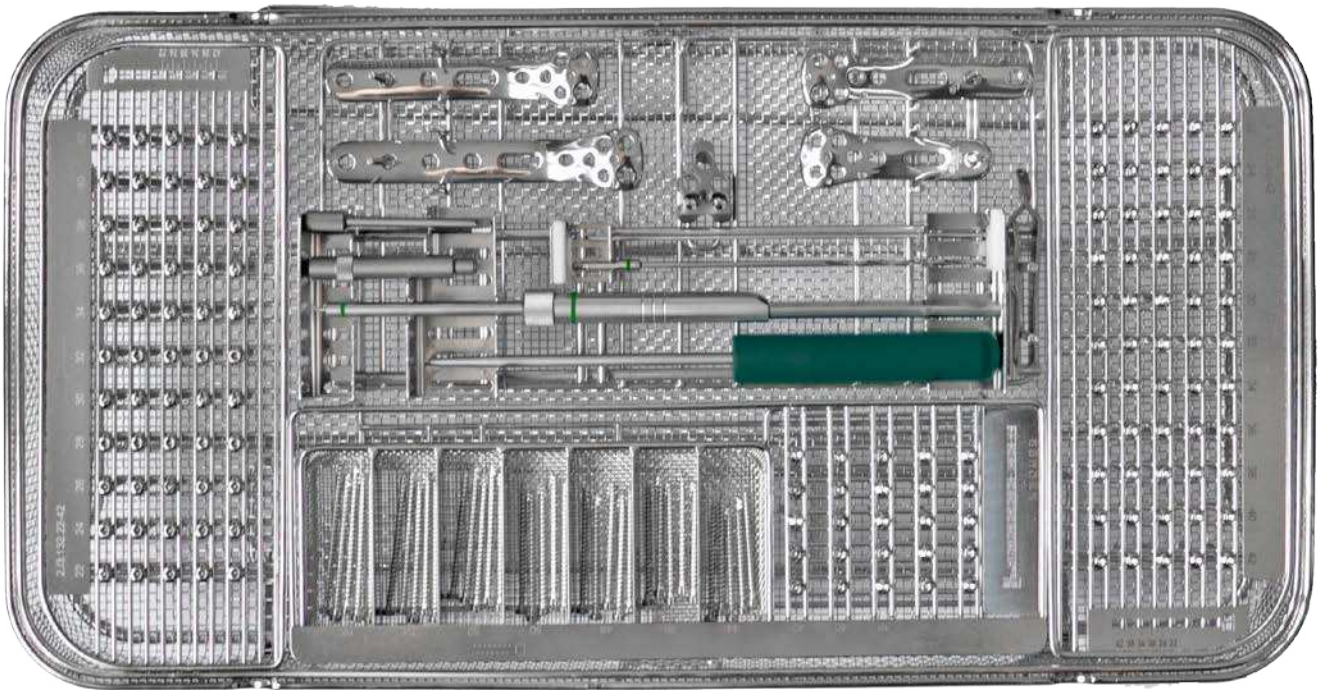

Set no. 19.365.00  Internal hexagon

Item no.	Item description	Quant.
Instruments		
10.173.00	guide block for proximal small fragment humerus plates with 5 headholes	1
10.173.01	sleeve for guide block for proximal small fragment humerus plates	2
10.173.05	screw driver for guide block	1
2.904.22	drill bit for quick coupling, Ø 2.5 x 155 mm, spiral length 60 mm, double spiral	1
2.9406.25	hex screwdriver with handle for screws Ø 2.7 mm - Ø 4.0 mm, AF 2.5 mm, conical	1
2.953.70	gauge with clasp for screws Ø 3.5 mm, Ø 4.0 mm, measuring range 70 mm	1
2.954.01	screw forceps, self holding	1
2.977.04	drill guide for angle stable screwing, length 68 mm, small fragment	2

Item no.	Item description	Quant.
Wire		
6.031.18	Kirschner wire with trocar point and round end, Ø 1.8 x 150 mm, stainless steel	5

Container		
19.363.00	perforated autoclavable container with inset for instruments for humerus-set	1

Proximal Humerus plate Five 4.0/3.5 vas

variable angle-stable; for screws Ø 4.0/3.5 mm; titanium



Item no. 5.797.08

Item no.	Item description	EAN
5.797.05	prox. humerus plate with conic thread 4.0/3.5, 5 holes, 74 x 17 mm, angle stable var., ti	4 047075 112036
5.797.06	prox. humerus plate with conic thread 4.0/3.5, 6 holes, 90 x 17 mm, angle stable var., ti	4 047075 111480
5.797.07	prox. humerus plate with conic thread 4.0/3.5, 7 holes, 106 x 17 mm, angle stable var., ti	4 047075 111497
5.797.08	prox. humerus plate with conic thread 4.0/3.5, 8 holes, 122 x 17 mm, angle stable var., ti	4 047075 116089
5.797.10	prox. humerus plate with conic thread 4.0/3.5, 10 holes, 154 x 17 mm, angle stable var., ti	4 047075 130504
5.797.12	prox. humerus plate with conic thread 4.0/3.5, 12 holes, 186 x 17 mm, angle stable var., ti	4 047075 118199
5.797.14	prox. humerus plate with conic thread 4.0/3.5, 14 holes, 218 x 17 mm, angle stable var., ti	4 047075 130511

Set Proximal Humerus plate Five 4.0/3.5 vas

variable angle-stable; for screws Ø 4.0/3.5 mm; titanium; set no. 19.367.00



Item no. 5.797.05



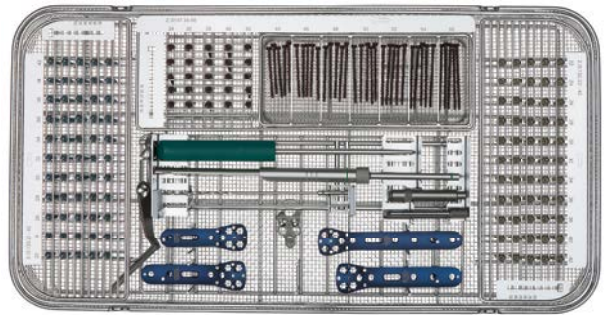

Item no. 5.797.08



Set no. 19.367.00 Internal hexagon

Item no.	Item description	Quant.
Implants – plates		
Proximal Humerus plate with conical thread 4.0/3.5; vas; titanium		
5.797.05	5 holes; 74 x 17 mm	1
5.797.06	6 holes; 90 x 17 mm	1
5.797.07	7 holes; 106 x 17 mm	1
5.797.08	8 holes; 122 x 17 mm	1

Implants – screws		
Cortical screw Ø 3.5 mm; fully threaded; self tapping; titanium		
		
3.132.22	length 22 mm	5
3.132.24	length 24 mm	5
3.132.26	length 26 mm	5
3.132.28	length 28 mm	5
3.132.30	length 30 mm	5
3.132.32	length 32 mm	5
3.132.34	length 34 mm	5
3.132.36	length 36 mm	5
3.132.38	length 38 mm	5
3.132.40	length 40 mm	5
3.132.42	length 42 mm	5

Item no.	Item description	Quant.
Implants – screws		
Cortical screw w. con. head thread; Ø 3.5 mm; fully thread.; self tapp.; titanium		
		
3.133.22	length 22 mm	5
3.133.24	length 24 mm	5
3.133.26	length 26 mm	5
3.133.28	length 28 mm	5
3.133.30	length 30 mm	5
3.133.32	length 32 mm	5
3.133.34	length 34 mm	5
3.133.36	length 36 mm	5
3.133.38	length 38 mm	5
3.133.40	length 40 mm	5
3.133.42	length 42 mm	5
Cancellous screw w. con. head thread; Ø 4.0 mm; fully thread.; self tapp.; titanium		
		
3.147.34	length 34 mm	5
3.147.36	length 36 mm	5
3.147.38	length 38 mm	5
3.147.40	length 40 mm	5
3.147.42	length 42 mm	5
3.147.44	length 44 mm	5
3.147.46	length 46 mm	5
3.147.48	length 48 mm	5
3.147.50	length 50 mm	5
3.147.52	length 52 mm	5
3.147.54	length 54 mm	5
3.147.56	length 56 mm	5

Set Proximal Humerus plate Five 4.0/3.5 vas

variable angle-stable; for screws Ø 4.0/3.5 mm; titanium; set no. 19.367.00

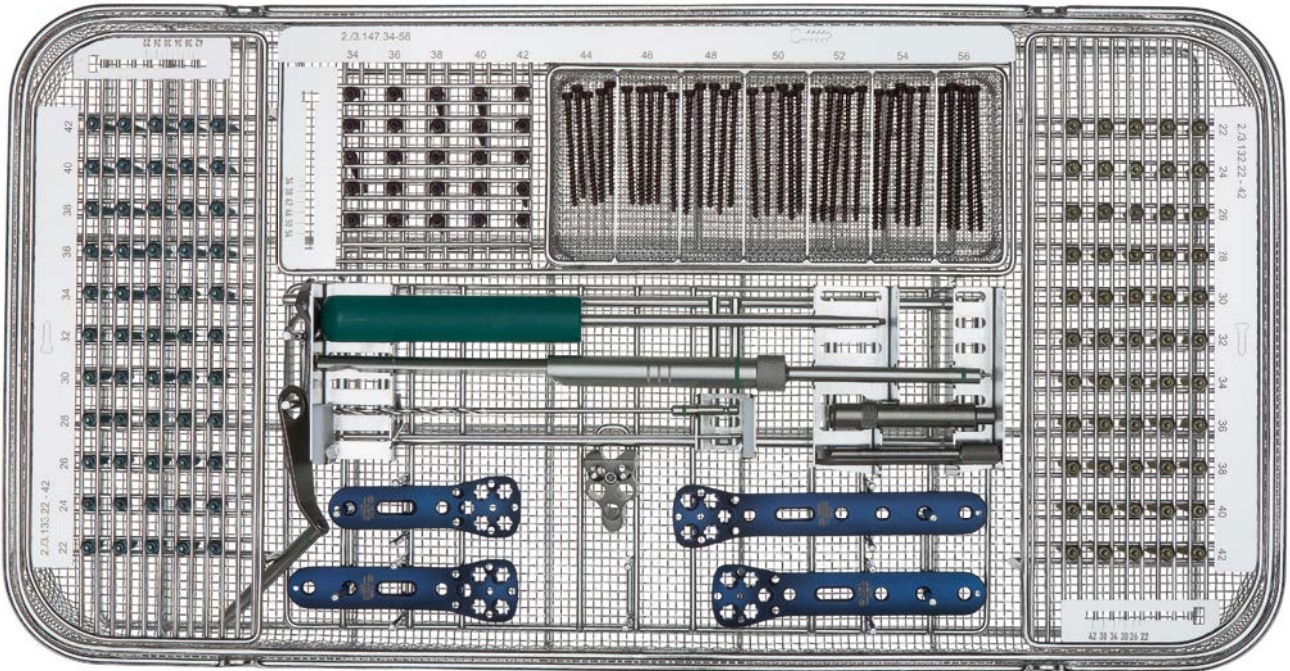

Set no. 19.367.00  Internal hexagon

Item no.	Item description	Quant.
Instruments		
2.904.22	drill bit for quick coupling, Ø 2.5 x 155 mm, spiral length 60 mm, double spiral	1
2.977.04	drill guide for angle stable screwing, length 68 mm, small fragment	2
2.977.09	drill guide wit handle for variable angle stable screwing, small fragment, length 68 mm	1
2.9406.25	hex screwdriver with handle for screws Ø 2.7 mm - Ø 4.0 mm, AF 2.5 mm, conical	1
2.953.70	gauge with clasp for screws Ø 3.5 mm, Ø 4.0 mm, measuring range 70 mm	1
10.173.00	guide block for proximal small fragment humerus plates with 5 headholes	1
10.173.01	sleeve for guide block for proximal small fragment humerus plates	2
10.173.05	screw driver for guide block	1
2.954.01	screw forceps, self holding	1

Item no.	Item description	Quant.
Wire		
6.031.18	Kirschner wire with trocar point and round end, Ø 1.8 x 150 mm, stainless steel	5

Container		
19.366.00	perforated autoclavable container with inset for instruments for humerus-set	1

Proximal Humerus plate Eight 4.0/3.5 vas

variable angle-stable; for screws Ø 4.0/3.5 mm; titanium



Item no. 5.790.85

Item no.	Item description	EAN
proximal Humerus plate 4.0/3.5; vas; titanium		
5.790.82	proximal humerus plate with conic thread 4.0/3.5, 8/2 holes, length 63 mm, angle stable variable, titanium	4 047075 149537
5.790.83	proximal humerus plate with conic thread 4.0/3.5, 8/3 holes, length 77 mm, angle stable variable, titanium	4 047075 149339
5.790.84	proximal humerus plate with conic thread 4.0/3.5, 8/4 holes, length 93 mm, angle stable variable, titanium	4 047075 149346
5.790.85	proximal humerus plate with conic thread 4.0/3.5, 8/5 holes, length 109 mm, angle stable variable, titanium	4 047075 149544
5.790.86	proximal humerus plate with conic thread 4.0/3.5, 8/6 holes, length 125 mm, angle stable variable, titanium	4 047075 149551
5.790.88	proximal humerus plate with conic thread 4.0/3.5, 8/8 holes, length 157 mm, angle stable variable, titanium	4 047075 149568
5.790.810	proximal humerus plate with conic thread 4.0/3.5, 8/10 holes, length 189 mm, angle stable variable, titanium	4 047075 149513
5.790.812	proximal humerus plate with conic thread 4.0/3.5, 8/12 holes, length 221 mm, angle stable variable, titanium	4 047075 149520
5.790.814	proximal humerus plate with conic thread 4.0/3.5, 8/14 holes, length 253 mm, angle stable variable, titanium	4 047075 149889

Set proximal Humerus plate Eight 4.0/3.5 vas

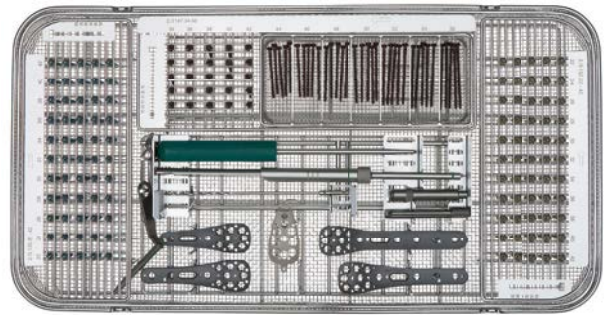

variable angle-stable; for screws Ø 4.0/3.5 mm; titanium; set no. 19.3673.00



Set no. 19.3673.00  Internal hexagon

Item no.	Item description	Quant.
Implants – plates		
proximal Humerus plate with conic thread 4.0/3.5; vas; titanium		
5.790.83	8/3 hole; length 77 mm	1
5.790.84	8/4 hole; length 93 mm	1
5.790.85	8/5 hole; length 109 mm	1
5.790.86	8/6 hole; length 125 mm	1

Implants – screws		
Cortical screw Ø 3.5 mm; fully threaded; self tapping; titanium		
		
3.132.22	length 22 mm	5
3.132.24	length 24 mm	5
3.132.26	length 26 mm	5
3.132.28	length 28 mm	5
3.132.30	length 30 mm	5
3.132.32	length 32 mm	5
3.132.34	length 34 mm	5
3.132.36	length 36 mm	5
3.132.38	length 38 mm	5
3.132.40	length 40 mm	5
3.132.42	length 42 mm	5

Item no.	Item description	Quant.
Implants – screws		
Cortical screw w. con. head thread; Ø 3.5 mm; fully thread.; self tapp.; titanium		
		
3.133.22	length 22 mm	5
3.133.24	length 24 mm	5
3.133.26	length 26 mm	5
3.133.28	length 28 mm	5
3.133.30	length 30 mm	5
3.133.32	length 32 mm	5
3.133.34	length 34 mm	5
3.133.36	length 36 mm	5
3.133.38	length 38 mm	5
3.133.40	length 40 mm	5
3.133.42	length 42 mm	5
Cancellous screw w. con. head thread; Ø 4.0 mm; fully thread.; s.t.; ti		
		
3.147.34	length 34 mm	5
3.147.36	length 36 mm	5
3.147.38	length 38 mm	5
3.147.40	length 40 mm	5
3.147.42	length 42 mm	5
3.147.44	length 44 mm	5
3.147.46	length 46 mm	5
3.147.48	length 48 mm	5
3.147.50	length 50 mm	5
3.147.52	length 52 mm	5
3.147.54	length 54 mm	5
3.147.56	length 56 mm	5

Set proximal Humerus plate Eight 4.0/3.5 vas

variable angle-stable; for screws Ø 4.0/3.5 mm; titanium; set no. 19.3673.00

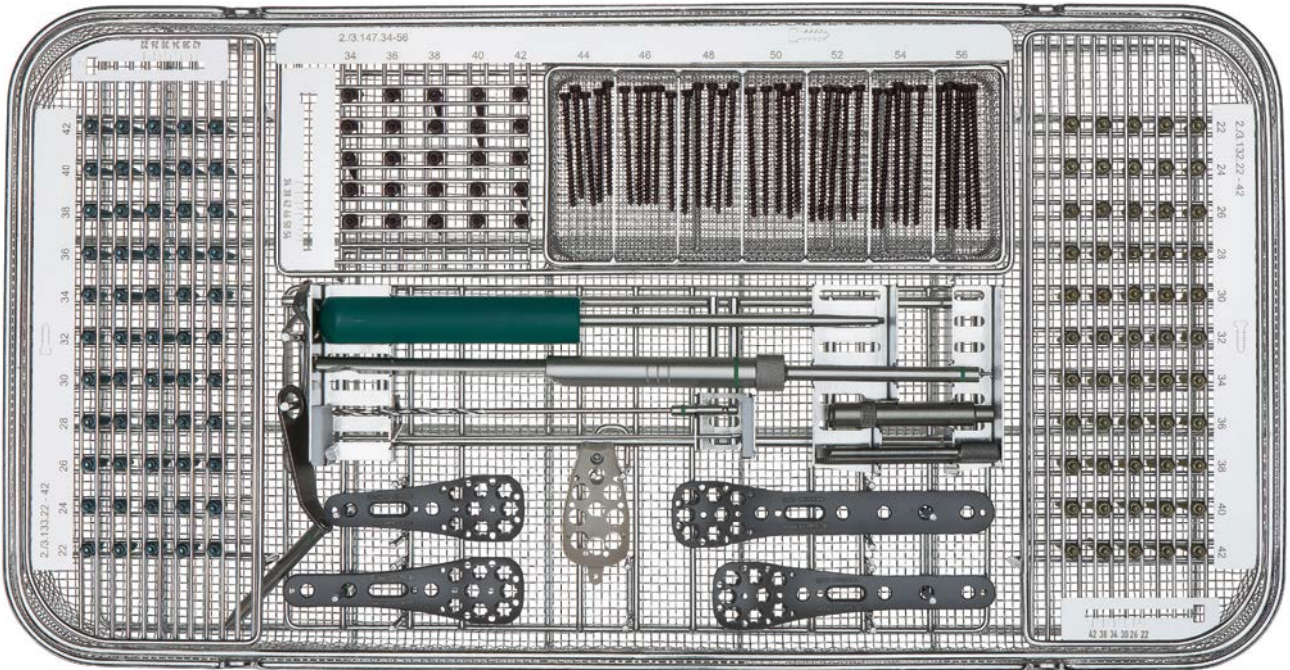

Set no. 19.3673.00  Internal hexagon

Item no.	Item description	Quant.
Instruments		
10.173.01	sleeve for guide block for proximal small fragment humerus plates	2
10.173.05	screw driver for guide block	1
10.179.10	guide block for proximal small fragment humerus plates, 8 holes in head, flat	1
2.904.22	drill bit for quick coupling, Ø 2.5 x 155 mm, spirill length 60 mm, double spiral	1
2.9406.25	hex screwdriver with handle for screws Ø 2.7 mm- Ø 4.0 mm, AF 2.5 mm, conical	1
2.953.70	gauge with clasp for screws Ø 3.5 mm, Ø 4.0 mm, measuring range 70 mm	1
2.954.01	screw forceps, self holding	1
2.977.04	drill guide for angle stable screwing, length 68 mm, small fragment	2
2.977.09	drill guide with handle for variable angle stable screwing, small fragment, length 68 mm	1

Item no.	Item description	Quant.
Wire		
6.031.18	Kirschner wire with trocar point and round end, Ø 1.8 mm x 150 mm, stainless steel	5

Container		
19.366.00	perforated autoclavable container with inset for instruments for humerus-set	1

Set proximal Humerus plate Eight 4.0/3.5 vas

variable angle-stable; for screws Ø 4.0/3.5 mm; titanium; set no. 19.3683.00



Item no. 5.790.83



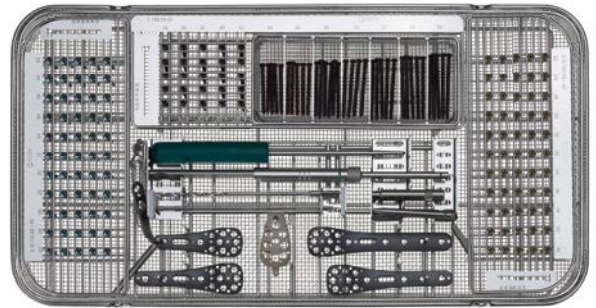

Item no. 5.790.86



Set no. 19.3683.00 Internal hexagon

Item no.	Item description	Quant.
Implants – plates		
Proximal humerus plate with conic thread 4.0/3.5, vas, titanium		
5.790.83	8/3 hole; length 77 mm	1
5.790.84	8/4 hole; length 93 mm	1
5.790.85	8/5 hole; length 109 mm	1
5.790.86	8/6 hole; length 125 mm	1

Implants – screws		
Cortical screw, Ø 3.5 mm, fully threaded, self tapping, titanium 		
3.132.22	length 22 mm	5
3.132.24	length 24 mm	5
3.132.26	length 26 mm	5
3.132.28	length 28 mm	5
3.132.30	length 30 mm	5
3.132.32	length 32 mm	5
3.132.34	length 34 mm	5
3.132.36	length 36 mm	5
3.132.38	length 38 mm	5
3.132.40	length 40 mm	5
3.132.42	length 42 mm	5

Item no.	Item description	Quant.
Implants – screws		
Cortical screw w. con. head thread, Ø 3.5 mm, fully thread., self tapp., tit. 		
3.133.22	length 22 mm	5
3.133.24	length 24 mm	5
3.133.26	length 26 mm	5
3.133.28	length 28 mm	5
3.133.30	length 30 mm	5
3.133.32	length 32 mm	5
3.133.34	length 34 mm	5
3.133.36	length 36 mm	5
3.133.38	length 38 mm	5
3.133.40	length 40 mm	5
3.133.42	length 42 mm	5
Cortical screw w. con. head thread Ø 4.0 mm, self tapping, titanium 		
3.148.34	length 34 mm	5
3.148.36	length 36 mm	5
3.148.38	length 38 mm	5
3.148.40	length 40 mm	5
3.148.42	length 42 mm	5
3.148.44	length 44 mm	5
3.148.46	length 46 mm	5
3.148.48	length 48 mm	5
3.148.50	length 50 mm	5
3.148.52	length 52 mm	5
3.148.54	length 54 mm	5
3.148.56	length 56 mm	5

Set proximal Humerus plate Eight 4.0/3.5 vas

variable angle-stable; for screws Ø 4.0/3.5 mm; titanium; set no. 19.3683.00

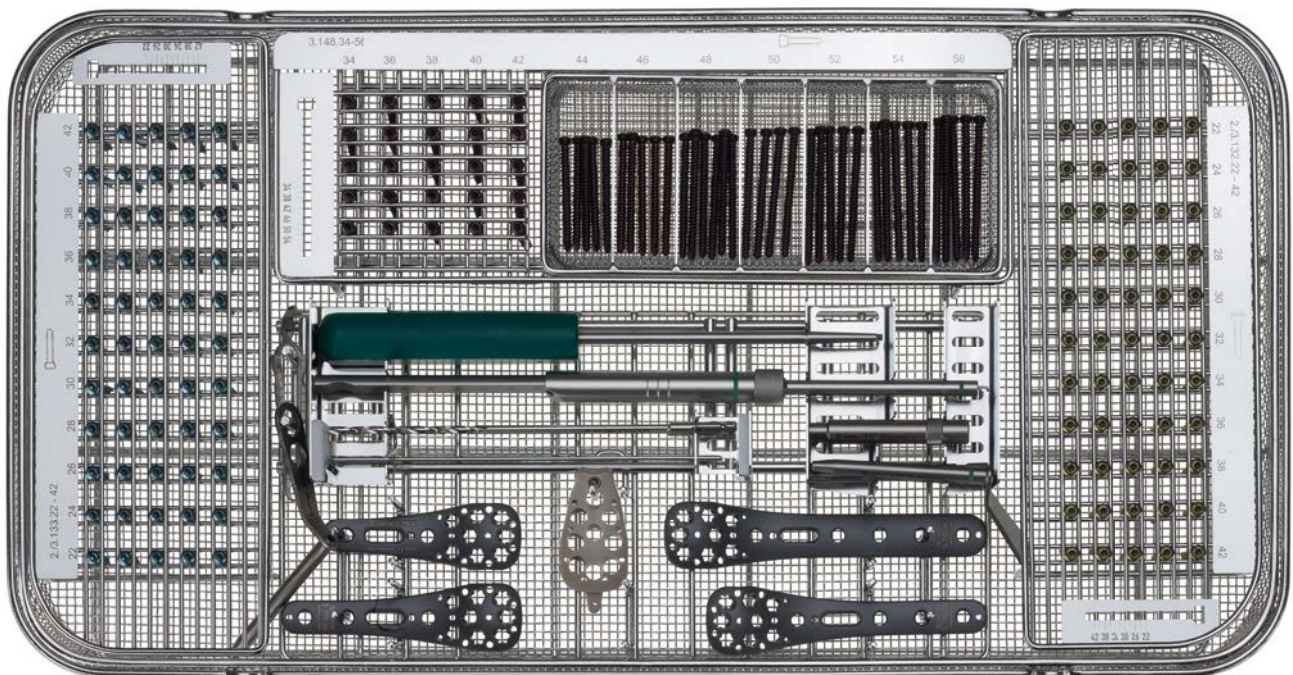

Set no. 19.3683.00  Internal hexagon

Item no.	Item description	Quant.
Instruments		
10.173.01	sleeve for guide block for proximal small fragment humerus plates	2
10.173.05	screw driver for guide block	1
10.179.10	guide block for proximal small fragment humerus plates, 8 holes in head, flat	1
2.904.22	drill bit for quick coupling, Ø 3.0 x 155 mm, spiral length 60 mm, double spiral	1
2.904.25	hex screwdriver with handle for screws Ø 2.7 mm - Ø 4.0 mm, AF 2.5 mm, conical	1
2.9406.25	gauge with clasp for screws Ø 3.5 mm, Ø 4.0 mm, measuring range 70 mm	1
2.953.70	screw forceps, self holding	1
2.954.01	drill guide for angle stable screwing, length 68 mm, small fragment	1
2.977.04	drill guide with handle for variable angle stable screwing, small fragment, length 68 mm	1
2.977.09	drill guide for angle stable screwing 4.0, length 68 mm	1
2.977.16	drill guide with handle for variable angle stable screwing 4.0, length 68 mm	1
2.977.17	drill guide with handle for variable angle stable screwing 4.0, length 68 mm	1

Item no.	Item description	Quant.
Wire		
6.031.18	Kirschner wire with trocar point and round end, Ø 1.8 x 150 mm, stainless steel	5

Container		
19.3661.00	perforated autoclavable container with inset for instruments/implants for humerus, variable angle-stable, with screws 3.148.XX	1

EN VaWiKo[®] proximal Humerus plate 4.0/3.5

variable angle-stable; for screws Ø 4.0/3.5 mm; titanium



Item no. 5.07913.84

Item no.	Item description	EAN
----------	------------------	-----

VaWiKo[®] proximal Humerus plate 4.0/3.5; titanium

5.07913.83	VaWiKo [®] proximal Humerus plate 4.0/3.5; 8/3 hole; length 77 mm
5.07913.84	VaWiKo [®] proximal Humerus plate 4.0/3.5; 8/4 hole; length 93 mm
5.07913.85	VaWiKo [®] proximal Humerus plate 4.0/3.5; 8/5 hole; length 109 mm
5.07913.86	VaWiKo [®] proximal Humerus plate 4.0/3.5; 8/6 hole; length 125 mm
5.07913.87	VaWiKo [®] proximal Humerus plate 4.0/3.5; 8/6 hole; length 141 mm
5.07913.88	VaWiKo [®] proximal Humerus plate 4.0/3.5; 8/8 hole; length 157 mm



Information

The system name VaWiKo[®] is derived from the German designation „Variabel winkelstabile Kombination“, which translates into English as „variable angle-stable combination“. This system combines conventional plating technologies with angle-stable locking in variable angles.

VaWiKo[®] is a registered trademark of Königsee Implantate GmbH.



Königsee Implantate GmbH
OT Aschau | Am Sand 4
07426 Allendorf | Germany

Fon +49 36738 498-560
Fax +49 36738 498-569

Mail export@koenigsee-implantate.de

For further information please visit:
www.koenigsee-implantate.com

HeBo | Edition 02 | 2019-10
All pictured products are CE compliant.

Set VaWiKo® proximal Humerus plate 4.0/3.5

variable angle-stable; for screws Ø 4.0/3.5 mm; titanium; set no. 19.3751.00



Item no. 5.07913.83



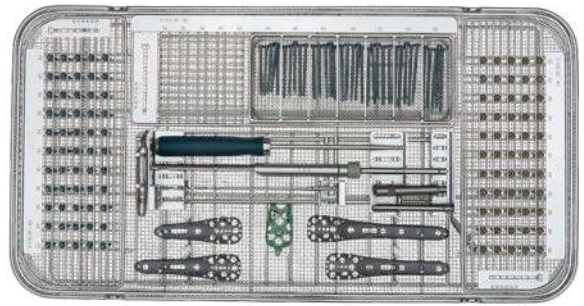

Item no. 5.07913.86



Set no. 19.3751.00  Internal hexagon

Item no.	Item description	Quant.
Implants – plates		
VaWiKo® proximal Humerus plate 4.0/3.5; vas; titanium		
5.07913.83	8/3 holes; length 77 mm	1
5.07913.84	8/4 holes; length 93 mm	1
5.07913.85	8/5 holes; length 109 mm	1
5.07913.86	8/6 holes; length 125 mm	1

Implants – screws		
Cortical screw Ø 3.5 mm; fully threaded; self tapping; titanium 		
3.132.22	length 22 mm	5
3.132.24	length 24 mm	5
3.132.26	length 26 mm	5
3.132.28	length 28 mm	5
3.132.30	length 30 mm	5
3.132.32	length 32 mm	5
3.132.34	length 34 mm	5
3.132.36	length 36 mm	5
3.132.38	length 38 mm	5
3.132.40	length 40 mm	5
3.132.42	length 42 mm	5

Item no.	Item description	Quant.
Implants – screws		
Cortical screw with conical head thread; Ø 3.5 mm; fully threaded; self tapping; titanium 		
3.133.22	length 22 mm	5
3.133.24	length 24 mm	5
3.133.26	length 26 mm	5
3.133.28	length 28 mm	5
3.133.30	length 30 mm	5
3.133.32	length 32 mm	5
3.133.34	length 34 mm	5
3.133.36	length 36 mm	5
3.133.38	length 38 mm	5
3.133.40	length 40 mm	5
3.133.42	length 42 mm	5
3.133.44	length 44 mm	5
3.133.46	length 46 mm	5
3.133.48	length 48 mm	5
3.133.50	length 50 mm	5
3.133.52	length 52 mm	5
3.133.54	length 54 mm	5
3.133.56	length 56 mm	5

Information

The system name VaWiKo® is derived from the German designation „Variabel winkelstabile Kombination“, which translates into English as „variable angle-stable combination“. This system combines conventional plating technologies with angle-stable locking in variable angles.

VaWiKo® is a registered trademark of Königsee Implantate GmbH.



Königsee Implantate GmbH
OT Aschau | Am Sand 4
07426 Allendorf | Germany

Fon +49 36738 498-560
Fax +49 36738 498-569

Mail export@koenigsee-implantate.de

For further information please visit:
www.koenigsee-implantate.com

HeBo | Edition 02 | 2019-10
All pictured products are CE compliant.

Set VaWiKo® proximal Humerus plate 4.0/3.5

variable angle-stable; for screws Ø 4.0/3.5 mm; titanium; set no. 19.3751.00

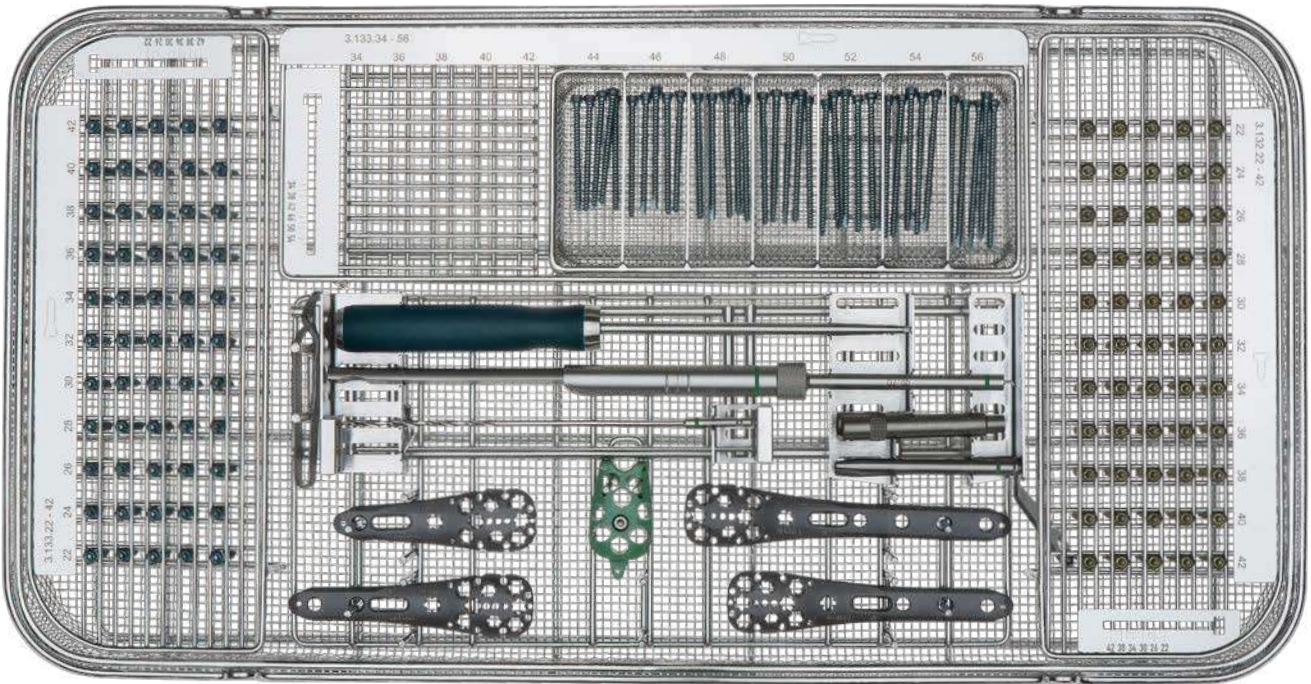

Set no.19.3751.00  Internal hexagon

Item no.	Item description	Quant.
Instruments		
10.173.01	sleeve for guide block for proximal small fragment humerus plates	2
10.179.15	aiming block for proximal humerus plates 5.07913.8X	1
2.904.22	drill bit for quick coupling, Ø 2.5 x 155 mm, spiral length 60 mm, double spiral	1
2.9405.25	hex screwdriver for Ø 2.7 - Ø 4.0 mm; wrench size 2.5 mm; conical; length 215 mm	1
2.953.70	gauge with clasp for screws Ø 3.5 mm, Ø 4.0 mm, measuring range 70 mm	1
2.954.01	screw forceps, self holding	1
2.977.04	drill guide for angle stable screwing, length 68 mm, small fragment	2
2.977.09	drill guide with handle for variable angle stable screwing, small fragment, length 68 mm	1

Item no.	Item description	Quant.
Wire		
6.031.16	Kirschner wire with trocar point and round end, Ø 1.6 mm x 150 mm, stainless steel	5
Container		
19.3741.00	perforated autoclavable container with inset for VaWiKo® proximal humerus plates 5.07913.8X; Ø 3.5 mm	1

Set VaWiKo® proximal Humerus plate 4.0/3.5

variable angle-stable; for screws Ø 4.0/3.5 mm; titanium; set no. 19.3752.00



Item no. 5.07913.83



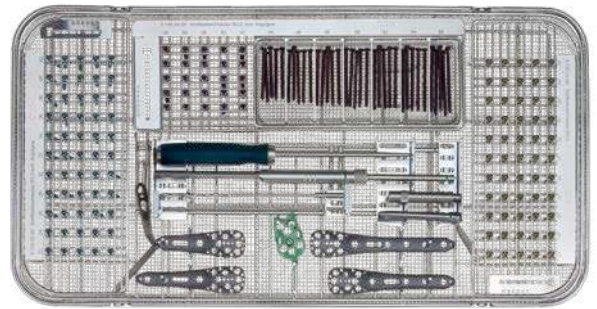

Item no. 5.07913.86



Set no. 19.3752.00 Internal hexagon

Item no.	Item description	Quant.
Implants – plates		
VaWiKo® proximal Humerus plate 4.0/3.5; vas; titanium		
5.07913.83	8/3 holes; length 77 mm	1
5.07913.84	8/4 holes; length 93 mm	1
5.07913.85	8/5 holes; length 109 mm	1
5.07913.86	8/6 holes; length 125 mm	1

Implants – screws		
Cortical screw Ø 3.5 mm; fully threaded; self tapping; titanium 		
3.132.22	length 22 mm	5
3.132.24	length 24 mm	5
3.132.26	length 26 mm	5
3.132.28	length 28 mm	5
3.132.30	length 30 mm	5
3.132.32	length 32 mm	5
3.132.34	length 34 mm	5
3.132.36	length 36 mm	5
3.132.38	length 38 mm	5
3.132.40	length 40 mm	5
3.132.42	length 42 mm	5

Item no.	Item description	Quant.
Implants – screws		
Cortical screw w. con. head thread; Ø 3.5 mm; fully thread.; self tapp.; titanium 		
3.133.22	length 22 mm	5
3.133.24	length 24 mm	5
3.133.26	length 26 mm	5
3.133.28	length 28 mm	5
3.133.30	length 30 mm	5
3.133.32	length 32 mm	5
3.133.34	length 34 mm	5
3.133.36	length 36 mm	5
3.133.38	length 38 mm	5
3.133.40	length 40 mm	5
3.133.42	length 42 mm	5
Cortical screw w. con. head thread; Ø 4.0 mm; self tapp.; titanium 		
3.148.34	length 34 mm	5
3.148.36	length 36 mm	5
3.148.38	length 38 mm	5
3.148.40	length 40 mm	5
3.148.42	length 42 mm	5
3.148.44	length 44 mm	5
3.148.46	length 46 mm	5
3.148.48	length 48 mm	5
3.148.50	length 50 mm	5
3.148.52	length 52 mm	5
3.148.54	length 54 mm	5
3.148.56	length 56 mm	5

Set VaWiKo® proximal Humerus plate 4.0/3.5

variable angle-stable; for screws Ø 4.0/3.5 mm; titanium; set no. 19.3752.00

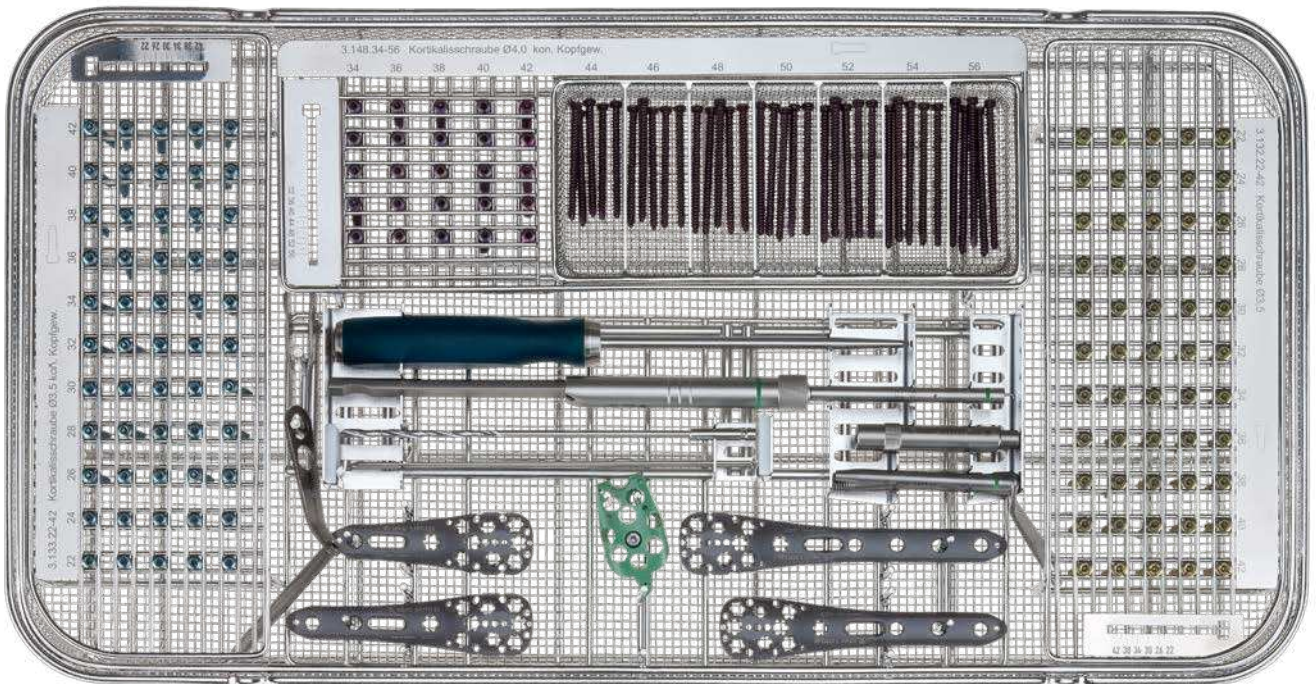

Set no. 19.3752.00  Internal hexagon

Item no.	Item description	Quant.
Instruments		
10.173.01	sleeve for guide block for proximal small fragment humerus plates	2
10.179.15	aiming block f. prox. humerus pl. 5.07913.8X	1
2.904.22	drill bit for quick coupling, Ø 2.5 x 155 mm, spiral length 60 mm, double spiral	1
2.904.25	drill bit for quick coupling, Ø 3.0 x 155 mm, spiral length 60 mm, double spiral	1
2.9405.25	hex screwdriver for Ø 2.7 mm - Ø 4.0 mm; wrench size 2.5 mm; conical; length 215 mm	1
2.953.70	gauge with clasp for screws Ø 3.5 mm, Ø 4.0 mm, measuring range 70 mm	1
2.954.01	screw forceps, self holding	1
2.977.04	drill guide for angle stable screwing, length 68 mm, small fragment	1
2.977.09	drill guide w.handle for variable angle stable screwing, small fragment, length 68 mm	1
2.977.16	drill guide for angle stable screwing 4.0, length 68 mm	1
2.977.17	drill guide with handle for variable angle stable screwing 4.0, length 68 mm	1

Item no.	Item description	Quant.
Wire		
6.031.16	Kirschner wire with trocar point and round end, Ø 1.6 mm x 150 mm, stainless steel	5

Item no.	Item description	Quant.
Container		
19.3742.00	perforated autoclavable container with inset for VaWiKo® proximal humerus plates 5.07913.8X; Ø 4.0 mm; Ø 3.5 mm	1

Information

The system name VaWiKo® is derived from the German designation „Variabel winkelstabile Kombination“, which translates into English as „variable angle-stable combination“. This system combines conventional plating technologies with angle-stable locking in variable angles.

VaWiKo® is a registered trademark of Königsee Implantate GmbH.



Königsee Implantate GmbH
OT Aschau | Am Sand 4
07426 Allendorf | Germany

Fon +49 36738 498-560
Fax +49 36738 498-569

Mail export@koenigsee-implantate.de

For further information please visit:
www.koenigsee-implantate.com

HeBo | Edition 02 | 2019-10
All pictured products are CE compliant.

Set VaWiKo[®] proximal Humerus plate 4.0/3.5

variable angle-stable; for screws Ø 4.0/3.5 mm; titanium; set no. 19.3753.00



Item no. 5.07913.83



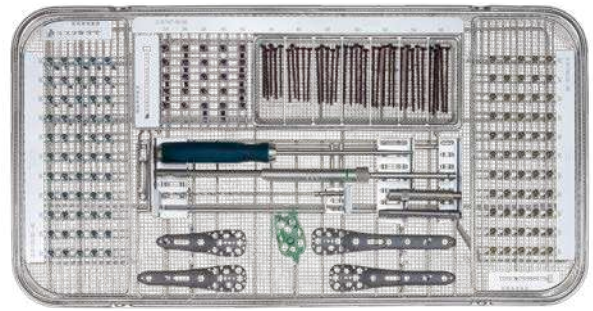

Item no. 5.07913.86



Set no. 19.3753.00 Internal hexagon

Item no.	Item description	Quant.
Implants – plates		
VaWiKo [®] proximal Humerus plate 4.0/3.5; vas; titanium		
5.07913.83	8/3 holes; length 77 mm	1
5.07913.84	8/4 holes; length 93 mm	1
5.07913.85	8/5 holes; length 109 mm	1
5.07913.86	8/6 holes; length 125 mm	1

Implants – screws		
Cortical screw Ø 3.5 mm; fully threaded; self tapping; titanium 		
3.132.22	length 22 mm	5
3.132.24	length 24 mm	5
3.132.26	length 26 mm	5
3.132.28	length 28 mm	5
3.132.30	length 30 mm	5
3.132.32	length 32 mm	5
3.132.34	length 34 mm	5
3.132.36	length 36 mm	5
3.132.38	length 38 mm	5
3.132.40	length 40 mm	5
3.132.42	length 42 mm	5

Item no.	Item description	Quant.
Implants – screws		
Cortical screw w. con. head thread; Ø 3.5 mm; fully thread.; self tapp.; titanium 		
3.133.22	length 22 mm	5
3.133.24	length 24 mm	5
3.133.26	length 26 mm	5
3.133.28	length 28 mm	5
3.133.30	length 30 mm	5
3.133.32	length 32 mm	5
3.133.34	length 34 mm	5
3.133.36	length 36 mm	5
3.133.38	length 38 mm	5
3.133.40	length 40 mm	5
3.133.42	length 42 mm	5
Cancellous screw w. con. head thread; Ø 4.0 mm; fully thread.; s.t.; ti 		
3.147.34	length 34 mm	5
3.147.36	length 36 mm	5
3.147.38	length 38 mm	5
3.147.40	length 40 mm	5
3.147.42	length 42 mm	5
3.147.44	length 44 mm	5
3.147.46	length 46 mm	5
3.147.48	length 48 mm	5
3.147.50	length 50 mm	5
3.147.52	length 52 mm	5
3.147.54	length 54 mm	5
3.147.56	length 56 mm	5

Set VaWiKo[®] proximal Humerus plate 4.0/3.5

variable angle-stable; for screws Ø 4.0/3.5 mm; titanium; set no. 19.3753.00

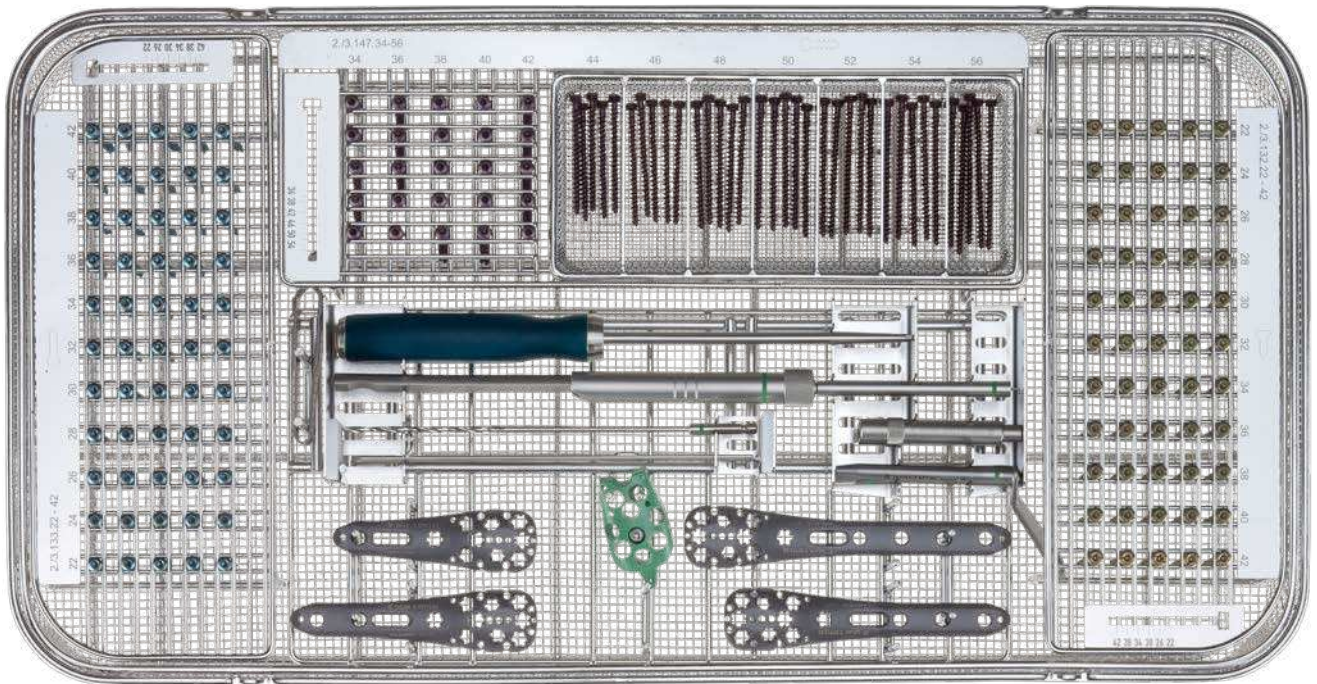

Set no. 19.3753.00  Internal hexagon

Item no.	Item description	Quant.
Instruments		
10.173.01	sleeve for guide block for proximal small fragment humerus plates	2
10.179.15	aiming block for proximal humerus plates 5.07913.8X	1
2.904.22	drill bit for quick coupling, Ø2.5 x 155 mm, spiral length 60 mm, double spiral	1
2.9405.25	hex screwdriver for Ø2.7 - Ø 4.0mm; wrench size 2.5 mm; conical; length 215 mm	1
2.953.70	gauge with clasp for screws Ø 3.5 mm, Ø 4.0 mm, measuring range 70 mm	1
2.954.01	screw forceps, self holding	1
2.977.04	drill guide for angle stable screwing, length 68 mm, small fragment	2
2.977.09	drill guide with handle for variable angle stable screwing, small fragment, length 68 mm	1

Item no.	Item description	Quant.
Wire		
6.031.16	Kirschner wire with trocar point and round end, Ø 1.6 mm x 150 mm, stainless steel	5

Container		
19.3743.00	perforated autocl. container with inset for VaWiKo proximal humerus plates 5.07913.8X; Ø 3.5 mm; Ø 4.0 mm	1

Information

The system name VaWiKo[®] is derived from the German designation „Variabel winkelstabile Kombination“, which translates into English as „variable angle-stable combination“. This system combines conventional plating technologies with angle-stable locking in variable angles.

VaWiKo[®] is a registered trademark of Königsee Implantate GmbH.



Königsee Implantate GmbH
OT Aschau | Am Sand 4
07426 Allendorf | Germany

Fon +49 36738 498-560
Fax +49 36738 498-569

Mail export@koenigsee-implantate.de

For further information please visit:
www.koenigsee-implantate.com

HeBo | Edition 02 | 2019-10
All pictured products are CE compliant.

Set Aiming device for VaWiKo® prox. Humerus plate 4.0/3.5

Set no. 19.375.00



Item no. 10.270.01

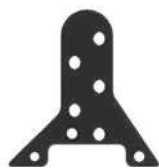

Item no. 10.270.02



Item no. 10.270.03



Item no. 10.270.05 / 10.270.06

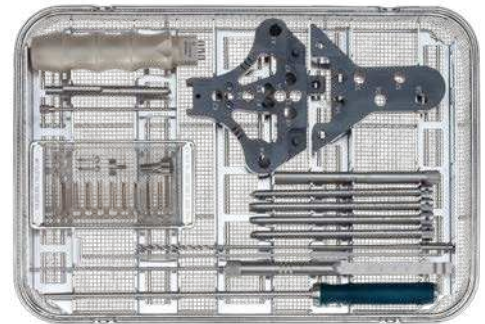

Set no. 19.375.00 Internal hexagon

Item no.	Item description	Quant.
Instruments		
10.270.01	head for aiming device for proximal humerus plates 5.07913.8X	1
10.270.02	shank for aiming device for proximal humerus plates 5.07913.8X	1
10.270.05	connection screw head-shank for aiming device for proximal humerus plates 5.07913.8X	1
10.270.03	handle for aiming device for proximal humerus plates 5.07913.8X	1
10.270.06	fixing screw head-handle for aiming device for proximal humerus plates 5.07913.8X	1
10.270.10	connecting rod for aiming device for proximal humerus plates 5.07913.8X	1
10.270.11	fixing screw for connecting rod for aiming device for proximal humerus plates 5.07913.8X	1
10.270.20	tissue protecting sleeve for aiming device for proximal humerus plates 5.07913.8X	3
10.270.21	troc ar for aiming device for proximal humerus plates 5.07913.8X; length 145 mm	3
10.270.22	drill bush Ø1.6 mm; Ø 10 x 145 mm; IØ 1.7 mm for aiming device for proximal humerus plates 5.07913.8X	3
10.270.23	drill bush Ø 2.5 mm; Ø 10 x 145 mm; IØ 2.7 mm for aiming device for proximal humerus plates 5.07913.8X	3
10.270.24	drill bush Ø 3.0 mm; Ø 10 x 145 mm; IØ 3.2 mm for aiming device for proximal humerus plates 5.07913.8X	3
10.270.30	drill bit for quick coupling; Ø 2.5 x 250 mm; spiral length 60 mm; double spiral; with scaling	2
10.270.31	drill bit for quick coupling; Ø 3.0 x 250 mm; spiral length 60 mm; double spiral; with scaling	2

Item no.	Item description	Quant.
Instruments		
10.270.32	gauge for aiming device for proximal humerus plates 5.07913.8X; measuring range 70 mm	1
10.2705.40	hex screwdriver for Ø 3.5 mm and Ø 4.0 mm; wrench size 2.5 mm; conical; length 315 mm	1
2.952.025	measuring aid f. drill Ø 2.5 mm	1
2.952.030	measuring aid f. drill Ø 3.0 mm	1
10.270.15	blind plug for aiming device for proximal humerus plates 5.07913.8X	10
10.179.15/17	screw head/connection rod for aiming device for proximal humerus plates 5.07913.8X	2

Wire		
6.061.16	Kirschner wire with trocar point and round end, Ø 1.6 x 280 mm, stainless steel	5

Container		
19.374.00	perforated autoclavable container with inset for proximal humerus-guide frame instruments	1

Set Aiming device for VaWiKo® prox. Humerus plate 4.0/3.5

Set no. 19.375.00

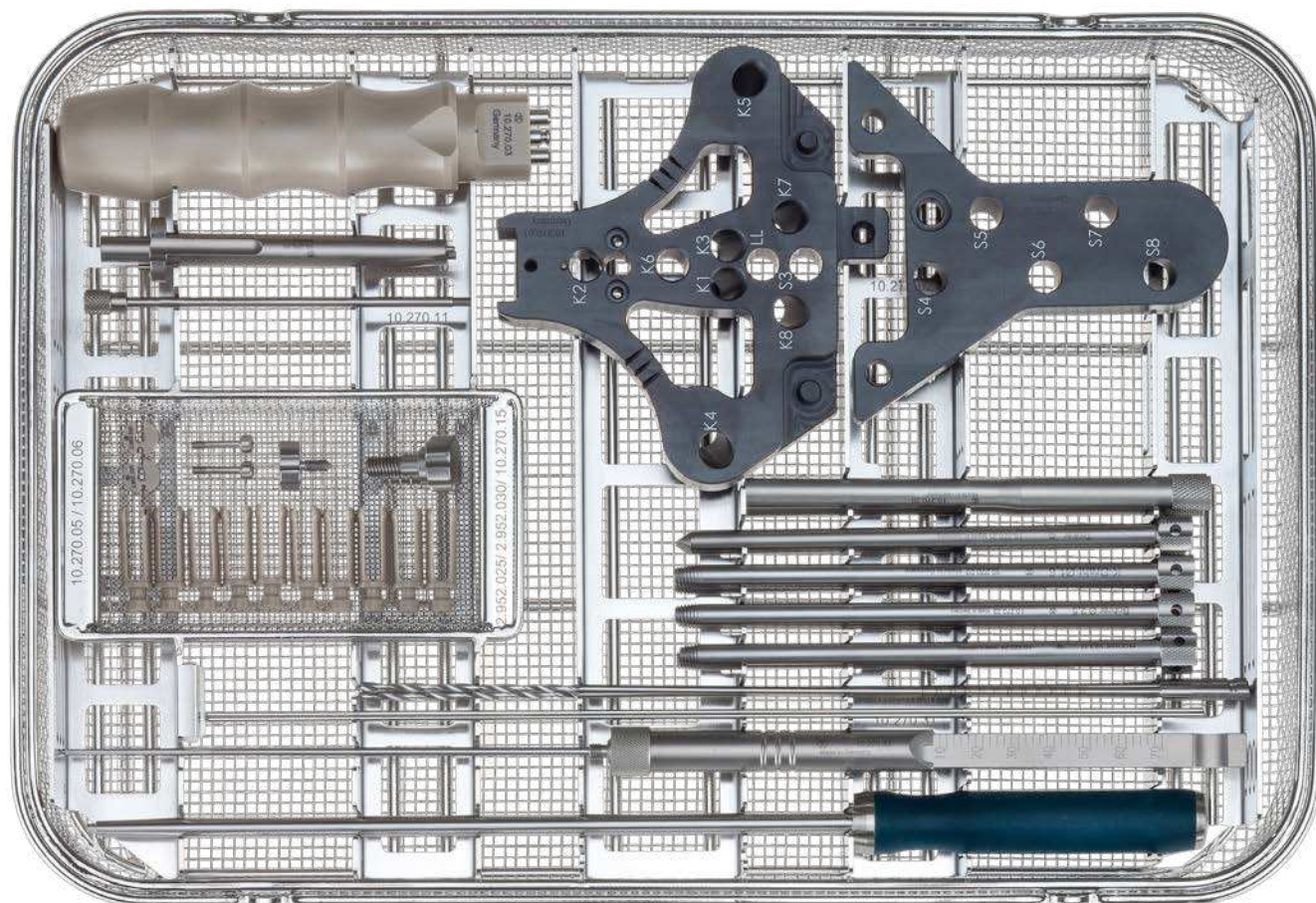

Set no. 19.375.00  Internal hexagon

Information

The system name VaWiKo® is derived from the German designation „Variabel winkelstabile Kombination“, which translates into English as „variable angle-stable combination“. This system combines conventional plating technologies with angle-stable locking in variable angles.

VaWiKo® is a registered trademark of Königsee Implantate GmbH.



Königsee Implantate GmbH
OT Aschau | Am Sand 4
07426 Allendorf | Germany

Fon +49 36738 498-560
Fax +49 36738 498-569

Mail export@koenigsee-implantate.de

For further information please visit:
www.koenigsee-implantate.com

HeBo | Edition 02 | 2019-10
All pictured products are CE compliant.

Proximal Humerus plate 6.0/4.5

angle stable; for screws Ø 6.0/4.5 mm; titanium



Item no. 5.795.07

Item no.	Item description	EAN
Proximal Humerus plate 6.0/4.5; angle stable; titanium		
5.795.05	proximal humerus plate with conical thread 6.0/4.5; 5 holes; 73 mm x 17 mm; titanium	4 047075 008605
5.795.06	proximal humerus plate with conical thread 6.0/4.5; 6 holes; 89 mm x 17 mm; titanium	4 047075 008551
5.795.07	proximal humerus plate with conical thread 6.0/4.5; 7 holes; 105 mm x 17 mm; titanium	4 047075 008629
5.795.08	proximal humerus plate with conical thread 6.0/4.5; 8 holes; 121 mm x 17 mm; titanium	4 047075 008636
5.795.09	proximal humerus plate with conical thread 6.0/4.5; 9 holes; 137 mm x 17 mm; titanium	4 047075 008643
5.795.10	proximal humerus plate with conical thread 6.0/4.5; 10 holes; 153 mm x 17 mm; titanium	4 047075 008650
5.795.11	proximal humerus plate with conical thread 6.0/4.5; 11 holes; 169 mm x 17 mm; titanium	4 047075 008445
5.795.12	proximal humerus plate with conical thread 6.0/4.5; 12 holes; 185 mm x 17 mm; titanium	4 047075 008452
5.795.13	proximal humerus plate with conical thread 6.0/4.5; 13 holes; 201 mm x 17 mm; titanium	4 047075 008698
5.795.14	proximal humerus plate with conical thread 6.0/4.5; 14 holes; 217 mm x 17 mm; titanium	4 047075 008704
5.795.16	proximal humerus plate with conical thread 6.0/4.5; 16 holes; 249 mm x 17mm; titanium	4 047075 167326

Set Proximal Humerus plate 6.0/4.5

angle stable; for screws Ø 6.0/4.5 mm; titanium; Set no. 19.104.00





Item no. 5.795.06



Set no. 19.104.00  Internal hexagon

Item no.	Item description	Quant.
Implants – plates		
Proximal Humerus plate with conical thread; 6.0/4.5; titanium		
5.795.05	5 holes; 73 x 17 mm; titanium	1
5.795.06	6 holes; 89 x 17 mm; titanium	1
5.795.07	7 holes; 105 x 17 mm; titanium	1
5.795.08	8 holes; 121 x 17 mm; titanium	1

Implants – screws		
Cortical screw Ø 4.5 mm; fully threaded; self tapping; titanium		
		
3.152.18	length 18 mm	5
3.152.20	length 20 mm	5
3.152.22	length 22 mm	5
3.152.24	length 24 mm	5
3.152.26	length 26 mm	5
3.152.28	length 28 mm	5
3.152.30	length 30 mm	5
3.152.32	length 32 mm	5
3.152.34	length 34 mm	5
3.152.36	length 36 mm	5
3.152.38	length 38 mm	5
3.152.40	length 40 mm	5
3.152.42	length 42 mm	5
3.152.45	length 45 mm	5
3.152.50	length 50 mm	5

Item no.	Item description	Quant.
Implants – screws		
Cortical screw with conical head thread Ø 4.5 mm; fully threaded; self tapping; titanium		
		
3.545.18	length 18 mm	5
3.545.20	length 20 mm	5
3.545.22	length 22 mm	5
3.545.24	length 24 mm	5
3.545.26	length 26 mm	5
3.545.28	length 28 mm	5
3.545.30	length 30 mm	5
3.545.32	length 32 mm	5
3.545.34	length 34 mm	5
3.545.36	length 36 mm	5
3.545.38	length 38 mm	5
3.545.40	length 40 mm	5
3.545.42	length 42 mm	5
3.545.45	length 45 mm	5
3.545.50	length 50 mm	5

Set Proximal Humerus plate 6.0/4.5

angle stable; for screws Ø 6.0/4.5 mm; titanium; Set no. 19.104.00

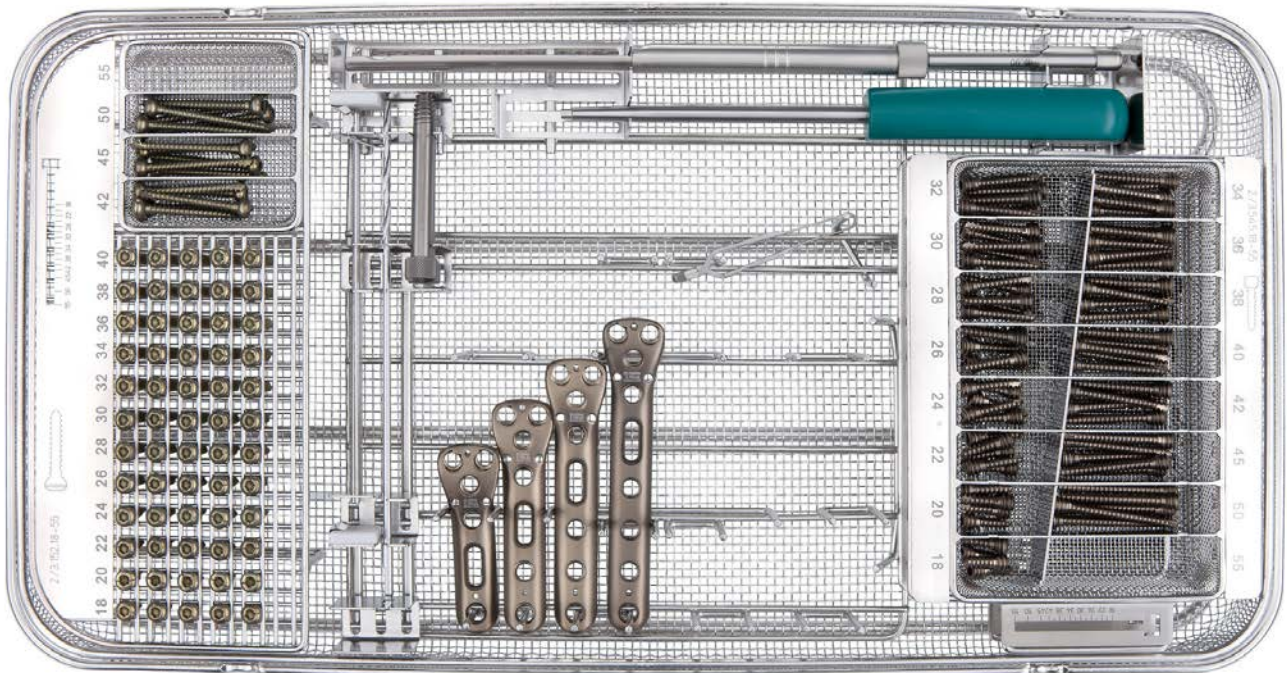

Set no. 19.104.00  Internal hexagon

Item no.	Item description	Quant.
Instruments		
2.904.09	drill bit for quick coupling, Ø 3.2 x 195 mm, spiral length 60 mm, double spiral	1
2.9406.35	hex screwdriver with handle for screws Ø 4.5 mm - Ø 7.0 mm, AF 3.5 mm, length 215 mm	1
2.953.90	gauge with clasp for screws Ø 4.5 mm, Ø 6.0 mm, measuring range 90 mm	1
2.954.01	screw forceps, self holding	1
2.977.02	drill guide for angle stable screwing, length 70 mm, big fragment	2

Wire		
6.031.18	Kirschner wire with trocar point and round end, Ø 1.8 x 150 mm, stainless steel	5

Container		
19.105.00	perforated autoclavable container with inset for instruments/implants humerus-set	1

Item no.	Item description	Quant.
Implants – screws		
Cancellous screw with conical head thread Ø 6.0 mm; fully threaded; self tapping; titanium		
		
3.163.34	length 34 mm	3
3.163.36	length 36 mm	3
3.163.38	length 38 mm	3
3.163.40	length 40 mm	3
3.163.42	length 42 mm	3
3.163.44	length 44 mm	3
3.163.46	length 46 mm	3
3.163.48	length 48 mm	3
3.163.50	length 50 mm	3
3.163.52	length 52 mm	3
3.163.54	length 54 mm	3
3.163.56	length 56 mm	3

Proximal Humerus plate 6.0/4.5

angle stable; for screws Ø 6.0/4.5 mm; stainless steel



Item no. 4.795.06

Item no.	Item description	EAN
Proximal Humerus plate 6.0/4.5; as; stainless steel		
4.795.05	proximal humerus plate with conical thread 6.0/4.5; 5 holes; 73 mm x 17 mm; stainless steel	4 047075 051397
4.795.06	proximal humerus plate with conical thread 6.0/4.5; 6 holes; 89 mm x 17 mm; stainless steel	4 047075 051403
4.795.07	proximal humerus plate with conical thread 6.0/4.5; 7 holes; 105 mm x 17 mm; stainless steel	4 047075 051458
4.795.08	proximal humerus plate with conical thread 6.0/4.5; 8 holes; 121 mm x 17 mm; stainless steel	4 047075 051465
4.795.09	proximal humerus plate with conical thread 6.0/4.5; 9 holes; 137 mm x 17 mm; stainless steel	4 047075 051489
4.795.10	proximal humerus plate with conical thread 6.0/4.5; 10 holes; 153 mm x 17 mm; stainless steel	4 047075 051496
4.795.11	proximal humerus plate with conical thread 6.0/4.5; 11 holes; 169 mm x 17 mm; stainless steel	4 047075 051359
4.795.12	proximal humerus plate with conical thread 6.0/4.5; 12 holes; 185 mm x 17 mm; stainless steel	4 047075 051366
4.795.13	proximal humerus plate with conical thread 6.0/4.5; 13 holes; 201 mm x 17 mm; stainless steel	4 047075 051410
4.795.14	proximal humerus plate with conical thread 6.0/4.5; 14 holes; 217 mm x 17 mm; stainless steel	4 047075 051380

Set Proximal Humerus plate 6.0/4.5

angle stable; for screws Ø 6.0/4.5 mm; stainless steel; set no. 19.103.00



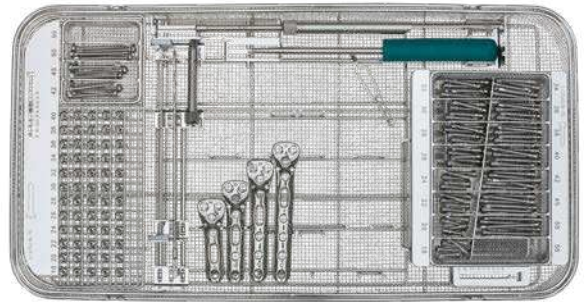

Item no. 4.795.06



Set no. 19.103.00  Internal hexagon

Item no.	Item description	Quant.
Implants – plates		
Proximal humerus plate with conical thread 6.0/4.5; stainless steel		
4.795.05	5 holes; 73 x 17 mm; stainless steel	1
4.795.06	6 holes; 89 x 17 mm; stainless steel	1
4.795.07	7 holes; 105 x 17 mm; stainless steel	1
4.795.08	8 holes; 121 x 17 mm; stainless steel	1

Implants – screws		
Cortical screw Ø 4.5 mm; fully threaded, self tapping; stainless steel		
		
2.152.18	length 18 mm	5
2.152.20	length 20 mm	5
2.152.22	length 22 mm	5
2.152.24	length 24 mm	5
2.152.26	length 26 mm	5
2.152.28	length 28 mm	5
2.152.30	length 30 mm	5
2.152.32	length 32 mm	5
2.152.34	length 34 mm	5
2.152.36	length 36 mm	5
2.152.38	length 38 mm	5
2.152.40	length 40 mm	5
2.152.42	length 42 mm	5
2.152.45	length 45 mm	5
2.152.50	length 50 mm	5

Item no.	Item description	Quant.
Implants – screws		
Cortical screw with conical head thread Ø 4.5 mm; fully threaded, self tapping; stainless steel		
		
2.545.18	length 18 mm	5
2.545.20	length 20 mm	5
2.545.22	length 22 mm	5
2.545.24	length 24 mm	5
2.545.26	length 26 mm	5
2.545.28	length 28 mm	5
2.545.30	length 30 mm	5
2.545.32	length 32 mm	5
2.545.34	length 34 mm	5
2.545.36	length 36 mm	5
2.545.38	length 38 mm	5
2.545.40	length 40 mm	5
2.545.42	length 42 mm	5
2.545.45	length 45 mm	5
2.545.50	length 50 mm	5

Set Proximal Humerus plate 6.0/4.5

angle stable; for screws Ø 6.0/4.5 mm; stainless steel; set no. 19.103.00

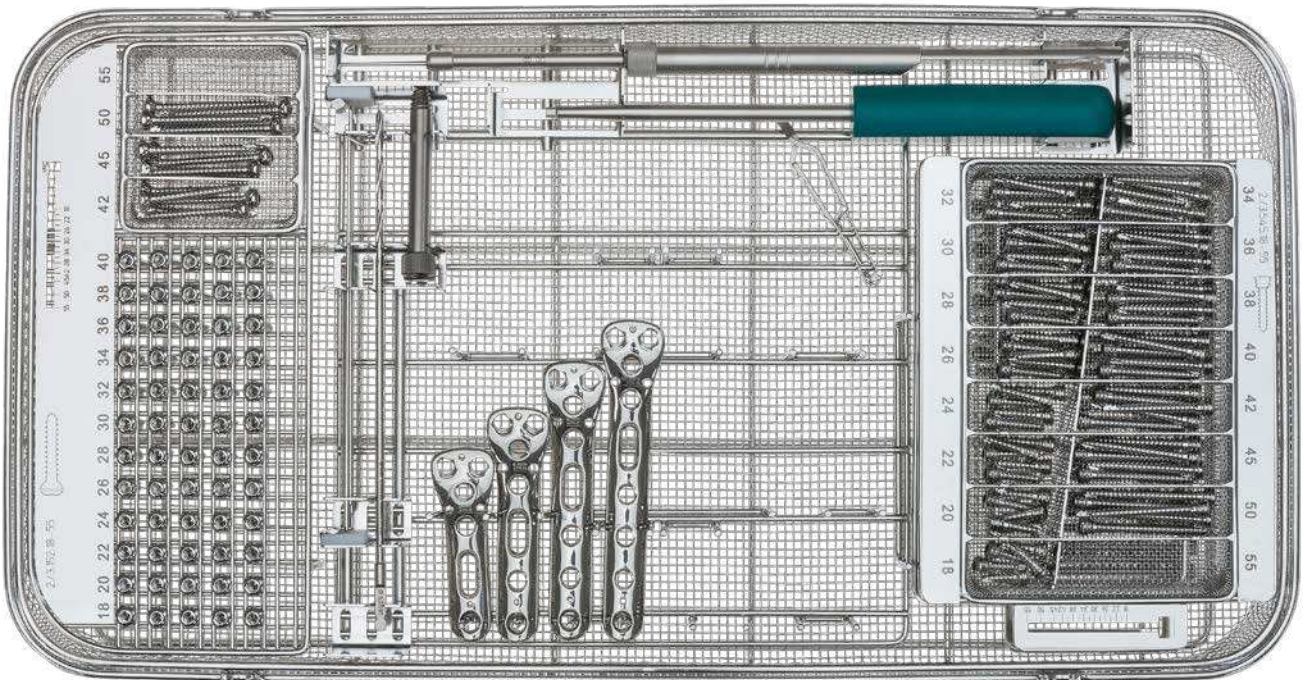

Set no. 19.103.00  Internal hexagon

Item no.	Item description	Quant.
Instruments		
2.904.09	drill bit for quick coupling, Ø 3.2 x 195 mm, spiral length 60 mm, double spiral	1
2.9406.35	hex screwdriver with handle for screws Ø 4.5 mm - Ø 7.0 mm, AF 3.5 mm, length 215 mm	1
2.953.90	gauge with clasp for screws Ø 4.5 mm, Ø 6.0 mm, measuring range 90 mm	1
2.954.01	screw forceps, self holding	1
2.977.02	drill guide for angle stable screwing, length 70 mm, big fragment	2

Wire		
6.031.18	Kirschner wire with trocar point and round end, Ø 1.8 x 150 mm, stainless steel	5

Container		
19.105.00	perforated autoclavable container with inset for instruments/implants humerus-set	1

Item no.	Item description	Quant.
Implants - screws		
Cancellous screw with conical head thread Ø 6.0 mm; fully threaded, self tapping; stainless steel 		
2.163.34	length 34 mm	3
2.163.36	length 36 mm	3
2.163.38	length 38 mm	3
2.163.40	length 40 mm	3
2.163.42	length 42 mm	3
2.163.44	length 44 mm	3
2.163.46	length 46 mm	3
2.163.48	length 48 mm	3
2.163.50	length 50 mm	3
2.163.52	length 52 mm	3
2.163.54	length 54 mm	3
2.163.56	length 56 mm	3

ELBOW

Königsee Implantate

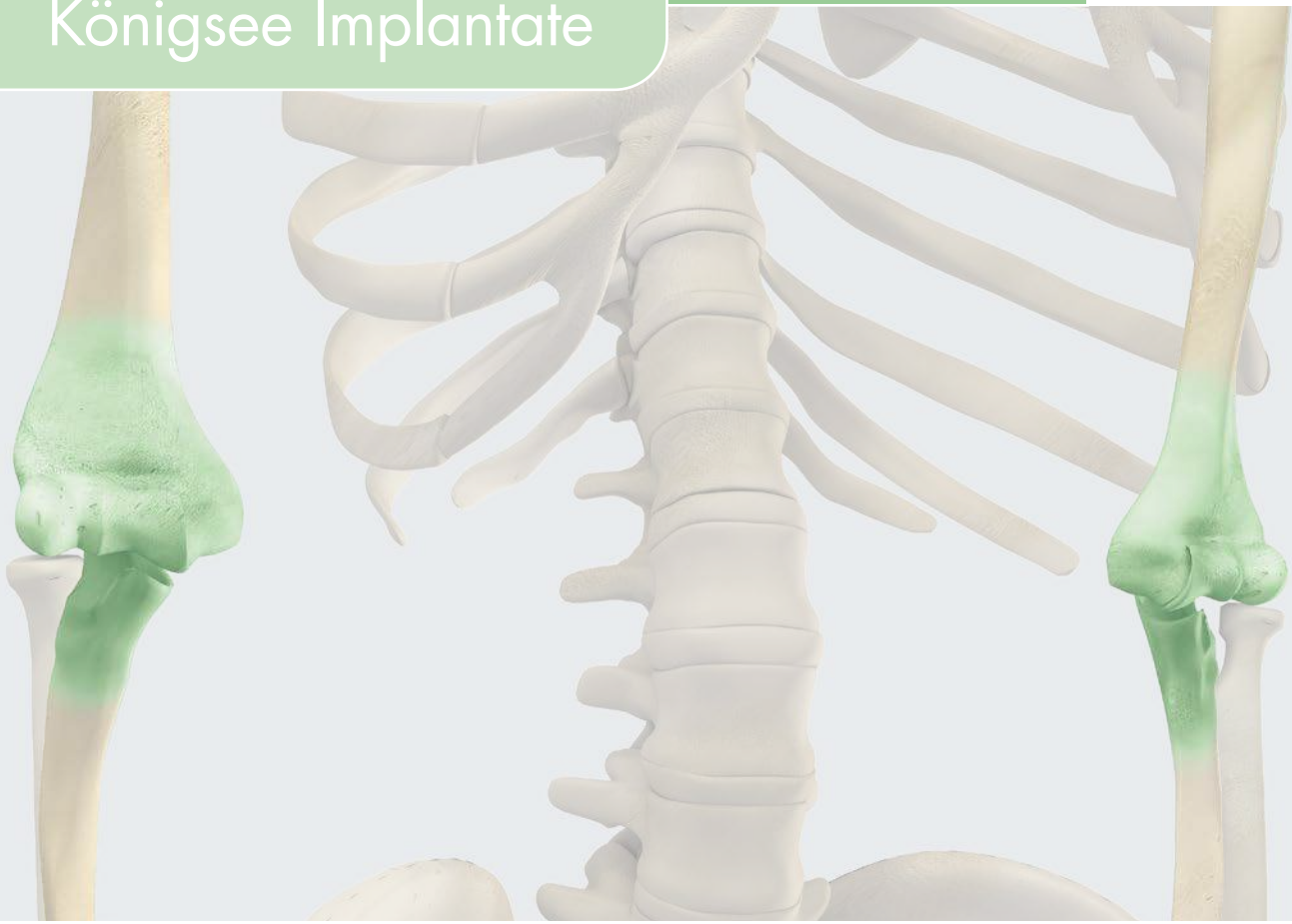

Your Partner in Osteosynthesis

Distal humerus plates

angle-stable; for screws Ø 3.5 mm in head; for screws Ø 4.5 mm in shank; titanium





Item no. 5.8591.85



Item no. 5.8591.86



Item no. 5.8591.88

Item no.	Item description	EAN
5.8591.85	Distal humerus plate with conical thread 3.5 and 4.5; 8/5 holes; length 141 mm; titanium	 4 047075 161225
5.8591.86	Distal humerus plate with conical thread 3.5 and 4.5; 8/6 holes; length 169 mm; titanium	 4 047075 161232
5.8591.88	Distal humerus plate with conical thread 3.5 and 4.5; 8/8 holes; length 199 mm; titanium	 4 047075 161249

OP-set combined 3.5/4.5 for angle-stable distal humerus plates

with instruments and screws; titanium; Set no. 19.675.010



Item no. 5.8591.85



Item no. 5.8591.86



Item no. 5.8591.88

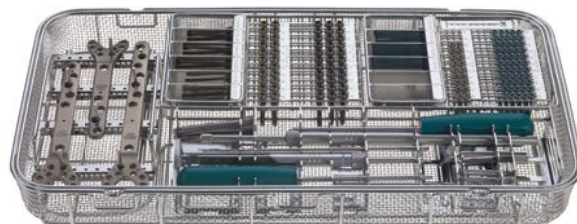

Set no. 19.675.010

Internal hexagon

Elbow

Item no.	Item description	Quant.
Implants – plates		
Distal humerus plates with conical thread 3.5 and 4.5; titanium		
5.8591.85	Distal humerus plate with conic thread 3.5/4.5; 8/5 holes; length 141 mm	1
5.8591.86	Distal humerus plate with conic thread 3.5/4.5; 8/6 holes; length 169 mm	1
5.8591.88	Distal humerus plate with conic thread 3.5/4.5; 8/8 holes; length 199 mm	1

Instruments for small fragment		
2.9406.25	hex screwdriver with handle for screws Ø 2.7mm - Ø 4.0 mm, AF 2.5 mm, conical	1
2.953.60	gauge with clasp for screws Ø 3.5mm, Ø 4.0mm, measuring range 60mm	1
2.904.06	drill bit for quick coupling, Ø 2.5 x 125 mm, spiral length 60 mm, double spiral	1
2.977.01	drill guide for angle stable screwing, length 45 mm, small fragment	2

Instruments for large fragment		
2.9406.35	hex screwdriver with handle for screws Ø 4.5 mm - Ø 7.0 mm, AF 3.5 mm, length 215 mm	1
2.953.90	gauge with clasp for screws Ø 4.5 mm, Ø 6.0 mm, measuring range 90 mm	1
2.904.09	drill bit for quick coupling, Ø 3.2 x 195 mm, spiral length 60 mm, double spiral	1
2.977.02	drill guide for angle stable screwing, length 70 mm, large fragment	2

Instrument for large fragment and small fragment		
2.954.01	screw forceps, self holding	1

Wires		
6.031.20	Kirschner wire with trocar point and round end, Ø 2.0 x 150 mm, stainless steel	5

Item no.	Item description	Quant.
Implants - screws		
Cortical screw with conical head thread; Ø 3.5 mm; fully threaded; self tapping; titanium		
3.133.20	length 20 mm	5
3.133.22	length 22 mm	5
3.133.24	length 24 mm	5
3.133.26	length 26 mm	5
3.133.28	length 28 mm	5
3.133.30	length 30 mm	5
3.133.32	length 32 mm	5
3.133.34	length 34 mm	5
3.133.36	length 36 mm	5
3.133.38	length 38 mm	5
3.133.40	length 40 mm	5
3.133.42	length 42 mm	5
3.133.45	length 45 mm	5
3.133.50	length 50 mm	5

Cortical screw Ø 3.5 mm; fully threaded; self tapping; titanium		
3.132.24	length 24 mm	2
3.132.26	length 26 mm	2
3.132.28	length 28 mm	2
3.132.30	length 30 mm	2
3.132.32	length 32 mm	2
3.132.34	length 34 mm	2
3.132.36	length 36 mm	2
3.132.38	length 38 mm	2
3.132.40	length 40 mm	2

OP-Set Kombi 3.5/4.5 für winkelstabile distale Humerusplatten mit Instrumenten und Schrauben; Titan; Set-Nr. 19.675.010

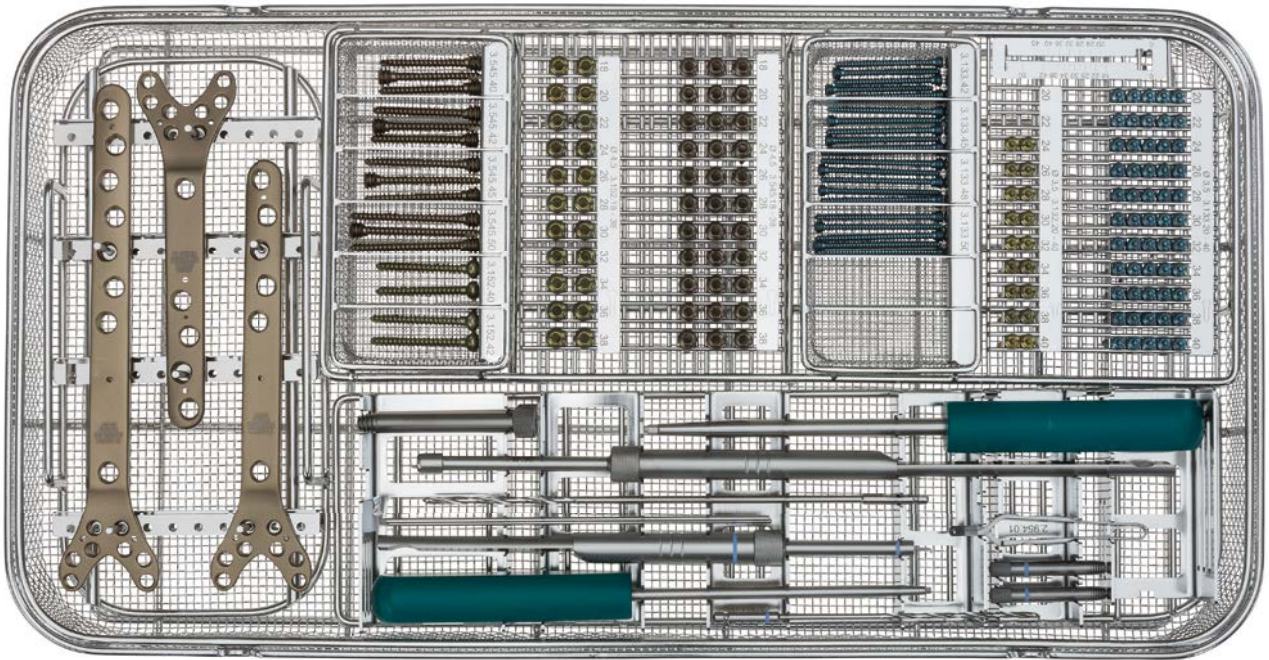

Set-Nr. 19.675.010

 Innensechskant

Art.-Nr.	Bezeichnung	Menge
Siebkorb		
19.674.010	Siebkorb mit Einsatz für Instrumente/ Implantate distale Humerusplatten, winkel- stabil, KF/GF, Titan	1

Implantate - Schrauben		
Kortikalisschraube Ø 4.5 mm; Vollgewinde; selbstschneidend; Titan 		
3.152.18	Länge 18 mm	2
3.152.20	Länge 20 mm	2
3.152.22	Länge 22 mm	2
3.152.24	Länge 24 mm	2
3.152.26	Länge 26 mm	2
3.152.28	Länge 28 mm	2
3.152.30	Länge 30 mm	2
3.152.32	Länge 32 mm	2
3.152.34	Länge 34 mm	2
3.152.36	Länge 36 mm	2
3.152.38	Länge 38 mm	2
3.152.40	Länge 40 mm	2
3.152.42	Länge 42 mm	2

Art.-Nr.	Bezeichnung	Menge
Implantate - Schrauben		
Kortikalisschraube mit konischem Kopfgewinde; Ø 4.5 mm; Vollgewinde; selbstschneidend; Titan 		
3.545.18	Länge 18 mm	3
3.545.20	Länge 20 mm	3
3.545.22	Länge 22 mm	3
3.545.24	Länge 24 mm	3
3.545.26	Länge 26 mm	3
3.545.28	Länge 28 mm	3
3.545.30	Länge 30 mm	3
3.545.32	Länge 32 mm	3
3.545.34	Länge 34 mm	3
3.545.36	Länge 36 mm	3
3.545.38	Länge 38 mm	3
3.545.40	Länge 40 mm	3
3.545.42	Länge 42 mm	3
3.545.45	Länge 45 mm	3
3.545.50	Länge 50 mm	3



Königsee Implantate

Königsee Implantate GmbH
OF-Aschau / Am Sand 4
D-07426 Allendorf/Germany
Tel.: +49 36738 498-0
Fax: +49 36738 498-19
Web: www.koenigsee-implantate.de
Mail: info@koenigsee-implantate.de

Angle-stable distal humerus plates

radial/lateral without extension for screws Ø 3.5 mm; titanium

Item no.	Item description
Right	
5.8542.44	distal humerus plate with conical thread 3.5; 4/4 holes; length 78 mm; lateral without extension
5.8542.46	distal humerus plate with conical thread 3.5; 4/6 holes; length 102 mm; lateral without extension
5.8542.48	distal humerus plate with conical thread 3.5; 4/8 holes; length 126 mm; without extension
5.8542.410	distal humerus plate with conical thread 3.5; 4/10 holes; length 150 mm; without extension
Left	
5.8552.44	distal humerus plate with conical thread 3.5; 4/4 holes; length 78 mm; lateral without extension
5.8552.46	distal humerus plate with conical thread 3.5; 4/6 holes; length 102 mm; lateral without extension
5.8552.48	distal humerus plate with conical thread 3.5; 4/8 holes; length 126 mm; lateral without extension
5.8552.410	distal humerus plate with conical thread 3.5; 4/10 holes; length 150 mm; lateral without extension



We hope, this offer meets your expectations
and we would be happy to receive your order.

With kind regards

Königsee Implantate GmbH

Königsee Implantate GmbH

25/07/2013/KaMo



Königsee Implantate

Königsee Implantate GmbH
OFAschau / Am Sand 4
07426 Allendorf /Germany
Tel.: +49 36738 498-0
Fax: +49 36738 498-19
Web: www.koenigsee-implantate.de
Mail: info@koenigsee-implantate.de

Angle-stable distal humerus plate radial/lateral with extensions for screws D 3.5 mm; titanium

item no.	item description
Rechts	
5.8522.54	Distal humerus plate with conical thread 3.5 5/4 holes; length 78 mm; lateral with extensions
5.8522.56	Distal humerus plate with conical thread 3.5 5/6 holes; length 102 mm; lateral with extensions
5.8522.58	Distal humerus plate with conical thread 3.5 5/8 holes; length 126 mm; lateral with extensions
5.8522.510	Distal humerus plate with conical thread 3.5 5/10 holes; length 150 mm; lateral with extensions
Links	
5.8532.54	Distal humerus plate with conical thread 3.5 5/4 holes; length 78 mm; lateral with extensions
5.8532.56	Distal humerus plate with conical thread 3.5 5/6 holes; length 102 mm; lateral with extensions
5.8532.58	Distal humerus plate with conical thread 3.5 5/8 holes; length 126 mm; lateral with extensions
5.8532.510	Distal humerus plate with conical thread 3.5 5/10 holes; length 150 mm; lateral with extensions



We hope, this offer meets your expectations
and we would be happy to receive your order.

With kind regards

Königsee Implantate GmbH



Königsee Implantate

Königsee Implantate GmbH
OT-Aschau / Am Sand 4
D-07426 Allendorf/Germany
Tel.: +49 36738 498-0
Fax: +49 36738 498-19
Web: www.koenigsee-implantate.de
Mail: info@koenigsee-implantate.de

Variable angle-stable distal humerus plates ulnar/medial for screws Ø 3.5 mm; titanium

Item no.	Item description
Right	
5.8563.44	distal humerus plate with conical thread 3.5; 4/4 holes; length 76 mm; medial
5.8563.46	distal humerus plate with conical thread 3.5; 4/6 holes; length 100 mm; medial
5.8563.48	distal humerus plate with conical thread 3.5; 4/8 holes; length 124 mm; medial
5.8563.410	distal humerus plate with conical thread 3.5; 4/10 holes; length 148 mm; medial
Left	
5.8573.44	distal humerus plate with conical thread 3.5; 4/4 holes; length 76 mm; medial
5.8573.46	distal humerus plate with conical thread 3.5; 4/6 holes; length 100 mm; medial
5.8573.48	distal humerus plate with conical thread 3.5; 4/8 holes; length 124 mm; medial
5.8573.410	distal humerus plate with conical thread 3.5; 4/10 holes; length 148 mm; medial

pic.: 5.8573.46

pic.: 5.8563.46

We hope, this offer meets your expectations
and we would be happy to receive your order.

With kind regards

Königsee Implantate GmbH

Königsee Implantate GmbH

25/07/2013/KaMo



Königsee Implantate

Königsee Implantate GmbH
OT-Aschau / Am Sand 4
07426 Allendorf / Germany
Tel.: +49 36738 498-0
Fax: +49 36738 498-19
Web: www.koenigsee-implantate.de
Mail: info@koenigsee-implantate.de

Variable angle-stable olecranon plate

with claw and conical thread 3.5; small fragment; titanium

Item no.	Item description
<u>With claw</u>	
5.08743.08	Olecranon plate with claw and conical thread 3.5 8 holes, length 76 mm; variable angle-stable
5.08743.10	Olecranon plate with claw and conical thread 3.5 10 holes, length 99 mm; variable angle-stable
5.08743.14	Olecranon plate with claw and conical thread 3.5 14 holes, length 151 mm; variable angle-stable
<u>Without claw</u>	
5.08753.08	Olecranon plate without claw and conical thread 3.5 8 holes, length 76 mm; variable angle-stable
5.08753.10	Olecranon plate without claw and conical thread 3.5 10 holes, length 99 mm; variable angle-stable
5.08753.14	Olecranon plate without claw and conical thread 3.5 14 holes, length 151 mm; variable angle-stable



We hope, this offer meets your expectations
and we would be happy to receive your order.

With kind regards

Königsee Implantate GmbH
Königsee Implantate GmbH

25/07/2013/KaMo

Olecranon Plate 3.5 spike

standard; with spikes; plate thickness 2.0 mm; for screws Ø 3.5 mm; titanium



Item no. 5.874.04



Item no. 5.874.06



Item no. 5.874.10

Item no.	Item description	EAN
5.874.04	olecranon plate with spikes 3.5; 4 holes; 68 x 10 mm; spikes radius 6; titanium	 4047075010837
5.874.05	olecranon plate with spikes 3.5; 5 holes; 80 x 10 mm; spikes radius 6; titanium	 4047075010844
5.874.06	olecranon plate with spikes 3.5; 6 holes; 92 x 10 mm; spikes radius 6; titanium	 4047075010912
5.874.07	olecranon plate with spikes 3.5; 7 holes; 104 x 10 mm; spikes radius 6; titanium	 4047075010929
5.874.08	olecranon plate with spikes 3.5; 8 holes; 116 x 10 mm; spikes radius 6; titanium	 4047075010943
5.874.09	olecranon plate with spikes 3.5; 9 holes; 128 x 10 mm; spikes radius 6; titanium	 4047075010714
5.874.10	olecranon plate with spikes 3.5; 10 holes; 140 x 10 mm; spikes radius 6; titanium	 4047075010721
5.874.12	olecranon plate with spikes 3.5; 12 holes; 164 x 10 mm; spikes radius 6; titanium	 4047075010981
5.874.14	olecranon plate with spikes 3.5; 14 holes; 188 x 10 mm; spikes radius 6; titanium	 4047075010998

Olecranon Plate 3.5 spike

standard; with spikes; plate thickness 2.0 mm; for screws Ø 3.5 mm; stainless steel



Item no. 4.874.04



Item no. 4.874.06



Item no. 4.874.08

Item no.	Item description	EAN
4.874.04	olecranon plate with spikes 3.5; 4 holes; 68 x 10 mm; spikes radius 6; stainless steel	 4047075048427
4.874.05	olecranon plate with spikes 3.5; 5 holes; 80 x 10 mm; spikes radius 6; stainless steel	 4047075048243
4.874.06	olecranon plate with spikes 3.5; 6 holes; 92 x 10 mm; spikes radius 6; stainless steel	 4047075048250
4.874.07	olecranon plate with spikes 3.5; 7 holes; 104 x 10 mm; spikes radius 6; stainless steel	 4047075048328
4.874.08	olecranon plate with spikes 3.5; 8 holes; 116 x 10 mm; spikes radius 6; stainless steel	 4047075048281
4.874.09	olecranon plate with spikes 3.5; 9 holes; 128 x 10 mm; spikes radius 6; stainless steel	 4047075048342



Königsee Implantate

Königsee Implantate GmbH
OT-Aschau / Am Sand 4
07426 Allendorf /Germany
Tel.: +49 36738 498-0
Fax: +49 36738 498-19
Web: www.koenigsee-implantate.de
Mail: info@koenigsee-implantate.de

Olecranon plate with spikes and extended head 110°; small fragment; titanium

Item no.	Item description
5.869.06	Olecranon plate with spikes and extended head 110°; 6 holes; titanium
5.869.08	Olecranon plate with spikes and extended head 110°; 8 holes; titanium
5.869.10	Olecranon plate with spikes and extended head 110°; 10 holes; titanium
5.869.12	Olecranon plate with spikes and extended head 110°; 12 holes; titanium



We hope, this offer meets your expectations
and we would be happy to receive your order.

With kind regards

Königsee Implantate GmbH

Königsee Implantate GmbH

25/07/2013/KaMo

„Elbow“ set - Distal Humerus- and Olecranon plates

angel-stable; for screws 3.5; titanium, set no. 19.551.00

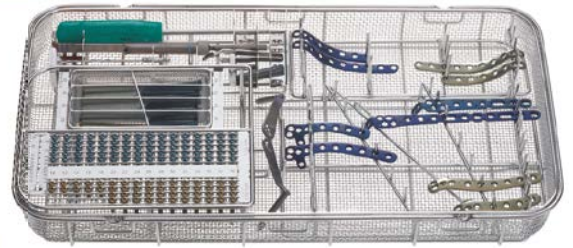

item description	item no.	quantity
Implants		
<u>Distal humerus plates, small fragment, titanium</u>		
5/4 holes, for screws Ø 3.5; length 78 mm, lat.with extension, right	5.8522.54	1
5/6 holes, for screws Ø 3.5; length 102 mm, lat.with extension, right	5.8522.56	1
5/4 holes, for screws Ø 3.5; length 78 mm, lat.with extension, left	5.8532.54	1
5/6 holes, for screws Ø 3.5; length 102 mm, lat.with extension, left	5.8532.56	1
<u>Variable angle-stable olecranon plates, small fragment, titanium</u>		
olecranon plate with claw, 10 holes, length 99 mm	5.08743.10	1
olecranon plate with claw, 14 holes, length 151 mm	5.08743.14	1

Instruments		
drill bit f. quick coupling, Ø 2.5 x 125, spiral length 60, double spiral	2.904.06	1
drill guide for angle stable screwing, length 45, small fragment	2.977.01	2
drill guide w. handle for variable angle stable screwing, SF, length 45	2.977.08	1
drill guide with handle for small fragment, handle length 55	10.500.27A	1
hex screwdriver with handle for screws Ø2.7 - 4.0, AF 2.5, conical	2.9406.25	1
gauge w. clasp f.screws w. con. head thread Ø3.5, Ø4.0, MR 60	2.953.60	1
screw forceps, self holding	2.954.01	1

Container		
perforated autoclavable container with insert for instruments and implants for the elbow	19.550.00	1

Wire		
Kirschner wire with trocar point and round end, Ø 1.6 x 150, st.st.	6.031.16	5

item description	item no.	quantity
Angel-stable cortical screws		
conical head thread, fully threaded, Ø 3.5 mm, self-tapping, titanium 		
length 10 mm	3.133.10	5
length 12 mm	3.133.12	5
length 14 mm	3.133.14	5
length 16 mm	3.133.16	5
length 18 mm	3.133.18	5
length 20 mm	3.133.20	5
length 22 mm	3.133.22	5
length 24 mm	3.133.24	5
length 26 mm	3.133.26	5
length 28 mm	3.133.28	5
length 30 mm	3.133.30	5
length 32 mm	3.133.32	5
length 34 mm	3.133.34	5
length 36 mm	3.133.36	5
length 38 mm	3.133.38	5
length 40 mm	3.133.40	5
length 45 mm	3.133.45	5
length 50 mm	3.133.50	5
length 55 mm	3.133.55	5
length 60 mm	3.133.60	5

Cortical screws		
fully threaded, self-tapping, titanium 		
Ø 3.5 mm		
length 10 mm	3.132.10	2
length 12 mm	3.132.12	2
length 14 mm	3.132.14	2
length 16 mm	3.132.16	2
length 18 mm	3.132.18	2
length 20 mm	3.132.20	4
length 22 mm	3.132.22	4
length 24 mm	3.132.24	4
length 26 mm	3.132.26	4
length 28 mm	3.132.28	4
length 30 mm	3.132.30	4
length 32 mm	3.132.32	4
length 34 mm	3.132.34	4
length 36 mm	3.132.36	4
length 38 mm	3.132.38	4
length 40 mm	3.132.40	4
length 45 mm	3.132.45	2
length 50 mm	3.132.50	2
length 55 mm	3.132.55	2
length 60 mm	3.132.60	2

OP set „elbow“ - distal humerus- and olecranon plates

angel-stable, for screws 3.5, small fragment, titanium, complete set item no. 19.551.00

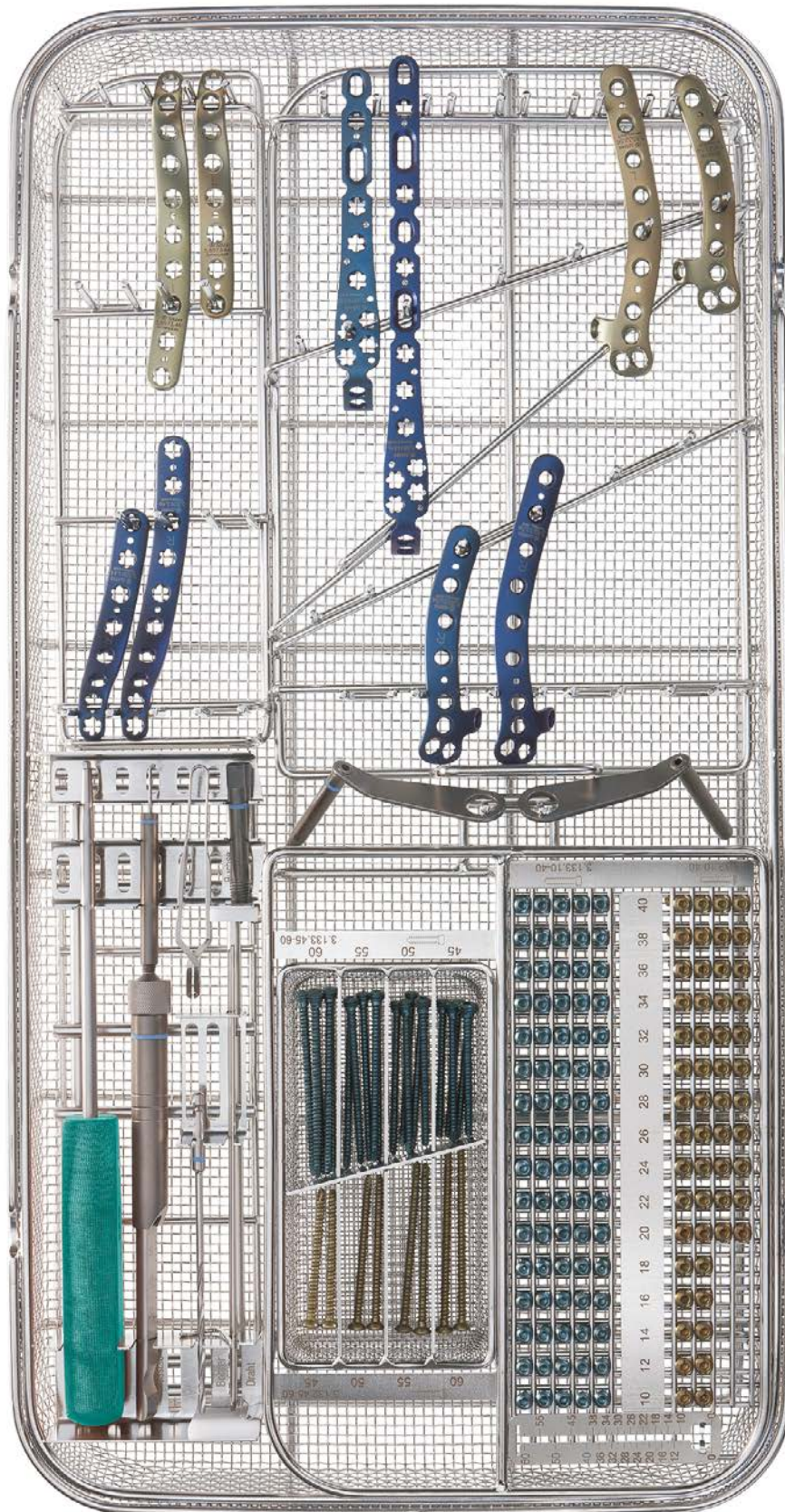

RADIUS

Königsee Implantate

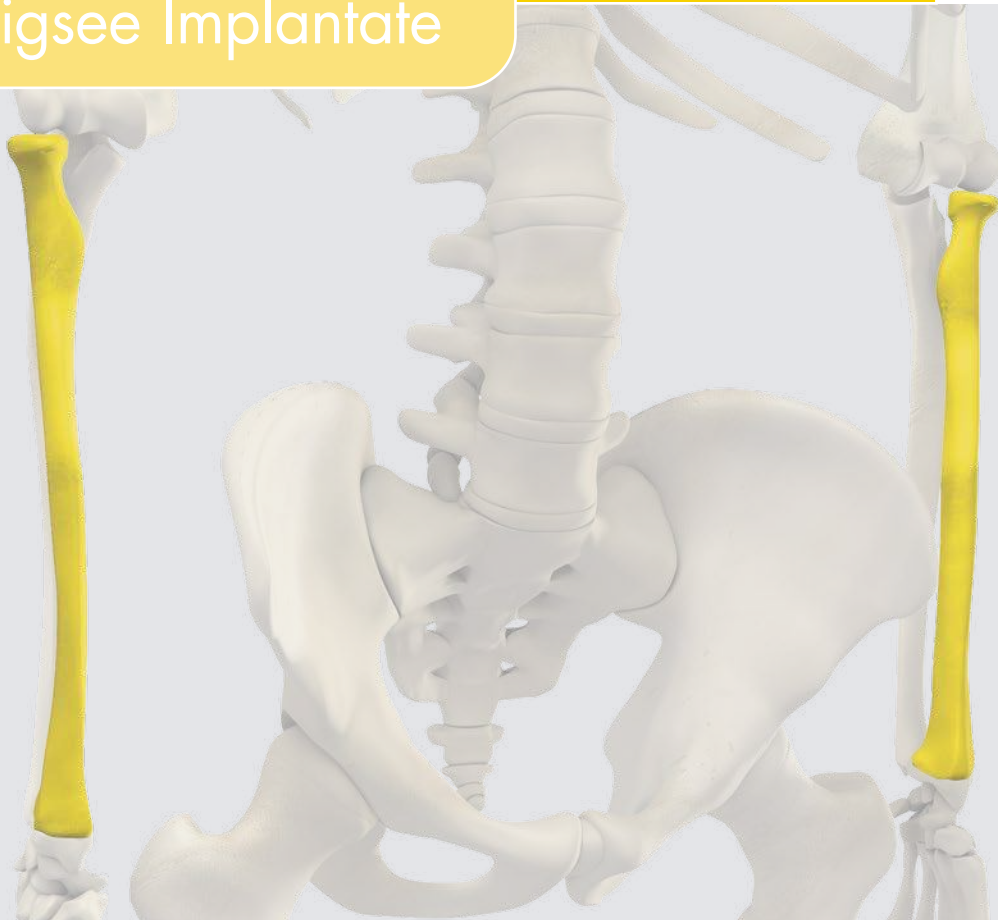

Your Partner in Osteosynthesis

Angle-stable Distal and Proximal Radius Plates 2.0

Dorsal and Palmar for Screws \varnothing 2.0/3.5 mm; Proximal for Screws \varnothing 2.0/2.0 mm; Titanium



Item no.	Item description
----------	------------------

Distal dorsal radius plate with conical thread in head \varnothing 2.0/3.5 mm; titanium

5.892.43	distal radius plate with conical thread in head \varnothing 2.0/3.5 mm; 4/3 holes; 63 x 10 mm; dorsal; right; titanium
5.892.53	distal radius plate with conical thread in head \varnothing 2.0/3.5 mm; 5/3 holes; 63 x 10 mm; dorsal; right; titanium
5.893.43	distal radius plate with conical thread in head \varnothing 2.0/3.5 mm; 4/3 holes; 63 x 10 mm; dorsal; left; titanium
5.893.53	distal radius plate with conical thread in head \varnothing 2.0/3.5 mm; 5/3 holes; 63 x 10 mm; dorsal; left; titanium

Distal palmar radius plate with conical thread in head \varnothing 2.0/3.5 mm; titanium

5.898.63	distal radius plate with conical thread in head \varnothing 2.0/3.5 mm; 6/3 holes; 50 x 10 mm; palmar; right; titanium
5.898.65	distal radius plate with conical thread in head \varnothing 2.0/3.5 mm; 6/5 holes; 67 x 10 mm; palmar; right; titanium
5.899.63	distal radius plate with conical thread in head \varnothing 2.0/3.5 mm; 6/3 holes; 50 x 10 mm; palmar; left; titanium
5.899.65	distal radius plate with conical thread in head \varnothing 2.0/3.5 mm; 6/5 holes; 67 x 10 mm; palmar; left; titanium
5.8985.63	distal radius plate with conical thread in head \varnothing 2.0/3.5 mm; 6/3 holes; 50 x 10 mm; palmar; right; titanium
5.8995.63	distal radius plate with conical thread in head \varnothing 2.0/3.5 mm; 6/3 holes; 50 x 10 mm; palmar; left; titanium

Proximal radius plate with conical thread in head \varnothing 2.0/2.0 mm; titanium

5.884.23	proximal radius plate with conical thread in head \varnothing 2.0/2.0 mm; 2/3 holes; 32 x 7.0 mm; titanium
5.884.24	proximal radius plate with conical thread in head \varnothing 2.0/2.0 mm; 2/4 holes; 40 x 7.0 mm; titanium

Set Angle-stable Distal Radius Plates 2.0

Dorsal and Palmar; for Screws Ø 2.0/3.5 mm; Titanium; Set no. 19.436.00



Item no. 5.893.53



Item no. 5.898.63

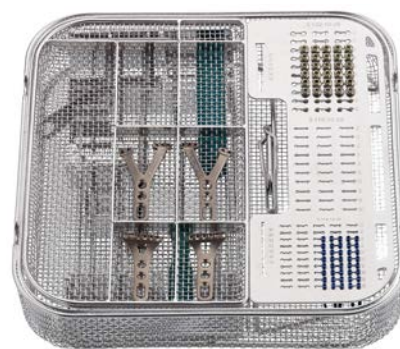

Internal hexagon Set no. 19.436.00

Item no.	Item description	Quant.
Implants - plates		
Distal radius plate with conical thread in head Ø 2.0/3.5 mm		
5.892.53	5/3 holes; 63 x 10 mm; dorsal; right; titanium	1
5.893.53	5/3 holes; 63 x 10 mm; dorsal; left; titanium	1
5.898.63	6/3 holes; 50 x 10 mm; palmar; right; titanium	1
5.899.63	6/3 holes; 50 x 10 mm; palmar; left; titanium	1

Instruments		
2.904.05	drill bit for quick coupling; Ø 2.5 x 105 mm; spiral length 50 mm; double spiral	1
2.904.20	drill bit for quick coupling; Ø 1.5 x 105 mm; spiral length 30 mm; double spiral	1
2.9401.15A	hex screwdriver with handle for screw Ø 1.5 mm and Ø 2.0 mm; wrench width 1.5 mm; detachable	1
2.9406.25	hex screwdriver with handle for screws Ø 2.7 - Ø 4.0 mm; AF 2.5 mm; conical; PPSU	1
2.948.15A	screwdriver for extraction for quick coupling; wrench size 1.5 mm	1
2.953.51	gauge with clasp for screws with conical head thread Ø 2.0 mm; measuring range 44 mm	1
2.954.01	screw forceps; self holding	1
2.977.06	drill guide for angle stable screwing 2.0; length 45 mm	2
10.500.27A	drill guide with handle for small fragment; handle length 55 mm	1

Wire		
6.031.14	Kirschner wire with trocar point and round end; Ø 1.4 x 150 mm; stainless steel	5

Item no.	Item description	Quant.
Implants - screws		
Cortical screw with conical head thread and depth stop Ø 2.0 mm; fully threaded self tapping; titanium		
3.114.16	length 16 mm	5
3.114.18	length 18 mm	5
3.114.20	length 20 mm	5
3.114.22	length 22 mm	5
3.114.24	length 24 mm	5
3.114.26	length 26 mm	5
3.114.28	length 28 mm	5
3.114.30	length 30 mm	5

Cortical screw Ø 3.5 mm fully threaded self tapping titanium		
3.132.14	length 14 mm	5
3.132.16	length 16 mm	5
3.132.18	length 18 mm	5
3.132.20	length 20 mm	5
3.132.22	length 22 mm	5
3.132.24	length 24 mm	5

Container		
19.435.00	perforated autoclavable container with inset for instruments and radius plates	1

Set Angle-stable Distal Radius Plates 2.0

Dorsal and Palmar; for Screws \varnothing 2.0/3.5 mm; Titanium; Set no. 19.436.00

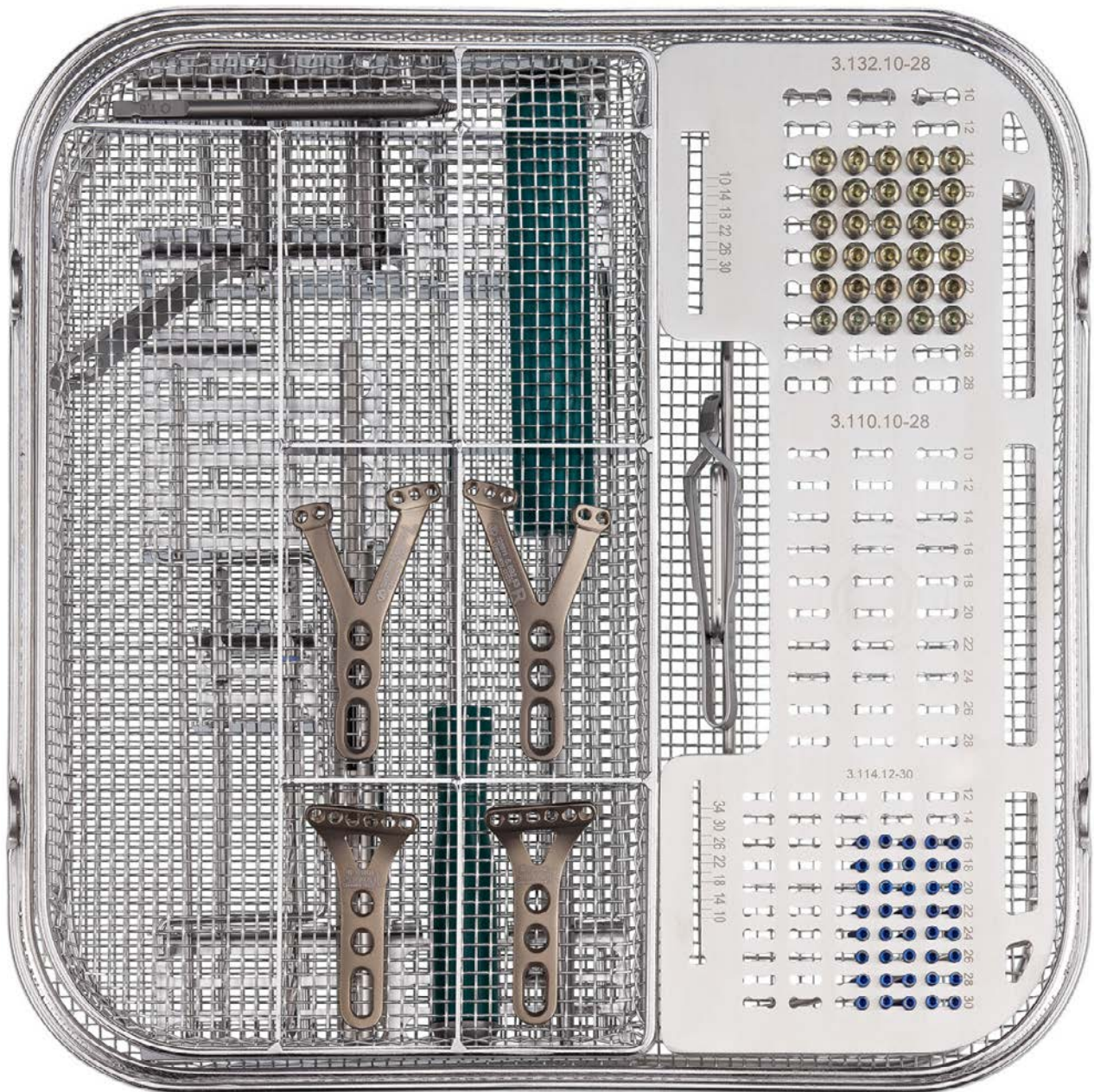

Radius

Internal hexagon Set no. 19.436.00

Distal Radius Plate 2.4 vas

variable angle-stable; for screws \varnothing 2.4 mm; Titanium



Item no. 5.08173.06























Item no. 5.08193.06

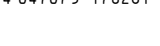

Item no. 5.08273.06



Item no. 5.08293.06

Item no.	Item description	EAN
5.08173.02	dist.radius plate 2.4; 7/2 holes; 23x46mm; narrow; vas; left	 4 047075 178063
5.08173.03	dist.radius plate 2.4; 7/3 holes; 23x55mm; narrow; vas; left	 4 047075 178070
5.08173.04	dist.radius plate 2.4; 7/4 holes; 23x63mm; narrow; vas; left	 4 047075 178087
5.08173.06	dist.radius plate 2.4; 7/6 holes; 23x80mm; narrow; vas; left	 4 047075 178094
5.08173.08	dist.radius plate 2.4; 7/8 holes; 23x97mm; narrow; vas; left	 4 047075 178100
5.08173.10	dist.radius plate 2.4; 7/10 holes; 23x114mm; narrow; vas; left	 4 047075 178117
5.08173.12	dist.radius plate 2.4; 7/12 holes; 23x131mm; narrow; vas; left	 4 047075 178124
5.08273.02	dist.radius plate 2.4; 7/2 holes; 23x46mm; narrow; vas; right	 4 047075 178209
5.08273.03	dist.radius plate 2.4; 7/3 holes; 23x55mm; narrow; vas; right	 4 047075 178216
5.08273.04	dist.radius plate 2.4; 7/4 holes; 23x63mm; narrow; vas; right	 4 047075 178223
5.08273.06	dist.radius plate 2.4; 7/6 holes; 23x80mm; narrow; vas; right	 4 047075 178230
5.08273.08	dist.radius plate 2.4; 7/8 holes; 23x97mm; narrow; vas; right	 4 047075 178247
5.08273.10	dist.radius plate 2.4; 7/10 holes; 23x114mm; narrow; vas; right	 4 047075 178254
5.08273.12	dist.radius plate 2.4; 7/12 holes; 23x131mm; narrow; vas; right	 4 047075 178261
5.08193.02	dist.radius plate 2.4; 9/2 holes; 28x46mm; broad; vas; left	 4 047075 178131
5.08193.03	dist.radius plate 2.4; 9/3 holes; 28x55mm; broad; vas; left	 4 047075 178148
5.08193.04	dist.radius plate 2.4; 9/4 holes; 28x63mm; broad; vas; left	 4 047075 178155
5.08193.06	dist.radius plate 2.4; 9/6 holes; 28x80mm; broad; vas; left	 4 047075 178162
5.08193.08	dist.radius plate 2.4; 9/8 holes; 28x97mm; broad; vas; left	 4 047075 178179
5.08193.10	dist.radius plate 2.4; 9/10 holes; 28x114mm; broad; vas; left	 4 047075 178186
5.08193.12	dist.radius plate 2.4; 9/12 holes; 28x131mm; broad; vas; left	 4 047075 178193

Distal Radius Plate 2.4 vas

variable angle-stable; for screws \varnothing 2.4 mm; Titanium

Item no.	Item description	EAN
5.08293.02	dist.radius plate 2.4; 9/2 holes; 28x46mm; broad; vas; right	 4 047075 178278
5.08293.03	dist.radius plate 2.4; 9/3 holes; 28x55mm; broad; vas; right	 4 047075 178285
5.08293.04	dist.radius plate 2.4; 9/4 holes; 28x63mm; broad; vas; right	 4 047075 178292
5.08293.06	dist.radius plate 2.4; 9/6 holes; 28x80mm; broad; vas; right	 4 047075 178308
5.08293.08	dist.radius plate 2.4; 9/8 holes; 28x97mm; broad; vas; right	 4 047075 178315
5.08293.10	dist.radius plate 2.4; 9/10 holes; 28x114mm; broad; vas; right	 4 047075 178322
5.08293.12	dist.radius plate 2.4; 9/12 holes; 28x131mm; broad; vas; right	 4 047075 178339

Set Distal Radius Plate 2.4 vas

variable angle-stable; for screws Ø 2.4 mm; Titanium; Set no. 19.117.00



Item no. 5.08173.06

Item no. 5.08193.06



Item no. 5.08273.06

Item no. 5.08293.06



Set no. 19.117.00  Six lobe

Item no.	Item description	Quant.
Implants – plates		
Variable angle-stable distal radius plates 2.4; Titanium		
5.08173.03	dist.radius plate 2.4; 7/3 holes; 23x55mm; narrow; vas; left	1
5.08173.04	dist.radius plate 2.4; 7/4 holes; 23x63mm; narrow; vas; left	1
5.08273.03	dist.radius plate 2.4; 7/3 holes; 23x55mm; narrow; vas; right	1
5.08273.04	dist.radius plate 2.4; 7/4 holes; 23x63mm; narrow; vas; right	1

5.08193.03	dist.radius plate 2.4; 9/3 holes; 28x55mm; broad; vas; left	1
5.08193.04	dist.radius plate 2.4; 9/4 holes; 28x63mm; broad; vas; left	1
5.08293.03	dist.radius plate 2.4; 9/3 holes; 28x55mm; broad; vas; right	1
5.08293.04	dist.radius plate 2.4; 9/4 holes; 28x63mm; broad; vas; right	1

Instruments		
2.904.33	drill bit for quick coupling, Ø1.8x105, spiral length 30, double spiral	1
2.953.24	gauge w. clasp for screws Ø2.4, measuring range 60	1
2.9775.24	drill guide; Ø2.4 double cone; angle-stable	1
2.93886.08	screwdriver hexalobe size 8; PPSU-handle; L 180 mm	1
2.9419.08	screwdriver inset for hexalobe 08 OPTIONAL	0
10.500.24	drill guide with handle for standard screwing 2.4, length 45	1

Wires		
6.031.15	Kirschner wire with trocar point and round end, Ø1.5x150, st.st.	5

Item no.	Item description	Quant.
Implants – screws		
Cortical screw Ø 2.4 mm full thread; self tapping; Titanium  Six lobe		
3.0224.12	Length 12 mm	5
3.0224.14	Length 14 mm	5
3.0224.16	Length 16 mm	5
3.0224.18	Length 18 mm	5
3.0224.20	Length 20 mm	5

Angle-stable Cortical screw Ø 2.4 mm; full thread; self tapping; Titanium  Six lobe		
3.0124.12	Length 12 mm	5
3.0124.14	Length 14 mm	5
3.0124.16	Length 16 mm	5
3.0124.18	Length 18 mm	5
3.0124.20	Length 20 mm	5
3.0124.22	Length 22 mm	5
3.0124.24	Length 24 mm	5
3.0124.26	Length 26 mm	5
3.0124.28	Length 28 mm	5

Angle-stable Pins Ø 1.8 mm; Titanium  Six lobe		
3.0324.16	Length 16 mm	3
3.0324.18	Length 18 mm	3
3.0324.20	Length 20 mm	3
3.0324.22	Length 22 mm	3
3.0324.24	Length 24 mm	3
3.0324.26	Length 26 mm	3
3.0324.28	Length 28 mm	3

Set Distal Radius Plate 2.4 vas

variable angle-stable; for screws \varnothing 2.4 mm; Titanium; Set no. 19.117.00

Container		
19.118.00	perforated autoclavable container w.inset f.instr./impl. Radius-Set 2.4	1

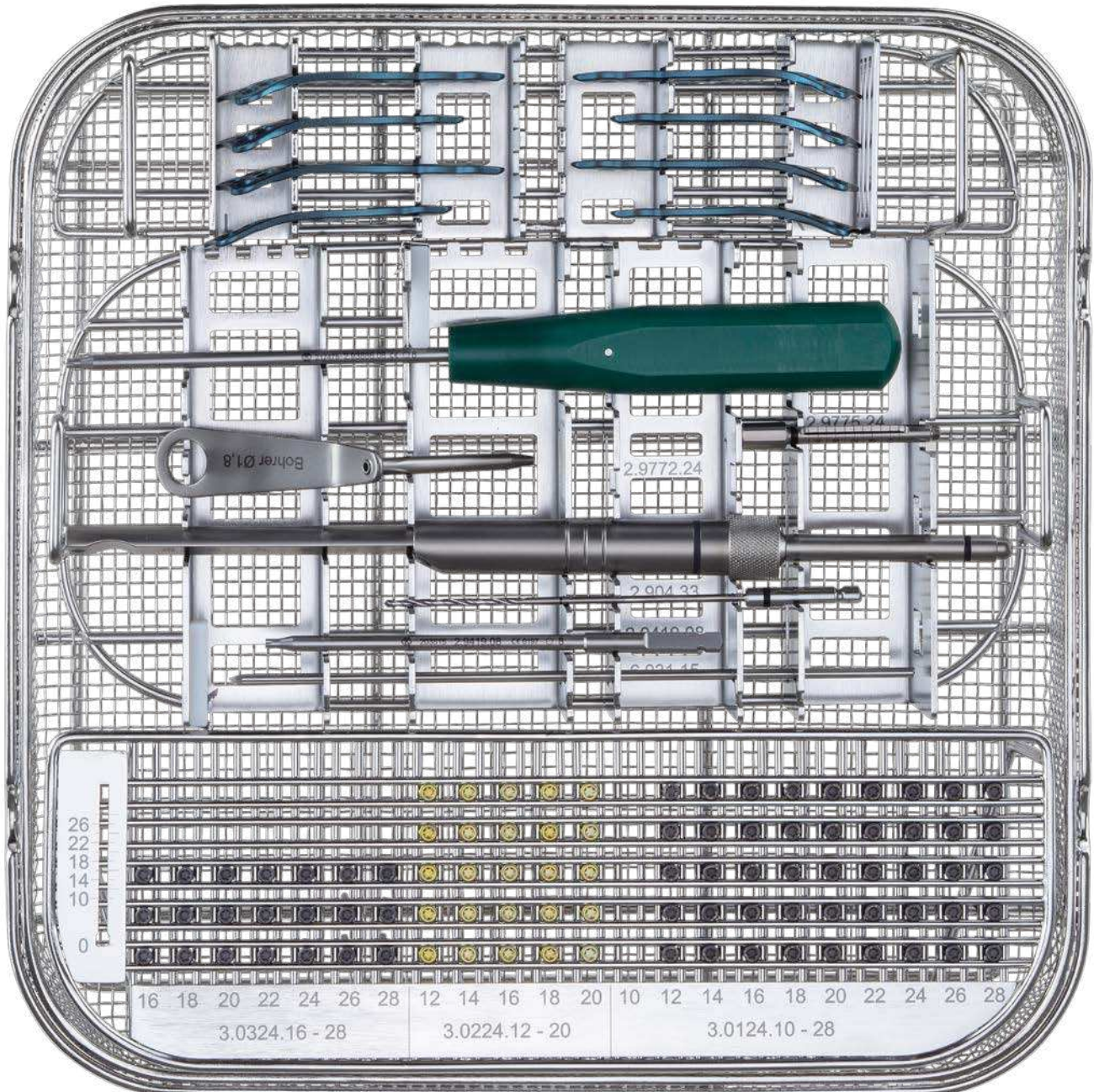

Set no. 19.117.00  Six lobe



Königsee Implantate GmbH
OT Aschau | Am Sand 4
07426 Allendorf | Germany

Fon +49 36738 498-560
Fax +49 36738 498-569

Mail export@koenigsee-implantate.de

For further information please visit:
www.koenigsee-implantate.com

AnSp | Edition 03 | 2020-02
All pictured products are CE compliant.

Angle-stable Distal Radius Plates 2.7

for Screws Ø 2.7 mm; Titanium



Item no. 5.9822.53



Item no. 5.9832.53



Item no. 5.9842.73



Item no. 5.9852.73

Item no.	Item description
----------	------------------

Angle-stable distal radius plates - head width 23 mm

5.9822.52	Distal radius plate with conical thread Ø 2.7 mm; 5/ 2 hole; 43 x 10 mm; right; narrow; titanium
5.9822.53	Distal radius plate with conical thread Ø 2.7 mm; 5/ 3 hole; 51 x 10 mm; right; narrow; titanium
5.9822.54	Distal radius plate with conical thread Ø 2.7 mm; 5/ 4 hole; 60 x 10 mm; right; narrow; titanium
5.9822.56	Distal radius plate with conical thread Ø 2.7 mm; 5/ 6 hole; 77 x 10 mm; right; narrow; titanium
5.9822.58	Distal radius plate with conical thread Ø 2.7 mm; 5/ 8 hole; 94 x 10 mm; right; narrow; titanium
5.9822.510	Distal radius plate with conical thread Ø 2.7 mm; 5/10 hole; 111 x 10 mm; right; narrow; titanium
5.9822.513	Distal radius plate with conical thread Ø 2.7 mm; 5/13 hole; 136 x 10 mm; right; narrow; titanium
5.9832.52	Distal radius plate with conical thread Ø 2.7 mm; 5/ 2 hole; 43 x 10 mm; left; narrow; titanium
5.9832.53	Distal radius plate with conical thread Ø 2.7 mm; 5/ 3 hole; 51 x 10 mm; left; narrow; titanium
5.9832.54	Distal radius plate with conical thread Ø 2.7 mm; 5/ 4 hole; 60 x 10 mm; left; narrow; titanium
5.9832.56	Distal radius plate with conical thread Ø 2.7 mm; 5/ 6 hole; 77 x 10 mm; left; narrow; titanium
5.9832.58	Distal radius plate with conical thread Ø 2.7 mm; 5/ 8 hole; 94 x 10 mm; left; narrow; titanium
5.9832.510	Distal radius plate with conical thread Ø 2.7 mm; 5/10 hole; 111 x 10 mm; left; narrow; titanium
5.9832.513	Distal radius plate with conical thread Ø 2.7 mm; 5/13 hole; 136 x 10 mm; left; narrow; titanium

Angle-stable distal radius plates - head width 27 mm

5.9842.72	Distal radius plate with conical thread Ø 2.7 mm; 7/ 2 hole; 43 x 10 mm; right; broad; titanium
5.9842.73	Distal radius plate with conical thread Ø 2.7 mm; 7/ 3 hole; 51 x 10 mm; right; broad; titanium
5.9842.74	Distal radius plate with conical thread Ø 2.7 mm; 7/ 4 hole; 60 x 10 mm; right; broad; titanium
5.9842.76	Distal radius plate with conical thread Ø 2.7 mm; 7/ 6 hole; 77 x 10 mm; right; broad; titanium
5.9842.78	Distal radius plate with conical thread Ø 2.7 mm; 7/ 8 hole; 94 x 10 mm; right; broad; titanium
5.9842.710	Distal radius plate with conical thread Ø 2.7 mm; 7/10 hole; 111 x 10 mm; right; broad; titanium
5.9842.713	Distal radius plate with conical thread Ø 2.7 mm; 7/13 hole; 136 x 10 mm; right; broad; titanium
5.9852.72	Distal radius plate with conical thread Ø 2.7 mm; 7/ 2 hole; 43 x 10 mm; left; broad; titanium
5.9852.73	Distal radius plate with conical thread Ø 2.7 mm; 7/ 3 hole; 51 x 10 mm; left; broad; titanium
5.9852.74	Distal radius plate with conical thread Ø 2.7 mm; 7/ 4 hole; 60 x 10 mm; left; broad; titanium
5.9852.76	Distal radius plate with conical thread Ø 2.7 mm; 7/ 6 hole; 77 x 10 mm; left; broad; titanium
5.9852.78	Distal radius plate with conical thread Ø 2.7 mm; 7/ 8 hole; 94 x 10 mm; left; broad; titanium
5.9852.710	Distal radius plate with conical thread Ø 2.7 mm; 7/10 hole; 111 x 10 mm; left; broad; titanium
5.9852.713	Distal radius plate with conical thread Ø 2.7 mm; 7/13 hole; 136 x 10 mm; left; broad; titanium

Set Angle-stable Distal Radius Plate 2.7

Titanium; Set no. 19.116.00



Item no. 5.9822.53



Item no. 5.9832.53



Item no. 5.9842.73



Item no. 5.9852.73



Set no. 19.116.00 Internal hexagon

Item no.	Item description	Quant.
Implants - plates		
Angle-stable distal radius plate 2.7; narrow; titanium		
5.9822.53	5 head holes; 3 shaft holes 51 mm x 10 mm; right	1
5.9822.54	5 head holes; 4 shaft holes 60 mm x 10 mm; right	1
5.9832.53	5 head holes; 3 shaft holes 51 mm x 10 mm; left	1
5.9832.54	5 head holes; 4 shaft holes 60 mm x 10 mm; left	1

Angle-stable distal radius plate 2.7; broad; titanium		
5.9842.73	7 head holes; 3 shaft holes 51 mm x 10 mm; right	1
5.9842.74	7 head holes; 4 shaft holes 60 mm x 10 mm; right	1
5.9852.73	7 head holes; 3 shaft holes 51 mm x 10 mm; left	1
5.9852.74	7 head holes; 4 shaft holes 60 mm x 10 mm; left	1

Instruments		
2.904.03	drill bit for quick coupling; Ø 2.0 mm x 105 mm; spiral length 30 mm; double spiral	1
2.9406.25	hex screwdriver with handle for screws Ø 2.7 mm - Ø 4.0 mm; AF2.5; conical; PPSU	1
2.953.65	gauge with clasp for screws Ø 2.7 mm; measuring range 60 mm	1
2.954.01	screw forceps; self holding	1
2.977.19	drill guide with handle for variable angle stable screwing 2.7; length 42 mm	1
2.977.11/3	drill guide for angle stable screwing 2.7; length 44 mm; single thread with knurl	2

Item no.	Item description	Quant.
Implants - screws		
Cortical screw with conical head thread; Ø 2.7 mm; fully threaded; self tapping; titanium		
3.125.12	length 12 mm	5
3.125.14	length 14 mm	5
3.125.16	length 16 mm	5
3.125.18	length 18 mm	5
3.125.20	length 20 mm	5
3.125.22	length 22 mm	5
3.125.24	length 24 mm	5
3.125.26	length 26 mm	5
3.125.28	length 28 mm	5

Cortical screw; Ø 2.7 mm; fully threaded; self tapping; titanium		
3.120.12	length 12 mm	5
3.120.14	length 14 mm	5
3.120.16	length 16 mm	5
3.120.18	length 18 mm	5
3.120.20	length 20 mm	5

Wire		
6.031.16	Kirschner wire with trocar point and round end; Ø 1.6 mm x 150 mm; stainless steel	5

Container		
19.115.00	perforated autoclavable container with inset for instruments and implants radius-set 2.7	1

Set Angle-stable Distal Radius Plate 2.7

Titanium; Set no. 19.116.00

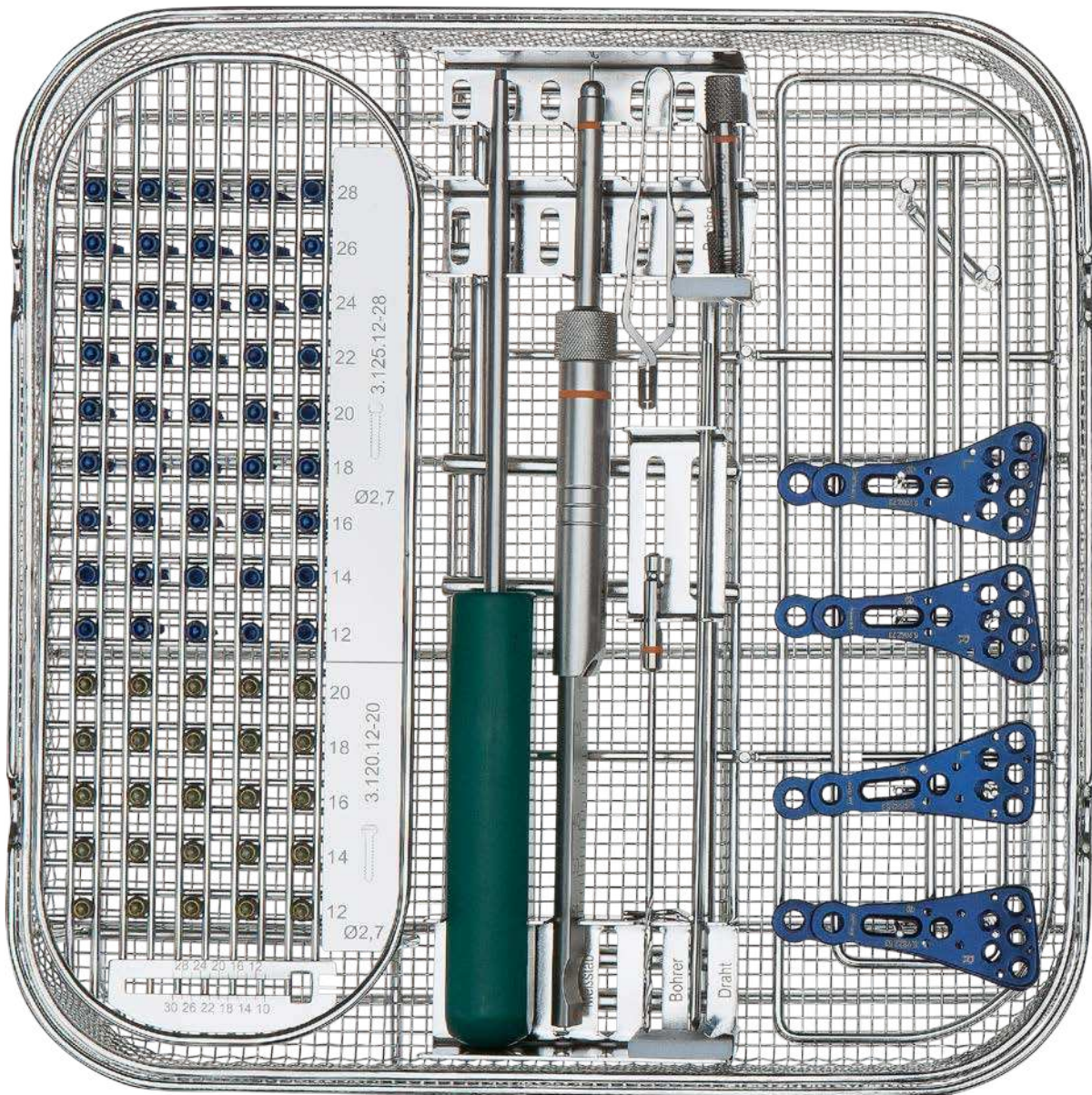

Set no. 19.116.00

Internal hexagon

Variable Angle-stable Distal Radius Plates 2.7

for Screws Ø 2.7 mm; Titanium



Item no. 5.9823.54



Item no. 5.9833.54



Item no. 5.9843.74



Item no. 5.9853.74

Item no. Item description

Variable angle-stable distal radius plates - head width 23 mm

5.9823.52	Distal radius plate with conical thread Ø 2.7 mm; 5/ 2 hole; 43 x 10 mm; right; narrow; vas; titanium
5.9823.53	Distal radius plate with conical thread Ø 2.7 mm; 5/ 3 hole; 51 x 10 mm; right; narrow; vas; titanium
5.9823.54	Distal radius plate with conical thread Ø 2.7 mm; 5/ 4 hole; 60 x 10 mm; right; narrow; vas; titanium
5.9823.56	Distal radius plate with conical thread Ø 2.7 mm; 5/ 6 hole; 77 x 10 mm; right; narrow; vas; titanium
5.9823.58	Distal radius plate with conical thread Ø 2.7 mm; 5/ 8 hole; 94 x 10 mm; right; narrow; vas; titanium
5.9823.510	Distal radius plate with conical thread Ø 2.7 mm; 5/10 hole; 111 x 10 mm; right; narrow; vas; titanium
5.9823.513	Distal radius plate with conical thread Ø 2.7 mm; 5/13 hole; 136 x 10 mm; right; narrow; vas; titanium
5.9833.52	Distal radius plate with conical thread Ø 2.7 mm; 5/ 2 hole; 43 x 10 mm; left; narrow; vas; titanium
5.9833.53	Distal radius plate with conical thread Ø 2.7 mm; 5/ 3 hole; 51 x 10 mm; left; narrow; vas; titanium
5.9833.54	Distal radius plate with conical thread Ø 2.7 mm; 5/ 4 hole; 60 x 10 mm; left; narrow; vas; titanium
5.9833.56	Distal radius plate with conical thread Ø 2.7 mm; 5/ 6 hole; 77 x 10 mm; left; narrow; vas; titanium
5.9833.58	Distal radius plate with conical thread Ø 2.7 mm; 5/ 8 hole; 94 x 10 mm; left; narrow; vas; titanium
5.9833.510	Distal radius plate with conical thread Ø 2.7 mm; 5/10 hole; 111 x 10 mm; left; narrow; vas; titanium
5.9833.513	Distal radius plate with conical thread Ø 2.7 mm; 5/13 hole; 136 x 10 mm; left; narrow; vas; titanium

Variable angle-stable distal radius plates - head width 27 mm

5.9843.72	Distal radius plate with conical thread Ø 2.7 mm; 7/ 2 hole; 43 x 10 mm; right; broad; vas; titanium
5.9843.73	Distal radius plate with conical thread Ø 2.7 mm; 7/ 3 hole; 51 x 10 mm; right; broad; vas; titanium
5.9843.74	Distal radius plate with conical thread Ø 2.7 mm; 7/ 4 hole; 60 x 10 mm; right; broad; vas; titanium
5.9843.76	Distal radius plate with conical thread Ø 2.7 mm; 7/ 6 hole; 77 x 10 mm; right; broad; vas; titanium
5.9843.78	Distal radius plate with conical thread Ø 2.7 mm; 7/ 8 hole; 94 x 10 mm; right; broad; vas; titanium
5.9843.710	Distal radius plate with conical thread Ø 2.7 mm; 7/10 hole; 111 x 10 mm; right; broad; vas; titanium
5.9843.713	Distal radius plate with conical thread Ø 2.7 mm; 7/13 hole; 136 x 10 mm; right; broad; vas; titanium
5.9853.72	Distal radius plate with conical thread Ø 2.7 mm; 7/ 2 hole; 43 x 10 mm; left; broad; vas; titanium
5.9853.73	Distal radius plate with conical thread Ø 2.7 mm; 7/ 3 hole; 51 x 10 mm; left; broad; vas; titanium
5.9853.74	Distal radius plate with conical thread Ø 2.7 mm; 7/ 4 hole; 60 x 10 mm; left; broad; vas; titanium
5.9853.76	Distal radius plate with conical thread Ø 2.7 mm; 7/ 6 hole; 77 x 10 mm; left; broad; vas; titanium
5.9853.78	Distal radius plate with conical thread Ø 2.7 mm; 7/ 8 hole; 94 x 10 mm; left; broad; vas; titanium
5.9853.710	Distal radius plate with conical thread Ø 2.7 mm; 7/10 hole; 111 x 10 mm; left; broad; vas; titanium
5.9853.713	Distal radius plate with conical thread Ø 2.7 mm; 7/13 hole; 136 x 10 mm; left; broad; vas; titanium

Guide Block for Radius Plates 2.7

for Screws \varnothing 2.7 mm; Polyetheretherketon (PEEK)



Item no. 10.180.05



Item no. 10.180.07

Item no.	Item description
----------	------------------

Guide block for variable angle-stable distal radius plates 2.7; width in the head 23 mm

10.180.05	guide block for distal radius plate 5.9823.xx; right
10.181.05	guide block for distal radius plate 5.9833.xx; left

Guide block for variable angle-stable distal radius plates 2.7; width in the head 27 mm

10.180.07	guide block for distal radius plate 5.9843.xx; right
10.181.07	guide block for distal radius plate 5.9853.xx; left

Set Variable Angle-stable Radius Plates 2.7

with Hexalobe Size 10; Titanium; Set no. 19.1161.00



Item no. 5.9823.53



Item no. 5.9833.53



Item no. 5.9843.73



Item no. 5.9853.73







Set no. 19.1161.00  six lobe

Item no.	Item description	Quant.
Implants - plates		
Distal radius plate 2.7; narrow; angle-stable variable; titanium		
5.9823.53	5 head holes; 3 shaft holes 51 mm x 10 mm; right	1
5.9823.54	5 head holes; 4 shaft holes 60 mm x 10 mm; right	1
5.9833.53	5 head holes; 3 shaft holes 51 mm x 10 mm; left	1
5.9833.54	5 head holes; 4 shaft holes 60 mm x 10 mm; left	1

Distal radius plate 2.7; broad; angle-stable variable; titanium		
5.9843.73	7 head holes; 3 shaft holes 51 mm x 10 mm; right	1
5.9843.74	7 head holes; 4 shaft holes 60 mm x 10 mm; right	1
5.9853.73	7 head holes; 3 shaft holes 51 mm x 10 mm; left	1
5.9853.74	7 head holes; 4 shaft holes 60 mm x 10 mm; left	1

Instruments		
2.904.03	drill bit for quick coupling; Ø 2.0 mm x 105 mm; spiral length 30 mm; double spiral	1
2.9386.10	screwdriver with handle for hexalobe size 10	1
2.953.65	gauge with clasp for screws Ø 2.7 mm; measuring range 60 mm	1
2.954.01	screw forceps; self holding	1
2.977.19	drill guide with handle for variable angle stable screwing 2.7; length 42 mm	1
2.977.11/3	drill guide for angle stable screwing 2.7; length 44 mm; single thread with knurl	2

Item no.	Item description	Quant.
Implants - screws		
Angle-stable cortical screw Ø 2.7 mm; self-tapping fully threaded; titanium		
		
	 six lobe	
3.1251.12	length 12 mm	5
3.1251.14	length 14 mm	5
3.1251.16	length 16 mm	5
3.1251.18	length 18 mm	5
3.1251.20	length 20 mm	5
3.1251.22	length 22 mm	5
3.1251.24	length 24 mm	5
3.1251.26	length 26 mm	5
3.1251.28	length 28 mm	5

Cortical screw Ø 2.7 mm flat head; fully threaded self-tapping; titanium		
		
	 six lobe	
3.1281.12	length 12 mm	5
3.1281.14	length 14 mm	5
3.1281.16	length 16 mm	5
3.1281.18	length 18 mm	5
3.1281.20	length 20 mm	5

Wire		
6.031.16	Kirschner wire with trocar point and round end; Ø 1.6 mm x 150 mm; stainless steel	5

Container		
19.1151.00	perforated autoclavable container with inset for instruments/implants radius plate 2.7 with hexalobe size 10	1

Set Variable Angle-stable Radius Plates 2.7

with Hexalobe Size 10; Titanium; Set no. 19.1161.00

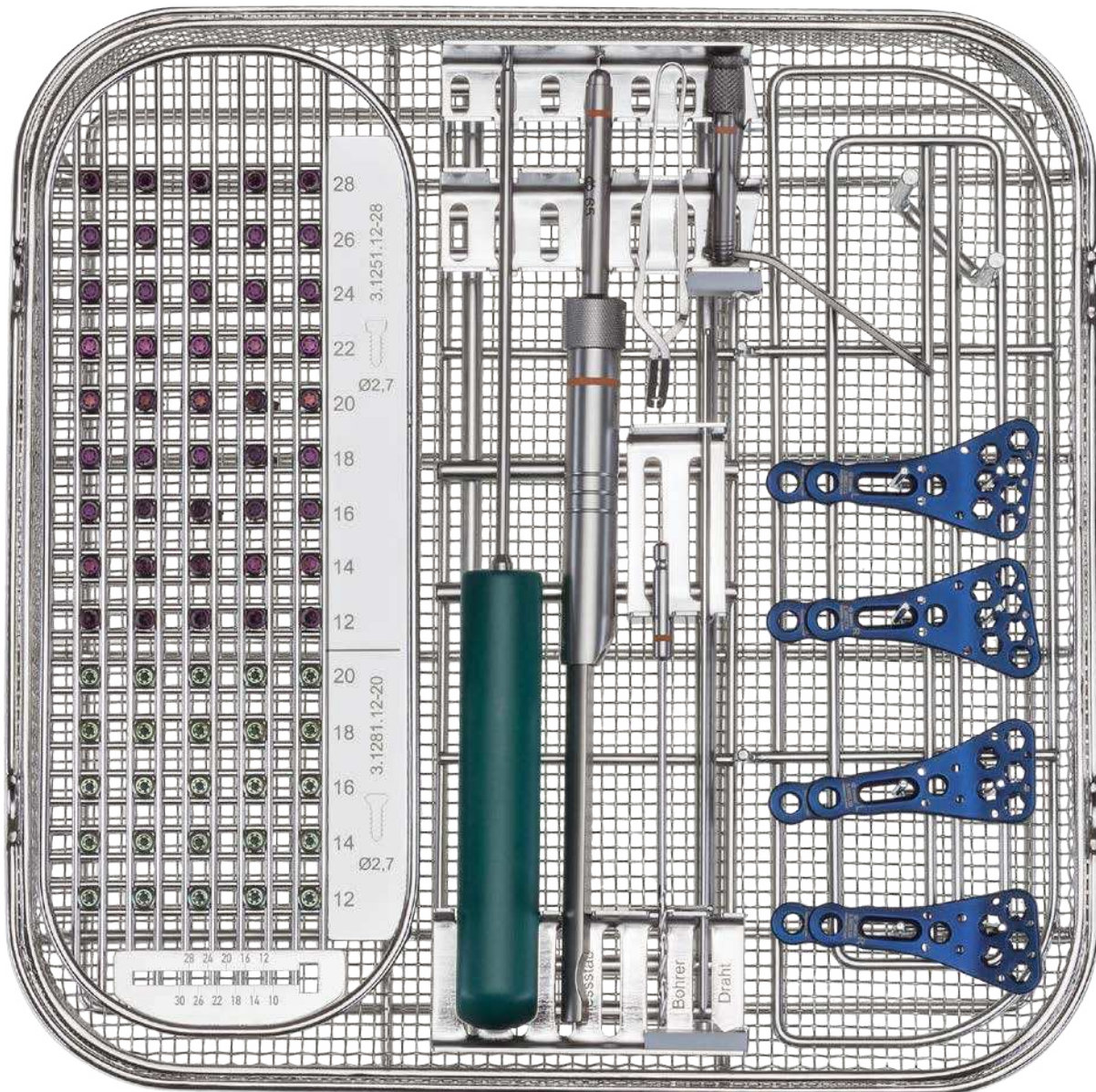

Set no. 19.1161.00

★ six lobe

Set Variable Angle-stable Distal Radius Plate 2.7

Titanium; Set no. 19.1163.00



Item no. 5.9823.53



Item no. 5.9833.53



Item no. 5.9843.73



Item no. 5.9853.73



Set no. 19.1163.00 Internal hexagon

Item no.	Item description	Quant.
Implants - plates		
Distal radius plate 2.7; narrow; angle-stable variable; titanium		
5.9823.53	5 head holes; 3 shaft holes 51 mm x 10 mm; right	1
5.9823.54	5 head holes; 4 shaft holes 60 mm x 10 mm; right	1
5.9833.53	5 head holes; 3 shaft holes 51 mm x 10 mm; left	1
5.9833.54	5 head holes; 4 shaft holes 60 mm x 10 mm; left	1

Distal radius plate 2.7; broad; angle-stable variable; titanium		
5.9843.73	7 head holes; 3 shaft holes 51 mm x 10 mm; right	1
5.9843.74	7 head holes; 4 shaft holes 60 mm x 10 mm; right	1
5.9853.73	7 head holes; 3 shaft holes 51 mm x 10 mm; left	1
5.9853.74	7 head holes; 4 shaft holes 60 mm x 10 mm; left	1

Instruments		
2.904.03	drill bit for quick coupling; Ø 2.0 mm x 105 mm; spiral length 30 mm; double spiral	1
2.9406.25	hex screwdriver with handle for screws Ø 2.7 - Ø 4.0 mm; AF2.5; conical; PPSU	1
2.953.65	gauge with clasp for screws Ø 2.7 mm; measuring range 60 mm	1
2.954.01	screw forceps; self holding	1
2.977.19	drill guide with handle for variable angle stable screwing 2.7; length 42 mm	1
2.977.11/3	drill guide for angle stable screwing 2.7; length 44 mm; single thread with knurl	2

Item no.	Item description	Quant.
Implants - screws		
Angle-stable cortical screw Ø 2.7 mm; self-tapping fully threaded; head 5.0 mm; titanium Internal hexagon		
3.125.12	length 12 mm	5
3.125.14	length 14 mm	5
3.125.16	length 16 mm	5
3.125.18	length 18 mm	5
3.125.20	length 20 mm	5
3.125.22	length 22 mm	5
3.125.24	length 24 mm	5
3.125.26	length 26 mm	5
3.125.28	length 28 mm	5

Cortical screw Ø 2.7 mm fully threaded self-tapping; titanium Internal hexagon		
3.120.12	length 12 mm	5
3.120.14	length 14 mm	5
3.120.16	length 16 mm	5
3.120.18	length 18 mm	5
3.120.20	length 20 mm	5

Wire		
6.031.16	Kirschner wire with trocar point and round end; Ø 1.6 mm x 150 mm; stainless steel	5

Container		
19.115.00	perforated autoclavable container with inset for instruments/implants radius plate 2.7	1

Set Variable Angle-stable Distal Radius Plate 2.7

Titanium; Set no. 19.1163.00

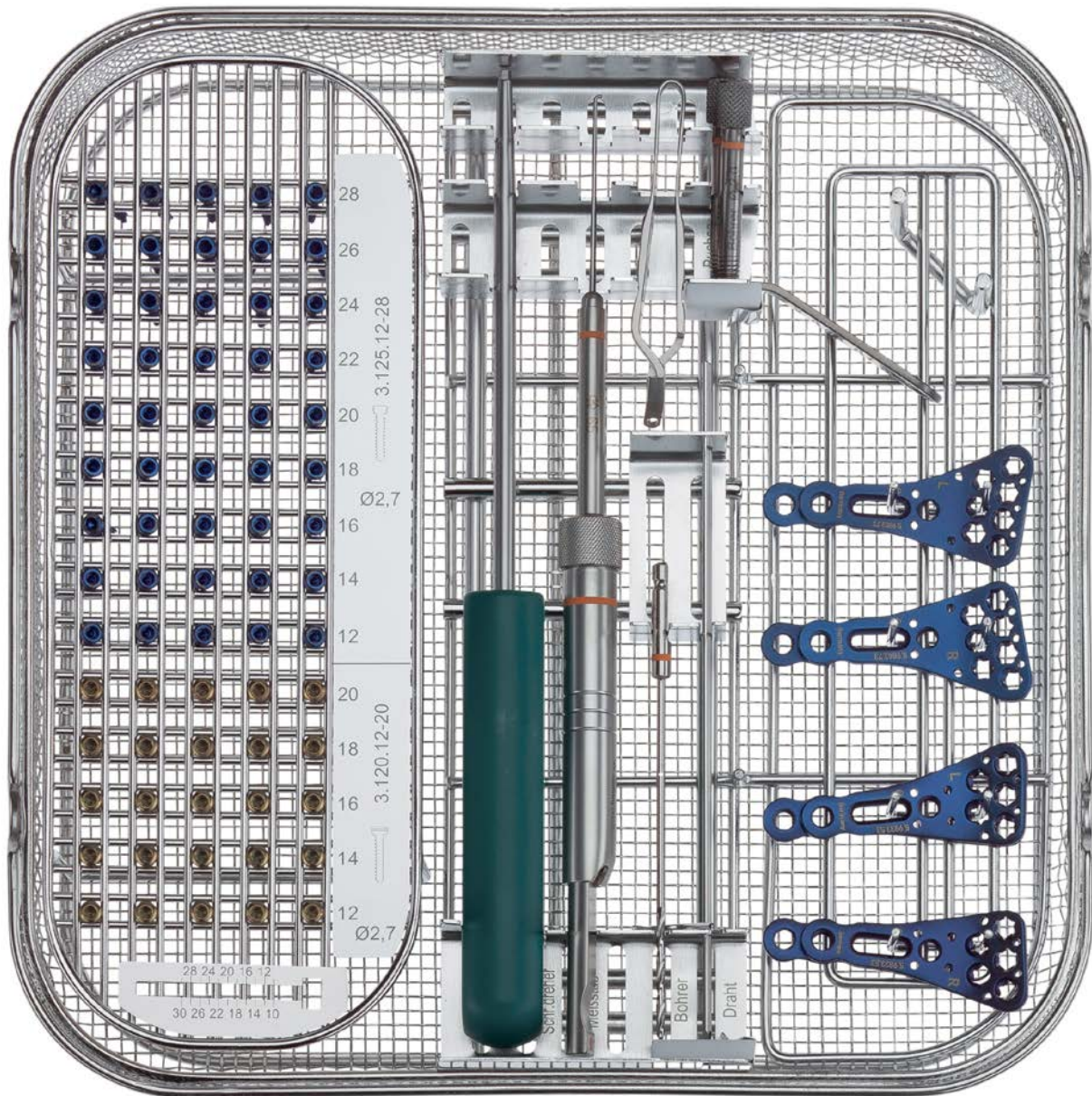

Set no. 19.1163.00

Internal hexagon

Distal radius plate 3.5 Twin

angle-stable; for screws \varnothing 3.5 mm; titanium



Item no. 5.876.53

Item no.	Item description	EAN
Distal radius plate 3.5 Twin as		
5.876.53	Dist. radius plate "Twin" 3.5; 5/3 holes; 51x10mm; R; thickness 3,0mm head/1,7mm shaft	 4047075010882
5.876.55	Dist. radius plate "Twin" 3.5; 5/5 holes; 68x10mm; R; thickness 3,0mm head/1,7mm shaft	 4047075011032
5.876.513	Dist. radius plate "Twin" 3.5; 5/13 holes; 136x10mm; R; thickness 3,0mm head/1,7mm shaft	 4047075090945
5.877.53	Dist. radius plate "Twin" 3.5; 5/3 holes; 51x10mm; L; thickness 3,0mm head/1,7mm shaft	 4047075011216
5.877.54	Dist. radius plate "Twin" 3.5; 5/4 holes; 59x10mm; L; thickness 3,0mm head/1,7mm shaft	 4047075011223
5.877.55	Dist. radius plate "Twin" 3.5; 5/5 holes; 68x10mm; L; thickness 3,0mm head/1,7mm shaft	 4047075011230

Distal radius plate 3.5

angle-stable; for screws Ø 3.5 mm; titanium



Item no. 5.876.34



Item no. 5.882.34

Item no.	Item description	EAN
----------	------------------	-----

Distal radius plate 3.5 Classic as

5.876.33	Dist. radius plate Classic 3.5; 3/3 holes; 51x10mm; R; thickness 3,0mm head/1,7mm shaft	
5.876.34	Dist. radius plate Classic 3.5; 3/4 holes; 59x10mm; R; thickness 3,0mm head/1,7mm shaft	
5.876.35	Dist. radius plate Classic 3.5; 3/5 holes; 68x10mm; R; thickness 3,0mm head/1,7mm shaft	
5.876.36	Dist. radius plate Classic 3.5; 3/6 holes; 76x10mm; R; thickness 3,0mm head/1,7mm shaft	
5.876.38	Dist. radius plate Classic 3.5; 3/8 holes; 93x10mm; R; thickness 3,0mm head/1,7mm shaft	
5.876.310	Dist. radius plate Classic 3.5; 3/10 holes; 110x10mm; R; thickness 3,0mm head/1,7mm shaft	
5.876.313	Dist. radius plate Classic 3.5; 3/13 holes; 136x10mm; R; thickness 3,0mm head/1,7mm shaft	
5.877.33	Dist. radius plate Classic 3.5; 3/3 holes; 51x10mm; L; thickness 3,0mm head/1,7mm shaft	
5.877.34	Dist. radius plate Classic 3.5; 3/4 holes; 59x10mm; L; thickness 3,0mm head/1,7mm shaft	
5.877.36	Dist. radius plate Classic 3.5; 3/6 holes; 76x10mm; L; thickness 3,0mm head/1,7mm shaft	
5.877.38	Dist. radius plate Classic 3.5; 3/8 holes; 93x10mm; L; thickness 3,0mm head/1,7mm shaft	
5.877.310	Dist. radius plate Classic 3.5; 3/10 holes; 110x10mm; L; thickness 3,0mm head/1,7mm shaft	
5.877.313	Dist. radius plate Classic 3.5; 3/13 holes; 136x10mm; L; thickness 3,0mm head/1,7mm shaft	

Distal radius plate 3.5 Minor as

5.882.33	Dist. radius plate Minor 3.5; 3/3 holes; 51x10mm; R; thickness 3,0mm head/1,5mm shaft	
5.882.34	Dist. radius plate Minor 3.5; 3/4 holes; 59x10mm; R; thickness 3,0mm head/1,5mm shaft	
5.882.36/2	Dist. radius plate Minor 3.5/3.5; 3/6 holes; 76x10mm; R; thickness 3,0mm head/2,0mm shaft	
5.882.38/2	Dist. radius plate Minor 3.5/3.5; 3/8 holes; 93x10mm; R; thickness 3,0mm head/2,0mm shaft	
5.883.33	Dist. radius plate Minor 3.5; 3/3 holes; 51x10mm; L; thickness 3,0mm head/1,5mm shaft	
5.883.34	Dist. radius plate Minor 3.5; 3/4 holes; 59x10mm; L; thickness 3,0mm head/1,5mm shaft	
5.883.36/2	Dist. radius plate Minor 3.5/3.5; 3/6 holes; 76x10mm; L; thickness 3,0mm head/2,0mm shaft	
5.883.38/3	Dist. radius plate Minor 3.5/3.5; 3/8 holes; 93x10mm; L; thickness 3,0mm head/3,0mm shaft	

Distal radius plate 3.5

angle-stable; for screws Ø 3.5 mm; titanium



Item no. 5.876.44

Item no.	Item description	EAN
Distal radius plate 3.5 Quadro as		
5.876.43	Dist. radius plate Quadro 3.5; 4/3 holes; 51x10mm; R; thickness 3,0mm head/1,7mm shaft	 4047075032198
5.876.43/2	Dist. radius plate Quadro 3.5; 4/3 holes; 51x10mm; R; thickness 3,0mm head/2,0mm shaft	 4047075057412
5.876.44	Dist. radius plate Quadro 3.5; 4/4 holes; 59x10mm; R; thickness 3,0mm head/1,7mm shaft	 4047075032204
5.876.44/2	Dist. radius plate Quadro 3.5; 4/4 holes; 59x10mm; R; thickness 3,0mm head/2,0mm shaft	 4047075057429
5.876.45/2	Dist. radius plate Quadro 3.5; 4/5 holes; 68x10mm; R; thickness 3,0mm head/2,0mm shaft	 4047075057887
5.876.46/2	Dist. radius plate Quadro 3.5; 4/6 holes; 76x10mm; R; thickness 3,0mm head/2,0mm shaft	 4047075111879
5.876.48/2	Dist. radius plate Quadro 3.5; 4/8 holes; 93x10mm; R; thickness 3,0mm head/2,0mm shaft	 4047075111886
5.876.48/3	Dist. radius plate Quadro 3.5; 4/8 holes; 93x10mm; R; thickness 3,0mm head/3,0mm shaft	 4047075056040
5.877.43	Dist. radius plate Quadro 3.5; 4/3 holes; 51x10mm; L; thickness 3,0mm head/1,7mm shaft	 4047075032167
5.877.44	Dist. radius plate Quadro 3.5; 4/4 holes; 59x10mm; L; thickness 3,0mm head/1,7mm shaft	 4047075032174
5.877.44/2	Dist. radius plate Quadro 3.5; 4/4 holes; 59x10mm; L; thickness 3,0mm head/2,0mm shaft	 4047075057498
5.877.45/2	Dist. radius plate Quadro 3.5; 4/5 holes; 68x10mm; L; thickness 3,0mm head/2,0mm shaft	 4047075057870
5.877.46/2	Dist. radius plate Quadro 3.5; 4/6 holes; 76x10mm; L; thickness 3,0mm head/2,0mm shaft	 4047075111893
5.877.48/2	Dist. radius plate Quadro 3.5; 4/8 holes; 93x10mm; L; thickness 3,0mm head/2,0mm shaft	 4047075111909
5.877.48/3	Dist. radius plate Quadro 3.5; 4/8 holes; 93x10mm; L; thickness 3,0mm head/3,0mm shaft	 4047075056057

Distal radius plate 3.5

angle-stable; for screws Ø 3.5 mm; titanium



Item no. 5.886.34

Item no.	Item description	EAN
----------	------------------	-----

Distal radius plate 3.5 Vario as

5.886.310/3	Dist. radius plate Vario 3.5/3.5; 3/10 holes; 110x10mm; R; thickness 3,0mm head/3,0mm shaft	 4047075111206
5.886.313/3	Dist. radius plate Vario 3.5/3.5; 3/13 holes; 136x10mm; R; thickness 3,0mm head/3,0mm shaft	 4047075111213
5.886.33	Dist. radius plate Vario 3.5/3.5; 3/3 holes; 51x10mm; R; thickness 3,0mm head/1,7mm shaft	 4047075011254
5.886.34	Dist. radius plate Vario 3.5/3.5; 3/4 holes; 59x10mm; R; thickness 3,0mm head/1,7mm shaft	 4047075011315
5.886.36/2	Dist. radius plate Vario 3.5/3.5; 3/6 holes; 76x10mm; R; thickness 3,0mm head/2,0mm shaft	 4047075111183
5.886.38/2	Dist. radius plate Vario 3.5/3.5; 3/8 holes; 93x10mm; R; thickness 3,0mm head/2,0mm shaft	 4047075111190
5.886.38/3	Dist. radius plate Vario 3.5/3.5; 3/8 holes; 93x10mm; R; thickness 3,0mm head/3,0mm shaft	 4047075122240
5.887.310/3	Dist. radius plate Vario 3.5/3.5; 3/10 holes; 110x10mm; L; thickness 3,0mm head/3,0mm shaft	 4047075111244
5.887.313/3	Dist. radius plate Vario 3.5/3.5; 3/13 holes; 136x10mm; L; thickness 3,0mm head/3,0mm shaft	 4047075111251
5.887.33	Dist. radius plate Vario 3.5/3.5; 3/3 holes; 51x10mm; L; thickness 3,0mm head/1,7mm shaft	 4047075011322
5.887.34	Dist. radius plate Vario 3.5/3.5; 3/4 holes; 59x10mm; L; thickness 3,0mm head/1,7mm shaft	 4047075011339
5.887.36/2	Dist. radius plate Vario 3.5/3.5; 3/6 holes; 76x10mm; L; thickness 3,0mm head/2,0mm shaft	 4047075111220
5.887.38/2	Dist. radius plate Vario 3.5/3.5; 3/8 holes; 93x10mm; L; thickness 3,0mm head/2,0mm shaft	 4047075111237
5.887.38/3	Dist. radius plate Vario 3.5/3.5; 3/8 holes; 93x10mm; L; thickness 3,0mm head/1,7mm shaft	 4047075122257

Radius

Set Distal Radius plates 3.5 as

for screws Ø 3.5 mm; titanium; Set no. 19.112.00



Item no. 5.876.33 Classic



Item no. 5.886.33 Vario



Item no. 5.876.43 Quadro



Item no. 5.882.33 Minor



Set no. 19.112.00 Internal hexagon

Item no.	Item description	Quant.
Implants – plates		
Distal Radius plate 3.5 Classic as, titanium		
5.876.33	3/3 holes; 51x10mm; R; thickness 3,0mm head/1,7mm shaft	1
5.876.34	3/4 holes; 59x10mm; R; thickness 3,0mm head/1,7mm shaft	1
5.877.33	3/3 holes; 51x10mm; L; thickness 3,0mm head/1,7mm shaft	1
5.877.34	3/4 holes; 59x10mm; L; thickness 3,0mm head/1,7mm shaft	1

The standard equipment of the set is made with four different **Classic 3.5 plates**.

Optionally, these can be replaced by four different **Vario 3.5 plates**, **Quadro 3.5 plates** or **Minor 3.5 plates**.

Item no.	Item description	Quant.
Implants – plates		
Distal Radius plate 3.5 Vario as, titanium		
5.886.33	3/3 holes; 51x10mm; R; thickness 3,0mm head/1,7mm shaft	0
5.886.34	3/4 holes; 59x10mm; R; thickness 3,0mm head/1,7mm shaft	0
5.887.33	3/3 holes; 51x10mm; L; thickness 3,0mm head/1,7mm shaft	0
5.887.34	3/4 holes; 59x10mm; L; thickness 3,0mm head/1,7mm shaft	0

Implants – plates		
Distal Radius plate 3.5 Quadro as, titanium		
5.876.43	4/3 holes; 51x10mm; R; thickness 3,0mm head/1,7mm shaft	0
5.876.44	4/4 holes; 59x10mm; R; thickness 3,0mm head/1,7mm shaft	0
5.877.43	4/3 holes; 51x10mm; L; thickness 3,0mm head/1,7mm shaft	0
5.877.44	4/4 holes; 59x10mm; L; thickness 3,0mm head/1,7mm shaft	0

Implants – plates		
Distal Radius plate 3.5 Minor as, titanium		
5.882.33	3/3 holes; 51x10mm; R; thickness 3,0mm head/1,5mm shaft	0
5.882.34	4/4 holes; 59x10mm; R; thickness 3,0mm head/1,7mm shaft	0
5.883.33	4/3 holes; 51x10mm; L; thickness 3,0mm head/1,7mm shaft	0
5.883.34	4/4 holes; 59x10mm; L; thickness 3,0mm head/1,7mm shaft	0



Königsee Implantate GmbH
OT Aschau | Am Sand 4
07426 Allendorf | Germany

Fon +49 36738 498-560
Fax +49 36738 498-569

Mail export@koenigsee-implantate.de

For further information please visit:
www.koenigsee-implantate.com

HeBo | Edition 02 | 2019-08
All pictured products are CE compliant.

Set Distal Radius plates 3.5 as

for screws Ø 3.5 mm; titanium; Set no. 19.112.00



Item no. 3.132.XX



Item no. 3.133.XX



Set no. 19.112.00 Internal hexagon

Item no.	Item description	Quant.
Implants – screws		
Cortical screw Ø 3.5 mm; fully threaded; self tapping; titanium		
3.132.14	length 14 mm	5
3.132.16	length 16 mm	5
3.132.18	length 18 mm	5
3.132.20	length 20 mm	5
3.132.22	length 22 mm	5
3.132.24	length 24 mm	5

Item no.	Item description	Quant.
Implants – screws		
Angle-stable Cortical screw Ø 3.5 mm; fully threaded; self tapping; titanium		
3.133.16	length 16 mm	3
3.133.18	length 18 mm	3
3.133.20	length 20 mm	3
3.133.22	length 22 mm	3
3.133.24	length 24 mm	3
3.133.26	length 26 mm	3
3.133.28	length 28 mm	3
3.133.30	length 30 mm	3

Item no.	Item description	Quant.
Instruments		
10.500.27A	drill guide with handle for small fragment, handle length 55mm	1
2.904.05	drill bit for quick coupling, Ø2.5x105 mm, spiral length 50mm, double spiral	1
2.9406.25	hex screwdriver with handle for screws Ø2.7 - Ø4.0 mm, AF 2.5 mm, conical	1
2.953.60	gauge with clasp for screws Ø3.5 mm, Ø4.0 mm, measuring range 60mm	1
2.954.01	screw forceps, self holding	1
2.977.01	drill guide for angle stable screwing, length 45mm, small fragment	2

Item no.	Item description	Quant.
Wires		
6.031.18	Kirschner wire with trocar point and round end, Ø1.8x150 mm, st.st.	5

Item no.	Item description	Quant.
Container		
19.113.00	perforated autoclavable container with inset for instruments/implants radius-set	1

Set Distal Radius plates 3.5 as

for screws \varnothing 3.5 mm; titanium; Set no. 19.112.00

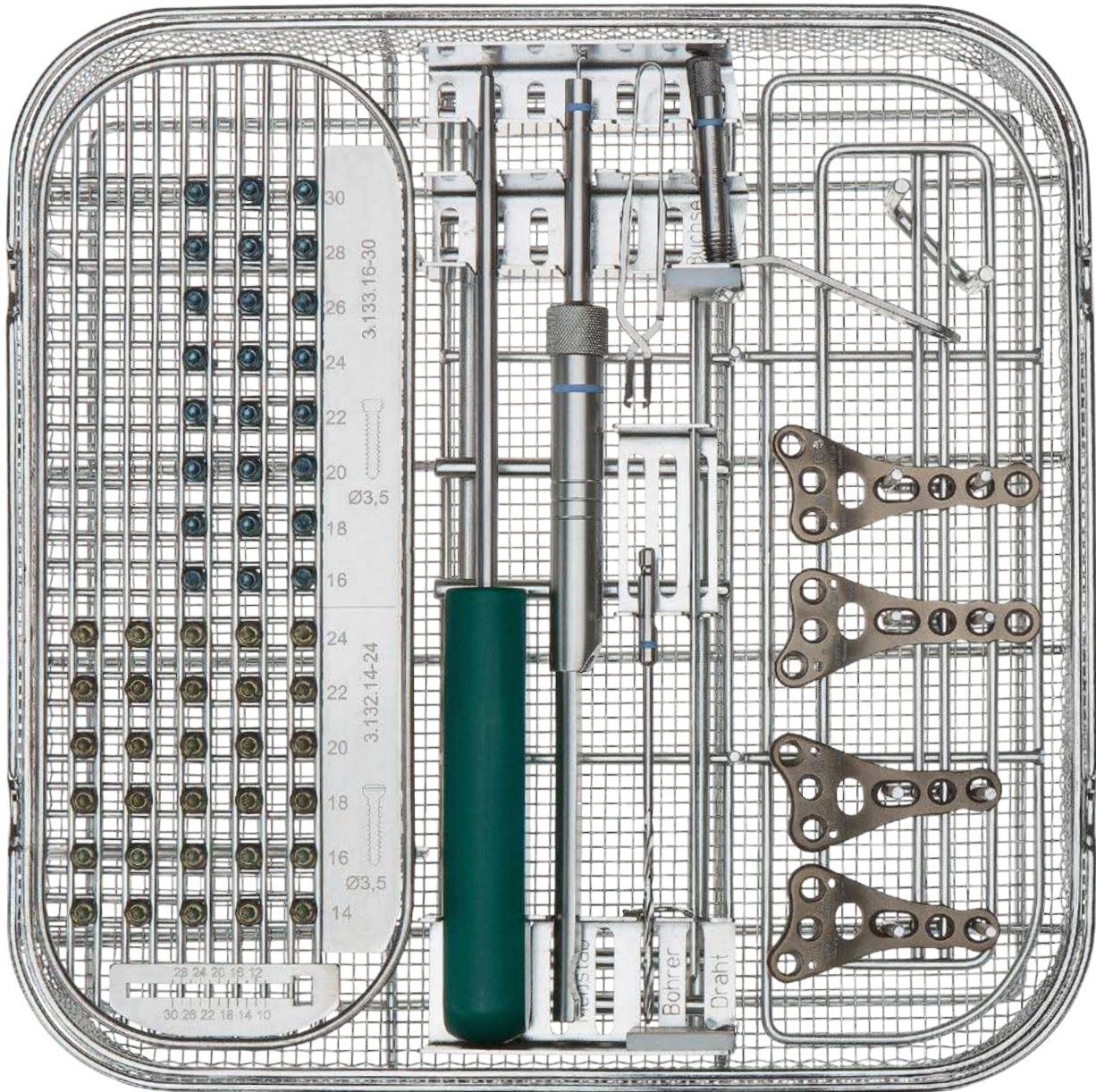

Set no. 19.112.00

Radius

Distal radius plate 3.5 vas

variable angle-stable; for screws Ø 3.5 mm; titanium







Item no. 5.8763.34



Item no. 5.8823.34

Item no.	Item description	EAN
----------	------------------	-----

Distal radius plate 3.5 Classic vas

5.8763.33	Distal radius plate Classic 3.5; 3/3 holes; 51x10mm; R; thickness 3,0mm head/2,0mm shaft	 4047075111428
5.8763.34	Distal radius plate Classic 3.5; 3/4 holes; 59x10mm; R; thickness 3,0mm head/2,0mm shaft	 4047075111435
5.8763.36	Distal radius plate Classic 3.5; 3/6 holes; 76x10mm; R; thickness 3,0mm head/2,0mm shaft	 4047075121106
5.8763.38	Distal radius plate Classic 3.5; 3/8 holes; 93x10mm; R; thickness 3,0mm head/3,0mm shaft	 4047075121113
5.8763.310	Distal radius plate Classic 3.5; 3/10 holes; 110x10mm; R; thickness 3,0mm head/3,0mm shaft	 4047075121083
5.8763.313	Distal radius plate Classic 3.5; 3/13 holes; 136x10mm; R; thickness 3,0mm head/3,0mm shaft	 4047075121090
5.8773.33	Distal radius plate Classic 3.5; 3/3 holes; 51x10mm; R; thickness 3,0mm head/2,0mm shaft	 4047075111442
5.8773.34	Distal radius plate Classic 3.5; 3/4 holes; 59x10mm; R; thickness 3,0mm head/2,0mm shaft	 4047075111459
5.8773.36	Distal radius plate Classic 3.5; 3/6 holes; 76x10mm; L; thickness 3,0mm head/2,0mm shaft	 4047075121144
5.8773.38	Distal radius plate Classic 3.5; 3/8 holes; 93x10mm; L; thickness 3,0mm head/3,0mm shaft	 4047075121151
5.8773.310	Distal radius plate Classic 3.5; 3/10 holes; 110x10mm; L; thickness 3,0mm head/3,0mm shaft	 4047075121120
5.8773.313	Distal radius plate Classic 3.5; 3/13 holes; 136x10mm; L; thickness 3,0mm head/3,0mm shaft	 4047075121137

Distal radius plate 3.5 Minor vas

5.8823.33	Distal radius plate Minor 3.5; 3/3 holes; 51x10mm; R; thickness 3,0mm head/2,0mm shaft	 4047075116492
5.8823.34	Distal radius plate Minor 3.5; 3/4 holes; 59x10mm; R; thickness 3,0mm head/2,0mm shaft	 4047075116508
5.8823.36	Distal radius plate Minor 3.5; 3/6 holes; 76x10mm; R; thickness 3,0mm head/2,0mm shaft	 4047075120338
5.8823.38	Distal radius plate Minor 3.5; 3/8 holes; 93x10mm; R; thickness 3,0mm head/3,0mm shaft	 4047075120345
5.8823.310	Distal radius plate Minor 3.5; 3/10 holes; 110x10mm; R; thickness 3,0mm head/3,0mm shaft	 4047075120314
5.8823.313	Distal radius plate Minor 3.5; 3/13 holes; 136x10mm; R; thickness 3,0mm head/3,0mm shaft	 4047075120321
5.8833.33	Distal radius plate Minor 3.5; 3/3 holes; 51x10mm; L; thickness 3,0mm head/2,0mm shaft	 4047075116515
5.8833.34	Distal radius plate Minor 3.5; 3/4 holes; 59x10mm; L; thickness 3,0mm head/2,0mm shaft	 4047075116522
5.8833.36	Distal radius plate Minor 3.5; 3/6 holes; 76x10mm; L; thickness 3,0mm head/2,0mm shaft	 4047075120376
5.8833.38	Distal radius plate Minor 3.5; 3/8 holes; 93x10mm; L; thickness 3,0mm head/3,0mm shaft	 4047075120383
5.8833.310	Distal radius plate Minor 3.5; 3/10 holes; 110x10mm; L; thickness 3,0mm head/3,0mm shaft	 4047075120352
5.8833.313	Distal radius plate Minor 3.5; 3/13 holes; 136x10mm; L; thickness 3,0mm head/3,0mm shaft	 4047075120369

Set Distal Radius plates 3.5 vas

for screws Ø 3.5 mm; titanium; Set no. 19.1123.00



Item no. 5.8763.33 Classic



Item no. 5.8823.33 Minor



Set no. 19.1123.00 Internal hexagon

Choose 4 pieces in total between ...

Item no.	Item description	Quant.
Implants – plates		
Distal Radius plate 3.5 Classic vas, titanium		
5.8763.33	3/3 holes; 51x10mm; vas; R; titanium; thickness 3,0mm head/2,0mm shaft	1
5.8763.34	3/4 holes; 59x10mm; vas; R; titanium; thickness 3,0mm head/2,0mm shaft	1
5.8773.33	3/3 holes; 51x10mm; vas; L; titanium; thickness 3,0mm head/2,0mm shaft	1
5.8773.34	3/4 holes; 59x10mm; vas; L; titanium; thickness 3,0mm head/2,0mm shaft	1

and/or:

Item no.	Item description	Quant.
Implants – plates		
Distal Radius plate 3.5 Minor vas, titanium		
5.8823.33	3/3 holes; 51 x 10mm; vas; R; titanium; thickness 3,0mm head/2,0mm shaft	1
5.8823.34	3/4 holes; 59 x 10mm; vas; R; titanium; thickness 3,0mm head/2,0mm shaft	1
5.8833.33	3/3 holes; 51 x 10mm; vas; L; titanium; thickness 3,0mm head/2,0mm shaft	1
5.8833.34	3/4 holes; 59 x 10mm; vas; L; titanium; thickness 3,0mm head/2,0mm shaft	1

Item no.	Item description	Quant.
Implants – screws		
Cortical screw Ø 3.5 mm; fully threaded; self tapping; titanium		
3.132.14	length 14 mm	5
3.132.16	length 16 mm	5
3.132.18	length 18 mm	5
3.132.20	length 20 mm	5
3.132.22	length 22 mm	5
3.132.24	length 24 mm	5

Item no.	Item description	Quant.
Implants – screws		
Angle-stable Cortical screw Ø 3.5 mm; fully threaded; self tapping; titanium		
3.133.16	length 16 mm	3
3.133.18	length 18 mm	3
3.133.20	length 20 mm	3
3.133.22	length 22 mm	3
3.133.24	length 24 mm	3
3.133.26	length 26 mm	3
3.133.28	length 28 mm	3
3.133.30	length 30 mm	3

Set Distal Radius plates 3.5 vas

for screws Ø 3.5 mm; titanium; Set no. 19.1123.00



Item no. 3.132.XX



Item no. 3.133.XX



Set no. 19.1123.00  Internal hexagon

Item no.	Item description	Quant.
Instruments		
10.500.27A	drill guide with handle for small fragment, handle length 55mm	1
2.904.05	drill bit for quick coupling, Ø2.5x105 mm, spiral length 50mm, double spiral	1
2.9406.25	hex screwdriver with handle for screws Ø2.7mm - Ø4.0 mm, AF 2.5 mm, conical	1
2.953.60	gauge with clasp for screws Ø3.5 mm, Ø4.0 mm, measuring range 60mm	1
2.954.01	screw forceps, self holding	1
2.977.01	drill guide for angle stable screwing, length 45mm, small fragment	1
2.977.08	drill guide w.handle for variable angle stable screwing, small fragment, length 45 mm	1

Item no.	Item description	Quant.
Wires		
6.031.18	Kirschner wire with trocar point and round end, Ø1.8x150 mm, st.st.	5

Container		
19.113.00	perforated autoclavable container with inset for instruments/implants radius-set	1

Set Distal Radius plates 3.5 vas

for screws \varnothing 3.5 mm; titanium; Set no. 19.1123.00

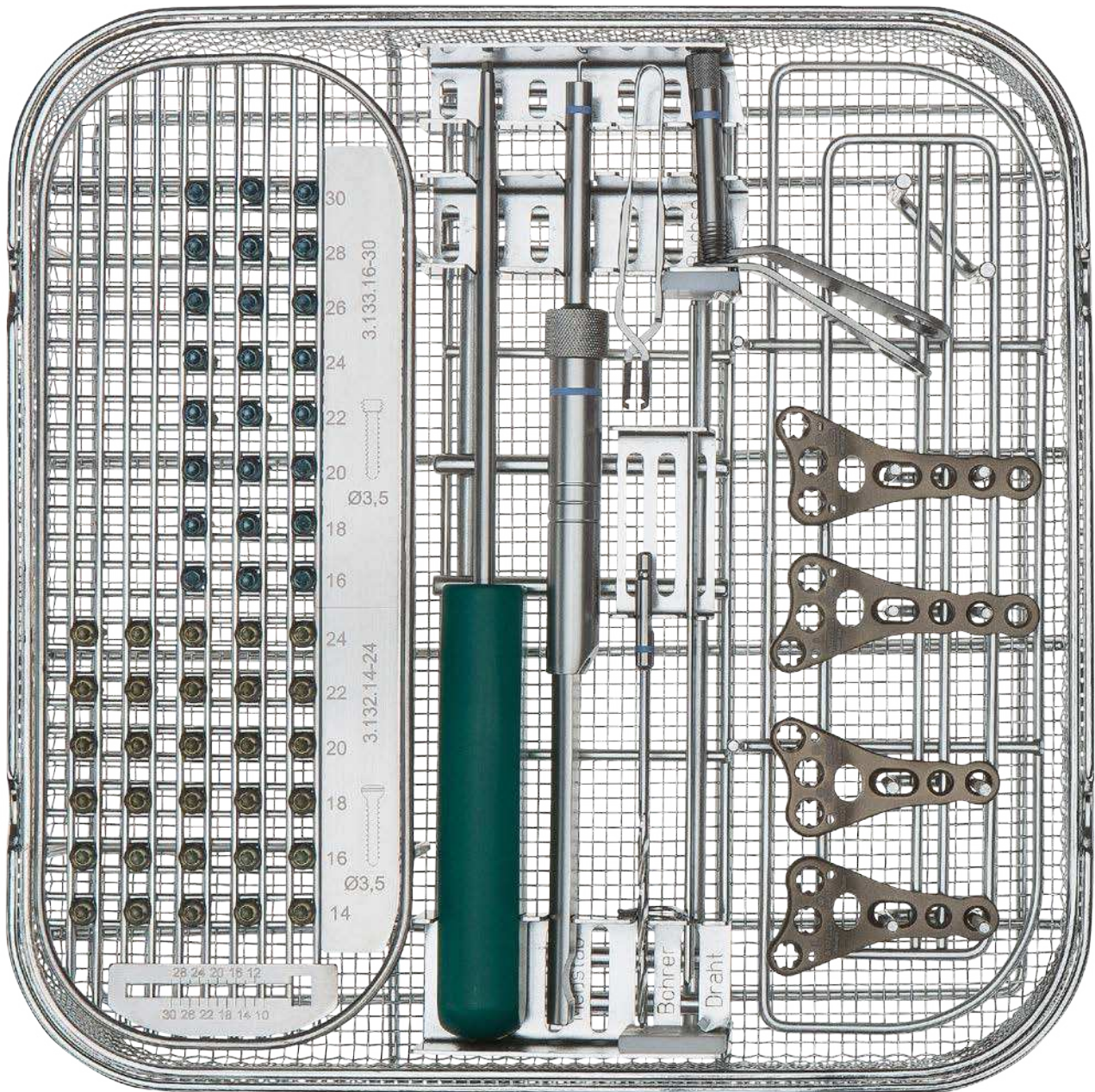

Set no. 19.1123.00

Radius

Distal radius plate 3.5 conversion



angle-stable; for screws Ø 3.5 mm; titanium



Item no. 5.9802.35

Item no.	Item description	EAN
----------	------------------	-----

Distal radius plate 3.5 conversion

5.9802.35	Distal radius plate for osteotomy 3.5; 3/5 holes; 69x10mm; right; titanium; plate thickness 3,0mm	 4047075130108
5.9812.35	Distal radius plate for osteotomy 3.5; 3/5 holes; 69x10mm; left; titanium; plate thickness 3,0mm	 4047075130115

Radius

Module Radius plates 3,5 - SFI

for SFI-Implants



Set - complete: 19.539.00

Set - autoclavable container: 19.538.00

Plates

Item designation	Code-No.	Quantity
Dist. Radius plate „Classic“ w. con. thread 3.5; 3/3h; 51 x 10; R, T	5.876.33	1
Dist. Radius plate „Classic“ w. con. thread 3.5; 3/4h; 59 x 10; R, T	5.876.34	1
Dist. Radius plate „Classic“ w. con. thread 3.5; 3/6h; 76 x 10; R, T	5.876.36	1
Dist. Radius plate „Classic“ w. con. thread 3.5; 3/3h; 51 x 10; L, T	5.877.33	1
Dist. Radius plate „Classic“ w. con. thread 3.5; 3/4h; 59 x 10; L, T	5.877.34	1
Dist. Radius plate „Classic“ w. con. thread 3.5; 3/6h; 76 x 10; L, T	5.877.36	1



■ optional implants - all further radius plates up to a Length of 136 mm

Storage

Item designation	Code-No.	Quantity
perforated autoclavable container with inset for Module Dist. Tibia plate	19.538.00	1

Module Radius plates 3,5 - SFI for SFI-implants



ULNA

Königsee Implantate

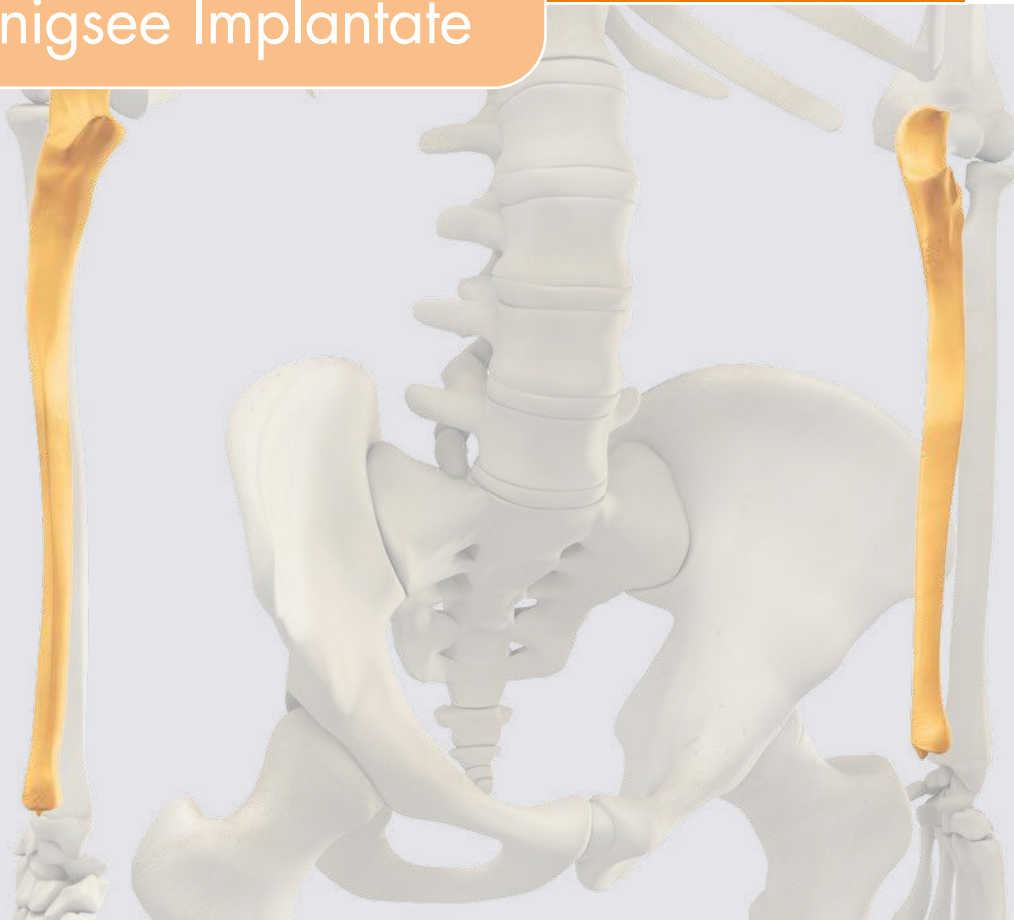

Your Partner in Osteosynthesis

Distal ulna plate 2.0







angle-stable; for screws \varnothing 2.0 mm; plate thickness 1.5 mm; titanium



Item no. 5.888.43



Item no. 5.889.43

Item no.	Item description	EAN
5.888.43	distal ulna plate with conical thread 2.0; 4/3 holes; 38 x 6 mm; right; titanium	 4047075116669
5.888.45	distal ulna plate with conical thread 2.0; 4/5 holes; 53 x 6 mm; right; titanium	 4047075110735
5.888.46	distal ulna plate with conical thread 2.0; 4/6 holes; 60 x 6 mm; right; titanium	 4047075116676
5.889.43	distal ulna plate with conical thread 2.0; 4/3 holes; 38 x 6 mm; left; titanium	 4047075116645
5.889.45	distal ulna plate with conical thread 2.0; 4/5 holes; 53 x 6 mm; left; titanium	 4047075110728
5.889.46	distal ulna plate with conical thread 2.0; 4/6 holes; 60 x 6 mm; left; titanium	 4047075116652

Set Distal ulna plate 2.0

angle-stable; titanium; Set no. 19.506.00



Item no. 5.888.43







Item no. 5.889.43



Set no. 19.506.00  Internal hexagon

Item no.	Item description	Quant.
Implants – plates*		
distal ulna plate with conical thread 2.0; titanium		
5.888.43	4/3 holes; 38 x 6 mm; right	1
5.888.46	4/6 holes; 60 x 6 mm; right	1
5.889.43	4/3 holes; 38 x 6 mm; left	1
5.889.46	4/6 holes; 60 x 6 mm; left	1

Implants – screws		
cortical screw with conical head thread; Ø 2.0 mm; fully threaded; self tapping; titanium		
		
 Internal hexagon		
3.114.10	length 10 mm	5
3.114.12	length 12 mm	5
3.114.14	length 14 mm	5
3.114.16	length 16 mm	5

cortical screw; Ø 2.0 mm; fully threaded; self tapping; titanium		
		
 Internal hexagon		
3.110.10	length 10 mm	5
3.110.12	length 12 mm	5
3.110.14	length 14 mm	5

Item no.	Item description	Quant.
Instruments		
2.904.20	drill bit for quick coupling; Ø 1.5 x 105; spiral length 30; double spiral	1
2.977.06	drill guide for angle stable screwing 2.0; length 45	2
2.9401.15A	hex screwdriver with handle for screw Ø 1.5 and Ø 2.0; wrench width 1.5; detachable	1
2.953.51	gauge with clasp for screws Ø 2.0; measuring range 44	1
2.954.01	screw forceps; self holding	1

Container		
19.507.00	perforated autoclavable container w.inset f.instr./impl. angle stable plate MF	1

*Optionally available: 5.888.45 und 5.889.45

Set Distal ulna plate 2.0

angle-stable; titanium; Set no. 19.506.00

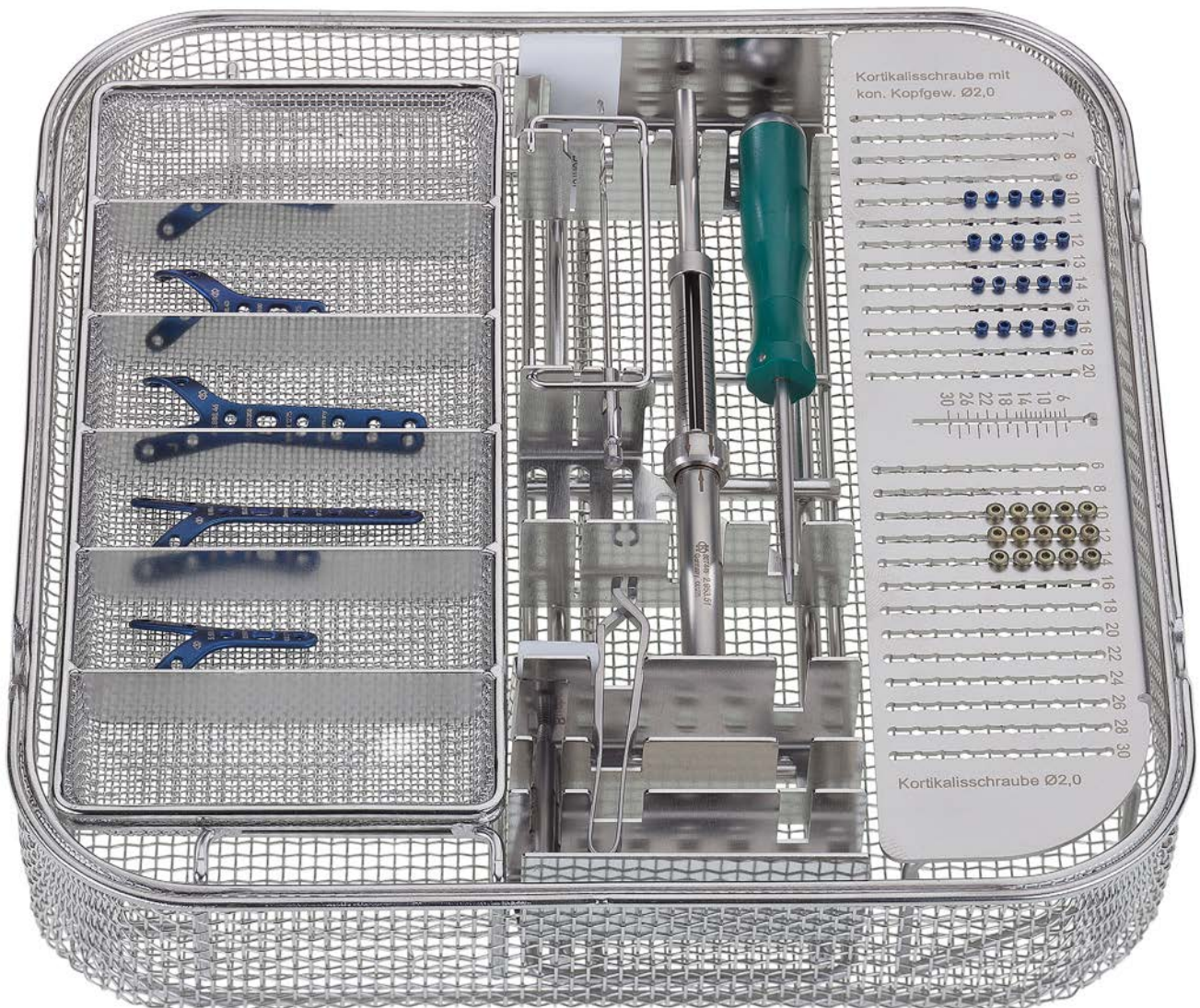

Set no. 9.506.00  Internal hexagon

HAND

Königsee Implantate

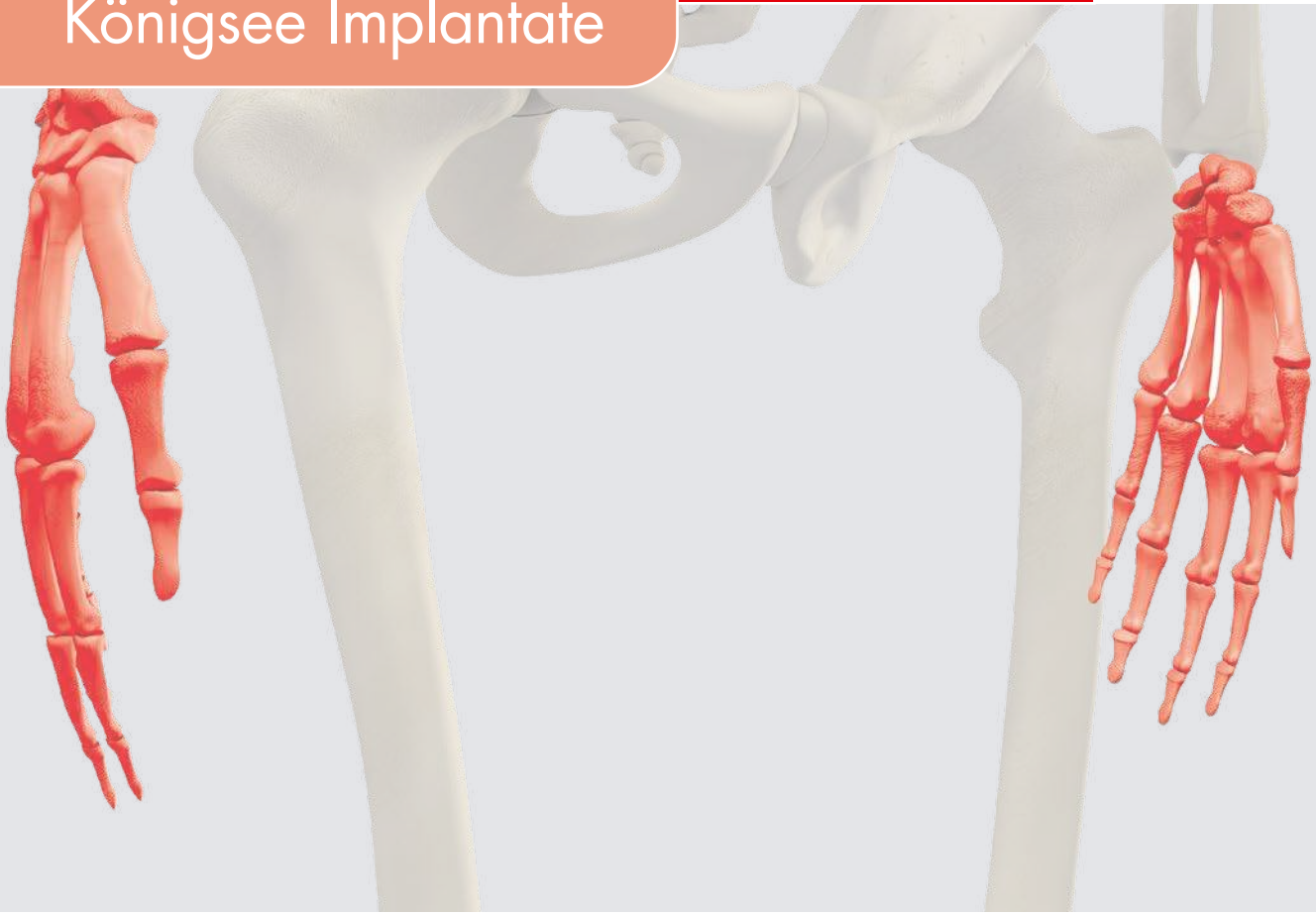

Your Partner in Osteosynthesis

Hand plates Mini

standard; for screws \varnothing 1.5 mm; \varnothing 2.0 mm; \varnothing 2.7 mm; titanium



Item no. 5.900.05



Item no. 5.402.20



Item no. 5.416.49



Item no. 5.930.06

Item no.	Item description	EAN
Straight plate Mini 1.5 – plate thickness 1.0 mm		
5.404.15	straight mini plate 1.5; 20 holes; 100 x 4 mm; titanium	 4047075004942
H-plate Mini 1.5 – plate thickness 0.9 mm		
5.402.15	mini H-plate 1.5; 4 holes; 9 x 8.2 mm; titanium	 4047075004614
Straight plate Mini 2.0 – plate thickness 1.0 mm		
5.900.03	straight mini plate with round holes 2.0; 3 holes; 17 x 5 mm; titanium	 4047075011124
5.900.04	straight mini plate with round holes 2.0; 4 holes; 23 x 5 mm; titanium	 4047075011384
5.900.05	straight mini plate with round holes 2.0; 5 holes; 29 x 5 mm; titanium	 4047075011391
5.900.06	straight mini plate with round holes 2.0; 6 holes; 35 x 5 mm; titanium	 4047075011407
H-plate Mini 2.0 – plate thickness 0.9 mm		
5.402.20	mini H-plate 2.0; 4 holes; 12 x 11 mm; titanium	 4047075004874
T-Plate Mini 2.0 – plate thickness 1.5 mm		
5.416.39	mini T-plate 2.0/2.0; 3/9L; 50 x 5 mm; titanium	 4047075005024
5.416.49	mini T-plate 2.0/2.0; 4/9L; 50 x 5 mm; titanium	 4047075005031
T-Plate Mini 2.0 long hole – plate thickness 1.0 mm		
5.930.02	mini T-plate 2.0; 2 holes; 22 x 5.5 mm; long hole in shank; titanium	 4047075011483
5.930.03	mini T-plate 2.0; 3 holes; 29 x 5.5 mm; long hole in shank; titanium	 4047075011711
5.930.04	mini T-plate 2.0; 4 holes; 36 x 5.5 mm; long hole in shank; titanium	 4047075011728
5.930.05	mini T-plate 2.0; 5 holes; 43 x 5.5 mm; long hole in shank; titanium	 4047075011735
5.930.06	mini T-plate 2.0; 6 holes; 50 x 5.5 mm; long hole in shank; titanium	 4047075011742
5.930.07	mini T-plate 2.0; 7 holes; 57 x 5.5 mm; long hole in shank; titanium	 4047075011537
5.930.08	mini T-plate 2.0; 8 holes; 64 x 5.5 mm; long hole in shank; titanium	 4047075011766

Hand plates Mini

standard; for screws \varnothing 1.5 mm; \varnothing 2.0 mm; \varnothing 2.7 mm; titanium



Item no. 5.850.06

Item no.	Item description	EAN
T-Plate Mini 2.0/2.7 – plate thickness 1.0 mm		
5.850.02	mini T-plate with round holes 2.0 and 2.7; 2 holes; 24 x 7 mm; titanium	 4047075010196
5.850.03	mini T-plate with round holes 2.0 and 2.7; 3 holes; 32 x 7 mm; titanium	 4047075010370
5.850.04	mini T-plate with round holes 2.0 and 2.7; 4 holes; 40 x 7 mm; titanium	 4047075010325
5.850.05	mini T-plate with round holes 2.0 and 2.7; 5 holes; 48 x 7 mm; titanium	 4047075010394
5.850.06	mini T-plate with round holes 2.0 and 2.7; 6 holes; 56 x 7 mm; titanium	 4047075010400
5.850.07	mini T-plate with round holes 2.0 and 2.7; 7 holes; 64 x 7 mm; titanium	 4047075010417
5.850.08	mini T-plate with round holes 2.0 and 2.7; 8 holes; 72 x 7 mm; titanium	 4047075010424

Hand plates Mini

standard; for screws Ø 1.5 mm; Ø 2.0 mm; Ø 2.7 mm; stainless steel



Item no. 4.404.15



Item no. 4.402.20



Item no. 4.900.05

















Item no. .416.37

Item no.	Item description	EAN
Straight plate Mini 1.5 – plate thickness 0.9 mm		
4.404.04	straight mini plate 1.5; 4 holes; 20 x 4 mm; stainless steel	4047075105076
4.404.06	straight mini plate 1.5; 6 holes; 30 x 4 mm; stainless steel	4047075105083
4.404.07	straight mini plate 1.5; 7 holes; 35 x 4 mm; stainless steel	4047075105090
4.404.08	straight mini plate 1.5; 8 holes; 40 x 4 mm; stainless steel	4047075105106
4.404.15	straight mini plate 1.5; 20 holes; 100 x 4 mm; stainless steel	4047075104987
H-plate Mini 1.5 – plate thickness 0.9 mm		
4.402.15	mini H-plate 1.5; 4 holes; 9 x 8.2 mm; stainless steel	4047075104895
Straight plate Mini 2.0 – plate thickness 1.0 mm		
4.900.03	straight mini plate with round holes 2.0; 3 holes; 17 x 5 mm; stainless steel	4047075048151
4.900.04	straight mini plate with round holes 2.0; 4 holes; 23 x 5 mm; stainless steel	4047075048168
4.900.05	straight mini plate with round holes 2.0; 5 holes; 29 x 5 mm; stainless steel	4047075048199
4.900.06	straight mini plate with round holes 2.0; 6 holes; 35 x 5 mm; stainless steel	4047075048205
4.900.07	straight mini plate with round holes 2.0; 7 holes; 41 x 5 mm; stainless steel	4047075048212
4.900.08	straight mini plate with round holes 2.0; 8 holes; 47 x 5 mm; stainless steel	4047075048052
4.900.20	straight mini plate with round holes 2.0; 20 holes; 119 x 5 mm; stainless steel	4047075048267
H-plate Mini 2.0 – plate thickness 0.9 mm		
4.402.20	mini H-plate 2.0; 4 holes; 12 x 11 mm; stainless steel	4047075105052
T-Plate Mini 2.0 – plate thickness 1.5 mm		
4.416.37	mini T-plate 2.0/2.0; 3/7L; 40 x 5 mm; stainless steel	4047075106264
4.416.39	mini T-plate 2.0/2.0; 3/9L; 50 x 5 mm; stainless steel	4047075106417
4.416.49	mini T-plate 2.0/2.0; 4/9L; 50 x 5 mm; stainless steel	4047075106288

Hand plates Mini

standard; for screws Ø 1.5 mm; Ø 2.0 mm; Ø 2.7 mm; stainless steel

Item no.	Item description	EAN
T-Plate Mini 2.0 long hole – plate thickness 1.0 mm		
4.930.02	mini T-plate 2.0; 2 holes; 22 x 5.5 mm; long hole in shank; stainless steel	 4047075047727
4.930.03	mini T-plate 2.0; 3 holes; 29 x 5.5 mm; long hole in shank; stainless steel	 4047075047956
4.930.04	mini T-plate 2.0; 4 holes; 36 x 5.5 mm; long hole in shank; stainless steel	 4047075002133
4.930.05	mini T-plate 2.0; 5 holes; 43 x 5.5 mm; long hole in shank; stainless steel	 4047075002160
4.930.06	mini T-plate 2.0; 6 holes; 50 x 5.5 mm; long hole in shank; stainless steel	 4047075002177
4.930.07	mini T-plate 2.0; 7 holes; 57 x 5.5 mm; long hole in shank; stainless steel	 4047075002184
4.930.08	mini T-plate 2.0; 8 holes; 64 x 5.5 mm; long hole in shank; stainless steel	 4047075047734
4.930.09	mini T-plate 2.0; 9 holes; 71 x 5.5 mm; long hole in shank; stainless steel	 4047075002207
T-Plate Mini 2.0/2.7 – plate thickness 1.0 mm		
4.850.02	mini T-plate with round holes 2.0 and 2.7; 2 holes; 24 x 7 mm; stainless steel	 4047075048663
4.850.03	mini T-plate with round holes 2.0 and 2.7; 3 holes; 32 x 7 mm; stainless steel	 4047075048670
4.850.04	mini T-plate with round holes 2.0 and 2.7; 4 holes; 40 x 7 mm; stainless steel	 4047075048724
4.850.05	mini T-plate with round holes 2.0 and 2.7; 5 holes; 48 x 7 mm; stainless steel	 4047075048731
4.850.06	mini T-plate with round holes 2.0 and 2.7; 6 holes; 56 x 7 mm; stainless steel	 4047075048755
4.850.07	mini T-plate with round holes 2.0 and 2.7; 7 holes; 64 x 7 mm; stainless steel	 4047075048762
4.850.08	mini T-plate with round holes 2.0 and 2.7; 8 holes; 72 x 7 mm; stainless steel	 4047075048595

Hand plates Mini 2.0 as

angle-stable; for screws Ø 2.0 mm; plate thickness 1.2 mm; titanium



Item no. 5.9012.05



Item no. 5.9022.04



Item no. 5.9052.04S



Item no. 5.9332.36



Item no. 5.9012.13



Item no. 5.9032.06



Item no. 5.9312.26



Item no. 5.9342.34

Item no.	Item description	EAN
Straight plate Mini 2.0 as		
5.9012.05	straight plate with conical thread 2.0; 5 holes; 29 x 5 mm; titanium	4047075129799
5.9012.13	straight plate with conical thread 2.0; 13 holes; 77 x 5 mm; titanium	4047075129805
Straight Plate Mini 2.0 as round bridge		
5.9022.04	mini bridge plate with conical thread 2.0; 4 holes; 29 x 5 mm; titanium	4047075148806
K-Plate Mini 2.0 as		
5.9032.06	K-plate with conical thread 2.0; 6 holes; length 37 mm; titanium	4047075148813
Double bridge plate 2.0 as		
5.9052.04S	double bridge plate with conical thread 2.0; 4 holes; 15 x 11 mm; oblique; titanium	4047075129812
5.9052.07S	double bridge plate with conical thread 2.0; 7 holes; 25 x 10 mm; oblique; titanium	4047075148820
5.9052.10	double bridge plate with conical thread 2.0; 10 holes; 45 x 11 mm; straight; titanium	4047075129829
T-Plate Mini 2.0 as narrow		
5.9312.24	mini T-plate with conical thread 2.0/2.0; 2/4 holes; 30 x 5 mm; titanium	4047075129836
5.9312.26	mini T-plate with conical thread 2.0/2.0; 2/6 holes; 42 x 5 mm; titanium	4047075158508
5.9312.28	mini T-plate with conical thread 2.0/2.0; 2/8 holes; 54 x 5 mm; titanium	4047075158515
T-Plate Mini 2.0 as broad		
5.9332.34	mini T-plate with conical thread 2.0/2.0; 3/4 holes; 30 x 5 mm; straight; titanium	4047075129850
5.9332.36	mini T-plate with conical thread 2.0/2.0; 3/6 holes; 42 x 5 mm; straight; titanium	4047075158539
5.9332.38	mini T-plate with conical thread 2.0/2.0; 3/8 holes; 54 x 5 mm; straight; titanium	4047075158546
T-Plate Mini 2.0 as Δ		
5.9342.34	mini T-plate with conical thread 2.0/2.0; 2/5 holes; 33 x 5 mm; titanium	4047075148837

Hand plates Mini 2.0 as

angle-stable; for screws \varnothing 2.0 mm; plate thickness 1.2 mm; titanium



Item no. 5.9322.34

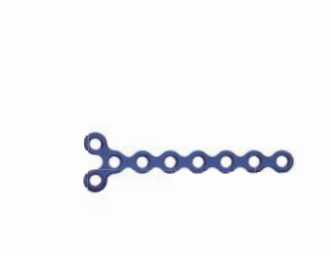

Item no. 5.9322.36



Item no. 5.9322.38

Item no.	Item description	EAN
5.9322.34	mini T-plate with conical thread 2.0/2.0; 3/4 holes; 33 x 5 mm; y-form; titanium	 4047075129843
5.9322.36	mini T-plate with conical thread 2.0/2.0; 3/6 holes; 45 x 5 mm; y-form; titanium	 4047075149612
5.9322.38	mini T-plate with conical thread 2.0/2.0; 3/8 holes; 57 x 5 mm; y-form; titanium	 4047075149629

Hand plates Mini 2.0 as

angle-stable; for screws \varnothing 2.0 mm; stainless steel



Item no. 4.9002.20

Item no.	Item description	EAN
Straight plate Mini 2.0 as – plate thickness 1.5 mm		
4.9002.20	straight mini plate with conical thread 2.0; 20 holes; 119 x 5 mm; stainless steel	 4047075145201
Straight plate Mini 2.0 as bridge – plate thickness 2.0 mm		
4.4555.04	straight plate with conical thread and bridge 2.0; 4 holes; 27 x 5 mm; bridge 12; div.; stainless steel	 4047075118489
4.4555.06	straight plate with conical thread and bridge 2.0; 6 holes; 37 x 5 mm; bridge 12; div.; stainless steel	 4047075118496
4.4555.08	straight plate with conical thread and bridge 2.0; 8 holes; 47 x 5 mm; bridge 12; div.; stainless steel	 4047075117512
4.4555.10	straight plate with conical thread and bridge 2.0; 10 holes; 57 x 5 mm; bridge 12; div.; stainless steel	 4047075118502

Set Hand plates Mini 2.0 as

angle-stable; for screws Ø 2.0 mm; titanium; Set no. 19.508.00



Item no. 5.9012.05



Item no. 5.9012.13



Item no. 5.9052.10



Item no. 5.9052.04S



Item no. 5.9312.24



Item no. 5.9332.34





Item no. 5.9322.34



Set no. 19.508.00 Internal hexagon

Item no.	Item description	Quant.
Implants – plates		
Hand plates Mini 2.0 as; angle-stable; for screws 2.0; titanium		
5.9012.05	straight plate; 5 holes; 29x5 mm	1
5.9012.13	straight plate; 13 holes; 77x5 mm	1
5.9052.10	double bridge plate ; 10 holes; 45x11 mm; straight	1
5.9052.04S	double bridge plate; 4 holes; 15x11 mm; oblique	1
5.9312.24	mini T-plate; 2/4 holes; 30x5 mm	1
5.9332.34	mini T-plate; 3/4 holes; 30x5 mm; straight	1
5.9322.34	mini T-plate; 3/4 holes; 33x5 mm; y-form	1

Implants – screws		
Cortical screw with conical head thread 2.0; fully threaded; self tapping; titanium		
  Internal hexagon		
3.114.08	length 8 mm	5
3.114.09	length 9 mm	5
3.114.10	length 10 mm	5
3.114.11	length 11 mm	5
3.114.12	length 12 mm	5
3.114.13	length 13 mm	5
3.114.14	length 14 mm	5
3.114.15	length 15 mm	5
3.114.16	length 16 mm	5
3.114.18	length 18 mm	5
3.114.20	length 20 mm	5

Item no.	Item description	Quant.
Instruments		
2.904.20	drill bit for quick coupling, Ø1.5x105, spiral length 30, double spiral	1
2.977.06a	drill guide for angle stable screwing 2.0, length 45	2
2.9401.15A	hex screwdriver with handle for screw Ø1.5 and Ø2.0, wrench width 1.5, detachable	1
2.953.51	gauge with clasp for screws Ø2.0, measuring range 44	1
2.954.01	screw forceps, self holding	1
2.948.15A	screwdriver for extraction for quick coupling, wrench size 1.5	1
10.428.01	bending forceps for mini plates 1.5 until 2.0	1

Wires		
6.031.08	Kirschnerdraht m. Trokarsp. u. rd. Ende; Ø0,8x150; S	5

Container		
19.507.00	perforated autoclavable container w. inset f. instr./impl. angle stable plate MF	1

Set Hand plates Mini 2.0 as

angle-stable; for screws \varnothing 2.0 mm; titanium; Set no. 19.508.00

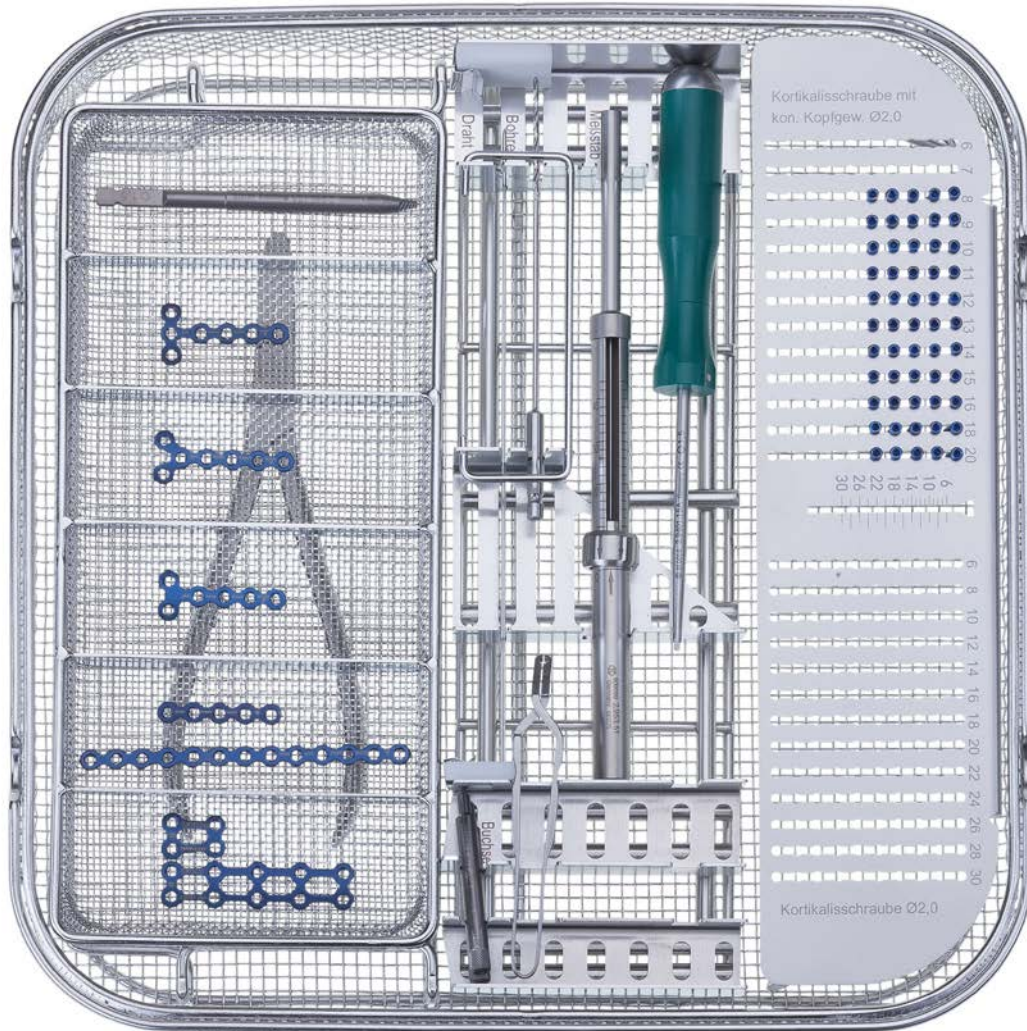

Set no. 19.508.00  Internal hexagon

Ring plates vas

variable angle-stable; for screws \varnothing 2.0 mm; \varnothing 2.7 mm; plate thickness 1.5 mm; titanium



Item no. 5.9953.14





Item no. 5.9953.14



Item no. 5.9953.16



Item no. 5.9953.16

Item no.	Item description	EAN
Ring plate 2.0 vas		
5.9953.14	ring plate with conical thread 2.0; 7 holes; outside \varnothing 14.0 mm; titanium	 4047075129867
Ring plate 2.7 vas		
5.9953.16	ring plate with conical thread 2.7; 5 holes; outside \varnothing 16.5 mm; titanium	 4047075129874

Set Ring plates vas

variable angle-stable; two levels; titanium; Set no. 19.439.00

LEVEL 1



Item no.	Item description	Quant.
Implants – plates		
Ring plate with conical thread; variable angle-stable; titanium		
5.9953.14	Ring plate 2.0 vas; 7 holes; Ø 14.0 mm	1
5.9953.16	Ring plate 2.7 vas; 5 holes; Ø 16.5 mm	1

Implants – screws		
Cortical screw 2.0; fully threaded; self tapping; titanium; titanium Internal hexagon		
3.110.08	length 8 mm	2
3.110.10	length 10 mm	2
3.110.12	length 12 mm	2
3.110.14	length 14 mm	2
3.110.16	length 16 mm	2
3.110.18	length 18 mm	2
3.110.20	length 20 mm	2

Cortical screw with conical head thread 2.0; fully threaded; self tapping; titanium Internal hexagon		
3.114.08	length 8 mm	5
3.114.10	length 10 mm	5
3.114.12	length 12 mm	5
3.114.14	length 14 mm	5
3.114.16	length 16 mm	5
3.114.18	length 18 mm	5
3.114.20	length 20 mm	5

Item no.	Item description	Quant.
Implants – screws		
Cortical screw with conical head thread 2.7; fully threaded; self tapping; titanium Internal hexagon		
3.125.08	length 8 mm	5
3.125.10	length 10 mm	5
3.125.12	length 12 mm	5
3.125.14	length 14 mm	5
3.125.16	length 16 mm	5
3.125.18	length 18 mm	5
3.125.20	length 20 mm	5

Instruments		
2.954.01	screw forceps, self holding	1
2.977.06	drill guide for angle stable screwing 2.0, length 45	2

LEVEL 2

Instruments		
2.904.03	drill bit for quick coupling, Ø2x105, spiral length 30, double spiral	1
2.904.20	drill bit for quick coupling, Ø1.5x105, spiral length 30, double spiral	1
2.9102.14	cutter 80° for quick coupling, for ring plate Ø 14.0	1
2.9102.16	cutter 100° for quick coupling, for ring plate Ø 16.0	1
2.9406.25	hex screwdriver with handle for screws Ø2.7-Ø4.0, AF2.5, conical	1

Set Ring plates vas

variable angle-stable; two levels; titanium; Set no. 19.439.00

Item no.	Item description	Quant.
Container		
19.438.00	perforated autoclavable container with inset for instruments and ring plates	1

Item no.	Item description	Quant.
2.9401.15A	hex screwdriver with handle for screw Ø 1.5 and Ø 2.0, wrench width 1.5, detachable	1
2.953.51	gauge with clasp for screws Ø 2.0, measuring range 44	1
2.953.65	gauge w. clasp for screws Ø 2.7, measuring range 60	1
2.977.10	drill guide w.handle for variable angle stable screwing, mini fragment, length 45	1
2.977.11	drill guide for angle stable screwing 2.7, length 44	2
2.977.14	drill guide for variable angle stable screwing 2.0, length 45	1

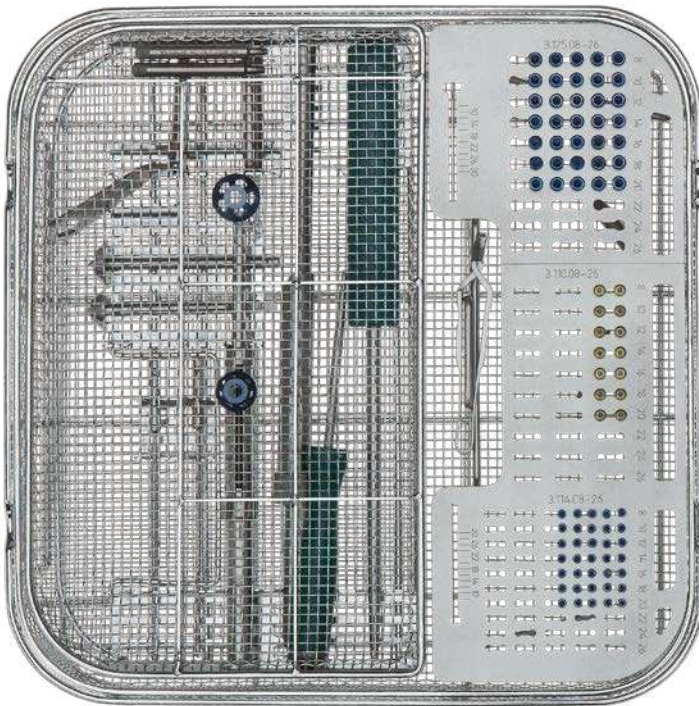

Set no. 19.439.00 Complete  Internal hexagon

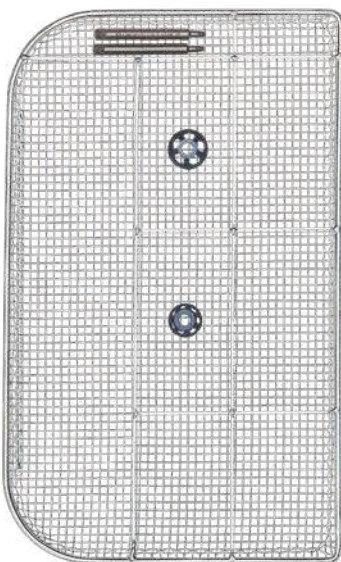

Set no. 19.439.00 Level 1

Set no. 19.439.00 Level 2

Hand arthrodesis plate

standard; for screws \varnothing 2.7/3.5 mm; titanium and stainless steel



item no. 5.804.08









item no. 5.804.11



item no. 5.805.08



item no. 5.816.09

Item no.	Item description	EAN
hand arthrodesis plate; titanium		
5.804.08	plate for arthrodesis with standard bending 2.7/3.5; 8 holes; 112x12; plate thickness in the bend 4.0 mm; titanium	 4047075008889
5.804.11	plate for arthrodesis with standard bending 2.7/3.5; 11 holes; 151x11; plate thickness in the bend 3.8 mm; titanium	 4047075057849
5.805.08	plate for arthrodesis with short bending 2.7/3.5; 8 holes; 112x12; plate thickness in the bend 4.0 mm; titanium	 4047075008896
5.816.09	plate for arthrodesis 2.7/3.5; 9 holes; 110x12; straight; plate thickness 4.0 mm; titanium	 4047075009350
hand arthrodesis plate; stainless steel		
4.804.08	plate for arthrodesis with standard bending 2.7/3.5; 8 holes; 112x12; plate thickness in the bend 4.0 mm; stainless steel	 4047075051090
4.805.08	plate for arthrodesis with short bending 2.7/3.5; 8 holes; 112x12; plate thickness in the bend 4.0 mm; stainless steel	 4047075051373
4.816.09	plate for arthrodesis 2.7/3.5; 9 holes; 110x12; straight; plate thickness 4.0 mm; stainless steel	 4047075049912

Hand Arthrodesis Plate vas

variable angle-stable; for screws Ø 2.7/3.5 mm; head 5.0; titanium



Item no. 5.9963.3340







Item no. 5.9963.3342



Item no. 5.9963.3350



Item no. 5.9963.4540

Item no.	Item description	EAN
Hand Arthrodesis Plate vas – plate thickness 3.0 mm; plate thickness side 2.0 mm		
5.9963.3340	hand arthrodesis plate for screws 2.7; 3/3 holes; 4°; offset 0; var.angle stable; titanium	 4047075152964
5.9963.3342	hand arthrodesis plate for screws 2.7; 3/3 holes; 4°; offset 2; var.angle stable; titanium	 4047075152971
5.9963.3350	hand arthrodesis plate for screws 2.7; 3/3 holes; 5°; offset 0; var.angle stable; titanium	 4047075152988
Hand Arthrodesis Plate vas – plate thickness 4.0 mm; plate thickness side 2.0 mm		
5.9963.4540	hand arthrodesis plate for screws 2.7; 4/5 holes; 4°; offset 0; var.angle stable; titanium	 4047075152995

Set Hand Arthrodesis Plate vas

variable angle-stable; for screws Ø 2.7/3.5 mm; head 5.0; titanium; Set no. 19.671.020



Item no. 5.9963.3340



Item no. 5.9963.3342



Item no. 5.9963.3350



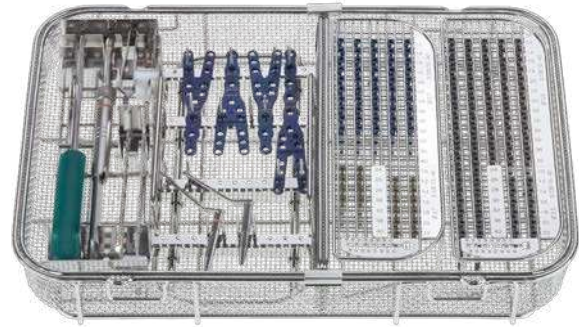

Item no. 5.9963.4540





Set no. 19.671.020 Internal hexagon

Item no.	Item description	Quant.
Implants – plates		
Hand Arthrodesis Plate vas; variable angle-stable; titanium		
5.9963.3340	3/3 holes; 4°; offset 0	1
5.9963.3342	3/3 holes; 4°; offset 2	1
5.9963.3350	3/3 holes; 5°; offset 0	1
5.9963.4540	4/5 holes; 4°; offset 0	1

Implants – screws		
Cortical screw; Ø 2.7; fully threaded; self tapping; flat head; titanium		
 Internal hexagon		
3.128.12	length 12 mm	2
3.128.14	length 14 mm	2
3.128.16	length 16 mm	2
3.128.18	length 18 mm	2
3.128.20	length 20 mm	2
3.128.22	length 22 mm	2
3.128.24	length 24 mm	2
3.128.26	length 26 mm	2
3.128.28	length 28 mm	2
3.128.30	length 30 mm	2

Cortical screw with conical head thread; Ø 2.7; fully threaded; s.t.; titanium		
 Internal hexagon		
3.125.12	length 12 mm	5
3.125.14	length 14 mm	5
3.125.16	length 16 mm	5
3.125.18	length 18 mm	5

Item no.	Item description	Quant.
Implants – screws		
cortical screw; Ø 3.5; fully threaded; head 5.0; s.t.; titanium; TiOB®		
 Internal hexagon		
3.138.12	length 12 mm	2
3.138.14	length 14 mm	2
3.138.16	length 16 mm	2
3.138.18	length 18 mm	2
3.138.20	length 20 mm	2
3.138.22	length 22 mm	2
3.138.24	length 24 mm	2
3.138.26	length 26 mm	2
3.138.28	length 28 mm	2
3.138.30	length 30 mm	2
3.138.32	length 32 mm	2
3.138.36	length 36 mm	2
3.138.40	length 40 mm	2

cortical screw with conical head thread; Ø 3.5; fully threaded; head 5.0; s.t.; titanium; TiOB®		
 Internal hexagon		
3.136.12	length 12 mm	5
3.136.14	length 14 mm	5
3.136.16	length 16 mm	5
3.136.18	length 18 mm	5
3.136.20	length 20 mm	5
3.136.22	length 22 mm	5
3.136.24	length 24 mm	5
3.136.26	length 26 mm	5

Set Hand Arthrodesis Plate vas

variable angle-stable; for screws Ø 2.7/3.5 mm; head 5.0; titanium; Set no. 19.671.020

Item no.	Item description	Quant.
3.125.20	length 20 mm	5
3.125.22	length 22 mm	5
3.125.24	length 24 mm	5
3.125.26	length 26 mm	5
3.125.28	length 28 mm	5
3.125.30	length 30 mm	5

Wires		
6.031.10	Kirschner wire with trocar point and round end, Ø1x150, st. st.	5

Container		
19.670.020	perforated autoclavable cont.w.inset f.instr./impl.hand arthrodesis plates,vas	1

Item no.	Item description	Quant.
3.136.28	length 28 mm	5
3.136.30	length 30 mm	5
3.136.32	length 32 mm	5
3.136.36	length 36 mm	5
3.136.40	length 40 mm	5

Instruments		
2.9406.25	hex screwdriver with handle for screws Ø2.7-Ø4.0, AF2.5, conical	1
2.977.10	drill guide w.handle for variable angle stable screwing, mini fragment, length 45	1
2.977.11	drill guide for angle stable screwing 2.7, length 44	2
2.977.12	drill guide with handle for variable angle stable screwing 3.5 with head Ø 5.0	1
2.977.13	drill guide for angle stable screws 3.5 with head Ø 5.0, length 44	2
2.904.04	drill bit for quick coupling, Ø2x125, spiral length 30, double spiral	1
2.904.06	drill bit for quick coupling, Ø2.5x125, spiral length 60, double spiral	1
2.953.65	gauge w. clasp for screws Ø2.7, measuring range 60	1
2.954.01	screw forceps, self holding	1

Set Hand Arthrodesis Plate vas

variable angle-stable; for screws \varnothing 2.7/3.5 mm; head 5.0; titanium; Set no. 19.671.020

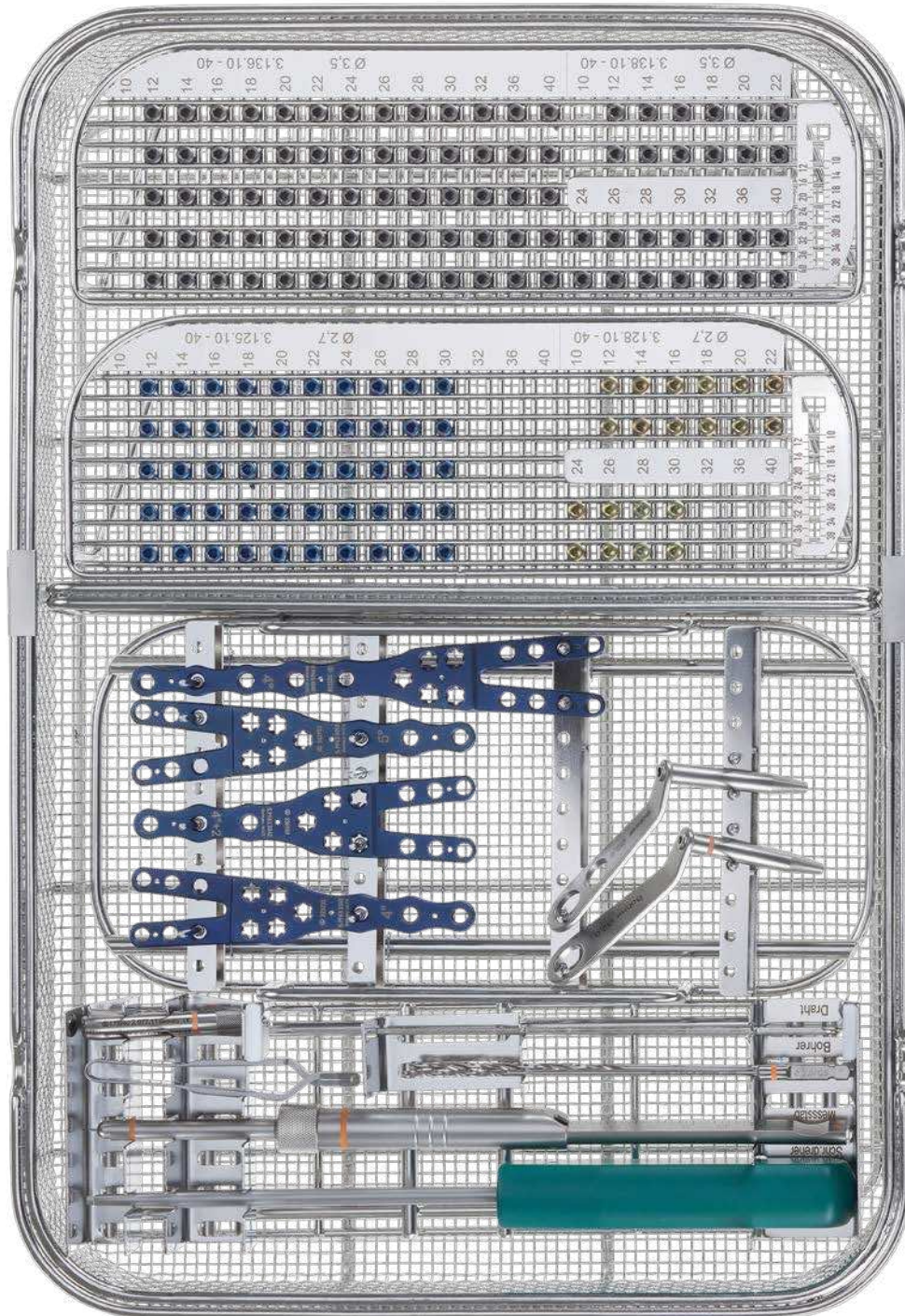

Set no. 19.671.020  Internal hexagon

FEMUR

Königsee Implantate

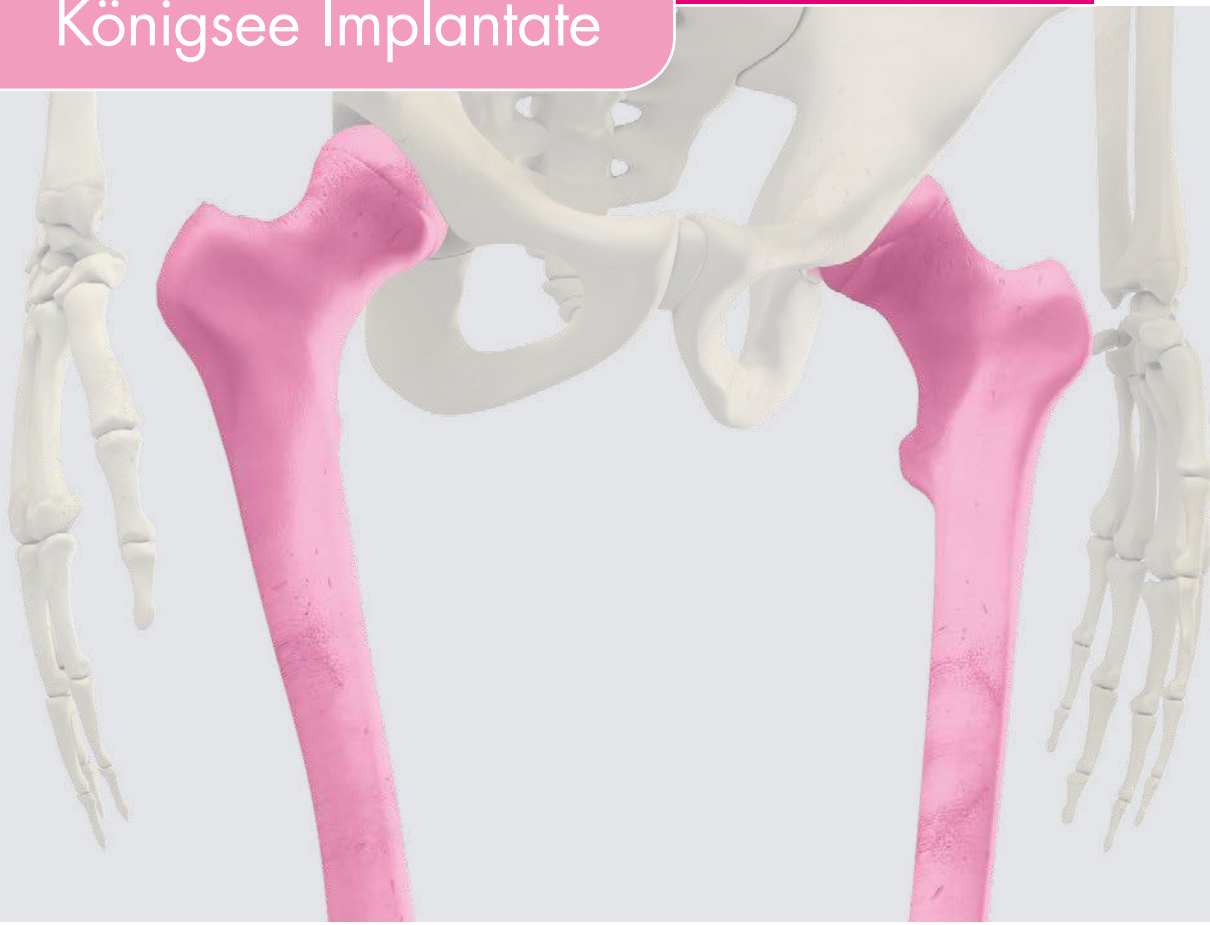

Your Partner in Osteosynthesis

RoSA® Extramedullary

Rotation-stable screw anchor for the extramedullary treatment; titanium; set no. 19.606.00



Item no. 7.306.70



Item no. 7.308.129



Item no. 7.307.80



Item no. 7.309.02



Set no. 19.606.00 Internal hexagon

Item no.	Item description	Quant.
Implants		
RoSA® - screw; Ø 10 mm; titanium		
7.306.50	length 50 mm; yellow	2
7.306.70	length 70 mm; pink	2
7.306.90	length 90 mm; green	2
RoSA® - blade, titanium		
7.307.60	length 60 mm; yellow	2
7.307.80	length 80 mm; pink	2
7.307.100	length 100 mm; green	2
RoSA® - plate; titanium		
7.308.122P1	122°; 1 hole	1
7.308.129P1	129°; 1 hole	1
7.308.136P1	136°; 1 hole	1
7.308.143P1	143°; 1 hole	1
7.308.122P3	122°; 3 hole	1
7.308.129P3	129°; 3 hole	1
7.308.136P3	136°; 3 hole	1
7.308.143P3	143°; 3 hole	1
7.308.122P5	122°; 5 hole	1
7.308.129P5	129°; 5 hole	1
7.308.136P5	136°; 5 hole	1
7.308.143P5	143°; 5 hole	1

Item no.	Item description	Quant.
Implants		
RoSA® - connecting screw; titanium		
7.309.01	RoSA® connecting screw; canulated Ø 2.55 mm for CH8	2
7.309.02	RoSA® connecting screw	2

Implants - screws		
Cortical screw; Ø 4,5 mm; fully threaded; self tapping; titanium		
3.152.34	length 34 mm	5
3.152.36	length 36 mm	5
3.152.38	length 38 mm	5
3.152.40	length 40 mm	5
3.152.42	length 42 mm	5
3.152.44	length 44 mm	5
3.152.46	length 46 mm	5
3.152.48	length 48 mm	5
3.152.50	length 50 mm	5
3.152.52	length 52 mm	5
3.152.55	length 55 mm	5
3.152.60	length 60 mm	5

RoSA® Extramedullary

Rotation-stable screw anchor for the extramedullary treatment; titanium; set no. 19.606.00

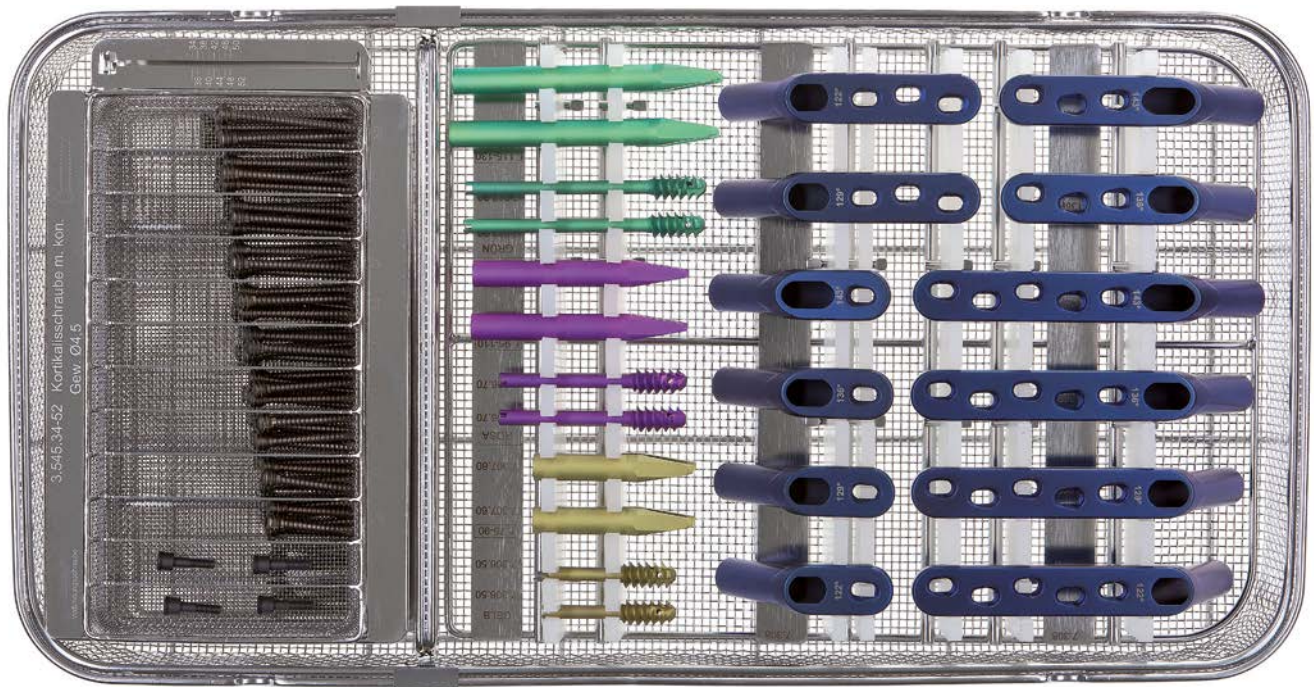

Set no. 19.606.00  Internal hexagon

Item no.	Item description	Quant.
Implants – screws		
	Cortical screw with conical head thread; Ø 4,5 mm; fully threaded; self tapping; titanium 	
3.545.34	length 34 mm	5
3.545.36	length 36 mm	5
3.545.38	length 38 mm	5
3.545.40	length 40 mm	5
3.545.42	length 42 mm	5
3.545.44	length 44 mm	5
3.545.46	length 46 mm	5
3.545.48	length 48 mm	5
3.545.50	length 50 mm	5
3.545.52	length 52 mm	5

Item no.	Item description	Quant.
Container		
19.605.00	perforated autoclavable container with inset for implants RoSA®	1

Instruments RoSA®

Set no. 19.608.00



Set no. 19.608.00  Internal hexagon

Item no.	Item description	Quant.
Instruments		
Level 1		
10.305.06	T-handle with 3 points coupling; length 85 mm	1
10.269.122	angle guide 122° for RoSA®	1
10.269.129	angle guide 129° for RoSA®	1
10.269.136	angle guide 136° for RoSA®	1
10.269.143	angle guide 143° for RoSA®	1
10.269.10	wire drill guide for RoSA®	1
10.269.11	impactor for K-wires Ø 3.0 mm for RoSA®	1
10.421.05	extraction forceps with notch for wires	1
10.269.20	direct measuring gauge for RoSA®; length 260 mm; measuring range up to 170 mm	1
10.269.30	RoSA® quadruple reamer	1
10.269.40	insertion instrument for RoSA®-screw	1

Item no.	Item description	Quant.
Wires		
6.031.30/270	Kirschner wire with trocar point and round end; Ø 3.0 x 270 mm for RoSA®; stainless steel	4
6.031.30/400	Kirschner wire with trocar point and round end; Ø 3.0 x 400 mm for RoSA®; stainless steel	2
6.031.30/320	Kirschner wire with trocar point and round end; Ø 3.0 x 320 mm for RoSA®; stainless steel	2

Container		
19.607.00	perforated autoclavable container with inset for instruments RoSA®	1

Instruments RoSA®

Set no. 19.608.00



Set no. 19.608.00  Internal hexagon

Item no.	Item description	Quant.
Instruments		
Level 2		
10.269.50	threaded rod M4 x 305.5 mm for RoSA®; stainless steel	1
10.269.51	screwing aid for rod M4 for RoSA®	1
10.269.60	guide sleeve Ø 6.0 x 260 mm for RoSA®-blade	1
10.269.61	Fixing sleeve M4 for guide sleeve Ø 6.0 x 260 mm for RoSA®	2
10.269.62	impactor for RoSA®-blade	1
10.264.24	plastic hammer	1
10.269.70	compression instrument with guiding pin for RoSA®	1
10.269.7115	distance sleeve Ø10 x 15 mm for RoSA®	2
10.269.7110	distance sleeve Ø 10 x 10 mm for RoSA®	2
10.269.72	compression nut; M4 for RoSA®	1
10.269.80	holding sleeve Ø 12 x 130 mm for RoSA®-connecting screw	1
10.269.81	guiding sleeve for Redon tube CH8 for RoSA®	1
10.269.82	drill bit for quick coupling; Ø 3.2 x 305 mm; spiral length 55 mm; with marking	1
10.269.83	universal drill guide with scaling; Ø 3.2 mm for RoSA®	1

Item no.	Item description	Quant.
Instruments		
10.269.84	drill guide with scaling for angle stable screwing for drill Ø 3.2 mm	1
2.953.90	gauge with clasp for screws Ø 4.5 mm and Ø 6.0 mm; measuring range 90 mm	1
2.927.45	tap for quick coupling for cortical screws; Ø 4.5 x 195 mm; thread 70 mm	1
2.954.01	screw forceps; self holding	1
2.9406.35/260	hex screwdriver with handle for screws Ø 4.5 mm - Ø 7.0 mm; AF 3.5 mm; length 260 mm	1
2.941.35/195	hex screwdriver inset for quick coupling for screw Ø 4.5 mm - 7.0 mm; length 195 mm; AF 3.5 mm	1
optional:		
2.9771.45	drill guide for angle stable compression hole; big fragment	1
2.977.02	drill guide for angle stable screwing; length 70 mm; big fragment	1

Instruments RoSA®

Set no. 19.608.00

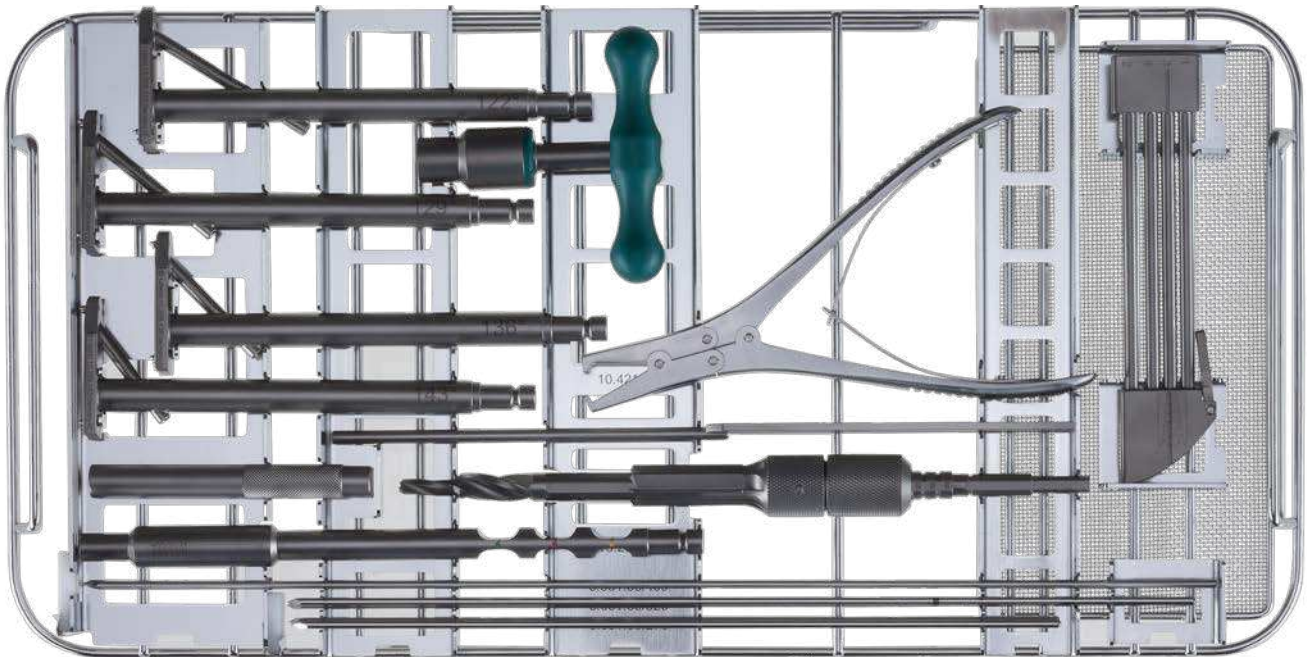

Set no. 19.608.00, upper level (1)  Internal hexagon

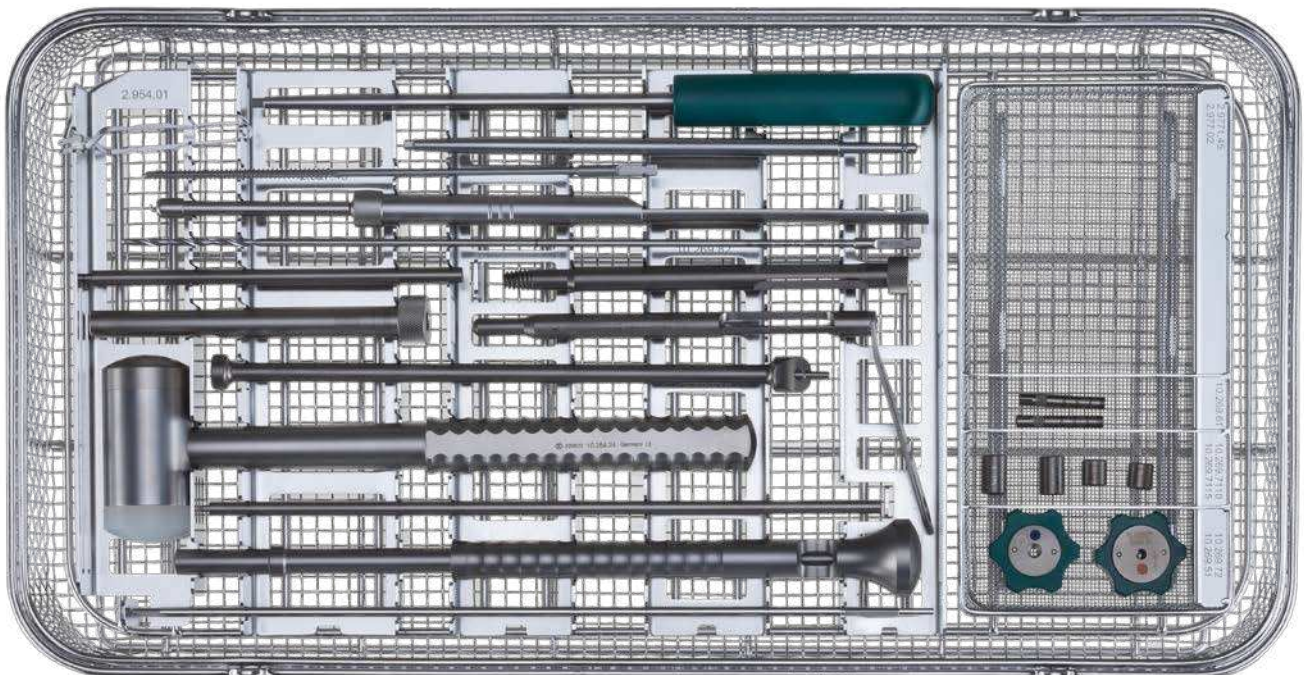

Set no. 19.608.00, lower level (2)  Internal hexagon

Instruments RoSA®

Set no. 19.608.00

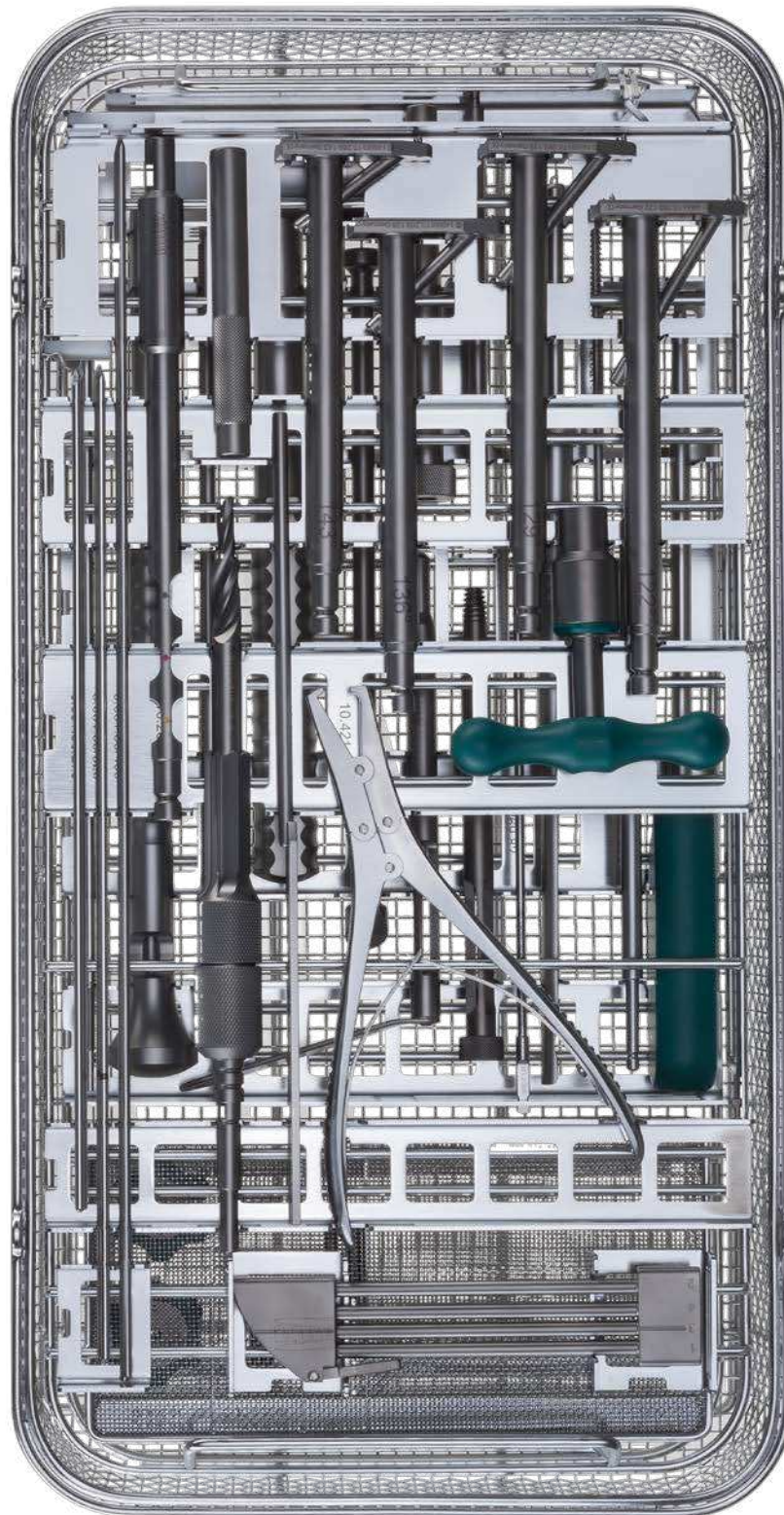

Set no. 19.608.00  Internal hexagon

RoSA® Trochanter stabilization plate 4.5 mm







variable angle-stable; titanium



Item no. 7.305.04



Item no. 7.304.04

Item no.	Item description	EAN
RoSA® Trochanter stabilization plate for screws 4.5; variable angle-stable; titanium		
7.304.00	RoSA® trochanter stabilization plate for screws 4.5; 2 head holes; neck 0 mm	 4 047075 167456
7.304.04	RoSA® trochanter stabilization plate for screws 4.5; 2 head holes; neck 4 mm	 4 047075 167463
7.304.08	RoSA® trochanter stabilization plate for screws 4.5; 2 head holes; neck 8 mm	 4 047075 167470
7.305.00	RoSA® trochanter stabilization plate for screws 4.5; 4 head holes; neck 0 mm	 4 047075 167487
7.305.04	RoSA® trochanter stabilization plate for screws 4.5; 4 head holes; neck 4 mm	 4 047075 167494
7.305.08	RoSA® trochanter stabilization plate for screws 4.5; 4 head holes; neck 8 mm	 4 047075 167500

RoSA® Trochanter stabilization plate 4.5 mm

variable angle-stable, titanium; set no. 19.612.00



Item no. 7.305.04



guide block; 4 holes; Item no. 10.269.924



Item no. 7.304.04



guide block; 2 holes; Item no. 10.269.922



set no. 19.612.00  Internal hexagon

Item no.	Item description	Quant.
Implants – plates		
RoSA® Trochanter stabilization plate for screws 4.5; titanium; vas		
7.304.00	length 64 mm; neck 0 mm; 2 head holes	1
7.304.04	length 68 mm; neck 4 mm; 2 head holes	1
RoSA® Trochanter stabilization plate for screws 4.5; titanium; vas		
7.305.00	length 109 mm; neck 0 mm; 4 head holes	1
7.305.04	length 113 mm; neck 4 mm; 4 head holes	1

Instruments		
10.269.93	fixation screw for RoSA®-trochanter stabilization plate; hex 3.5 mm	2
10.269.922	guide block for RoSA®-trochanter stabilization plate 2 holes	1
10.269.924	guide block for RoSA®-trochanter stabilization plate 4 holes	1
10.173.05	screw driver for guide block	1
2.9406.25	hex screwdriver with handle for screws Ø 2.7 mm - Ø 4.0 mm; AF 2.5 mm; conical	1
10.269.94	drill guide for variable angle stable screwing for drill Ø 3.2 mm for RoSA®	1
10.269.90	bending fixture for RoSA®-trochanter stabilization plate	1
10.269.91	bending lever for RoSA-trochanter stabilization plate	1

Item no.	Item description	Quant.
Implants - screws		
Cortical screw with conical head thread; Ø 4.5 mm; fully threaded; self tapping; titanium		
		
3.545.56	length 56 mm	4
3.545.60	length 60 mm	4
3.545.65	length 65 mm	4
3.545.70	length 70 mm	4
3.545.75	length 75 mm	4
3.545.80	length 80 mm	4
3.545.85	length 85 mm	4
3.545.90	length 90 mm	4

Container		
19.611.00	perforated autoclavicle container with inset for instruments/implants RoSA® trochanter stabilizing plate	1

RoSA® Trochanter stabilization plate 4.5 mm

variable angle-stable, titanium; set no. 19.612.00



set no. 19.612.00  Internal hexagon



set no. 19.612.00; lower level  Internal hexagon

RoSA® Implant removal

Set no. 19.610.00

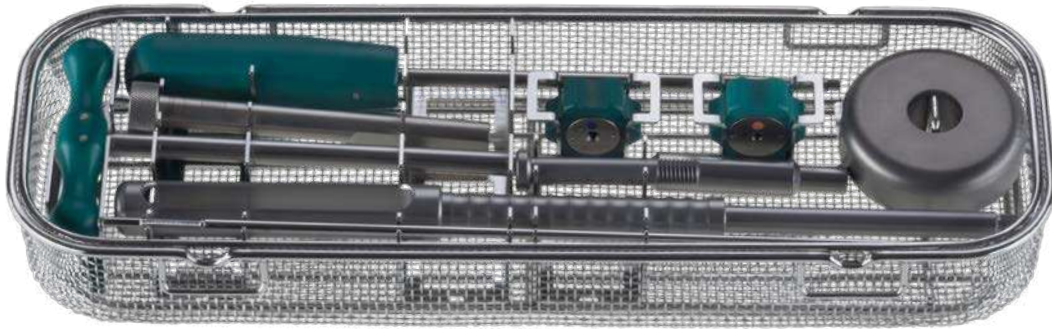

Set no. 19.610.00  Internal hexagon

Item no.	Item description	Quant.
Instruments		
2.9406.35/260	hex screwdriver with handle for screws Ø 4.5 mm - Ø 7.0 mm, AF 3.5 mm, length 260 mm	1
10.269.80	holding sleeve Ø 12 x 130 mm for RoSA®-connecting screw	1
10.269.63	Extraction rod for RoSA®-blade	1
10.269.631	Mass for extraction rod for RoSA®-blade	1
10.269.632	Screw hex 3.5 mm for mass for extraction rod RoSA®-blade	1
10.269.41	Screwdriver with T-handle for removal RoSA®-screw	1
10.269.50	threaded rod M4 x 305.5 mm for RoSA®, stainless steel	1
10.269.51	screwing aid for rod M4 for RoSA®	1
10.269.72	compression nut, M4 for RoSA®	1

Item no.	Item description	Quant.
Container		
19.609.00	perforated autoclavable container with inset for implant removal RoSA®	1

RoSA® Implant removal

Set no. 19.610.00

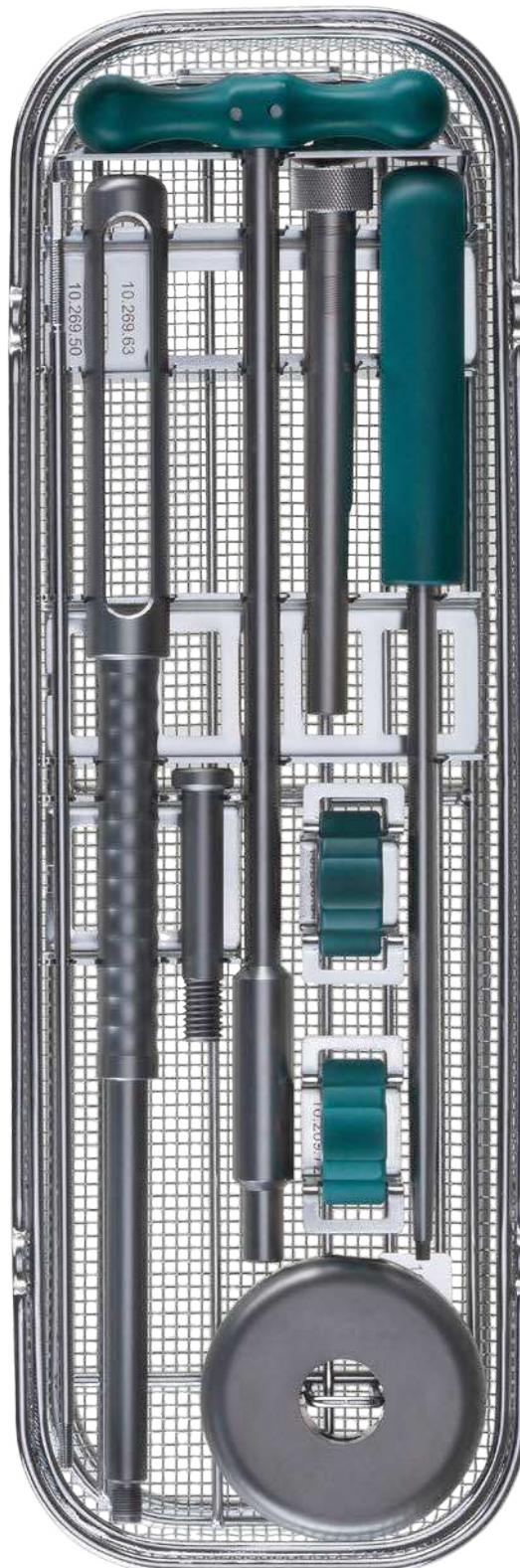

Set no. 19.610.00  Internal hexagon

DHS Flange

Stainless Steel

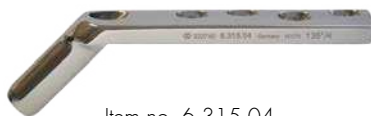

Item no. 6.315.04

Item no.	Item description
----------	------------------

Flange for dynamic condylar screw 125°; 130°

6.313.03	flange for dynamic hip screw 125°; 3 holes; 74 x 19 mm; stainless steel
6.314.02	flange for dynamic hip screw 130°; 2 holes; 58 x 19 mm; stainless steel
6.314.03	flange for dynamic hip screw 130°; 3 holes; 74 x 19 mm; stainless steel
6.314.04	flange for dynamic hip screw 130°; 4 holes; 90 x 19 mm; stainless steel
6.314.05	flange for dynamic hip screw 130°; 5 holes; 106 x 19 mm; stainless steel

available on request

6.314.06	flange for dynamic hip screw 130°; 6 holes; 122 x 19 mm; stainless steel
6.314.07	flange for dynamic hip screw 130°; 7 holes; 138 x 19 mm; stainless steel
6.314.08	flange for dynamic hip screw 130°; 8 holes; 154 x 19 mm; stainless steel
6.314.10	flange for dynamic hip screw 130°; 10 holes; 186 x 19 mm; stainless steel

Flange for dynamic hip screw 135°

6.315.02	flange for dynamic hip screw 135°; 2 holes; 58 x 19 mm; stainless steel
6.315.03	flange for dynamic hip screw 135°; 3 holes; 74 x 19 mm; stainless steel
6.315.04	flange for dynamic hip screw 135°; 4 holes; 90 x 19 mm; stainless steel
6.315.05	flange for dynamic hip screw 135°; 5 holes; 106 x 19 mm; stainless steel
6.315.06	flange for dynamic hip screw 135°; 6 holes; 122 x 19 mm; stainless steel
6.315.07	flange for dynamic hip screw 135°; 7 holes; 138 x 19 mm; stainless steel
6.315.08	flange for dynamic hip screw 135°; 8 holes; 154 x 19 mm; stainless steel
6.315.10	flange for dynamic hip screw 135°; 10 holes; 186 x 19 mm; stainless steel
6.315.12	flange for dynamic hip screw 135°; 12 holes; 218 x 19 mm; stainless steel
6.315.14	flange for dynamic hip screw 135°; 14 holes; 250 x 19 mm; stainless steel

available on request

6.315.09	flange for dynamic hip screw 135°; 9 holes; 170 x 19 mm; stainless steel
----------	--

DHS Flange

Stainless Steel

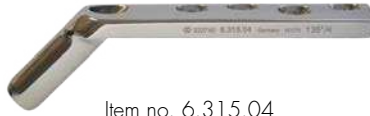

Item no. 6.315.04

Item no.	Item description
----------	------------------

Flange for dynamic hip screw 140°

6.316.02	flange for dynamic hip screw 140°; 2 holes; 58 x 19 mm; stainless steel
6.316.04	flange for dynamic hip screw 140°; 4 holes; 90 x 19 mm; stainless steel
6.316.05	flange for dynamic hip screw 140°; 5 holes; 106 x 19 mm; stainless steel

available on request

6.316.03	flange for dynamic hip screw 140°; 3 holes; 74 x 19 mm; stainless steel
----------	---

Flange for dynamic hip screw 145°

6.317.02	flange for dynamic hip screw 145°; 2 holes; 58 x 19 mm; stainless steel
6.317.04	flange for dynamic hip screw 145°; 4 holes; 90 x 19 mm; stainless steel

Flange for dynamic hip screw 150°

6.318.02	flange for dynamic hip screw 150°; 2 holes; 58 x 19 mm; stainless steel
6.318.04	flange for dynamic hip screw 150°; 4 holes; 90 x 19 mm; stainless steel
6.318.05	flange for dynamic hip screw 150°; 5 holes; 106 x 19 mm; stainless steel
6.318.06	flange for dynamic hip screw 150°; 6 holes; 122 x 19 mm; stainless steel

available on request

6.319.02	flange for dynamic hip screw 135°; 2 holes; 58 x 19 mm; cylinder 25; stainless steel
6.319.04	flange for dynamic hip screw 135°; 4 holes; 90 x 19 mm; cylinder 25; stainless steel
6.319.05	flange for dynamic hip screw 135°; 5 holes; 106 x 19 mm; cylinder 25; stainless steel
6.319.06	flange for dynamic hip screw 135°; 6 holes; 122 x 19 mm; cylinder 25; stainless steel
6.319.08	flange for dynamic hip screw 135°; 8 holes; 154 x 19 mm; cylinder 25; stainless steel
6.319.10	flange for dynamic hip screw 135°; 10 holes; 186 x 19 mm; cylinder 25; stainless steel

DCS Flange

Stainless Steel



Item no. 6.321.09

Item no.	Item description
----------	------------------

Flange for dynamic condylar screw

6.321.06	flange for dynamic condylar screw; 6 holes; 111 x 17 mm; stainless steel
6.321.07	flange for dynamic condylar screw; 7 holes; 127 x 17 mm; stainless steel
6.321.08	flange for dynamic condylar screw; 8 holes; 143 x 17 mm; stainless steel
6.321.09	flange for dynamic condylar screw; 9 holes; 159 x 17 mm; stainless steel
6.321.10	flange for dynamic condylar screw; 10 holes; 175 x 17 mm; stainless steel
6.321.12	flange for dynamic condylar screw; 12 holes; 207 x 17 mm; stainless steel
6.321.14	flange for dynamic condylar screw; 14 holes; 239 x 17 mm; stainless steel
6.321.16	flange for dynamic condylar screw; 16 holes; 271 x 17 mm; stainless steel

available on request

6.321.18	flange for dynamic condylar screw; 18 holes; 303 x 17 mm; stainless steel
----------	---

Set DHS/DCS Implants

Stainless Steel; Set no. 19.121.00



Item no. 6.395.00

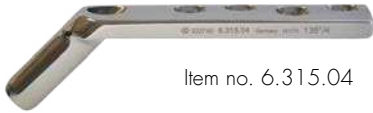

Item no. 6.315.04



Item no. 6.310.85

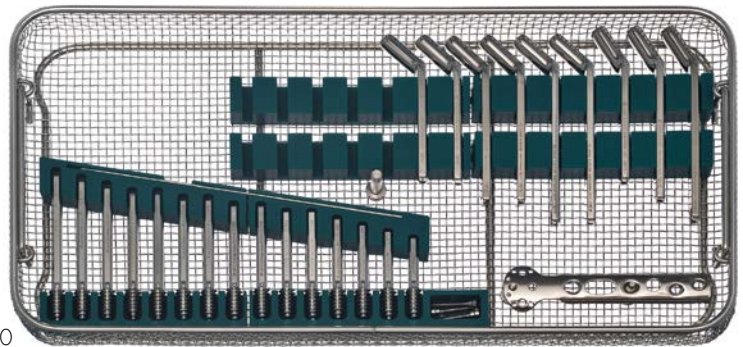

Item no. 19.121.00

Item no.	Item description	Quant.
Implants		
Dynamic hip and condylar screw Ø 12.5 mm; stainless steel		
6.310.65	length 65 mm	1
6.310.70	length 70 mm	1
6.310.75	length 75 mm	1
6.310.80	length 80 mm	1
6.310.85	length 85 mm	2
6.310.90	length 90 mm	2
6.310.95	length 95 mm	2
6.310.100	length 100 mm	2
6.310.105	length 105 mm	1
6.310.110	length 110 mm	1
6.310.115	length 115 mm	1

Flange for dynamic hip screw; stainless steel		
6.315.04	135°; 4 holes; 90 x 19 mm	2
6.315.05	135°; 5 holes; 106 x 19 mm	2
6.315.06	135°; 6 holes; 122 x 19 mm	2
6.318.04	150°; 4 holes; 90 x 19 mm	1
6.318.05	150°; 5 holes; 106 x 19 mm	1
6.318.06	150°; 6 holes; 122 x 19 mm	1

Item no.	Item description	Quant.
Implants		
Support plate 3.5/4.5		
6.395.00	6 holes; 148 x 22.5 mm; stainless steel	1

Compression screw for DHS		
6.311.01	length 35 mm; thread 27.5; M 4; wrench width 3.5; stainless steel	3

Guide wire		
2.983.25	Ø 2.5 x 230 mm; thread 10; stainless steel	5

Container		
19.124.00	perforated autoclavable container with inset for DHS-implants	1

Set DHS/DCS Implants

Stainless Steel; Set no. 19.121.00

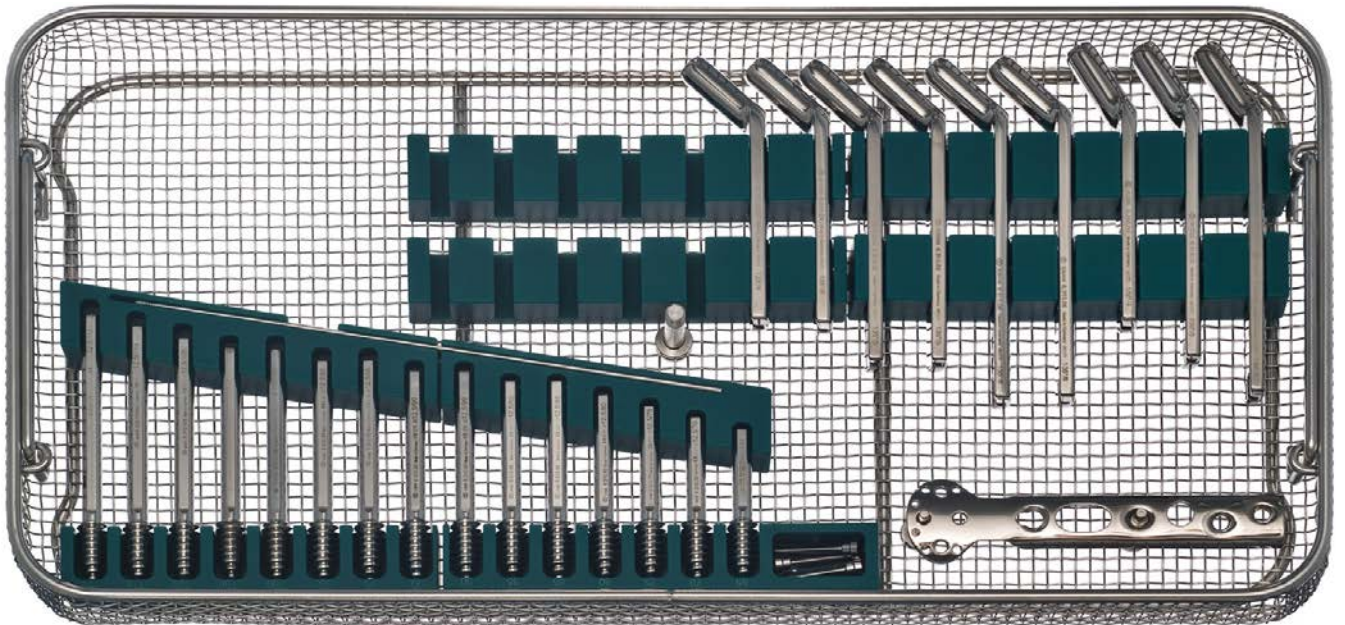

Item no. 19.121.00

DHS/DCS Screws

Stainless Steel



Item no. 6.310.85

Item no. Item description

Dynamic hip and condylar screw

6.310.60	dynamic hip and condylar screw; Ø 12.5 x 60 mm; stainless steel
6.310.65	dynamic hip and condylar screw; Ø 12.5 x 65 mm; stainless steel
6.310.70	dynamic hip and condylar screw; Ø 12.5 x 70 mm; stainless steel
6.310.75	dynamic hip and condylar screw; Ø 12.5 x 75 mm; stainless steel
6.310.80	dynamic hip and condylar screw; Ø 12.5 x 80 mm; stainless steel
6.310.85	dynamic hip and condylar screw; Ø 12.5 x 60 mm; stainless steel
6.310.90	dynamic hip and condylar screw; Ø 12.5 x 65 mm; stainless steel
6.310.95	dynamic hip and condylar screw; Ø 12.5 x 70 mm; stainless steel
6.310.100	dynamic hip and condylar screw; Ø 12.5 x 75 mm; stainless steel
6.310.105	dynamic hip and condylar screw; Ø 12.5 x 80 mm; stainless steel
6.310.110	dynamic hip and condylar screw; Ø 12.5 x 85 mm; stainless steel
6.310.115	dynamic hip and condylar screw; Ø 12.5 x 90 mm; stainless steel
6.310.120	dynamic hip and condylar screw; Ø 12.5 x 95 mm; stainless steel
6.310.125	dynamic hip and condylar screw; Ø 12.5 x 100 mm; stainless steel
6.310.130	dynamic hip and condylar screw; Ø 12.5 x 105 mm; stainless steel

available on request

6.310.50	dynamic hip and condylar screw; Ø 12.5 x 50 mm; stainless steel
6.310.55	dynamic hip and condylar screw; Ø 12.5 x 55 mm; stainless steel
6.310.135	dynamic hip and condylar screw; Ø 12.5 x 135 mm; stainless steel
6.310.140	dynamic hip and condylar screw; Ø 12.5 x 140 mm; stainless steel
6.310.145	dynamic hip and condylar screw; Ø 12.5 x 145 mm; stainless steel

Set DHS/DCS Instruments

Set no. 19.120.00



Item no. 19.120.00

Item no.	Item description	Quant.
Instruments		
2.904.08	drill bit for quick coupling; Ø 3.2 x 145 mm; spiral length 60 mm; double spiral	1
2.904.12	drill bit for quick coupling; Ø 4.5 x 145 mm; spiral length 60 mm; double spiral	1
2.925.45	tap for quick coupling for cortical screws; Ø 4.5 x 130 mm; thread 70	1
2.927.65	tap for quick coupling for cancellous screws; Ø 6.5 x 170 mm	1
10.315.05	tap for hip and condylar screws	1
10.305.05	T-handle with quick coupling; length 93.5 mm	1
10.300.01	T-handle with quick coupling for DHS; big	1
10.500.21	drill guide for neutral and compression position; Ø 3.2 mm	1
10.500.05	double drill guide; Ø 3.2 mm/ Ø 6.5 mm	1
10.502.45	universal drill guide; Ø 4.5 mm	1
2.940.35	hex screwdriver with handle for screws Ø 4.5 mm until Ø 7.0 mm; length 215 mm; wrench width 3.5	1
2.941.35	hex screwdriver inset for quick coupling for screw Ø 4.5 mm until Ø 7.0 mm; wrench width 3.5	1
2.953.45	gauge with clasp for screws Ø 4.5 mm and Ø 6.5 mm; measuring range 115	1
10.100.01	gauge for DHS/DCS	1
2.954.01	screw forceps; self holding	1
10.310.01	wrench for insertion and extraction of hip and condylar screws	1
10.350.02	connecting screw; length 245 mm; long; st. steel	1
10.350.01	connecting screw; length 145 mm; short; st. steel	1
10.320.01	three-level step drill for dynamic hip screws; complete	1
10.330.01	impactor for dynamic hip and condylar screws	1
10.340.01	guide sleeve; short	1
10.340.02	guide sleeve; long	1
10.325.02	cutter for dynamic condylar screws	1
10.152.01	universal targeting device for dynamic hip screws	1
10.310.02	guiding shank	1

Item no.	Item description	Quant.
Container		
19.123.00	perforated autoclavable container with inset for DHS-instruments	1

Set DHS/DCS Instruments

Set no. 19.120.00



Item no. 19.120.00

Set Screw Container for DHS

titanium; Set no. 19.168.30



Item no. 3.152.30



Item no. 3.170.70



Item no. 3.180.70



Set no. 19.168.30 *  internal hexagon

Item no.	Item description	Quant.
Implants – screws		
Cortical screw Ø 4.5 mm; fully threaded; self tapping; titanium		
3.152.20	length 20 mm	3
3.152.22	length 22 mm	3
3.152.24	length 24 mm	3
3.152.26	length 26 mm	3
3.152.28	length 28 mm	3
3.152.30	length 30 mm	3
3.152.32	length 32 mm	3
3.152.34	length 34 mm	3
3.152.36	length 36 mm	3
3.152.38	length 38 mm	3
3.152.40	length 40 mm	3
3.152.42	length 42 mm	3
3.152.44	length 44 mm	3
3.152.46	length 46 mm	3
3.152.48	length 48 mm	3
3.152.50	length 50 mm	2
3.152.52	length 52 mm	2
3.152.54	length 54 mm	2
3.152.56	length 56 mm	2
3.152.58	length 58 mm	2
3.152.60	length 60 mm	2

Item no.	Item description	Quant.
Implants – screws		
Cancellous screw Ø 6.5 mm; thread 16; titanium		
3.170.45	length 45 mm	2
3.170.50	length 50 mm	2
3.170.55	length 55 mm	2
3.170.60	length 60 mm	2
3.170.65	length 65 mm	2
3.170.70	length 70 mm	2
3.170.75	length 75 mm	2
3.170.80	length 80 mm	2
3.170.85	length 85 mm	2
3.170.90	length 90 mm	2
3.170.95	length 95 mm	2
3.170.100	length 100 mm	2
3.170.105	length 105 mm	2
3.170.110	length 110 mm	2

Set Screw Container for DHS

titanium; Set no. 19.168.30

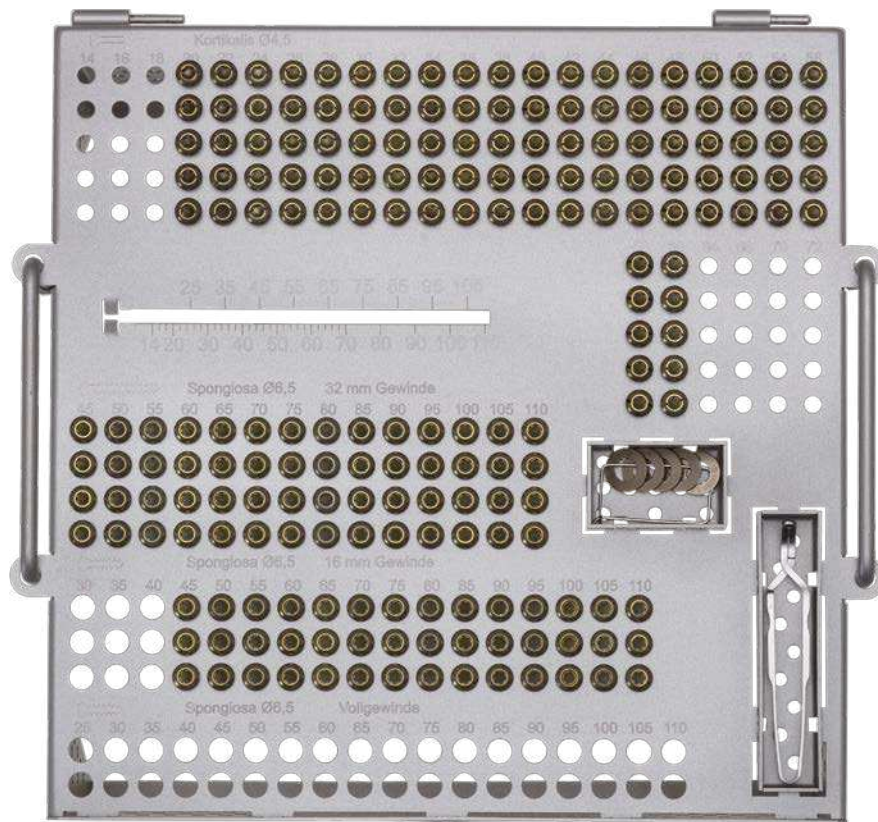

Set no. 19.168.30 *  internal hexagon

Item no.	Item description	Quant.
Implants – screws		
Cancellous screw Ø 6.5 mm; thread 32; titanium		
3.180.45	length 45 mm	2
3.180.50	length 50 mm	2
3.180.55	length 55 mm	2
3.180.60	length 60 mm	2
3.180.65	length 65 mm	2
3.180.70	length 70 mm	2
3.180.75	length 75 mm	2
3.180.80	length 80 mm	2
3.180.85	length 85 mm	2
3.180.90	length 90 mm	2
3.180.95	length 95 mm	2
3.180.100	length 100 mm	2
3.180.105	length 105 mm	2
3.180.110	length 110 mm	2

Item no.	Item description	Quant.
Instruments		
2.954.01	screw forceps, self holding	1
20.502.00	holding clamp, big	1

Implants – washers		
3.200.03	washer, outside Ø 13 mm / inside Ø 6.7 mm, titanium	3

Container		
19.168.00	screw container for large fragment; empty	1

* Example illustration can show different number of screws.

Set Screw container for DHS

stainless steel; set no. 19.168.10



Item no. 2.152.30



Item no. 2.170.50



Item no. 2.180.50

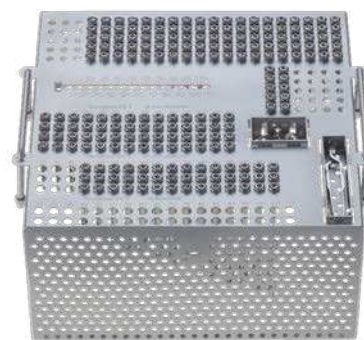

Set no. 19.168.10 *  Internal hexagon

Item no.	Item description	Quant.
Implants – screws		
Cortical screw Ø 4.5 mm; fully threaded; self tapping; stainless steel		
2.152.20	length 20 mm	3
2.152.22	length 22 mm	3
2.152.24	length 24 mm	3
2.152.26	length 26 mm	3
2.152.28	length 28 mm	3
2.152.30	length 30 mm	3
2.152.32	length 32 mm	3
2.152.34	length 34 mm	3
2.152.36	length 36 mm	3
2.152.38	length 38 mm	3
2.152.40	length 40 mm	3
2.152.42	length 42 mm	3
2.152.44	length 44 mm	3
2.152.46	length 46 mm	3
2.152.48	length 48 mm	3
2.152.50	length 50 mm	2
2.152.52	length 52 mm	2
2.152.54	length 54 mm	2
2.152.56	length 56 mm	2
2.152.58	length 58 mm	2
2.152.60	length 60 mm	2

Item no.	Item description	Quant.
Implants – screws		
Cancellous screw Ø 6.5 mm; thread 16; stainless steel		
2.170.45	length 45 mm	2
2.170.50	length 50 mm	2
2.170.55	length 55 mm	2
2.170.60	length 60 mm	2
2.170.65	length 65 mm	2
2.170.70	length 70 mm	2
2.170.75	length 75 mm	2
2.170.80	length 80 mm	2
2.170.85	length 85 mm	2
2.170.90	length 90 mm	2
2.170.95	length 95 mm	2
2.170.100	length 100 mm	2
2.170.105	length 105 mm	2
2.170.110	length 110 mm	2

Set Screw container for DHS

stainless steel; set no. 19.168.10

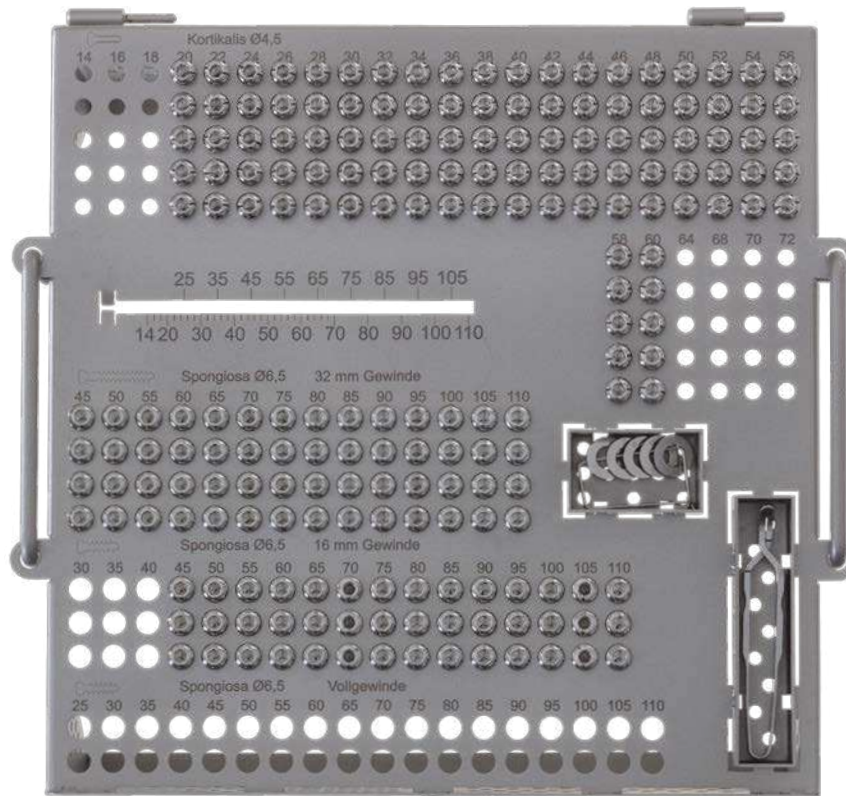

Set no. 19.168.10 *  Internal hexagon

Item no.	Item description	Quant.
Implants – screws		
Cancellous screw Ø 6.5 mm; thread 32; stainless steel		
2.180.45	length 45 mm	2
2.180.50	length 50 mm	2
2.180.55	length 55 mm	2
2.180.60	length 60 mm	2
2.180.65	length 65 mm	2
2.180.70	length 70 mm	2
2.180.75	length 75 mm	2
2.180.80	length 80 mm	2
2.180.85	length 85 mm	2
2.180.90	length 90 mm	2
2.180.95	length 95 mm	2
2.180.100	length 100 mm	2
2.180.105	length 105 mm	2
2.180.110	length 110 mm	2

Item no.	Item description	Quant.
Instruments		
2.954.01	screw forceps; self holding	1
20.502.00	holding clamp; big	1

Implants – washers		
2.200.03	washer; outside Ø 13 mm / inside Ø 6.7 mm; stainless steel	3

Container		
19.168.00	screw container for large fragment; empty	1

* Example illustration can show different number of screws.

KFN-Königsee Femoral Nail

Titanium



Item no.	Item description	EAN
----------	------------------	-----

Implants - Nails

Königsee Femoral Nail 125°; titanium

7.3KF.10/210	Königsee Femoral Nail 125°; Ø 10 x 210 mm; cannulated; inside Ø 4.7 mm	4 047075 131723
7.3KF.11/210	Königsee Femoral Nail 125°; Ø 11 x 210 mm; cannulated; inside Ø 4.7 mm	4 047075 131730
7.3KF.12/210	Königsee Femoral Nail 125°; Ø 12 x 210 mm; cannulated; inside Ø 4.7 mm	4 047075 131747
7.3KF.13/210	Königsee Femoral Nail 125°; Ø 13 x 210 mm; cannulated; inside Ø 4.7 mm	4 047075 131754
7.3KF10,5L/340	Königsee Femoral Nail 125°; Ø 10.5 x 340 mm; cannulated; inside Ø 4.7 mm; left	4 047075 142439
7.3KF10,5R/340	Königsee Femoral Nail 125°; Ø 10.5 x 340 mm; cannulated; inside Ø 4.7 mm; right	4 047075 142453
7.3KF10,5L/380	Königsee Femoral Nail 125°; Ø 10.5 x 380 mm; cannulated; inside Ø 4.7 mm; left	4 047075 142446
7.3KF10,5R/380	Königsee Femoral Nail 125°; Ø 10.5 x 380 mm; cannulated; inside Ø 4.7 mm; right	4 047075 142460

Königsee Femoral Nail 130°; titanium

7.1KF.10/210	Königsee Femoral Nail 130°; Ø 10 x 210 mm; cannulated; inside Ø 4.7 mm	4 047075 129140
7.1KF.11/210	Königsee Femoral Nail 130°; Ø 11 x 210 mm; cannulated; inside Ø 4.7 mm	4 047075 129157
7.1KF.12/210	Königsee Femoral Nail 130°; Ø 12 x 210 mm; cannulated; inside Ø 4.7 mm	4 047075 129164
7.1KF.13/210	Königsee Femoral Nail 130°; Ø 13 x 210 mm; cannulated; inside Ø 4.7 mm	4 047075 135165
7.1KF10,5L/340	Königsee Femoral Nail 130°; Ø 10.5 x 340 mm; cannulated; inside Ø 4.7 mm; left	4 047075 129171
7.1KF10,5R/340	Königsee Femoral Nail 130°; Ø 10.5 x 340 mm; cannulated; inside Ø 4.7 mm; right	4 047075 129195
7.1KF10,5L/420	Königsee Femoral Nail 130°; Ø 10.5 x 420 mm; cannulated; inside Ø 4.7 mm; left	4 047075 129188
7.1KF10,5R/420	Königsee Femoral Nail 130°; Ø 10.5 x 420 mm; cannulated; inside Ø 4.7 mm; right	4 047075 129201

Implants - Screws; titanium alloy; TiOB®-coated; bioinert

3.157.25	interlocking screw for KFN; Ø 5.5 x 25 mm; self tapping	4 047075 093199
3.157.26	interlocking screw for KFN; Ø 5.5 x 26 mm; self tapping	4 047075 049530
3.157.28	interlocking screw for KFN; Ø 5.5 x 28 mm; self tapping	4 047075 062454
3.157.30	interlocking screw for KFN; Ø 5.5 x 30 mm; self tapping	4 047075 093083
3.157.32	interlocking screw for KFN; Ø 5.5 x 32 mm; self tapping	4 047075 093090



Königsee Implantate GmbH
OT Aschau | Am Sand 4
07426 Allendorf | Germany

Fon +49 36738 498-560
Fax +49 36738 498-569

Mail export@koenigsee-implantate.de

For further information please visit:
www.koenigsee-implantate.com

HeBo | Edition 02 | 2020-02
All pictured products are CE compliant.

KFN-Königsee Femoral Nail

Titanium



Item no.	Item description	EAN
----------	------------------	-----

Implants - Screws; titanium alloy; TiOB[®]-coated; bioinert

3.157.34	interlocking screw for KFN; Ø 5.5 x 34 mm; self tapping	4 047075 093106
3.157.35	interlocking screw for KFN; Ø 5.5 x 35 mm; self tapping	4 047075 093113
3.157.36	interlocking screw for KFN; Ø 5.5 x 36 mm; self tapping	4 047075 093120
3.157.38	interlocking screw for KFN; Ø 5.5 x 38 mm; self tapping	4 047075 093014
3.157.40	interlocking screw for KFN; Ø 5.5 x 40 mm; self tapping	4 047075 093021
3.157.42	interlocking screw for KFN; Ø 5.5 x 42 mm; self tapping	4 047075 093144
3.157.44	interlocking screw for KFN; Ø 5.5 x 44 mm; self tapping	4 047075 093045
3.157.45	interlocking screw for KFN; Ø 5.5 x 45 mm; self tapping	4 047075 093052
3.157.50	interlocking screw for KFN; Ø 5.5 x 50 mm; self tapping	4 047075 148523
3.157.55	interlocking screw for KFN; Ø 5.5 x 55 mm; self tapping	4 047075 148530
3.157.60	interlocking screw for KFN; Ø 5.5 x 60 mm; self tapping	4 047075 148547
3.157.65	interlocking screw for KFN; Ø 5.5 x 65 mm; self tapping	4 047075 148554
3.428.65	anti-rotation screw for KFN; Ø 6.0 x 65 mm	4 047075 121021
3.428.70	anti-rotation screw for KFN; Ø 6.0 x 70 mm	4 047075 121038
3.428.75	anti-rotation screw for KFN; Ø 6.0 x 75 mm	4 047075 097029
3.428.80	anti-rotation screw for KFN; Ø 6.0 x 80 mm	4 047075 097036
3.428.85	anti-rotation screw for KFN; Ø 6.0 x 85 mm	4 047075 097180
3.428.90	anti-rotation screw for KFN; Ø 6.0 x 90 mm	4 047075 097197
3.428.95	anti-rotation screw for KFN; Ø 6.0 x 95 mm	4 047075 097050
3.428.100	anti-rotation screw for KFN; Ø 6.0 x 100 mm	4 047075 097135
3.428.105	anti-rotation screw for KFN; Ø 6.0 x 105 mm	4 047075 097142
3.428.110	anti-rotation screw for KFN; Ø 6.0 x 110 mm	4 047075 097159
3.428.115	anti-rotation screw for KFN; Ø 6.0 x 115 mm	4 047075 097005
3.428.120	anti-rotation screw for KFN; Ø 6.0 x 120 mm	4 047075 097012

KFN-Königsee Femoral Nail

Titanium



Item no.	Item description	EAN
----------	------------------	-----

Implants - Screws

7.311.12	locking screw without arresting bolt for KFN; length 28 mm; M 12; titanium alloy; TiOB [®] -coated; bioinert	4 047075 037025
7.311.30	locking screw with arresting bolt for KFN; length 30 mm; M 12; titanium alloy; TiOB [®] -coated; bioinert	4 047075 037315
7.311.01	compression screw for DHS; M 4 x 27 mm; length 35 mm; SW 3.5; titanium alloy	4 047075 037285
3.310.52	supporting screw sleeve for KFN; Ø 12 x 52 mm; titanium alloy; TiOB [®] -coated; bioinert	4 047075 095247

Implants - Screws; titanium alloy; TiOB[®]-coated; bioinert

7.313.70	supporting screw for KFN; Ø 10 x 70 mm	4 047075 121168
7.313.75	supporting screw for KFN; Ø 10 x 75 mm	4 047075 121175
7.313.80	supporting screw for KFN; Ø 10 x 80 mm	4 047075 121182
7.313.85	supporting screw for KFN; Ø 10 x 85 mm	4 047075 037179
7.313.90	supporting screw for KFN; Ø 10 x 90 mm	4 047075 037353
7.313.95	supporting screw for KFN; Ø 10 x 95 mm	4 047075 037360
7.313.100	supporting screw for KFN; Ø 10 x 100 mm	4 047075 037100
7.313.105	supporting screw for KFN; Ø 10 x 105 mm	4 047075 037117
7.313.110	supporting screw for KFN; Ø 10 x 110 mm	4 047075 037124
7.313.115	supporting screw for KFN; Ø 10 x 115 mm	4 047075 037131
7.313.120	supporting screw for KFN; Ø 10 x 120 mm	4 047075 037148
7.313.125	supporting screw for KFN; Ø 10 x 125 mm	4 047075 037155
7.313.130	supporting screw for KFN; Ø 10 x 130 mm	4 047075 037162

TiOB[®] is a trademark of Königsee Implantate GmbH registered in the EU countries, Switzerland and the USA.

It is a surface coating that brings optimized properties.



Königsee Implantate GmbH
OT Aschau | Am Sand 4
07426 Allendorf | Germany

Fon +49 36738 498-560
Fax +49 36738 498-569

Mail export@koenigsee-implantate.de

For further information please visit:
www.koenigsee-implantate.com

HeBo | Edition 02 | 2020-02
All pictured products are CE compliant.

Set KFN-Königsee Femoral Nail

Titanium; Set no. 19.344.00





Item no. 7.1KF.10/210 Item no. 7.1KF.11/210 Item no. 7.1KF.12/210

Container Implants; Set no. 19.345.00  Internal hexagon

Item no.	Item description	Quant.
Implants – KFN nails		
KFN-Königsee Femoral Nail 130°; titanium		
7.1KF.10/210	Ø10x210mm; cannulated; inside-Ø4.7 mm	1
7.1KF.11/210	Ø11x210mm; cannulated; inside-Ø4.7 mm	1
7.1KF.12/210	Ø12x210mm; cannulated; inside-Ø4.7 mm	1

Implants – screws		
Interlocking screw for KFN Ø 5.5 mm; self tapping; titanium alloy; TiOB®-coated; bioinert 		
3.157.26	length 26 mm	2
3.157.28	length 28 mm	2
3.157.30	length 30 mm	2
3.157.32	length 32 mm	2
3.157.34	length 34 mm	2
3.157.36	length 36 mm	2
3.157.38	length 38 mm	2
3.157.40	length 40 mm	2
3.157.42	length 42 mm	2
3.157.44	length 44 mm	2

Locking screw for KFN; titanium alloy; TiOB®-coated; bioinert 		
7.311.12	without arresting bolt ; length 28 mm; M 12	2
7.311.30	with arresting bolt; length 30 mm; M 12	2

Compression screw for KFN; titanium alloy 		
7.311.01	thread 27; M 4; L 35 mm; wrench width 3.5	2

Sleeve of support. screw; tit. alloy; TiOB®-coated; bioinert 		
3.310.52	supporting screw sleeve f. KFN; Ø 12 x 52 mm	2

Item no.	Item description	Quant.
Implants – screws		
Anti-rotation screw for KFN; Ø 6.0 mm; titanium alloy; TiOB®-coated; bioinert 		
3.428.75	length 75 mm	1
3.428.80	length 80 mm	1
3.428.85	length 85 mm	1
3.428.90	length 90 mm	1
3.428.95	length 95 mm	1
3.428.100	length 100 mm	1
3.428.105	length 105 mm	1
3.428.110	length 110 mm	1
3.428.115	length 115 mm	1
3.428.120	length 120 mm	1

Supporting screw for KFN; Ø 10 mm; titanium alloy; TiOB®-coated; bioinert 		
7.313.85	length 85 mm	1
7.313.90	length 90 mm	1
7.313.95	length 95 mm	1
7.313.100	length 100 mm	1
7.313.105	length 105 mm	1
7.313.110	length 110 mm	1
7.313.115	length 115 mm	1
7.313.120	length 120 mm	1
7.313.125	length 125 mm	1
7.313.130	length 130 mm	1

Container		
19.345.00	perforated autoclavable container with inset for implants KFN	1

Set KFN-Königsee Femoral Nail

Titanium; Set no. 19.344.00



Container1 Instruments; Set no. 19.347.00  Internal hexagon

Item no.	Item description	Quant.
Instruments – color code red		
10.264.19	intramedullary reamer; Ø 17 x 269 mm; cannulated; inside Ø 3.5 mm	1
10.264.20	tissue protecting drill sleeve for intramedullary reamer; Ø 20 x 107 mm; inside Ø 17.2 mm	1
10.264.21	sleeve for intramedullary reamer; Ø 17 mm/ Ø 3.2 x 121 mm	1
10.264.22	trocars for sleeve for intramedullary reamer; Ø 3.0 x 132 mm	1

Wire – color code red		
2.984.30/400	guide wire; Ø 3.0 x 400 mm; thread 10; stainless steel	5

Item no.	Item description	Quant.
Instruments – color code yellow		
10.264.01	screwdriver for insertion	1
10.264.02	fixation rod for screwdriver for insertion; Ø 4.0 x 336 mm	1
10.264.03	hex screwdriver with handle and holding sleeve; wrench width 3.5	1
10.264.04	gauge for supporting screw	1
10.264.05	sleeve for supporting screw; Ø 16 mm/ Ø 14 x 200 mm	1
10.264.06	sleeve for supporting screw; Ø 14 mm/ Ø 2.7 x 211 mm	1
10.264.07	trocars for sleeve for supporting screw; Ø 2.5 x 222 mm	1
10.264.08	step drill-set for supporting screw; complete	1
10.264.27	T-handle with quick coupling for KFN; cannulated; inside Ø 4.2 mm	1

Wire – color code yellow		
2.984.25/400	guide wire; Ø 2.5 x 400 mm; thread 10; stainless steel	5

Container		
19.347.00	perforated autoclavable container with inset for instruments 1 KFN	1

TiOB® is a trademark of Königsee Implantate GmbH registered in the EU countries, Switzerland and the USA.

It is a surface treatment that brings optimized properties.



Königsee Implantate GmbH
OT Aschau | Am Sand 4
07426 Allendorf | Germany

Fon +49 36738 498-560
Fax +49 36738 498-569

Mail export@koenigsee-implantate.de

For further information please visit:
www.koenigsee-implantate.com

HeBo | Edition 02 | 2020-02
All pictured products are CE compliant.

Set KFN-Königsee Femoral Nail

Titanium; Set no. 19.344.00

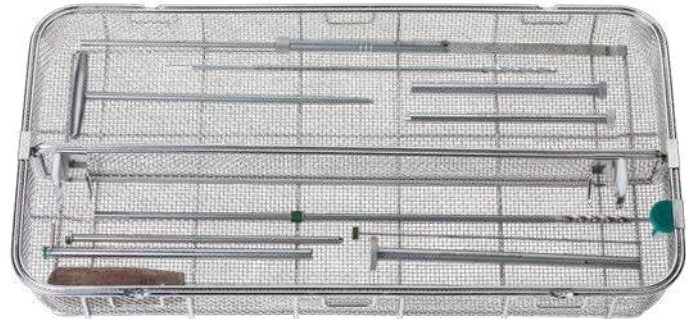

Container 2 Instruments; Set no. 19.348.00  Internal hexagon

Item no.	Item description	Quant.
Instruments – color code green		
10.264.12	sleeve for anti-rotation screw; Ø 8.8 mm/ Ø 6.7 x 198 mm	1
10.264.14	sleeve for anti-rotation screw; Ø 6.5 mm/ Ø 2.2 x 205 mm	1
10.264.15	trocár for sleeve for anti-rotation screw; Ø 2.0 x 215 mm	1
10.264.16	drill bit; Ø 6.0 x 400 mm; quadruple spiral; spiral length 55 mm; cannulated; inside Ø 2.2 mm	1
10.264.17	hex screwdriver with handle; cannulated; inside Ø 2.2 mm; wrench width 3.5 mm	1
10.264.18	unscrewable sleeve; Ø 10 x 200.5 mm	1

Wire – color code green		
2.984.20/400	guide wire; Ø 2.0 x 400 mm; thread 10; stainless steel	5

Item no.	Item description	Quant.
Instruments – color code silver		
10.261.011	drill guide; Ø 8.0 x 150 mm; indented; silver	1
10.261.031	drill guide; Ø 4.8 x 160 mm; silver	1
10.261.15	drill bit; Ø 4.8 x 305 mm; spiral length 60 mm	1
10.261.16	gauge with clasp; measuring range 110 mm	1
2.930.35	hex screwdriver with T-handle for screw Ø 4.5 mm until Ø 7.0 mm; length 232 mm	1
10.263.01	impactor and extractor for KFN	1

Container		
19.348.00	perforated autoclavable container with inset for instruments 2 KFN	1

TiOB® is a trademark of Königsee Implantate GmbH registered in the EU countries, Switzerland and the USA.

It is a surface treatment that brings optimized properties.



Königsee Implantate GmbH
OT Aschau | Am Sand 4
07426 Allendorf | Germany

Fon +49 36738 498-560
Fax +49 36738 498-569

Mail export@koenigsee-implantate.de

For further information please visit:
www.koenigsee-implantate.com

HeBo | Edition 02 | 2020-02
All pictured products are CE compliant.

Set KFN-Königsee Femoral Nail

Titanium; Set no. 19.344.00



Container 3 Instruments; Set no. 19.349.00  Internal hexagon

Item no.	Item description	Quant.
Instruments – guide frame system		
10.264.50	guide frame KFN	1
10.264.50/3	locking screw for guide frame KFN	1
10.264.51	cap for guide frame; distal; complete	1
10.264.52	cap for guide frame 130°; complete	1
10.264.55	cap for guide frame 125°; complete	1

Item no.	Item description	Quant.
Container		
19.349.00	perforated autoclavable container with inset for instruments 3 KFN	1

Instruments		
10.262.04	bent awl; big	1
10.263.05	open-end wrench with handle; wrench width 17	1
10.264.09	screwdriver for extraction with t-handle	1
10.264.10	fixation rod for screwdriver for extraction; Ø 4.0 x 270 mm	1
10.264.11A	adapter for impactor for guide frame	1
10.264.23	tissue protector	1
10.264.24	plastic hammer	1
10.264.29	hex screwdriver with T-handle; wrench width 8	1
10.264.30/3	locking screw for guide frame KFN	1

TiOB® is a trademark of Königsee Implantate GmbH registered in the EU countries, Switzerland and the USA.

It is a surface treatment that brings optimized properties.



Königsee Implantate GmbH
OT Aschau | Am Sand 4
07426 Allendorf | Germany

Fon +49 36738 498-560
Fax +49 36738 498-569

Mail export@koenigsee-implantate.de

For further information please visit:
www.koenigsee-implantate.com

HeBo | Edition 02 | 2020-02
All pictured products are CE compliant.

Set KFN-Königsee Femoral Nail

Titanium; Set no. 19.344.00

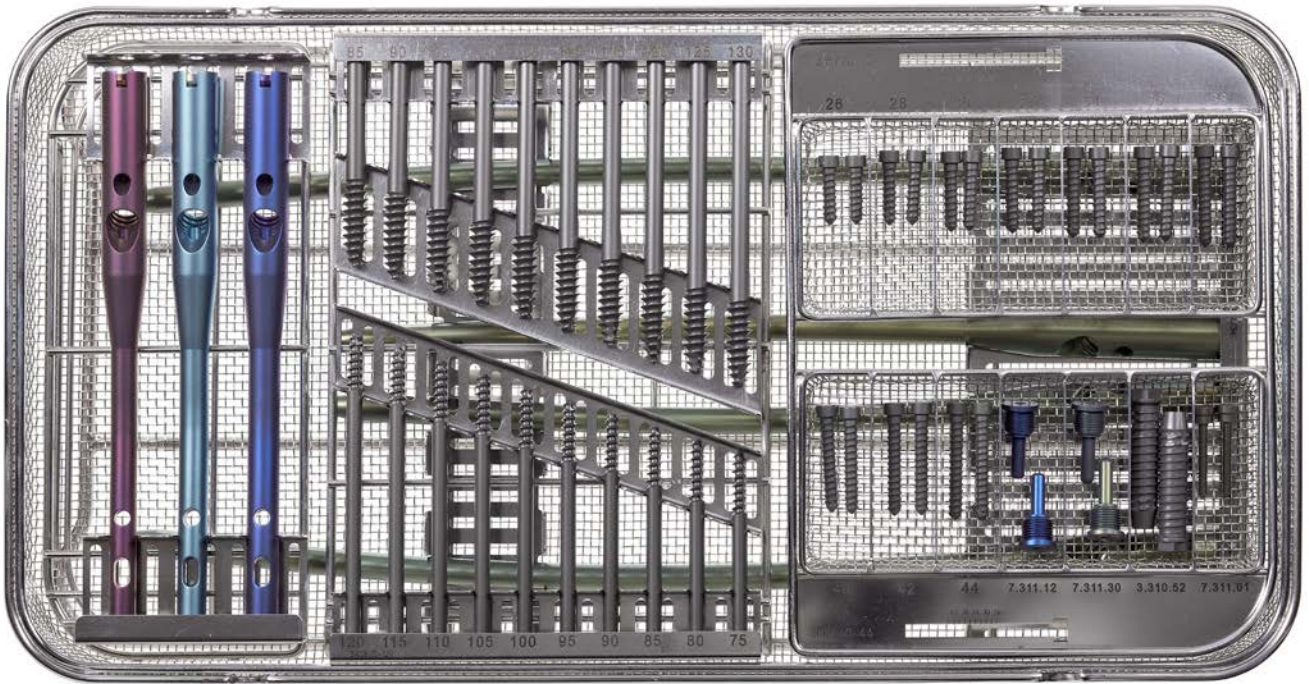

Container implants KFN; set no. 19.345.00  Internal hexagon

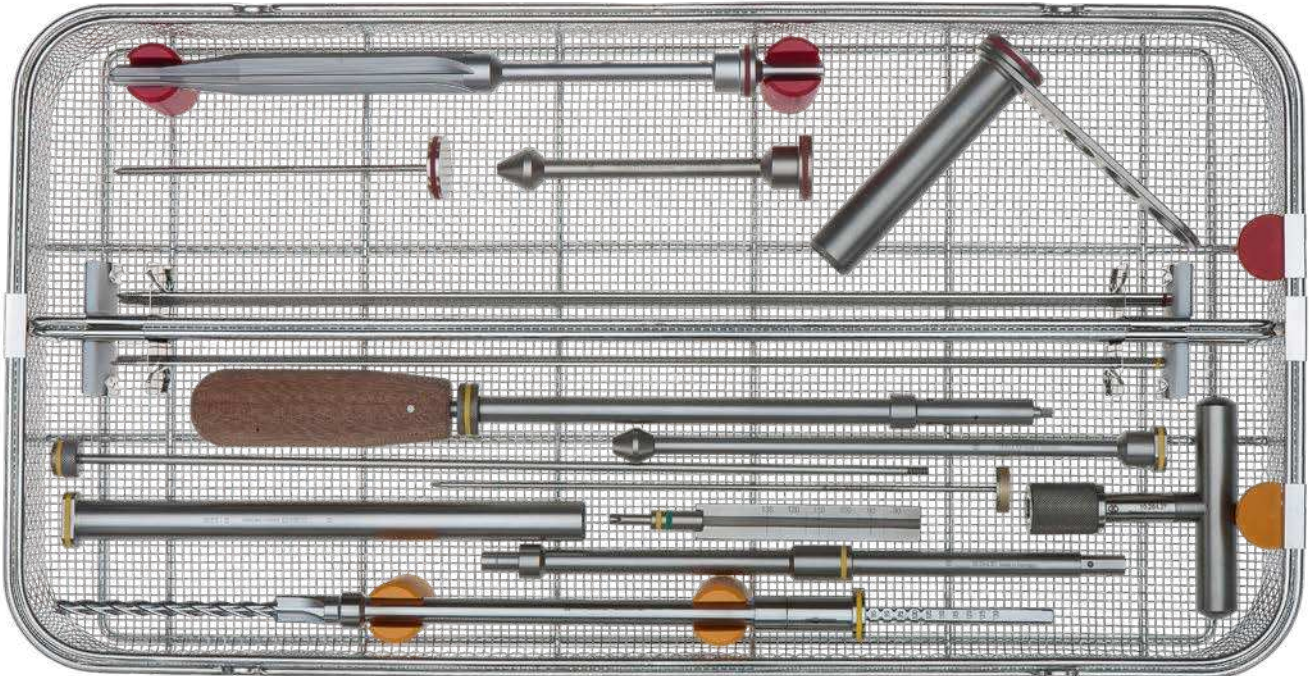

Container 1 instruments; set no. 19.347.00  Internal hexagon

Set KFN-Königsee Femoral Nail

Titanium; Set no. 19.344.00



Container 2 instruments; set no. 19.348.00  Internal hexagon



Container 3 instruments; set no. 19.349.00  Internal hexagon

Set Instruments KFN-Explantation

for explantation of KFN-Königsee Femoral Nail; Set no. 19.344.10



Set no. 19.344.10  Internal hexagon

Item no.	Item description	Quant.
Instruments		
2.930.35	hex screwdriver with T-handle for screw Ø 4.5 mm until Ø 7.0 mm, length 232 mm	1
10.263.01	impactor and extractor for KFN	1
10.263.05	open-end wrench with handle, wrench width 17	1
10.264.03	hex screwdriver with handle and holding sleeve, wrench width 3.5 mm	1
10.264.09	screwdriver for extraction with t-handle	1
10.264.10	fixation rod for screwdriver for extraction, Ø 4.0 mm x 270 mm	1
10.264.17	hex screwdriver with handle, cannulated, inside Ø 2.2 mm, wrench width 3.5 mm	1
10.264.18	unscrewable sleeve, Ø 10.0 mm x 200.5 mm	1
10.264.30/3	locking screw for guide frame KFN	1

Item no.	Item description	Quant.
Container		
19.347.00	perforated autoclavable container with inset for instruments 1 KFN	1

Angle-stable Distal Femur Plate

for Screws Ø 4.5/5.5 mm; Large Fragment; Titanium



Item no. 5.9462.06



Item no. 5.9482.12

Item no.	Item description
----------	------------------

Distal femur plate with conical thread Ø 4.5 mm to 6.0 mm; plate thickness 4.5 mm; titanium

5.9462.04	4 holes; 118 mm x 18 mm; right
5.9462.06	6 holes; 150 mm x 18 mm; right
5.9472.04	4 holes; 118 mm x 18 mm; left
5.9472.06	6 holes; 150 mm x 18 mm; left

Distal femur plate with conical thread Ø 4.5 mm to 6.0 mm; plate thickness 6.0 mm; titanium

5.9482.08	8 holes; 182 mm x 18 mm; right
5.9482.10	10 holes; 214 mm x 18 mm; right
5.9482.12	12 holes; 246 mm x 18 mm; right
5.9482.14	14 holes; 277 mm x 18 mm; right
5.9482.16	16 holes; 309 mm x 18 mm; right
5.9492.08	8 holes; 182 mm x 18 mm; left
5.9492.10	10 holes; 214 mm x 18 mm; left
5.9492.12	12 holes; 246 mm x 18 mm; left
5.9492.14	14 holes; 277 mm x 18 mm; left
5.9492.16	16 holes; 309 mm x 18 mm; left

Set Angle-stable Distal Femur Plate

for Screws Ø 4.5/5.5 mm; Large Fragment; Titanium; Set no. 19.602.00



Item no. 5.9482.12



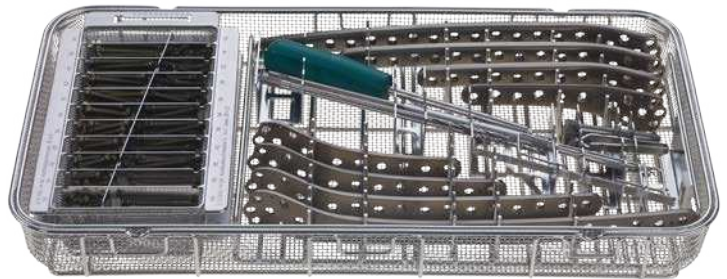

Item no. 9.946.05



Set no. 19.602.00  Internal hexagon

Item no.	Item description	Quant.
Implants - plates		
Distal femur plate with conical thread Ø 4.5 mm to 6.0 mm; plate thickness 4.5 mm; titanium		
5.9462.06	6 holes; 150 mm x 18 mm; right	1
5.9472.06	6 holes; 150 mm x 18 mm; left	1
Distal femur plate with conical thread Ø 4.5 mm to 6.0 mm; plate thickness 6.0 mm; titanium		
5.9482.08	8 holes; 182 mm x 18 mm; right	1
5.9482.12	12 holes; 246 mm x 18 mm; right	1
5.9482.16	16 holes; 309 mm x 18 mm; right	1
5.9492.08	8 holes; 182 mm x 18 mm; left	1
5.9492.12	12 holes; 246 mm x 18 mm; left	1
5.9492.16	16 holes; 309 mm x 18 mm; left	1
Instruments		
2.9406.35	hex screwdriver with handle for screws Ø 4.5 mm - Ø 7.0 mm; AF 3.5; length 215 mm; PPSU	1
2.977.02	drill guide for angle stable screwing; length 70 mm; large fragment	2
2.977.15	drill guide for angle stable screwing 5.5; length 70 mm	2
2.904.09	drill bit for quick coupling; Ø 3.2 mm x 195 mm; spiral length 60 mm; double spiral	1
2.904.23	drill bit for quick coupling; Ø 4.0 mm x 220 mm; spiral length 60 mm; double spiral	1
2.954.01	screw forceps; self holding	1
2.953.90	gauge with clasp for screws Ø 4.5 mm/Ø 6.0 mm; measuring range 90	1
Wire		
6.031.16	Kirschner wire with trocar point and round end; Ø 1.6 mm x 150 mm; stainless steel	5
Container		
19.601.00	perforated autoclavable container with inset for instruments and distal femur plates	1



Item no.	Item description	Quant.
Implants - screws		
Cortical screw with conical head thread Ø 4.5 mm; fully threaded self tapping; titanium 		
3.545.14	length 14 mm	6
3.545.18	length 18 mm	6
3.545.22	length 22 mm	6
3.545.26	length 26 mm	6
3.545.30	length 30 mm	6
3.545.34	length 34 mm	6
3.545.38	length 38 mm	6
3.545.42	length 42 mm	6
3.545.46	length 46 mm	6
3.545.50	length 50 mm	3
3.545.54	length 54 mm	3
Cortical screw with conical head thread Ø 5.5 mm; fully threaded self tapping; titanium 		
3.549.40	length 40 mm	2
3.549.45	length 45 mm	2
3.549.50	length 50 mm	2
3.549.55	length 55 mm	4
3.549.60	length 60 mm	4
3.549.65	length 65 mm	4
3.549.70	length 70 mm	4
3.549.75	length 75 mm	4
3.549.80	length 80 mm	4
3.549.85	length 85 mm	4
3.549.90	length 90 mm	2
Screw head 		
9.946.05	screw head with conical thread Ø 8.0 mm x 5.0 mm; large fragment; titanium	5

Set Angle-stable Distal Femur Plate

for Screws Ø 4.5/5.5 mm; Large Fragment; Titanium; Set no. 19.602.00



Set no. 19.602.00  Internal hexagon

Item no.	Item description	Quant.
Implants - screws		
	Cortical screw Ø 4.5 mm; fully threaded self tapping; titanium 	
3.152.14	length 14 mm	6
3.152.18	length 18 mm	6
3.152.22	length 22 mm	6
3.152.26	length 26 mm	6
3.152.30	length 30 mm	6
3.152.34	length 34 mm	6
3.152.38	length 38 mm	6
3.152.42	length 42 mm	6
3.152.46	length 46 mm	6
3.152.50	length 50 mm	3
3.152.54	length 54 mm	3

Angle-stable Distal Femur Plate

for Screws Ø 4.5/5.5 mm; Large Fragment; Stainless Steel

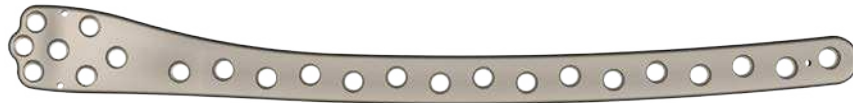

Item no. 4.9482.16

Item no.	Item description
----------	------------------

Distal femur plate with conical thread Ø 4.5 mm to 6.0 mm; plate thickness 4.5 mm; stainless steel

4.9462.04	4 holes; 118 mm x 18 mm; right
4.9462.06	6 holes; 150 mm x 18 mm; right
4.9462.08	8 holes; 182 mm x 18 mm; right
4.9462.10	10 holes; 214 mm x 18 mm; right
4.9462.12	12 holes; 246 mm x 18 mm; right
4.9462.14	14 holes; 277 mm x 18 mm; right
4.9462.16	16 holes; 309 mm x 18 mm; right
4.9472.04	4 holes; 118 mm x 18 mm; left
4.9472.06	6 holes; 150 mm x 18 mm; left
4.9472.08	8 holes; 182 mm x 18 mm; left
4.9472.10	10 holes; 214 mm x 18 mm; left
4.9472.12	12 holes; 246 mm x 18 mm; left
4.9472.14	14 holes; 277 mm x 18 mm; left
4.9472.16	16 holes; 309 mm x 18 mm; left

Distal femur plate with conical thread Ø 4.5 mm to 6.0 mm; plate thickness 6.0 mm; stainless steel

4.9482.08	8 holes; 182 mm x 18 mm; right
4.9482.10	10 holes; 214 mm x 18 mm; right
4.9482.12	12 holes; 246 mm x 18 mm; right
4.9482.14	14 holes; 277 mm x 18 mm; right
4.9482.16	16 holes; 309 mm x 18 mm; right
4.9492.08	8 holes; 182 mm x 18 mm; left
4.9492.10	10 holes; 214 mm x 18 mm; left
4.9492.12	12 holes; 246 mm x 18 mm; left
4.9492.14	14 holes; 277 mm x 18 mm; left
4.9492.16	16 holes; 309 mm x 18 mm; left

Set Angle-stable Distal Femur Plate

for Screws Ø 4.5/5.5 mm; Large Fragment; Stainless Steel; Set no. 19.600.00



Item no. 4.9482.16



Item no. 8.946.05



Set no. 19.600.00  Internal hexagon

Item no.	Item description	Quant.
----------	------------------	--------

Implants - plates

Distal femur plate with conical thread Ø 4.5 mm to 6.0 mm; plate thickness 4.5 mm; stainless steel		
4.9462.06	6 holes; 150 mm x 18 mm; right	1
4.9472.06	6 holes; 150 mm x 18 mm; left	1

Distal femur plate with conical thread Ø 4.5 mm to 6.0 mm; plate thickness 6.0 mm; stainless steel		
4.9482.08	8 holes; 182 mm x 18 mm; right	1
4.9482.12	12 holes; 246 mm x 18 mm; right	1
4.9482.16	16 holes; 309 mm x 18 mm; right	1
4.9492.08	8 holes; 182 mm x 18 mm; left	1
4.9492.12	12 holes; 246 mm x 18 mm; left	1
4.9492.16	16 holes; 309 mm x 18 mm; left	1

Instruments

2.9406.35	hex screwdriver with handle for screws Ø 4.5 mm - Ø 7.0 mm; AF 3.5; length 215 mm; PPSU	1
2.977.02	drill guide for angle stable screwing length 70 mm; large fragment	2
2.977.15	drill guide for angle stable screwing 5.5; length 70 mm	2
2.904.09	drill bit for quick coupling; Ø 3.2 mm x 195 mm spiral length 60 mm; double spiral	1
2.904.23	drill bit for quick coupling; Ø 4.0 mm x 220 mm spiral length 60 mm; double spiral	1
2.954.01	screw forceps; self holding	1
2.953.90	gauge with clasp for screws Ø 4.5 mm/Ø 6.0 mm measuring range 90	1

Wire

6.031.16	Kirschner wire with trocar point and round end Ø 1.6 mm x 150 mm; stainless steel	5
----------	---	---

Container

19.601.00	perforated autoclavable container with inset for instruments and distal femur plates	1
-----------	--	---

Item no.	Item description	Quant.
----------	------------------	--------

Implants - screws

Cortical screw with conical head thread Ø 4.5 mm; fully threaded self tapping; stainless steel 		
2.545.14	length 14 mm	6
2.545.18	length 18 mm	6
2.545.22	length 22 mm	6
2.545.26	length 26 mm	6
2.545.30	length 30 mm	6
2.545.34	length 34 mm	6
2.545.38	length 38 mm	6
2.545.42	length 42 mm	6
2.545.46	length 46 mm	6
2.545.50	length 50 mm	3
2.545.54	length 54 mm	3

Cortical screw with conical head thread Ø 5.5 mm; fully threaded self tapping; stainless steel

2.549.40	length 40 mm	2
2.549.45	length 45 mm	2
2.549.50	length 50 mm	2
2.549.55	length 55 mm	4
2.549.60	length 60 mm	4
2.549.65	length 65 mm	4
2.549.70	length 70 mm	4
2.549.75	length 75 mm	4
2.549.80	length 80 mm	4
2.549.85	length 85 mm	4
2.549.90	length 90 mm	2

Screw head



8.946.05	screw head with conical thread Ø 8.0 mm x 5.0 mm; large fragment; stainless steel	5
----------	---	---

Set Angle-stable Distal Femur Plate

for Screws Ø 4.5/5.5 mm; Large Fragment; Stainless Steel; Set no. 19.600.00



Set no. 19.600.00  Internal hexagon

Item no.	Item description	Quant.
Implants - screws		
Cortical screw Ø 4.5 mm; fully threaded self tapping; stainless steel		
		 Internal hexagon
2.152.14	length 14 mm	6
2.152.18	length 18 mm	6
2.152.22	length 22 mm	6
2.152.26	length 26 mm	6
2.152.30	length 30 mm	6
2.152.34	length 34 mm	6
2.152.38	length 38 mm	6
2.152.42	length 42 mm	6
2.152.46	length 46 mm	6
2.152.50	length 50 mm	3
2.152.54	length 54 mm	3

Extension Set Guide Frame Instruments for Distal Femur

for Screws Ø 4.5/5.5 mm; Large Fragment; Set no. 19.604.00

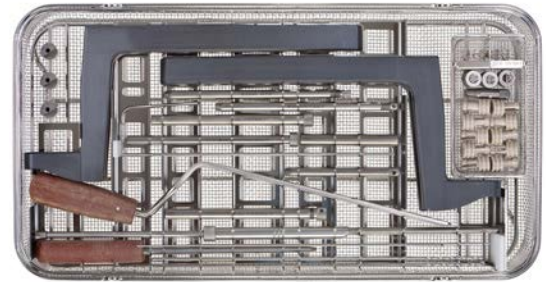

Set no. 19.604.00  Internal hexagon

Item no.	Item description	Quant.
Instruments		
2.940.35/260	hex screwdriver with handle for screw Ø 4.5 mm until Ø 7.0 mm; length 260 mm; wrench width 3.5	1
2.952.032	measuring aid for drill Ø 3.2mm	2
2.952.040	measuring aid for drill Ø 4.0mm	2
10.176.00	guide frame for distal femur plate right	1
10.176.01	guide frame for distal femur plate left	1
10.176.10	sleeve with thread for guide frame; Ø 10 mm x 149 mm	1
10.176.11/1	drill guide for guide frame, Ø 8.0 mm x 167 mm; internal diameter Ø 3.3 mm	3
10.176.11/2	locking cap for drill guide for guide frame; M8 x 0.75 mm	3
10.176.12	trocax for guide frame; Ø 8.0 mm x 160 mm	1
10.176.13	thread wire for guide frame; Ø 3.0 mm x 250 mm	3
10.176.14	wing nut for thread wire for guide frame; M3	3
10.176.15	blind plug for guide frame	10
10.176.16	torsion bar for guide frame; Ø 3.0 x 80 mm	2
10.176.17	sleeve for screws for guide frame; Ø 10 mm x 90 mm	1
10.176.18	drill guide for guide frame; Ø 8.0 mm x 105 mm; internal diameter Ø 4.2 mm	1
10.176.21	drill guide for guide frame; Ø 8.0 mm x 171 mm; internal diameter Ø 1.8 mm	1
10.176.22	drill guide for guide frame; Ø 8.0 mm x 105 mm; internal diameter Ø 3.3 mm	1
10.176.19	sleeve without thread for guide frame; Ø 10 mm x 149 mm	1

Item no.	Item description	Quant.
Instruments		
10.176.20	drill guide for guide frame; Ø 10 mm x 40 mm; internal diameter Ø 1.8 mm	1
10.261.16F	gauge with clasp for distal femur; measuring range 110	1
10.176.24	drill bit for quick coupling; Ø 4.0 mm x 305 mm; spiral length 55 mm; double spiral; with scale	1
10.176.23	drill bit for quick coupling; Ø 3.2 mm x 305 mm; spiral length 55 mm; double spiral; with scale	1
10.508.10	instrument for taking off the tissue	1

Wire		
6.061.16	Kirschner wire with trocar point and round end; Ø 1.6 mm x 280 mm; stainless steel	5

Container		
19.603.00	perforated autoclavable container with inset for extension guide frame instruments	1

Extension Set Guide Frame Instruments for Distal Femur

for Screws \varnothing 4.5/5.5 mm; Large Fragment; Set no. 19.604.00

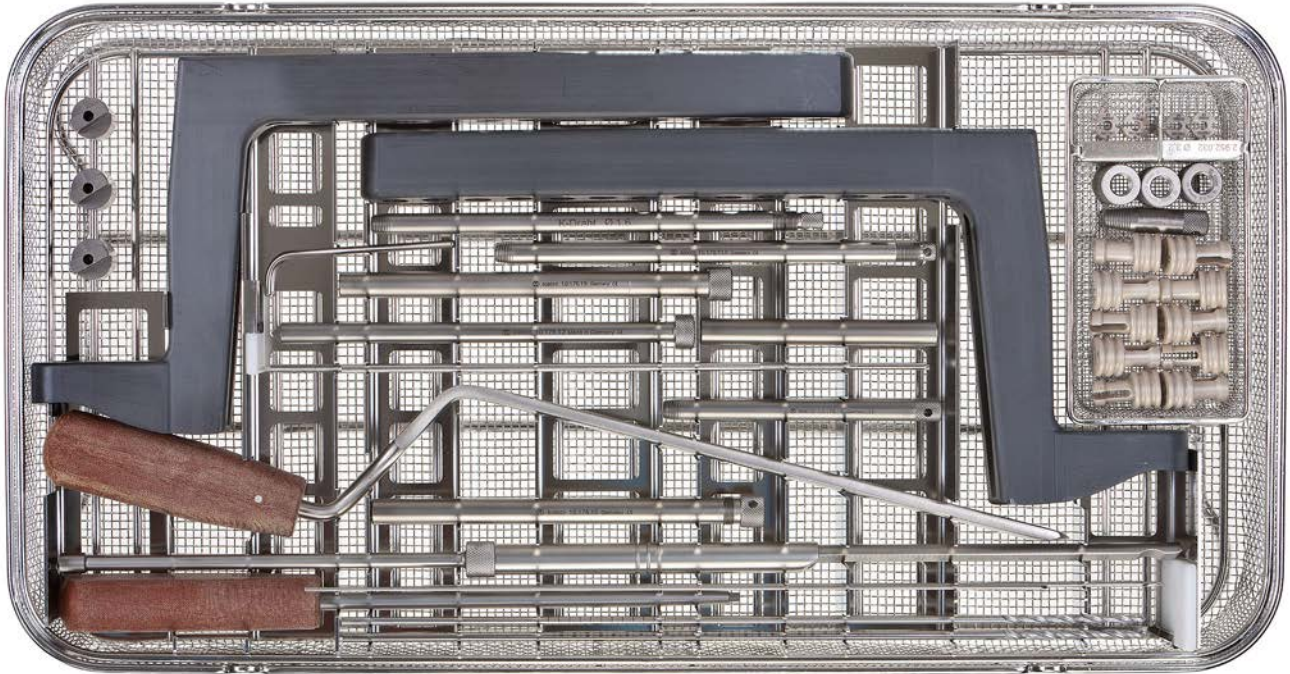

Set no. 19.604.00  Internal hexagon

Femur

Condylar support plate 6.5/4.5

for screws \varnothing 6.5 mm and \varnothing 4.5 mm; titanium



Item no. 5.780.07



Item no. 5.781.07

Item no.	Item description	EAN
Reinforcing condylar plate 6.5/4.5; titanium		
5.780.07	reinforcing condylar plate 6.5/4.5; 7 holes; 158 x 16 mm; right; titanium	4 047075 008377
5.780.09	reinforcing condylar plate 6.5/4.5; 9 holes; 190 x 16 mm; right; titanium	4 047075 008179
5.780.11	reinforcing condylar plate 6.5/4.5; 11 holes; 222 x 16 mm; right; titanium	4 047075 008407
5.780.13	reinforcing condylar plate 6.5/4.5; 13 holes; 254 x 16 mm; right; titanium	4 047075 008414
5.780.14	reinforcing condylar plate 6.5/4.5; 14 holes; 270 x 16 mm; right; titanium	4 047075 111046
5.780.15	reinforcing condylar plate 6.5/4.5; 15 holes; 286 x 16 mm; right; titanium	4 047075 008247
5.780.16	reinforcing condylar plate 6.5/4.5; 16 holes; 302 x 16 mm; right; titanium	4 047075 008438
5.780.18	reinforcing condylar plate 6.5/4.5; 18 holes; 334 x 16 mm; right; titanium	4 047075 008384
5.780.20	reinforcing condylar plate 6.5/4.5; 20 holes; 366 x 16 mm; right; titanium	4 047075 008391
5.781.07	reinforcing condylar plate 6.5/4.5; 7 holes; 158 x 16 mm; left; titanium	4 047075 008469
5.781.09	reinforcing condylar plate 6.5/4.5; 9 holes; 190 x 16 mm; left; titanium	4 047075 008476
5.781.11	reinforcing condylar plate 6.5/4.5; 11 holes; 222 x 16 mm; left; titanium	4 047075 008483
5.781.13	reinforcing condylar plate 6.5/4.5; 13 holes; 254 x 16 mm; left; titanium	4 047075 008490
5.781.15	reinforcing condylar plate 6.5/4.5; 15 holes; 286 x 16 mm; left; titanium	4 047075 008278
5.781.16	reinforcing condylar plate 6.5/4.5; 16 holes; 302 x 16 mm; left; titanium	4 047075 008520
5.781.18	reinforcing condylar plate 6.5/4.5; 18 holes; 334 x 16 mm; left; titanium	4 047075 008537

Condylar support plate 6.5/4.5

for screws \varnothing 6.5 mm and \varnothing 4.5 mm; stainless steel



Item no. 4.780.07



Item no. 4.781.07

Item no.	Item description	EAN
Reinforcing condylar plate 6.5/4.5; stainless steel		
4.780.07	reinforcing condylar plate 6.5/4.5; 7 holes; 158 x 16 mm; right; stainless steel	4 047075 051908
4.780.09	reinforcing condylar plate 6.5/4.5; 9 holes; 190 x 16 mm; right; stainless steel	4 047075 051915
4.780.11	reinforcing condylar plate 6.5/4.5; 11 holes; 222 x 16 mm; right; stainless steel	4 047075 051984
4.780.15	reinforcing condylar plate 6.5/4.5; 15 holes; 286 x 16 mm; right; stainless steel	4 047075 052004
4.781.07	reinforcing condylar plate 6.5/4.5; 7 holes; 158 x 16 mm; left; stainless steel	4 047075 051953
4.781.09	reinforcing condylar plate 6.5/4.5; 9 holes; 190 x 16 mm; left; stainless steel	4 047075 051960
4.781.11	reinforcing condylar plate 6.5/4.5; 11 holes; 222 x 16 mm; left; stainless steel	4 047075 051816
4.781.13	reinforcing condylar plate 6.5/4.5; 13 holes; 254 x 16 mm; left; stainless steel	4 047075 052028

PATELLA

Königsee Implantate



Your Partner in Osteosynthesis

Patella Plate 3.5 vas

Variable angle stable; Titanium



Item no. 5.8513.11

Item no.	Item description
5.8513.11	patella plate with conical thread \varnothing 3.5 mm; head \varnothing 5.0 mm; 11 holes; preshaped; variable angle stable; titanium

Set Patella Plate 3.5 vas

Variable angle stable; Titanium; Set no. 19.671.010



Item no. 5.8513.11

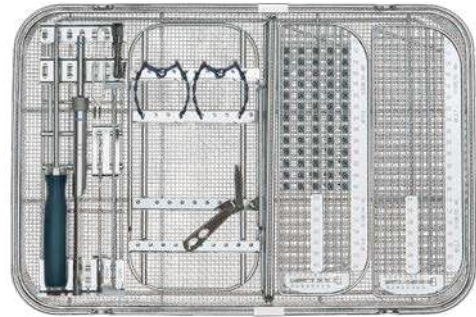



Item no. 19.671.010  Internal hexagon

Item no.	Item description	Quant.
Implants - plates		
5.8513.11	Patella plate with conical thread \varnothing 3.5 mm; head \varnothing 5.0 mm; 11 holes; preshaped; variable angle stable; titanium	2

Instruments		
2.9405.25	hex screwdriver for \varnothing 2.7 mm - \varnothing 4.0 mm; wrench size 2.5 mm; conical; length 215 mm; silicon	1
2.977.12	drill guide with handle for variable angle-stable screwing \varnothing 3.5 mm; with head \varnothing 5.0 mm	1
2.977.13	drill guide for angle stable screws \varnothing 3.5 mm with head \varnothing 5.0 mm; length 44 mm	2
2.904.06	drill bit for quick coupling; \varnothing 2.5 mm x 125 mm; spiral length 60 mm; double spiral	1
2.953.60	gauge with clasp for screws \varnothing 3.5 mm; \varnothing 4.0 mm; measuring range 60 mm	1
2.954.01	screw forceps; self holding	1

Wire		
6.031.10	Kirschner wire with trocar point and round end; \varnothing 1.0 mm x 150 mm; stainless steel	5

Container		
19.670.010	perforated autoclavable container with inset for instruments and implants patella plate; variable angle stable	1

Item no.	Item description	Quant.
Implants - screws		
Cortical screws with conical head thread \varnothing 3.5 mm; fully threaded; head \varnothing 5.0 mm; self-tapping; titanium  Internal hexagon 		
3.136.12	length 12 mm	5
3.136.14	length 14 mm	5
3.136.16	length 16 mm	5
3.136.18	length 18 mm	5
3.136.20	length 20 mm	5
3.136.22	length 22 mm	5
3.136.24	length 24 mm	5
3.136.26	length 26 mm	5
3.136.28	length 28 mm	5
3.136.30	length 30 mm	5
3.136.32	length 32 mm	5
3.136.36	length 36 mm	5
3.136.40	length 40 mm	5

Set Patella Plate 3.5 vas

Variable angle stable; Titanium; Set no. 19.671.010

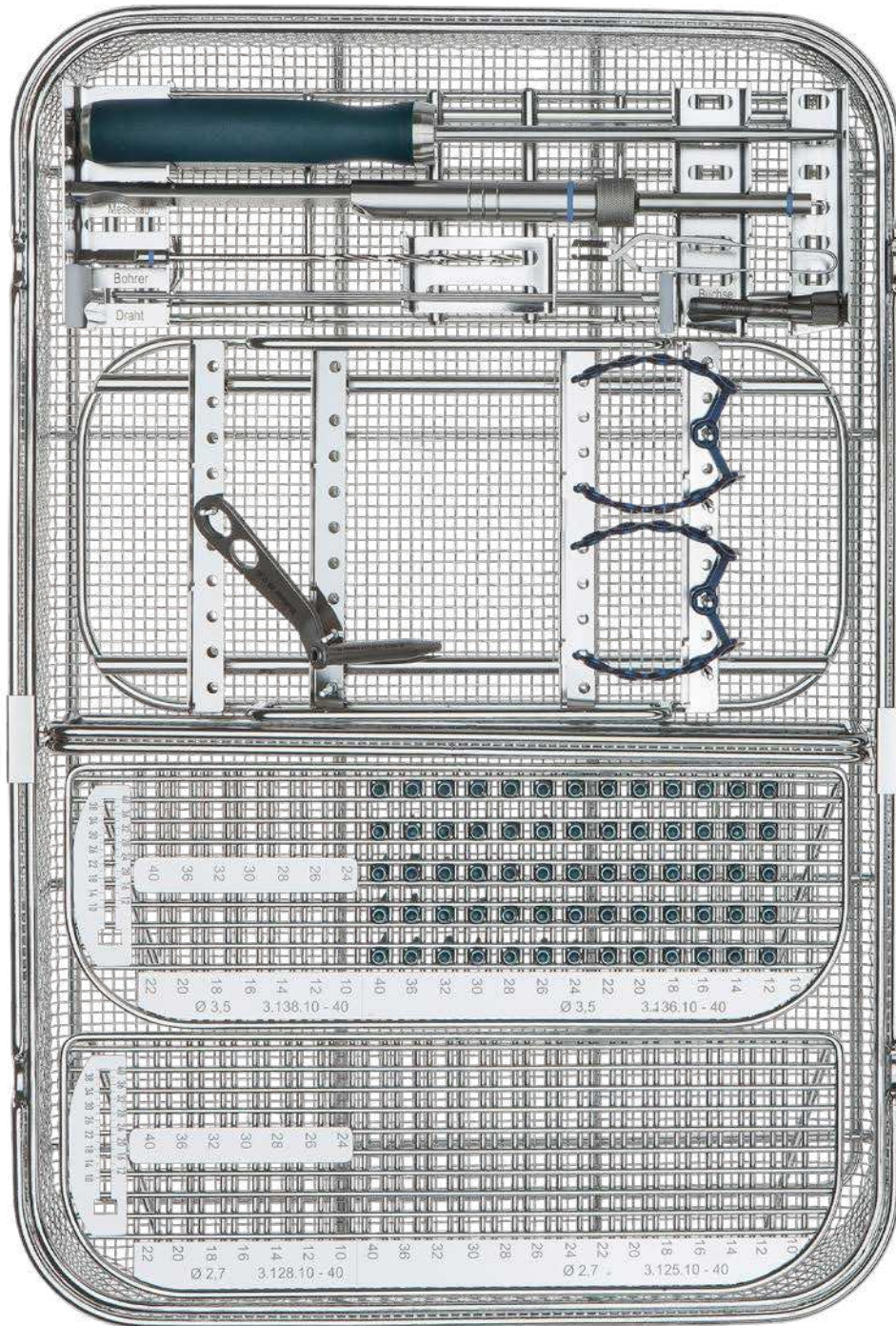

Item no. 19.671.010

 Internal hexagon

TIBIA

Königsee Implantate



Your Partner in Osteosynthesis

VaWiKo® Lateral Tibia Head Plate 4.0

for Screws Ø 4.0 mm; Titanium



Item no. 5.7083.704
7 holes in plate head/ 4 holes in shank



Item no. 5.7073.608
6 holes in plate head/8 holes in shank

Item no.	Item description
----------	------------------

VaWiKo® lateral tibia head plate 4.0; titanium

5.7073.604	VaWiKo® lateral tibia head plate 4.0; 6/4 holes; length 88 mm
5.7073.608	VaWiKo® lateral tibia head plate 4.0; 6/8 holes; length 140 mm
5.7083.704	VaWiKo® lateral tibia head plate 4.0; 7/4 holes; length 88 mm
5.7083.708	VaWiKo® lateral tibia head plate 4.0; 7/8 holes; length 140 mm

Information:

In Germany the system names VaWiKo® are registered Trade Marks. VaWiKo® is derived from the German designation "Variabel winkelstabile Kombination", which translates into English as "Variable Angle-Stable Combination".

This system combines conventional plating technologies with angle-stable locking in variable angles.



Königsee Implantate GmbH
OT Aschau | Am Sand 4
07426 Allendorf | Germany

Fon +49 36738 498 - 560
Fax +49 36738 498 - 89 560

Mail export@koenigsee-implantate.de

For further information please visit:
www.koenigsee-implantate.com

HeBo | Edition 01 | 2019-02
All pictured products are CE compliant.

Set VaWiKo® Lateral Tibia Head Plate 4.0

Titanium; Set no. 19.493.20



Item no. 5.7073.608

Item no. 5.7083.704

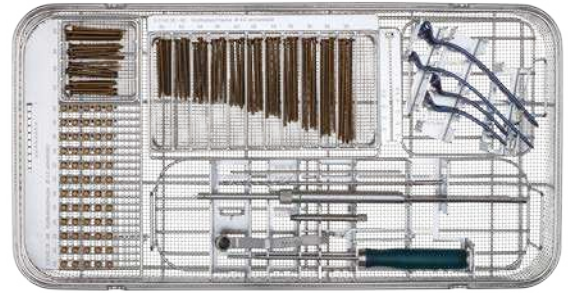

Set no. 19.493.20

★ six lobe

Item no.	Item description	Quant.
Implants - plates		
VaWiKo® lateral tibia head plate 4.0; titanium		
5.7073.604	6/4 holes; length 88 mm	1
5.7073.608	6/8 holes; length 140 mm	1
5.7083.704	7/4 holes; length 88 mm	1
5.7083.708	7/8 holes; length 140 mm	1

Instruments		
2.9385.15	screwdriver with handle for six-lobe 15, length 215 mm	1
2.904.26	drill bit for quick coupling, Ø 3.0 x 195 mm, spiral length 60 mm, double spiral	2
2.953.80	gauge with clasp for screws Ø 3.5 mm, Ø 4.0 mm, measuring range 90 mm	1
2.977.16	drill guide for angle stable screwing 4.0, length 68 mm	2
2.9774.30	sinkhole drill guide for drill Ø 3.0 mm	1
2.954.01	screw forceps, self holding	1

Wire		
6.031.18	Kirschner wire with trocar point and round end, Ø 1.8 x 150 mm, stainless steel	5

Container		
19.492.20	perforated autoclavable container with inset for VaWiKo® lateral tibia head plate and instruments	1

Item no.	Item description	Quant.
Implants - screws		
cortical screw Ø 4.0 mm; angle stable; fully threaded; self tapping; titanium		
		★ six lobe
3.0140.18	length 18 mm	5
3.0140.20	length 20 mm	5
3.0140.22	length 22 mm	5
3.0140.24	length 24 mm	5
3.0140.26	length 26 mm	5
3.0140.28	length 28 mm	5
3.0140.30	length 30 mm	5
3.0140.32	length 32 mm	5
3.0140.34	length 34 mm	5
3.0140.36	length 36 mm	5
3.0140.38	length 38 mm	5
3.0140.40	length 40 mm	5
3.0140.42	length 42 mm	5
3.0140.44	length 44 mm	5
3.0140.46	length 46 mm	5
3.0140.48	length 48 mm	5
3.0140.50	length 50 mm	5
3.0140.52	length 52 mm	5
3.0140.54	length 54 mm	5
3.0140.56	length 56 mm	5
3.0140.60	length 60 mm	5
3.0140.65	length 65 mm	5
3.0140.70	length 70 mm	5
3.0140.75	length 75 mm	5
3.0140.80	length 80 mm	5
3.0140.85	length 85 mm	5
3.0140.90	length 90 mm	5

Set VaWiKo® Lateral Tibia Head Plate 4.0

Titanium; Set no. 19.493.20

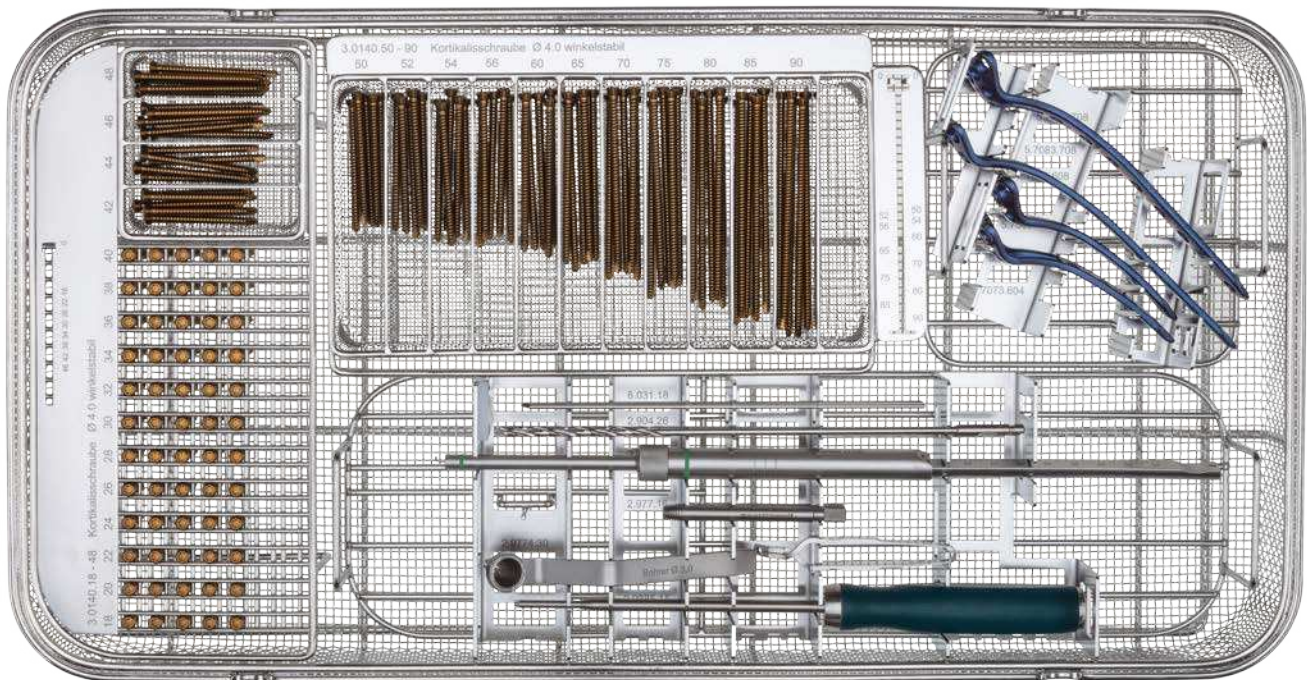

Set no. 19.493.20



Information:

In Germany the system names VaWiKo® are registered Trade Marks. VaWiKo® is derived from the German designation "Variabel winkelstabile Kombination", which translates into English as "Variable Angle-Stable Combination".

This system combines conventional plating technologies with angle-stable locking in variable angles.



Königsee Implantate GmbH
OT Aschau | Am Sand 4
07426 Allendorf | Germany

Fon +49 36738 498 - 560
Fax +49 36738 498 - 89 560

Mail export@koenigsee-implantate.de

For further information please visit:
www.koenigsee-implantate.com

HeBo | Edition 01 | 2019-02
All pictured products are CE compliant.

Set Pestles

Set no. 19.493.30

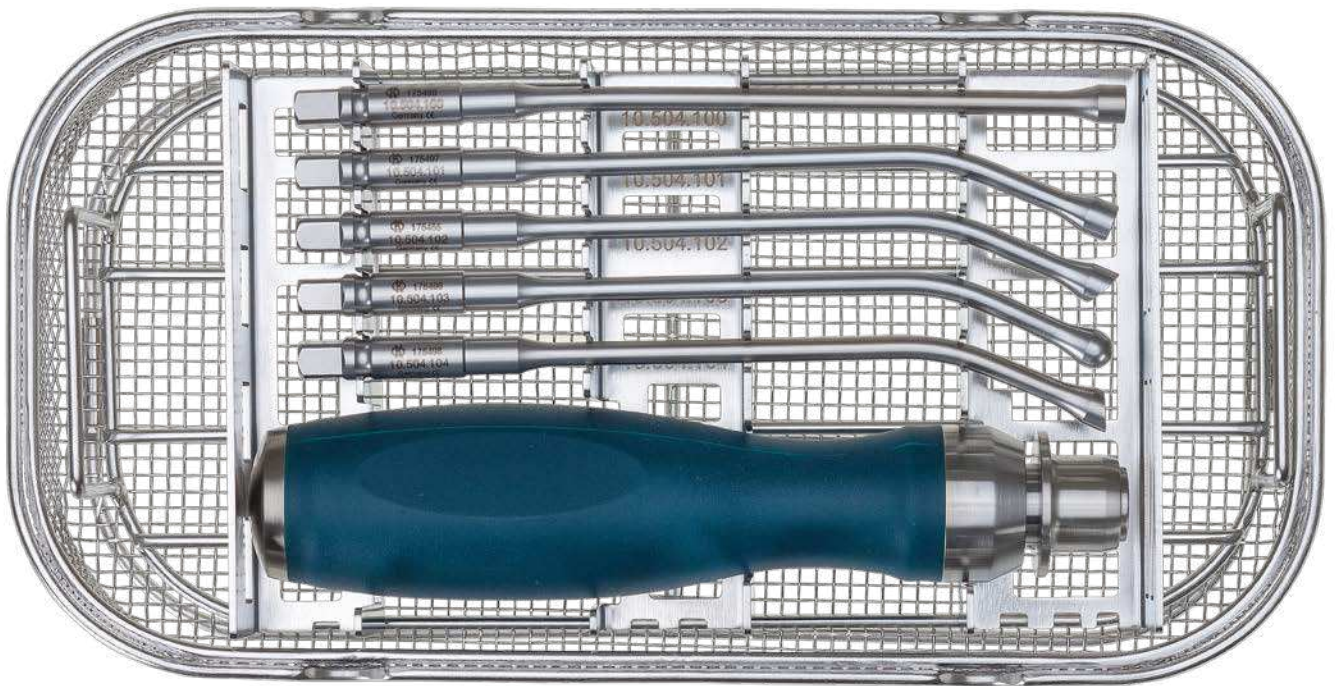

Set no. 19.493.30

Item no.	Item description	Quant.
Instruments – pestles		
pestle; 1/4"-coupling; length 150 mm		
10.504.100	head straight 7 mm	1
10.504.101	angled 25°; head straight 7 mm	1
10.504.102	angled +25°; head beveled 7 mm	1
10.504.103	angled 25°; head round 7 mm	1
10.504.104	angled -25°; head beveled 7 mm	1

Item no.	Item description	Quant.
Instruments – handle		
10.307.03	Handle with 1/4" coupling; length 162	1

Container		
19.492.30	perf. autoclavable container with inset for pestle	1

Angle-stable Königsee HTO Plate

for Screws \varnothing 4.5/6.0 mm; Large Fragment; Titanium



Item no. 5.7242.34



Item no. 5.7252.37



Item no. 5.7221.100



Item no. 3.721.09

Item no.	Item description
----------	------------------

Königsee HTO plate medial with conical thread \varnothing 4.5 mm /6.0 mm; titanium

5.7242.34	3/4 holes; length 63 mm x 17 mm; right
5.7242.37	3/7 holes; length 93 mm x 17 mm; right
5.7252.34	3/4 holes; length 63 mm x 17 mm; left
5.7252.37	3/7 holes; length 93 mm x 17 mm; left

Spacer for Königsee HTO plate; titanium

5.7221.50	8.0 mm x 5.0 mm
5.7221.75	8.0 mm x 7.5 mm
5.7221.100	8.0 mm x 10.0 mm
5.7221.125	8.0 mm x 12.5 mm
5.7221.150	8.0 mm x 15.0 mm

Fixing screw for spacer; titanium

3.721.09	M 4 x 9.0 mm
----------	--------------

Set Angle-stable Königsee HTO Plate

for Screws Ø 4.5/6.0 mm; Large Fragment; Titanium; Set no. 19.357.00



Item no. 5.7252.34



Item no. 5.7221.100



Item no. 5.7252.37



Item no. 3.721.09



Set no. 19.357.00 Internal hexagon

Item no.	Item description	Quant.
Implants - plates		
Königsee HTO plate medial with conical thread Ø 4.5/6.0 mm; titanium		
5.7242.34	3/4 holes; length 63 mm x 17 mm; right	1
5.7252.34	3/4 holes; length 63 mm x 17 mm; left	1
5.7242.37	3/7 holes; length 93 mm x 17 mm; right	1
5.7252.37	3/7 holes; length 93 mm x 17 mm; left	1

Spacer for Königsee HTO plate; titanium		
5.7221.50	8.0 mm x 5.0 mm	2
5.7221.75	8.0 mm x 7.5 mm	2
5.7221.100	8.0 mm x 10.0 mm	2
5.7221.125	8.0 mm x 12.5 mm	2
5.7221.150	8.0 mm x 15.0 mm	2

Fixing screw for spacer; titanium		
3.721.09	M 4 x 9.0 mm	3

Instruments		
2.954.01	screw forceps; self holding	1
2.9406.35	hex screwdriver with handle for screws Ø 4.5 mm - Ø 7.0 mm, AF 3.5 mm, length 215 mm	1
2.9406.25	hex screwdriver with handle for screws Ø 2.7 mm - Ø 4.0 mm, AF 2.5 mm, conical	1
2.941.35	hex screwdriver inset for quick coupling for screws Ø 4.5 mm until Ø 7.0 mm; wrench width 3.5 mm	1
2.904.09	drill bit for quick coupling; Ø 3.2 mm x 195 mm; spiral length 60 mm; double spiral	1
2.953.90	gauge with clasp for screws Ø 4.5 mm; Ø 6.0 mm; measuring range 90 mm	1
2.977.02	drill guide for angle stable screwing; length 70 mm; large fragment	2
10.2406.00	chisel for HTO; thickness 3	1
10.2406.01	chisel for HTO; thickness 5	1
10.2406.02	impactor for wedges	1

Item no.	Item description	Quant.
Implants - screws		
Cortical screw with conical head thread Ø 4.5 mm; fully threaded self tapping; titanium		
 Internal hexagon		
3.545.30	length 30 mm	5
3.545.32	length 32 mm	5
3.545.36	length 36 mm	5
3.545.40	length 40 mm	5
3.545.45	length 45 mm	5
3.545.50	length 50 mm	3
3.545.55	length 55 mm	3
3.545.60	length 60 mm	3

Cancellous screw with conical head thread Ø 6.0 mm; fully threaded self tapping; titanium		
 Internal hexagon		
3.163.40	length 40 mm	3
3.163.45	length 45 mm	3
3.163.50	length 50 mm	3
3.163.55	length 55 mm	5
3.163.60	length 60 mm	5
3.163.65	length 65 mm	5
3.163.70	length 70 mm	5
3.163.75	length 75 mm	5
3.163.80	length 80 mm	5

Wire		
6.031.18	Kirschner wire w. trocar point and round end; Ø 1.8 x 150 mm; stainless steel	5

Container		
19.355.00	perforated autoclavable container with inset for instruments/implants for Königsee HTO plate	1

Set Angle-stable Königsee HTO Plate

for Screws \varnothing 4.5/6.0 mm; Large Fragment; Titanium; Set no. 19.357.00

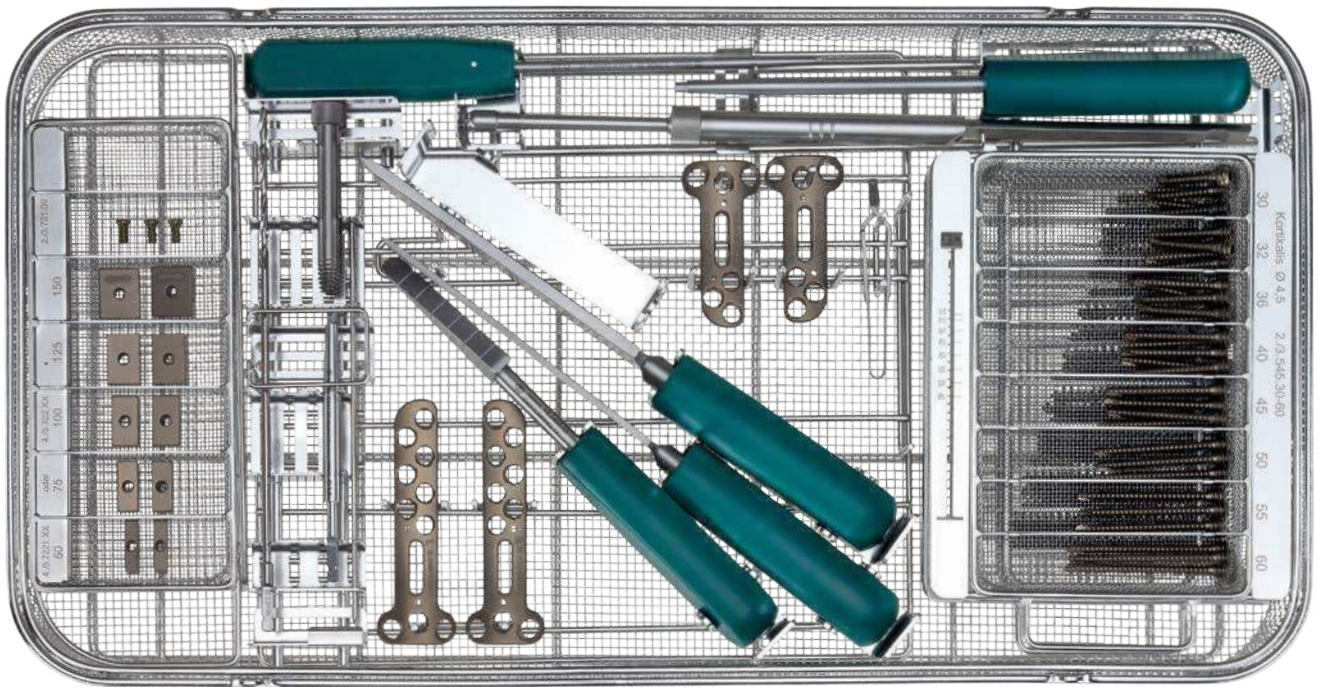

Set no. 19.357.00  Internal hexagon

Angle-stable Lateral T-Tibia Head Plate

for Screws \varnothing 4.5/6.0 mm; Large Fragment; Titanium



Item no. 5.777.44



Item no. 5.778.44

Item no. Item description

T-tibia head plate with conical thread 6.0/4.5; left

5.777.42	2 holes; 65 mm x 14 mm
5.777.43	3 holes; 79 mm x 14 mm
5.777.44	4 holes; 95 mm x 14 mm
5.777.45	5 holes; 111 mm x 14 mm
5.777.46	6 holes; 127 mm x 14 mm
5.777.47	7 holes; 143 mm x 14 mm
5.777.48	8 holes; 159 mm x 14 mm
5.777.49	9 holes; 175 mm x 14 mm
5.777.410	10 holes; 191 mm x 14 mm
5.777.412	12 holes; 223 mm x 14 mm
5.777.414	14 holes; 255 mm x 14 mm
5.777.416	16 holes; 287 mm x 14 mm

T-tibia head plate with conical thread 6.0/4.5; right

5.778.42	2 holes; 65 mm x 14 mm
5.778.43	3 holes; 79 mm x 14 mm
5.778.44	4 holes; 95 mm x 14 mm
5.778.45	5 holes; 111 mm x 14 mm
5.778.46	6 holes; 127 mm x 14 mm
5.778.47	7 holes; 143 mm x 14 mm
5.778.48	8 holes; 159 mm x 14 mm
5.778.49	9 holes; 175 mm x 14 mm
5.778.410	10 holes; 191 mm x 14 mm
5.778.412	12 holes; 223 mm x 14 mm
5.778.414	14 holes; 255 mm x 14 mm
5.778.416	16 holes; 287 mm x 14 mm

Set Angle-stable Lateral T-Tibia Head Plate

for Screws Ø 4.5/6.0 mm; Large Fragment; Titanium; Set no. 19.408.00



Item no. 5.777.44



Item no. 5.778.44



Set no. 19.408.00

Internal hexagon

Item no.	Item description	Quant.
Implants - plates		
T-tibia head plate with conical thread 6.0/4.5; titanium; left		
5.777.44	4 holes; 95 mm x 14 mm	1
5.777.46	6 holes; 127 mm x 14 mm	1
5.777.48	8 holes; 159 mm x 14 mm	1
5.777.410	10 holes; 191 mm x 14 mm	1

T-tibia head plate with conical thread 6.0/4.5; titanium; right		
5.778.44	4 holes; 95 mm x 14 mm	1
5.778.46	6 holes; 127 mm x 14 mm	1
5.778.48	8 holes; 159 mm x 14 mm	1
5.778.410	10 holes; 191 mm x 14 mm	1

Instruments		
2.9406.35	hex screwdriver with handle for screws Ø 4.5 mm - Ø 7.0 mm; AF 3.5 mm; length 215 mm, PPSU	1
2.977.02	drill guide for angle-stable screwing; length 70 mm; large fragment	2
2.904.09	drill bit for quick coupling; Ø 3.2 mm x 195 mm; spiral length 60 mm; double spiral	1
2.954.01	screw forceps; self holding	1
2.953.90	gauge with clasp for screws Ø 4.5 mm; Ø 6.0 mm; measuring range 90 mm	1

Wire		
6.031.18	Kirschner wire with trocar point and round end; Ø 1.8 mm x 150 mm; stainless steel	5

Container		
19.400.00/8	perforated autoclavable container with inset for instruments and proximal tibia head plates	1

Item no.	Item description	Quant.
Implants - screws		
Cortical screw with conical head thread Ø 4.5 mm; fully threaded self tapping; titanium		
		
Internal hexagon		
3.545.18	length 18 mm	5
3.545.20	length 20 mm	5
3.545.22	length 22 mm	5
3.545.24	length 24 mm	5
3.545.26	length 26 mm	5
3.545.28	length 28 mm	5
3.545.30	length 30 mm	5
3.545.32	length 32 mm	5
3.545.34	length 34 mm	5
3.545.36	length 36 mm	5
3.545.38	length 38 mm	5
3.545.40	length 40 mm	5
3.545.42	length 42 mm	5
3.545.45	length 45 mm	5
3.545.50	length 50 mm	5
3.545.55	length 55 mm	5



Cancelous screw with conical head thread Ø 6.0 mm; fully threaded self tapping; titanium		
		
Internal hexagon		
3.163.55	length 55 mm	4
3.163.60	length 60 mm	4
3.163.65	length 65 mm	4
3.163.70	length 70 mm	4
3.163.75	length 75 mm	4
3.163.80	length 80 mm	4
3.163.85	length 85 mm	4
3.163.90	length 90 mm	4

Set Angle-stable Lateral T-Tibia Head Plate

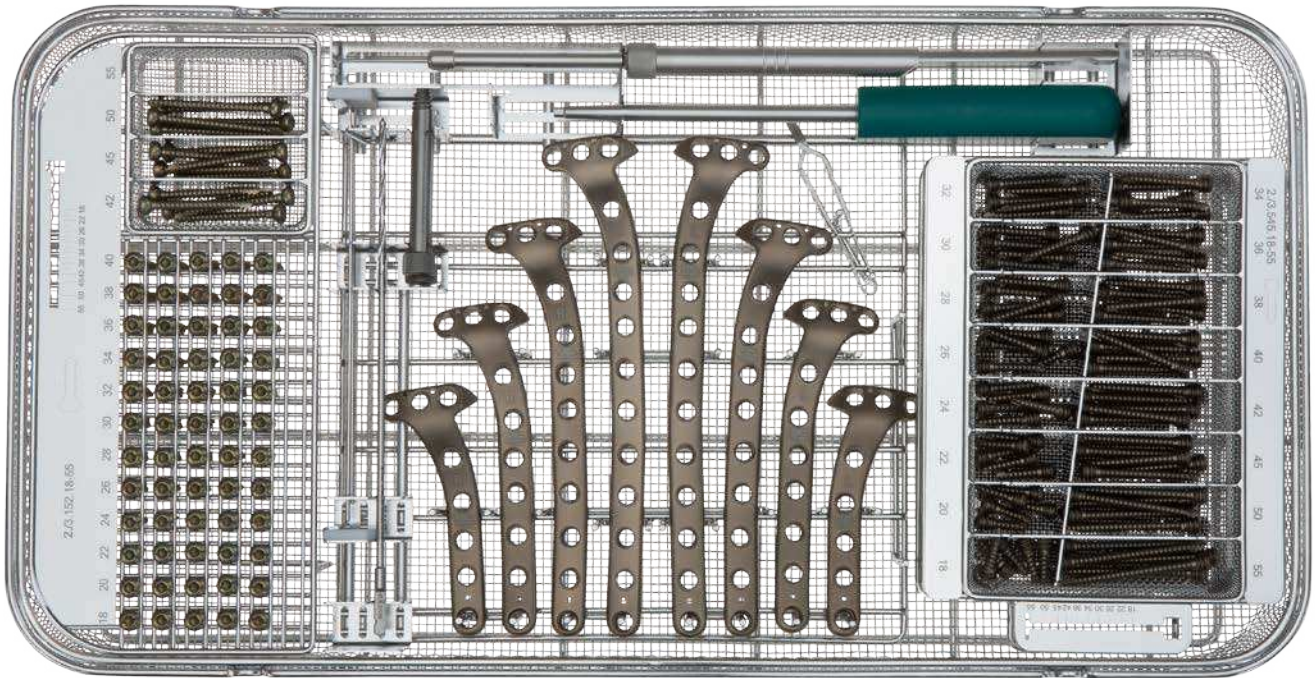
for Screws \varnothing 4.5/6.0 mm; Large Fragment; Titanium; Set no. 19.408.00



Set no. 19.408.00  Internal hexagon

Item no.	Item description	Quant.
Implants - Screws		
Cortical screw \varnothing 4.5 mm fully threaded; self tapping titanium		  Internal hexagon
3.152.18	length 18 mm	5
3.152.20	length 20 mm	5
3.152.22	length 22 mm	5
3.152.24	length 24 mm	5
3.152.26	length 26 mm	5
3.152.28	length 28 mm	5
3.152.30	length 30 mm	5
3.152.32	length 32 mm	5
3.152.34	length 34 mm	5
3.152.36	length 36 mm	5
3.152.38	length 38 mm	5
3.152.40	length 40 mm	5
3.152.42	length 42 mm	5
3.152.45	length 45 mm	5
3.152.50	length 50 mm	5

Angle-stable Lateral T-Tibia Head Plate

for Screws Ø 4.5/6.0 mm; Large Fragment; Stainless Steel



Item no. 4.778.410

Item no.	Item description
----------	------------------

T-tibia head plate with conical thread 6.0/4.5; left

4.777.43	3 holes; 79 mm x 14 mm
4.777.44	4 holes; 95 mm x 14 mm
4.777.45	5 holes; 111 mm x 14 mm
4.777.46	6 holes; 127 mm x 14 mm
4.777.47	7 holes; 143 mm x 14 mm
4.777.48	8 holes; 159 mm x 14 mm
4.777.49	9 holes; 175 mm x 14 mm
4.777.410	10 holes; 191 mm x 14 mm
4.777.412	12 holes; 223 mm x 14 mm
4.777.414	14 holes; 255 mm x 14 mm
4.777.416	16 holes; 287 mm x 14 mm

T-tibia head plate with conical thread 6.0/4.5; right

4.778.43	3 holes; 79 mm x 14 mm
4.778.44	4 holes; 95 mm x 14 mm
4.778.45	5 holes; 111 mm x 14 mm
4.778.46	6 holes; 127 mm x 14 mm
4.778.47	7 holes; 143 mm x 14 mm
4.778.48	8 holes; 159 mm x 14 mm
4.778.49	9 holes; 175 mm x 14 mm
4.778.410	10 holes; 191 mm x 14 mm
4.778.412	12 holes; 223 mm x 14 mm
4.778.414	14 holes; 255 mm x 14 mm
4.778.416	16 holes; 287 mm x 14 mm

Set Angle-stable Lateral T-Tibia Head Plate

for Screws Ø 4.5/6.0 mm; Large Fragment; Stainless Steel; Set no. 19.404.00



Art-Nr. 4.778.410



Set-Nr. 19.404.00 Internal hexagon

Item no.	Item description	Quant.
Implants - plates		
T-tibia head plate with conical thread 6.0/4.5; stainless steel; left		
4.777.44	4 holes; 95 mm x 14 mm	1
4.777.46	6 holes; 127 mm x 14 mm	1
4.777.48	8 holes; 159 mm x 14 mm	1
4.777.410	10 holes; 191 mm x 14 mm	1

T-tibia head plate with conical thread 6.0/4.5; stainless steel; right		
4.778.44	4 holes; 95 mm x 14 mm	1
4.778.46	6 holes; 127 mm x 14 mm	1
4.778.48	8 holes; 159 mm x 14 mm	1
4.778.410	10 holes; 191 mm x 14 mm	1

Instruments		
2.9406.35	hex screwdriver with handle for screws Ø 4.5 mm - Ø 7.0 mm; AF 3.5 mm; length 215 mm, PPSU	1
2.977.02	drill guide for angle-stable screwing; length 70 mm; large fragment	2
2.904.09	drill bit for quick coupling; Ø 3.2 mm x 195 mm; spiral length 60 mm; double spiral	1
2.954.01	screw forceps; self holding	1
2.953.90	gauge with clasp for screws Ø 4.5 mm; Ø 6.0 mm; measuring range 90 mm	1

Wire		
6.031.18	Kirschner wire with trocar point and round end; Ø 1.8 mm x 150 mm; stainless steel	5

Container		
19.400.00/8	perforated autoclavable container with inset for instruments and proximal tibia head plates	1

Item no.	Item description	Quant.
Implants - screws		
Cortical screw with conical head thread Ø 4.5 mm; fully threaded self tapping; stainless steel		
Internal hexagon		
2.545.18	length 18 mm	5
2.545.20	length 20 mm	5
2.545.22	length 22 mm	5
2.545.24	length 24 mm	5
2.545.26	length 26 mm	5
2.545.28	length 28 mm	5
2.545.30	length 30 mm	5
2.545.32	length 32 mm	5
2.545.34	length 34 mm	5
2.545.36	length 36 mm	5
2.545.38	length 38 mm	5
2.545.40	length 40 mm	5
2.545.42	length 42 mm	5
2.545.45	length 45 mm	5
2.545.50	length 50 mm	5
2.545.55	length 55 mm	5



 cancellous screw with conical head thread Ø 6.0 mm; fully threaded self tapping; stainless steel		
Internal hexagon		
2.163.55	length 55 mm	4
2.163.60	length 60 mm	4
2.163.65	length 65 mm	4
2.163.70	length 70 mm	4
2.163.75	length 75 mm	4
2.163.80	length 80 mm	4
2.163.85	length 85 mm	4
2.163.90	length 90 mm	4

Set Angle-stable Lateral T-Tibia Head Plate

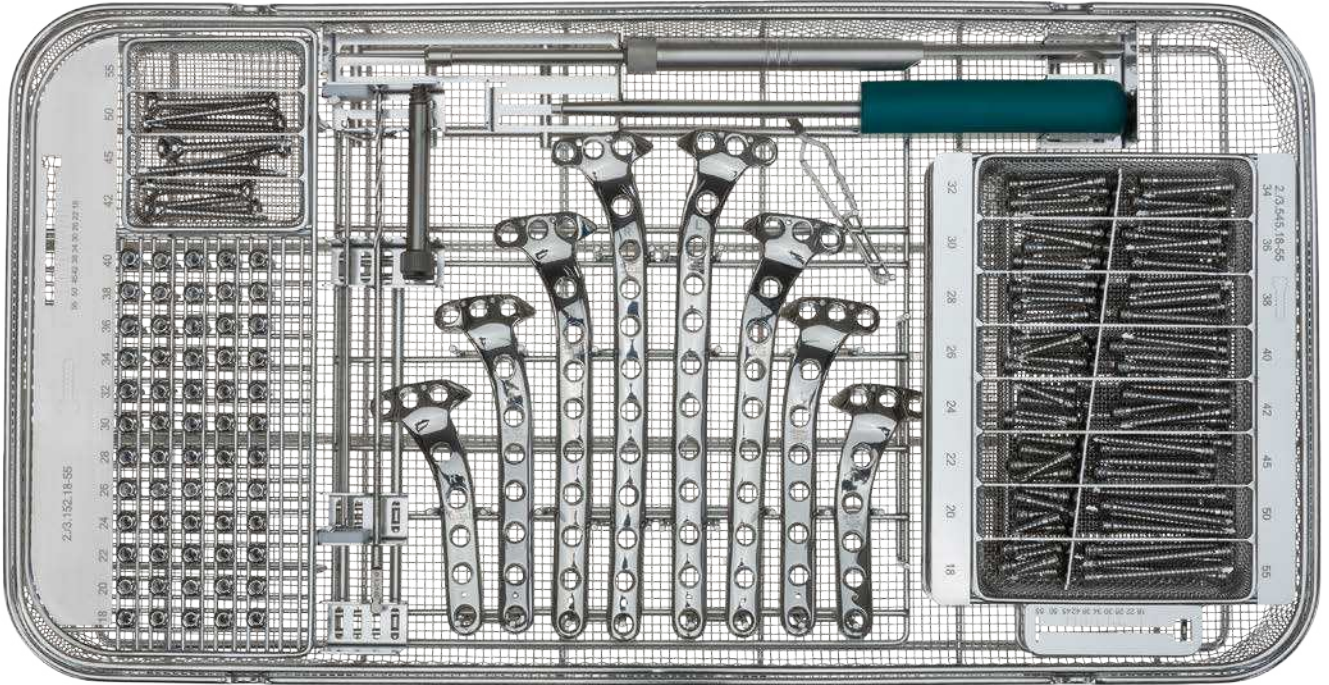
for Screws Ø 4.5/6.0 mm; Large Fragment; Stainless Steel; Set no. 19.404.00



Set no. 19.404.00  Internal hexagon

Item no.	Item description	Quant.
Implants - Screws		
Cortical screw Ø 4.5 mm fully threaded; self tapping stainless steel		
		 Internal hexagon
2.152.18	length 18 mm	5
2.152.20	length 20 mm	5
2.152.22	length 22 mm	5
2.152.24	length 24 mm	5
2.152.26	length 26 mm	5
2.152.28	length 28 mm	5
2.152.30	length 30 mm	5
2.152.32	length 32 mm	5
2.152.34	length 34 mm	5
2.152.36	length 36 mm	5
2.152.38	length 38 mm	5
2.152.40	length 40 mm	5
2.152.42	length 42 mm	5
2.152.45	length 45 mm	5
2.152.50	length 50 mm	5

Angle-stable L-Tibia Head Plate

for Screws \varnothing 4.5/6.0 mm; Large Fragment; Titanium



Item no. 5.773.44



Item no. 5.774.44

Item no. Item description

L-tibia head plate with conical thread 6.0/4.5; left

5.773.43	3 holes; 79 mm x 14 mm
5.773.44	4 holes; 95 mm x 14 mm
5.773.45	5 holes; 111 mm x 14 mm
5.773.46	6 holes; 127 mm x 14 mm
5.773.47	7 holes; 143 mm x 14 mm
5.773.48	8 holes; 159 mm x 14 mm
5.773.49	9 holes; 175 mm x 14 mm
5.773.410	10 holes; 191 mm x 14 mm
5.773.412	12 holes; 223 mm x 14 mm
5.773.414	14 holes; 255 mm x 14 mm
5.773.416	16 holes; 287 mm x 14 mm

L-tibia head plate with conical thread 6.0/4.5; right

5.774.43	3 holes; 79 mm x 14 mm
5.774.44	4 holes; 95 mm x 14 mm
5.774.45	5 holes; 111 mm x 14 mm
5.774.46	6 holes; 127 mm x 14 mm
5.774.47	7 holes; 143 mm x 14 mm
5.774.48	8 holes; 159 mm x 14 mm
5.774.49	9 holes; 175 mm x 14 mm
5.774.410	10 holes; 191 mm x 14 mm
5.774.412	12 holes; 223 mm x 14 mm
5.774.414	14 holes; 255 mm x 14 mm
5.774.416	16 holes; 287 mm x 14 mm

Set Angle-stable L-Tibia Head Plate

for Screws Ø 4.5/6.0 mm; Large Fragment; Titanium; Set no. 19.406.00



Item no. 5.773.44



Item no. 5.774.44



Set no. 19.406.00

Internal hexagon

Item no.	Item description	Quant.
Implants - plates		
L-tibia head plate with conical thread 6.0/4.5; titanium; left		
5.773.44	4 holes; 95 mm x 14 mm	1
5.773.46	6 holes; 127 mm x 14 mm	1
5.773.48	8 holes; 159 mm x 14 mm	1
5.773.410	10 holes; 191 mm x 14 mm	1

L-tibia head plate with conical thread 6.0/4.5; titanium; right		
5.774.44	4 holes; 95 mm x 14 mm	1
5.774.46	6 holes; 127 mm x 14 mm	1
5.774.48	8 holes; 159 mm x 14 mm	1
5.774.410	10 holes; 191 mm x 14 mm	1

Instruments		
2.9406.35	hex screwdriver with handle for screws Ø 4.5 mm - Ø 7.0 mm; AF 3.5 mm; length 215 mm, PPSU	1
2.977.02	drill guide for angle-stable screwing; length 70 mm; large fragment	2
2.904.09	drill bit for quick coupling; Ø 3.2 mm x 195 mm; spiral length 60 mm; double spiral	1
2.954.01	screw forceps; self holding	1
2.953.90	gauge with clasp for screws Ø 4.5 mm; Ø 6.0 mm; measuring range 90 mm	1

Wire		
6.031.18	Kirschner wire with trocar point and round end; Ø 1.8 mm x 150 mm; stainless steel	5

Container		
19.400.00/8	perforated autoclavable container with inset for instruments and proximal tibia head plates	1

Item no.	Item description	Quant.
Implants - screws		
Cortical screw with conical head thread Ø 4.5 mm; fully threaded self tapping; titanium		
		
Internal hexagon		
3.545.18	length 18 mm	5
3.545.20	length 20 mm	5
3.545.22	length 22 mm	5
3.545.24	length 24 mm	5
3.545.26	length 26 mm	5
3.545.28	length 28 mm	5
3.545.30	length 30 mm	5
3.545.32	length 32 mm	5
3.545.34	length 34 mm	5
3.545.36	length 36 mm	5
3.545.38	length 38 mm	5
3.545.40	length 40 mm	5
3.545.42	length 42 mm	5
3.545.45	length 45 mm	5
3.545.50	length 50 mm	5
3.545.55	length 55 mm	5



Cancelous screw with conical head thread Ø 6.0 mm; fully threaded self tapping; titanium		
		
Internal hexagon		
3.163.55	length 55 mm	4
3.163.60	length 60 mm	4
3.163.65	length 65 mm	4
3.163.70	length 70 mm	4
3.163.75	length 75 mm	4
3.163.80	length 80 mm	4
3.163.85	length 85 mm	4
3.163.90	length 90 mm	4

Set Angle-stable Lateral L-Tibia Head Plate

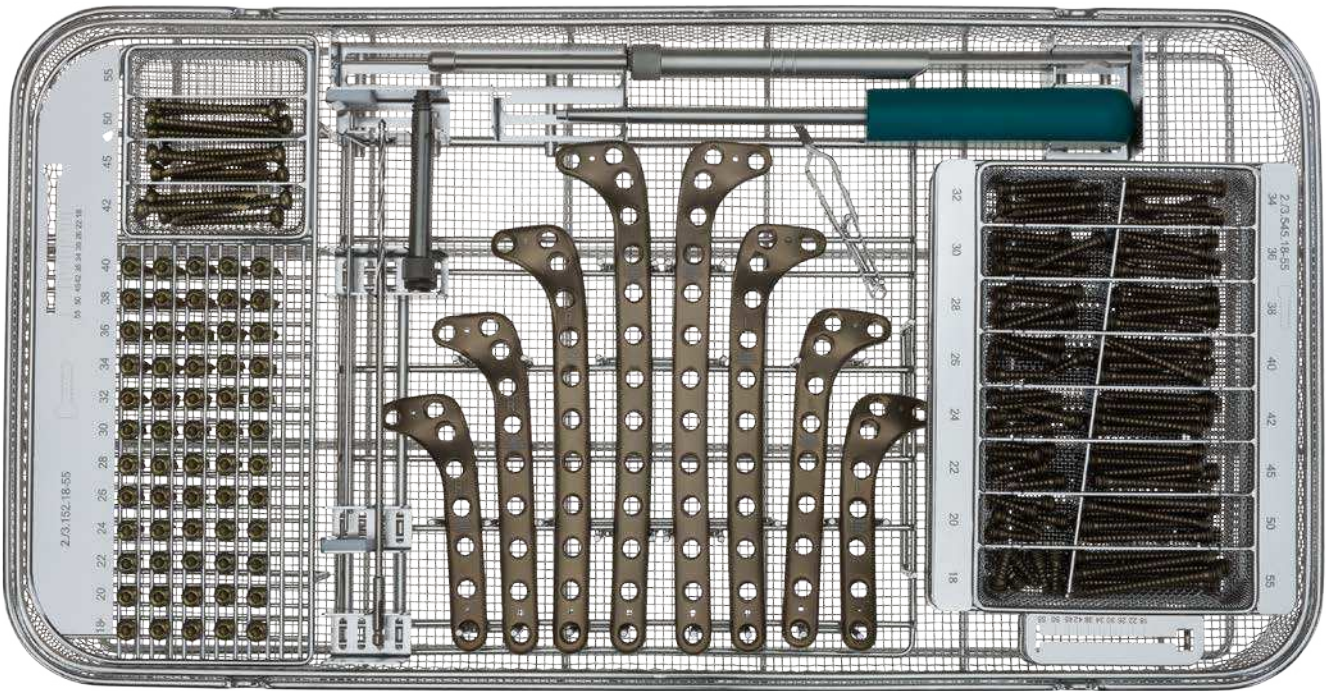
for Screws Ø 4.5/6.0 mm; Large Fragment; Titanium; Set no. 19.406.00



Set no. 19.406.00  Internal hexagon

Item no.	Item description	Quant.
Implants - Screws		
Cortical screw Ø 4.5 mm fully threaded; self tapping titanium		  Internal hexagon
3.152.18	length 18 mm	5
3.152.20	length 20 mm	5
3.152.22	length 22 mm	5
3.152.24	length 24 mm	5
3.152.26	length 26 mm	5
3.152.28	length 28 mm	5
3.152.30	length 30 mm	5
3.152.32	length 32 mm	5
3.152.34	length 34 mm	5
3.152.36	length 36 mm	5
3.152.38	length 38 mm	5
3.152.40	length 40 mm	5
3.152.42	length 42 mm	5
3.152.45	length 45 mm	5
3.152.50	length 50 mm	5

Angle-stable L-Tibia Head Plate

for Screws \varnothing 4.5/6.0 mm; Large Fragment; Stainless Steel



Item no. 4.773.44



Item no. 4.774.44

Item no. Item description

L-tibia head plate with conical thread 6.0/4.5; left

4.773.43	3 holes; 79 mm x 14 mm
4.773.44	4 holes; 95 mm x 14 mm
4.773.45	5 holes; 111 mm x 14 mm
4.773.46	6 holes; 127 mm x 14 mm
4.773.47	7 holes; 143 mm x 14 mm
4.773.48	8 holes; 159 mm x 14 mm
4.773.49	9 holes; 175 mm x 14 mm
4.773.410	10 holes; 191 mm x 14 mm
4.773.412	12 holes; 223 mm x 14 mm
4.773.414	14 holes; 255 mm x 14 mm
4.773.416	16 holes; 287 mm x 14 mm

L-tibia head plate with conical thread 6.0/4.5; right

4.774.43	3 holes; 79 mm x 14 mm
4.774.44	4 holes; 95 mm x 14 mm
4.774.45	5 holes; 111 mm x 14 mm
4.774.46	6 holes; 127 mm x 14 mm
4.774.47	7 holes; 143 mm x 14 mm
4.774.48	8 holes; 159 mm x 14 mm
4.774.49	9 holes; 175 mm x 14 mm
4.774.410	10 holes; 191 mm x 14 mm
4.774.412	12 holes; 223 mm x 14 mm
4.774.414	14 holes; 255 mm x 14 mm
4.774.416	16 holes; 287 mm x 14 mm

Set Angle-stable Lateral L-Tibia Head Plate

for Screws Ø 4.5/6.0 mm; Large Fragment; Stainless Steel; Set no. 19.402.00



Item no. 4.773.44



Set no. 19.402.00

 Internal hexagon



Item no.	Item description	Quant.
Implants - plates		
L-tibia head plate with conical thread 6.0/4.5; stainless steel; left		
4.773.44	4 holes; 95 mm x 14 mm	1
4.773.46	6 holes; 127 mm x 14 mm	1
4.773.48	8 holes; 159 mm x 14 mm	1
4.773.410	10 holes; 191 mm x 14 mm	1



L-tibia head plate with conical thread 6.0/4.5; stainless steel; right		
4.774.44	4 holes; 95 mm x 14 mm	1
4.774.46	6 holes; 127 mm x 14 mm	1
4.774.48	8 holes; 159 mm x 14 mm	1
4.774.410	10 holes; 191 mm x 14 mm	1

Instruments		
2.9406.35	hex screwdriver with handle for screws Ø 4.5 mm - Ø 7.0 mm; AF 3.5 mm; length 215 mm, PPSU	1
2.977.02	drill guide for angle-stable screwing; length 70 mm; large fragment	2
2.904.09	drill bit for quick coupling; Ø 3.2 mm x 195 mm; spiral length 60 mm; double spiral	1
2.954.01	screw forceps; self holding	1
2.953.90	gauge with clasp for screws Ø 4.5 mm; Ø 6.0 mm; measuring range 90 mm	1

Wire		
6.031.18	Kirschner wire with trocar point and round end; Ø 1.8 mm x 150 mm; stainless steel	5

Container		
19.400.00/8	perforated autoclavable container with inset for instruments and proximal tibia head plates	1

Item no.	Item description	Quant.
Implants - screws		
Cortical screw with conical head thread Ø 4.5 mm; fully threaded self tapping; stainless steel		
		
 Internal hexagon		
2.545.18	length 18 mm	5
2.545.20	length 20 mm	5
2.545.22	length 22 mm	5
2.545.24	length 24 mm	5
2.545.26	length 26 mm	5
2.545.28	length 28 mm	5
2.545.30	length 30 mm	5
2.545.32	length 32 mm	5
2.545.34	length 34 mm	5
2.545.36	length 36 mm	5
2.545.38	length 38 mm	5
2.545.40	length 40 mm	5
2.545.42	length 42 mm	5
2.545.45	length 45 mm	5
2.545.50	length 50 mm	5
2.545.55	length 55 mm	5



 cancellous screw with conical head thread Ø 6.0 mm; fully threaded self tapping; stainless steel		
		
 Internal hexagon		
2.163.55	length 55 mm	4
2.163.60	length 60 mm	4
2.163.65	length 65 mm	4
2.163.70	length 70 mm	4
2.163.75	length 75 mm	4
2.163.80	length 80 mm	4
2.163.85	length 85 mm	4
2.163.90	length 90 mm	4

Set Angle-stable Lateral L-Tibia Head Plate

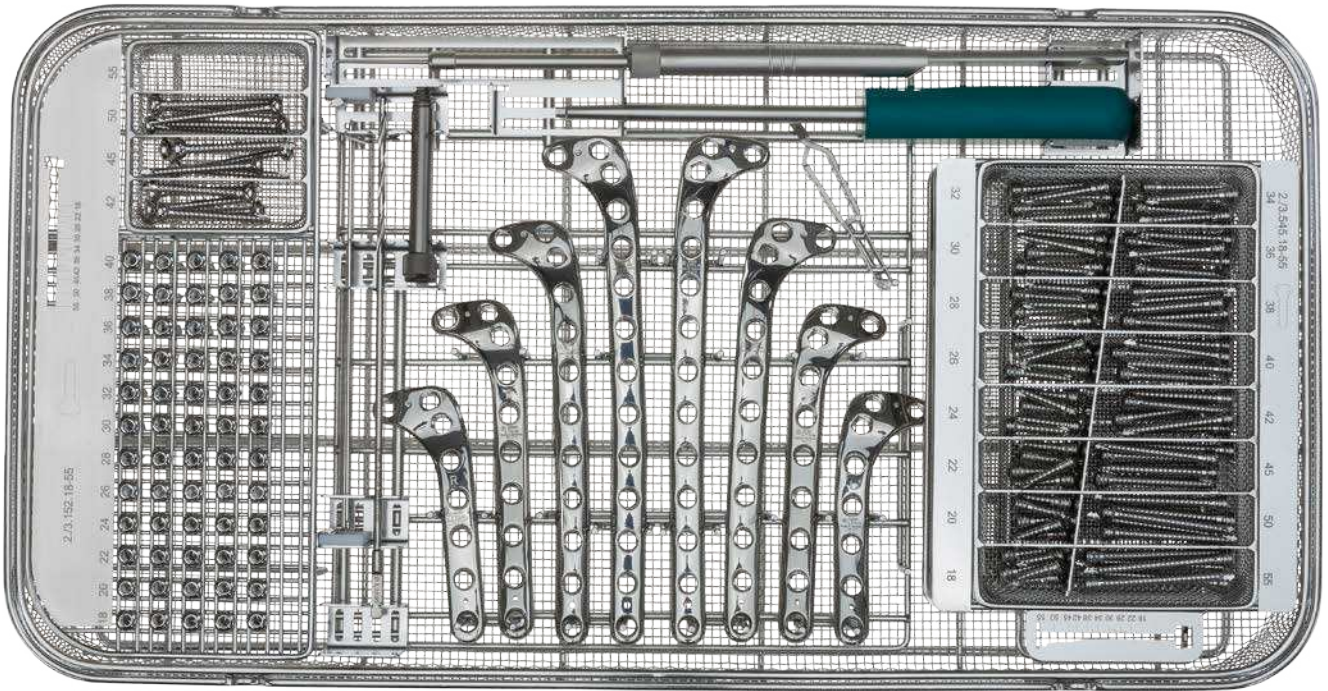
for Screws Ø 4.5/6.0 mm; Large Fragment; Stainless Steel; Set no. 19.402.00



Set no. 19.402.00  Internal hexagon

Item no.	Item description	Quant.
Implants - Screws		
Cortical screw Ø 4.5 mm fully threaded; self tapping stainless steel		
		 Internal hexagon
2.152.18	length 18 mm	5
2.152.20	length 20 mm	5
2.152.22	length 22 mm	5
2.152.24	length 24 mm	5
2.152.26	length 26 mm	5
2.152.28	length 28 mm	5
2.152.30	length 30 mm	5
2.152.32	length 32 mm	5
2.152.34	length 34 mm	5
2.152.36	length 36 mm	5
2.152.38	length 38 mm	5
2.152.40	length 40 mm	5
2.152.42	length 42 mm	5
2.152.45	length 45 mm	5
2.152.50	length 50 mm	5

Angle-stable Medial Tibia Head Plate

for Screws \varnothing 4.5/6.0 mm; Titanium



Item no. 5.7192.36, left



Item no. 5.7182.36, right

Item no.	Item description
----------	------------------

Medial tibia head plate \varnothing 4.5 mm - 6.0 mm; angle-stable; titanium; left

5.7192.34	4 holes; 77 mm x 14 mm
5.7192.36	6 holes; 109 mm x 14 mm
5.7192.38	8 holes; 141 mm x 14 mm
5.7192.310	10 holes; 173 mm x 14 mm
5.7192.312	12 holes; 205 mm x 14 mm
5.7192.314	14 holes; 237 mm x 14 mm
5.7192.316	16 holes; 269 mm x 14 mm
5.7192.318	18 holes; 301 mm x 14 mm

Medial tibia head plate \varnothing 4.5 mm - 6.0 mm; angle-stable; titanium; right

5.7182.34	4 holes; 77 mm x 14 mm
5.7182.36	6 holes; 109 mm x 14 mm
5.7182.38	8 holes; 141 mm x 14 mm
5.7182.310	10 holes; 173 mm x 14 mm
5.7182.312	12 holes; 205 mm x 14 mm
5.7182.314	14 holes; 237 mm x 14 mm
5.7182.316	16 holes; 269 mm x 14 mm
5.7182.318	18 holes; 301 mm x 14 mm

Set Angle-stable Medial Tibia Head Plate

for Screws Ø 4.5/6.0 mm; Titanium; Set no. 19.409.00



Item no. 5.7192.36



Item no. 5.7182.36



Set no. 19.409.00

Internal hexagon

Item no.	Item description	Quant.
Implants - plates		
Medial tibia head plate Ø 4.5 mm - 6.0 mm; titanium; angle-stable		
5.7192.34	4 holes; 77 mm x 14 mm; left	1
5.7192.36	6 holes; 109 mm x 14 mm; left	1
5.7192.38	8 holes; 141 mm x 14 mm; left	1
5.7182.34	4 holes; 77 mm x 14 mm; right	1
5.7182.36	6 holes; 109 mm x 14 mm; right	1
5.7182.38	8 holes; 141 mm x 14 mm; right	1

Instruments		
2.9405.35	hex screwdriver for Ø 4.5 mm - Ø 7.0 mm; wrench size 3.5 mm; length 215 mm; silicone	1
2.904.09	drill bit for quick coupling; Ø 3.2 mm x 195 mm; spiral length 60 mm; double spiral	1
2.977.02	drill guide for angle stable screwing; length 70 mm; big fragment	2
2.953.90	gauge with clasp for screws Ø 4.5 mm; Ø 6.0 mm; measuring range 90 mm	1
2.954.01	screw forceps; self holding	1
10.502.32	universal drill guide; Ø 3.2 mm	1

Wire		
6.031.18	Kirschner wire with trocar point and round end; Ø 1.8 mm x 150 mm; stainless steel	5

Container		
19.400.10	perforated autoclavable container with inset for instruments and medial tibia head plates	1

Item no.	Item description	Quant.
Implants - screws		
Canellous screw with conical head thread Ø 6.0 mm; fully threaded; self tapping; titanium		
		
Internal hexagon		
3.163.55	length 55 mm	4
3.163.60	length 60 mm	4
3.163.65	length 65 mm	4
3.163.70	length 70 mm	4
3.163.75	length 75 mm	4

Cortical screw with conical head thread Ø 4.5 mm; fully threaded; self tapping; titanium		
		
Internal hexagon		
3.545.18	length 18 mm	5
3.545.20	length 20 mm	5
3.545.22	length 22 mm	5
3.545.24	length 24 mm	5
3.545.26	length 26 mm	5
3.545.28	length 28 mm	5
3.545.30	length 30 mm	5
3.545.32	length 32 mm	5
3.545.34	length 34 mm	5
3.545.36	length 36 mm	5
3.545.38	length 38 mm	5
3.545.40	length 40 mm	5
3.545.42	length 42 mm	5
3.545.45	length 45 mm	5
3.545.50	length 50 mm	5
3.545.55	length 55 mm	5

Set Angle-stable Medial Tibia Head Plate

for Screws Ø 4.5/6.0 mm; Titanium; Set no. 19.409.00

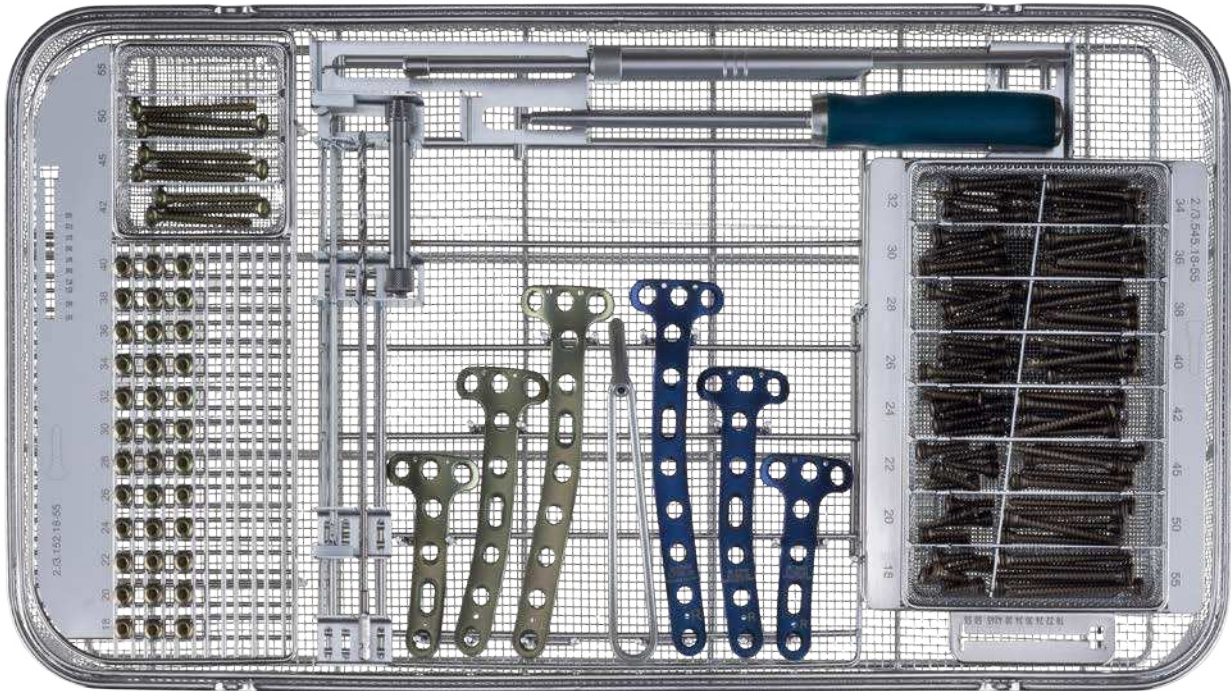

Set no. 19.409.00

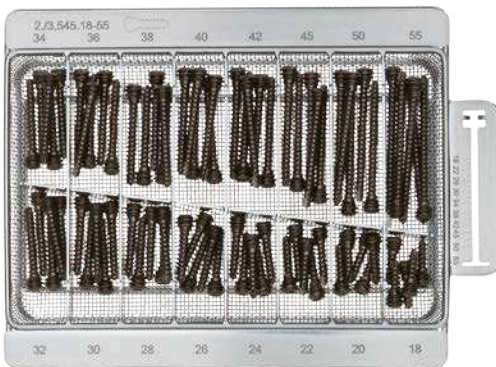

 Internal hexagon

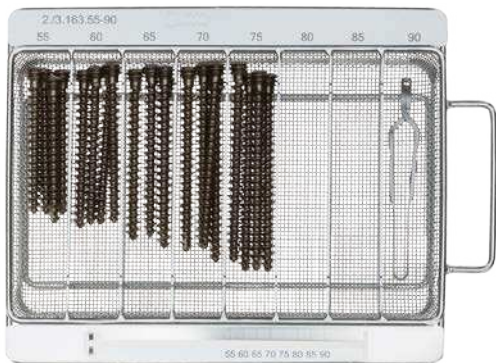

Cortical screws



Cancellous screws

Item no.	Item description	Quant.
Implants - screws		
Cortical screw Ø 4.5 mm; fully threaded; self tapping; titanium		
		 Internal hexagon
3.152.18	length 18 mm	3
3.152.20	length 20 mm	3
3.152.22	length 22 mm	3
3.152.24	length 24 mm	3
3.152.26	length 26 mm	3
3.152.28	length 28 mm	3
3.152.30	length 30 mm	3
3.152.32	length 32 mm	3
3.152.34	length 34 mm	3
3.152.36	length 36 mm	3
3.152.38	length 38 mm	3
3.152.40	length 40 mm	3
3.152.42	length 42 mm	3
3.152.45	length 45 mm	3
3.152.50	length 50 mm	3

Angle-stable Distal Tibia Plate - Medial

Small Fragment; for Screws \varnothing 3.5 mm/4.0 mm; Titanium



Item no. 5.7332.05



Item no. 5.7322.05

Item no.	Item description
----------	------------------

Distal tibia plate with conical thread \varnothing 3.5 mm; medial; titanium; right

5.7322.03	3 holes; 76 mm x 14 mm
5.7322.05	5 holes; 108 mm x 14 mm
5.7322.07	7 holes; 140 mm x 14 mm
5.7322.09	9 holes; 172 mm x 14 mm
5.7322.11	11 holes; 204 mm x 14 mm
5.7322.13	13 holes; 236 mm x 14 mm
5.7322.15	15 holes; 268 mm x 14 mm

Distal tibia plate with conical thread \varnothing 3.5 mm; medial; titanium; left

5.7332.03	3 holes; 76 mm x 14 mm
5.7332.05	5 holes; 108 mm x 14 mm
5.7332.07	7 holes; 140 mm x 14 mm
5.7332.09	9 holes; 172 mm x 14 mm
5.7332.11	11 holes; 204 mm x 14 mm
5.7332.13	13 holes; 236 mm x 14 mm
5.7332.15	15 holes; 268 mm x 14 mm

Variable Angle-stable Distal Tibia Plate - Medial

Small Fragment; for Screws \varnothing 3.5 mm/4.0 mm; Titanium



Item no. 5.733.05



Item no. 5.732.05

Item no.	Item description
----------	------------------

Distal tibia plate with conical thread \varnothing 3.5 mm; right; medial; variable angle-stable; titanium

5.732.03	3 holes; 76 mm x 14 mm
5.732.05	5 holes; 108 mm x 14 mm
5.732.07	7 holes; 140 mm x 14 mm
5.732.09	9 holes; 172 mm x 14 mm
5.732.11	11 holes; 204 mm x 14 mm
5.732.13	13 holes; 236 mm x 14 mm
5.732.15	15 holes; 268 mm x 14 mm

Distal tibia plate with conical thread \varnothing 3.5 mm; left; medial; variable angle-stable; titanium

5.733.03	3 holes; 76 mm x 14 mm
5.733.05	5 holes; 108 mm x 14 mm
5.733.07	7 holes; 140 mm x 14 mm
5.733.09	9 holes; 172 mm x 14 mm
5.733.11	11 holes; 204 mm x 14 mm
5.733.13	13 holes; 236 mm x 14 mm
5.733.15	15 holes; 268 mm x 14 mm

Set Variable Angle-stable Distal Tibia plate

Small Fragment; for Screws Ø 3.5 mm; Titanium; Set no. 19.491.00



Item no. 5.732.05



Item no. 5.733.05

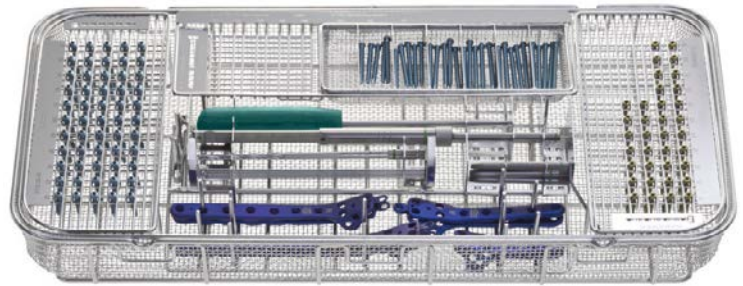

Set no. 19.491.00  Internal hexagon



Item no.	Item description	Quant.
Implants - plates		
Distal Tibia plate with conical thread Ø 3.5 mm medial; variable angle-stable; titanium; right		
5.732.03	3 holes, 76 mm x 14 mm	1
5.732.05	5 holes, 108 mm x 14 mm	1
5.732.07	7 holes, 140 mm x 14 mm	1
5.732.09	9 holes, 172 mm x 14 mm	1

Distal Tibia plate with conical thread Ø 3.5 mm medial; variable angle-stable; titanium; left		
5.733.03	3 holes, 76 mm x 14 mm	1
5.733.05	5 holes, 108 mm x 14 mm	1
5.733.07	7 holes, 140 mm x 14 mm	1
5.733.09	9 holes, 172 mm x 14 mm	1

Instruments		
2.904.22	drill bit for quick coupling; Ø 2.5 mm x 155 mm; spiral length 60 mm, double spiral	2
2.977.04	drill guide for angle-stable screwing; length 68 mm; small fragment	2
2.977.09	drill guide with handle for variable angle-stable screwing; small fragment; length 68 mm	1
2.9406.25	hex screwdriver with handle for screws Ø 2.7 mm - Ø 4.0 mm; AF 2.5 mm; conical; PPSU	1
2.953.70	gauge with clasp for screws Ø 3.5 mm; Ø 4.0 mm; measuring range 70 mm	1
2.954.01	screw forceps; self holding	1

Wire		
6.031.18	Kirschner wire with trocar point and round end; Ø 1.8 mm x 150 mm; stainless steel	5

Container		
19.490.00	perforated autoclavable container with inset for instruments and distal tibia plates	1



Item no.	Item description	Quant.
Implants - screws		
Cortical screw with conical head thread Ø 3.5 mm; fully threaded; self tapping; titanium 		
 Internal hexagon		
3.133.20	length 20 mm	5
3.133.22	length 22 mm	5
3.133.24	length 24 mm	5
3.133.26	length 26 mm	5
3.133.28	length 28 mm	5
3.133.30	length 30 mm	5
3.133.32	length 32 mm	5
3.133.34	length 34 mm	5
3.133.36	length 36 mm	5
3.133.38	length 38 mm	5
3.133.40	length 40 mm	5
3.133.42	length 42 mm	5
3.133.45	length 45 mm	5
3.133.48	length 48 mm	5
3.133.50	length 50 mm	5
3.133.55	length 55 mm	5
3.133.60	length 60 mm	5

Set Variable Angle-stable Distal Tibia plate

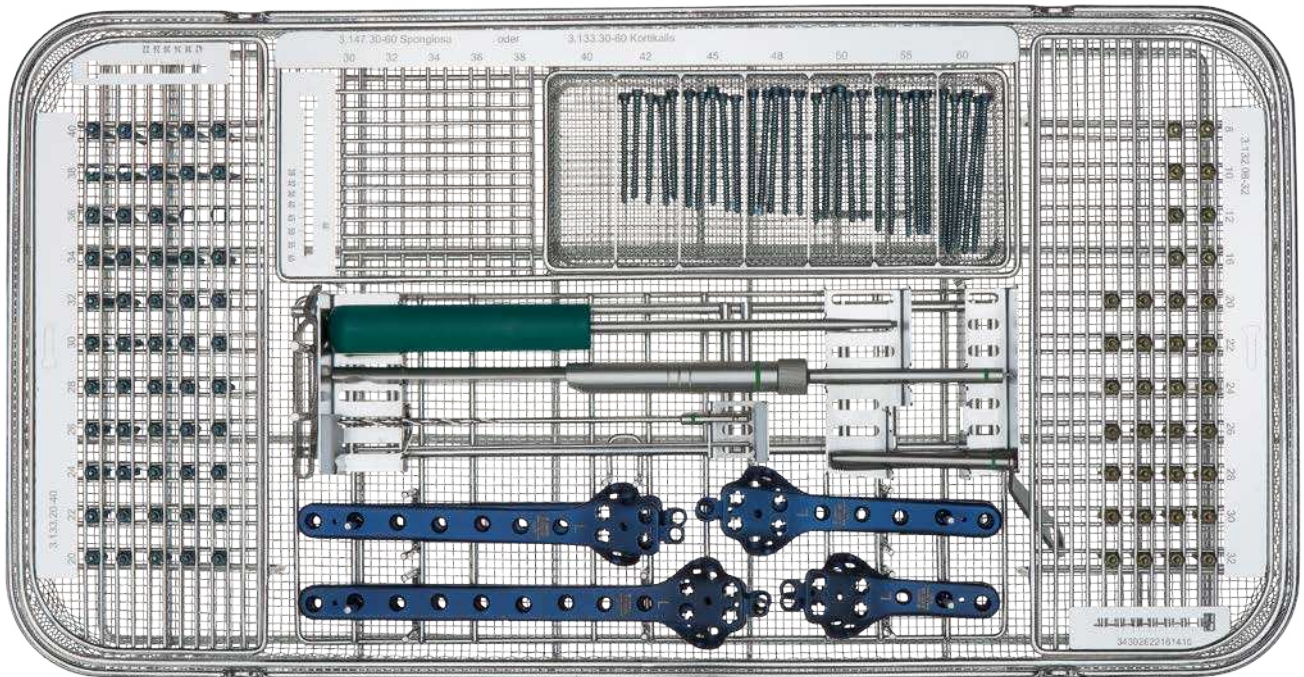
Small Fragment; for Screws \varnothing 3.5 mm; Titanium; Set no. 19.491.00



Set no. 19.491.00  Internal hexagon

Item no.	Item description	Quant.
Implants - screws		
	Cortical screw \varnothing 3.5 mm fully threaded; self tapping; titanium	  Internal hexagon
3.132.08	length 8 mm	2
3.132.10	length 10 mm	2
3.132.12	length 12 mm	2
3.132.16	length 16 mm	2
3.132.20	length 20 mm	4
3.132.22	length 22 mm	4
3.132.24	length 24 mm	4
3.132.26	length 26 mm	4
3.132.28	length 28 mm	4
3.132.30	length 30 mm	4
3.132.32	length 32 mm	4

Set Variable Angle-stable Distal Tibia plate

Small Fragment; for Screws Ø 3.5 mm/4.0 mm; Titanium; Set no. 19.493.00



Item no. 5.732.05



Item no. 5.733.05

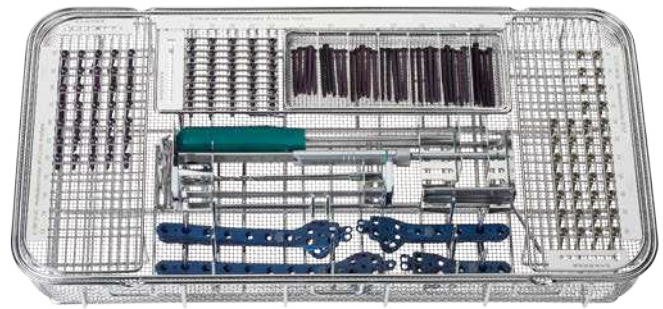

Set no. 19.493.00 Internal hexagon



Item no.	Item description	Quant.
Implants - plates		
Distal Tibia plate with conical thread Ø 3.5 mm medial; variable angle-stable; titanium; right		
5.732.03	3 holes, 76 mm x 14 mm	1
5.732.05	5 holes, 108 mm x 14 mm	1
5.732.07	7 holes, 140 mm x 14 mm	1
5.732.09	9 holes, 172 mm x 14 mm	1

Distal Tibia plate with conical thread Ø 3.5 mm medial; variable angle-stable; titanium; left		
5.733.03	3 holes, 76 mm x 14 mm	1
5.733.05	5 holes, 108 mm x 14 mm	1
5.733.07	7 holes, 140 mm x 14 mm	1
5.733.09	9 holes, 172 mm x 14 mm	1

Instruments		
2.904.22	drill bit for quick coupling; Ø 2.5 mm x 155 mm; spiral length 60 mm, double spiral	1
2.904.25	drill bit for quick coupling; Ø 3.0 mm x 155 mm; spiral length 60 mm, double spiral	1
2.977.16	drill guide for angle stable screwing 4.0, length 68	2
2.977.17	drill guide with handle for variable angle stable screwing 4.0, length 68	1
2.9406.25	hex screwdriver with handle for screws Ø 2.7 mm - Ø 4.0 mm; AF 2.5 mm; conical; PPSU	1
2.953.70	gauge with clasp for screws Ø 3.5 mm; Ø 4.0 mm; measuring range 70 mm	1
2.954.01	screw forceps; self holding	1

Wire		
6.031.18	Kirschner wire with trocar point and round end; Ø 1.8 mm x 150 mm; stainless steel	5

Container		
19.492.00	perforated autoclavable container with inset for instruments and distal tibia plates	1

Item no.	Item description	Quant.
Implants - screws		
Angle-stable cortical screw Ø 4.0 mm; fully threaded; self tapping; titanium		
		
 Internal hexagon		
3.148.20	length 20 mm	5
3.148.22	length 22 mm	5
3.148.24	length 24 mm	5
3.148.26	length 26 mm	5
3.148.28	length 28 mm	5
3.148.30	length 30 mm	5
3.148.32	length 32 mm	5
3.148.34	length 34 mm	5
3.148.36	length 36 mm	5
3.148.38	length 38 mm	5
3.148.40	length 40 mm	5
3.148.42	length 42 mm	5
3.148.44	length 44 mm	5
3.148.46	length 46 mm	5
3.148.48	length 48 mm	5
3.148.50	length 50 mm	5
3.148.52	length 52 mm	5
3.148.54	length 54 mm	5
3.148.56	length 56 mm	5

Set Variable Angle-stable Distal Tibia plate

Small Fragment; for Screws \varnothing 3.5 mm/4.0 mm; Titanium; Set no. 19.493.00

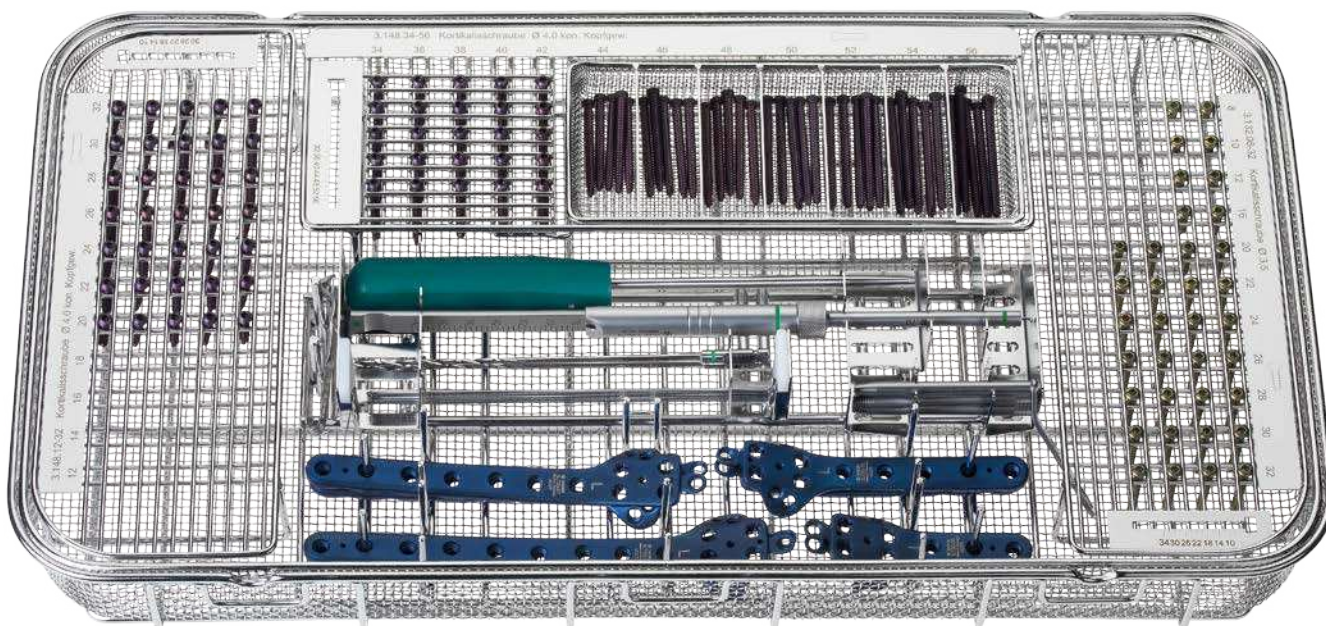

Set no. 19.493.00  Internal hexagon

Item no.	Item description	Quant.
Implants - screws		
	Cortical screw \varnothing 3.5 mm fully threaded; self tapping; titanium 	
3.132.08	length 8 mm	2
3.132.10	length 10 mm	2
3.132.12	length 12 mm	2
3.132.16	length 16 mm	2
3.132.20	length 20 mm	4
3.132.22	length 22 mm	4
3.132.24	length 24 mm	4
3.132.26	length 26 mm	4
3.132.28	length 28 mm	4
3.132.30	length 30 mm	4
3.132.32	length 32 mm	4

Small Fragment Module Distal Medial Tibia Plates

Variable Angle-stable; Titanium; Set no. 19.541.00

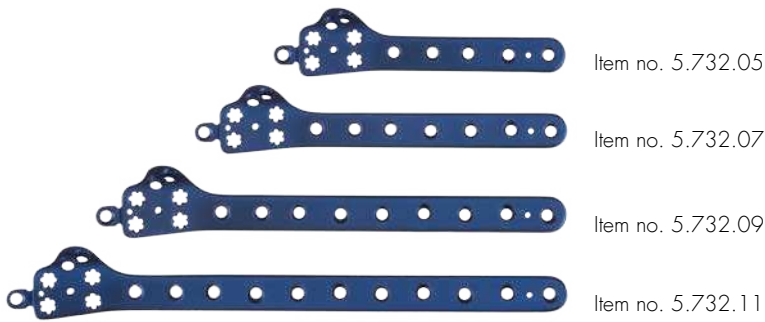

Item no.	Item description	Quant.
Implants - plates		
Distal tibia plate with conical thread Ø 3.5 mm; medial; variable angle-stable; titanium; right		
5.732.05	5 holes; 108 mm x 14 mm	1
5.732.07	7 holes; 140 mm x 14 mm	1
5.732.09	9 holes; 172 mm x 14 mm	1
5.732.11	11 holes; 204 mm x 14 mm	1

Item no.	Item description	Quant.
Container		
19.540.00	Container with inset for implants module tibia	1

Distal tibia plate with conical thread Ø 3.5 mm; medial; variable angle-stable; titanium; left		
5.733.05	5 holes; 108 mm x 14 mm	1
5.733.07	7 holes; 140 mm x 14 mm	1
5.733.09	9 holes; 172 mm x 14 mm	1
5.733.11	11 holes; 204 mm x 14 mm	1

Small Fragment Module Distal Medial Tibia Plates

Variable Angle-stable; Titanium; Set no. 19.541.00



Set no. 19.541.00

FIBULA

Königsee Implantate



Your Partner in Osteosynthesis

VaWiKo® Lateral Distal Fibula Plate 3.5

Variable Angle-stable; Titanium



Item no. 5.07813.06

Item no.	Item description
5.07813.06	VaWiKo® lateral distal Fibula plate 3.5; 4 head holes; 2 shaft holes; length 83 mm
5.07813.07	VaWiKo® lateral distal Fibula plate 3.5; 4 head holes; 3 shaft holes; length 96 mm
5.07813.09	VaWiKo® lateral distal Fibula plate 3.5; 4 head holes; 5 shaft holes; length 122 mm
5.07813.11	VaWiKo® lateral distal Fibula plate 3.5; 4 head holes; 7 shaft holes; length 148 mm

Information:

In Germany the system names VaWiKo® is a Registered Trade Mark.

VaWiKo® is derived from the german designation "Variabel winkelstabile Kombination"; which translates into english as "variable angle-stable combination".

This system combines conventional plating technologies with angle-stable locking in variable angles.

VaWiKo® Lateral Distal Fibula Plate 3.5

Titanium; Set no. 19.474.00/2



Item no. 5.07813.06



Item no. 19.474.00/2

Item no.	Item description	Quant.
Implants - plates		
VaWiKo® lateral distal Fibula plate 3.5; titanium		
5.07813.06	4 head holes; 2 shaft holes; length 83 mm	1
5.07813.07	4 head holes; 3 shaft holes; length 96 mm	1
5.07813.09	4 head holes; 5 shaft holes; length 122 mm	1
5.07813.11	optional: 4 head holes; 7 shaft holes; length 148 mm	1

Instruments		
2.904.06	drill bit for quick coupling; Ø 2.5 mm x 125 mm; spiral length 60 mm; double spiral	1
2.904.10	drill bit for quick coupling; Ø 3.5 mm x 110 mm; spiral length 40 mm; double spiral	1
2.977.12	drill guide with handle for variable angle-stable screwing 3.5 with head Ø 5.0 mm	1
2.977.13	drill guide for angle-stable screws 3.5 with head Ø 5.0 mm; length 44 mm	2
10.520.30	double drill guide Ø 2.5 mm/Ø 3.5 mm; spring bushing	1
2.9406.25	hex screwdriver with handle for screws Ø 2.7 mm up to Ø 4.0 mm; AF 2.5; conical	1
2.953.60	gauge with clasp f.screws with conical head thread Ø 3.5 mm/Ø 4.0 mm; measuring range 60 mm	1
2.924.35	tap for quick coupling for cortical screws; Ø 3.5 mm x 110 mm	1
2.954.01	screw forceps; self holding	1

Accessories		
3.200.02	washer; outside Ø 7.0 mm; inside Ø 3.8 mm; titanium	3

Wire		
6.031.16	Kirschner wire with trocar point and round end; Ø 1.6 mm x 150 mm; stainless steel	5

Container		
19.475.00/2	perforated autoclavable container with inset for instruments and implants variabel angle-stable plates and screws up to 50 mm in length	1

Item no.	Item description	Quant.
Implants - screws		
Angle-stable cortical screws Ø 3.5 mm; fully threaded; self tapping; head 5.0 mm; titanium		
3.136.10	length 10 mm	4
3.136.12	length 12 mm	4
3.136.14	length 14 mm	4
3.136.16	length 16 mm	4
3.136.18	length 18 mm	4
3.136.20	length 20 mm	4
3.136.22	length 22 mm	4
3.136.24	length 24 mm	4



Cortical screws Ø 3.5 mm fully threaded; self tapping; head 5.0 mm; titanium		
3.138.10	length 10 mm	2
3.138.12	length 12 mm	2
3.138.14	length 14 mm	2
3.138.16	length 16 mm	2
3.138.18	length 18 mm	2
3.138.20	length 20 mm	2
3.138.22	length 22 mm	2
3.138.24	length 24 mm	2
3.138.36	length 36 mm	2
3.138.38	length 38 mm	2
3.138.40	length 40 mm	2
3.138.42	length 42 mm	2
3.138.44	length 44 mm	2
3.138.46	length 46 mm	2
3.138.48	length 48 mm	2
3.138.50	length 50 mm	2



VaWiKo® Lateral Distal Fibula Plate 3.5

Titanium; Set no. 19.474.00/2

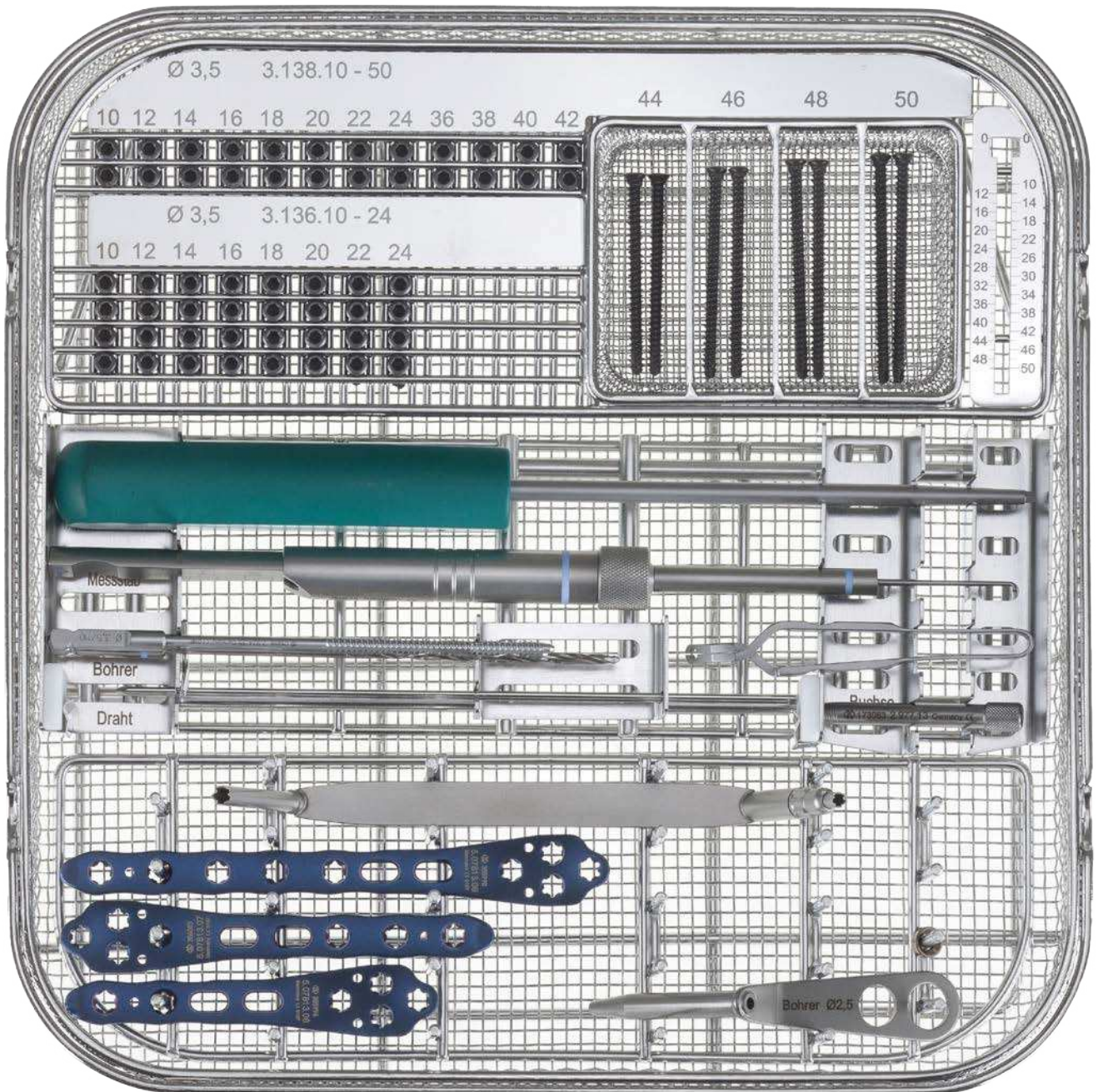

Item no. 19.474.00/2

Information:

In Germany the system names VaWiKo® is a Registered Trade Mark.

VaWiKo® is derived from the german designation "Variabel winkelstabile Kombination"; which translates into english as "variable angle-stable combination". This system combines conventional plating technologies with angle-stable locking in variable angles.



Königsee Implantate

Königsee Implantate GmbH
OF-Aschau / Am Sand 4
07426 Allendorf /Germany
Tel.: +49 36738 498-0
Fax: +49 36738 498-19
Web: www.koenigsee-implantate.de
Mail: info@koenigsee-implantate.de

Variable angle-stable distal fibula plates small fragment; titanium

Item no.	Item description
5.07803.07	Fibula plate with conical thread 3.5 7 holes; 96 x 10 mm
5.07803.09	Fibula plate with conical thread 3.5 9 holes; 122 x 10 mm
5.07803.11	Fibula plate with conical thread 3.5 11 holes; 148 x 10 mm



We hope, this offer meets your expectations
and we would be happy to receive your order.

With kind regards

Königsee Implantate GmbH

Königsee Implantate GmbH

26/08/2013/KaMo

OP-set variable angle-stable distal fibula plates

small fragment, for screws Ø 3.5 mm, titanium, complete set item no.. 19.474.00



fibula plate, 5 holes, 2 long holes
item no.. 5.07803.07

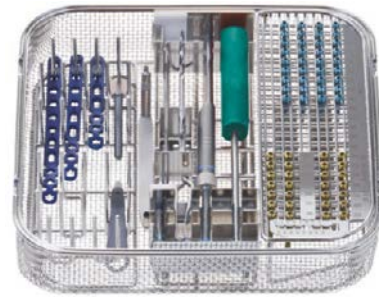

OP-set complete
item no. 19.474.00

item description	item no.	quantity
Implants		
<u>Variable angle-stable distale fibula plates, titanium</u>		
7 holes, 96 x 10 mm	5.07803.07	1
9 holes, 122 x 10 mm	5.07803.09	1
11 holes, 148 x 10 mm	5.07803.11	1

Instruments		
drill bit for quick coupling, Ø 2.5 x 105, spiral length 50, double spiral	2.904.05	1
drill bit for quick coupling, Ø 3.5 x 110, spiral length 40, double spiral	2.904.10	1
drill guide w.handle f.variable angle-stable screwing, SF, length 45	2.977.08	1
drill guide for angle stable screwing, length 45, small fragment	2.977.01	2
drill guide with handle for small fragment, handle length 55	10.500.27A	1
double drill guide Ø 2.5 / Ø 3.5, spring bushing	10.520.30	1
hex screwdriver with handle for screws Ø 2.7-Ø 4.0, AF 2.5, conical	2.9406.25	1
gauge w. clasp f. screws w. con.head thread Ø 3.5,Ø 4.0,MR 60	2.953.60	1
bending lever for reco plates small fragment	2.911.06	2
screw forceps,self holding	2.954.01	1

Container		
perf. autoclavable container w.inset f.instr./impl.angle-stable plate SF	19.475.00/1	1

Wire		
Kirschner wire with trocar point and round end, Ø1.6 x 150, st.st.	6.031.16	5

item description	item no.	quantity
Angle-stable cortical screws		
titanium, fully threaded, self tapping, Ø 3.5 mm		
length 10 mm	3.133.10	4
length 12 mm	3.133.12	4
length 14 mm	3.133.14	4
length 16 mm	3.133.16	4
length 18 mm	3.133.18	4
length 20 mm	3.133.20	4
length 22 mm	3.133.22	4
length 24 mm	3.133.24	4
length 26 mm	3.133.26	4



Cortical screws		
titanium, fully threaded, self tapping, Ø 3.5 mm		
length 10 mm	3.132.10	2
length 12 mm	3.132.12	2
length 14 mm	3.132.14	2
length 16 mm	3.132.16	2
length 18 mm	3.132.18	2
length 20 mm	3.132.20	2
length 22 mm	3.132.22	2
length 24 mm	3.132.24	2
length 26 mm	3.132.26	2
length 28 mm	3.132.28	2
length 30 mm	3.132.30	2
length 34 mm	3.132.34	2
length 36 mm	3.132.36	2
length 38 mm	3.132.38	2



OP-set variable angle-stable distal fibula plates

small fragment, for screws \varnothing 3.5 mm, titanium, complete set item no.. 19.474.00

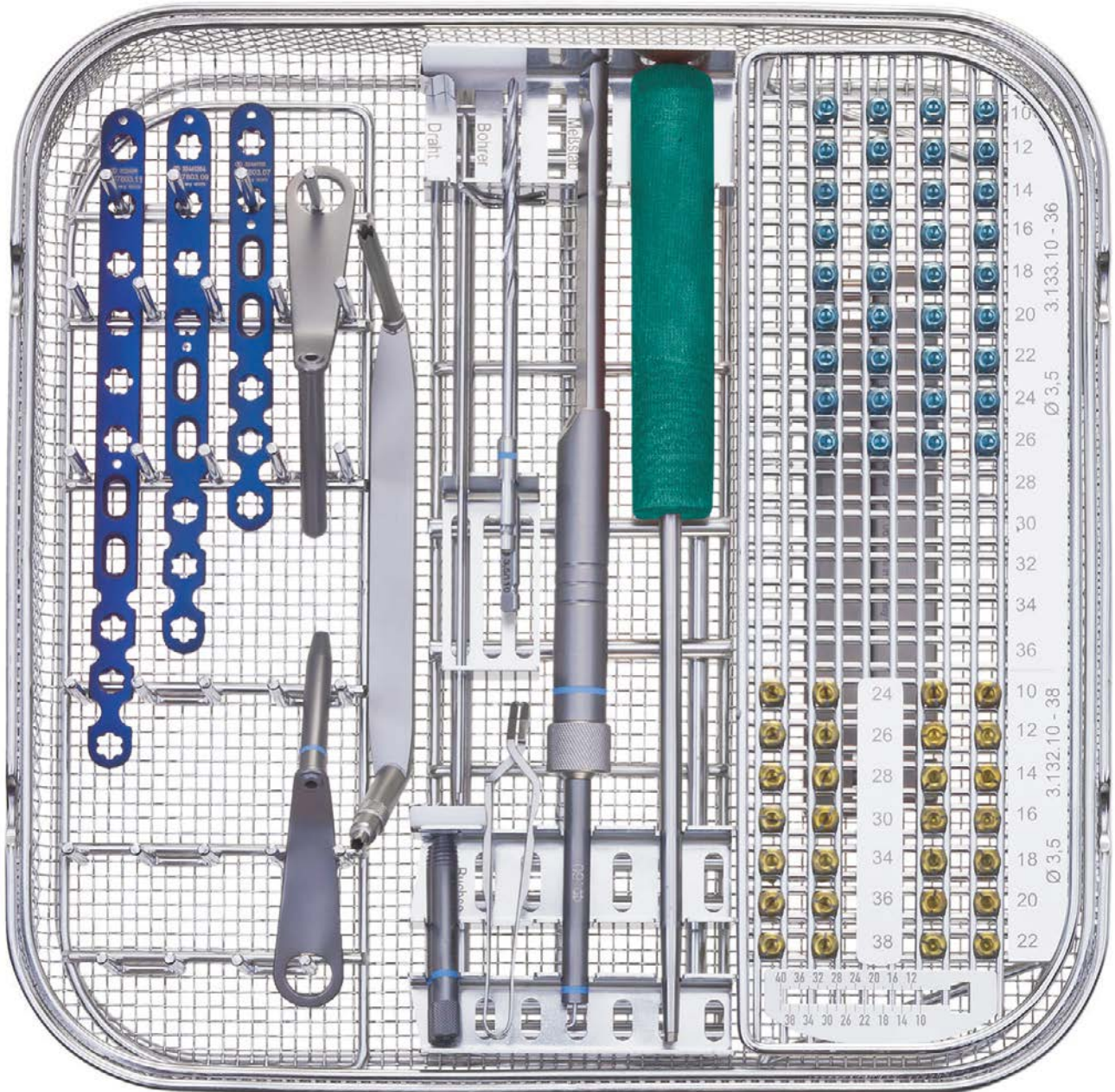

FOOT

Königsee Implantate

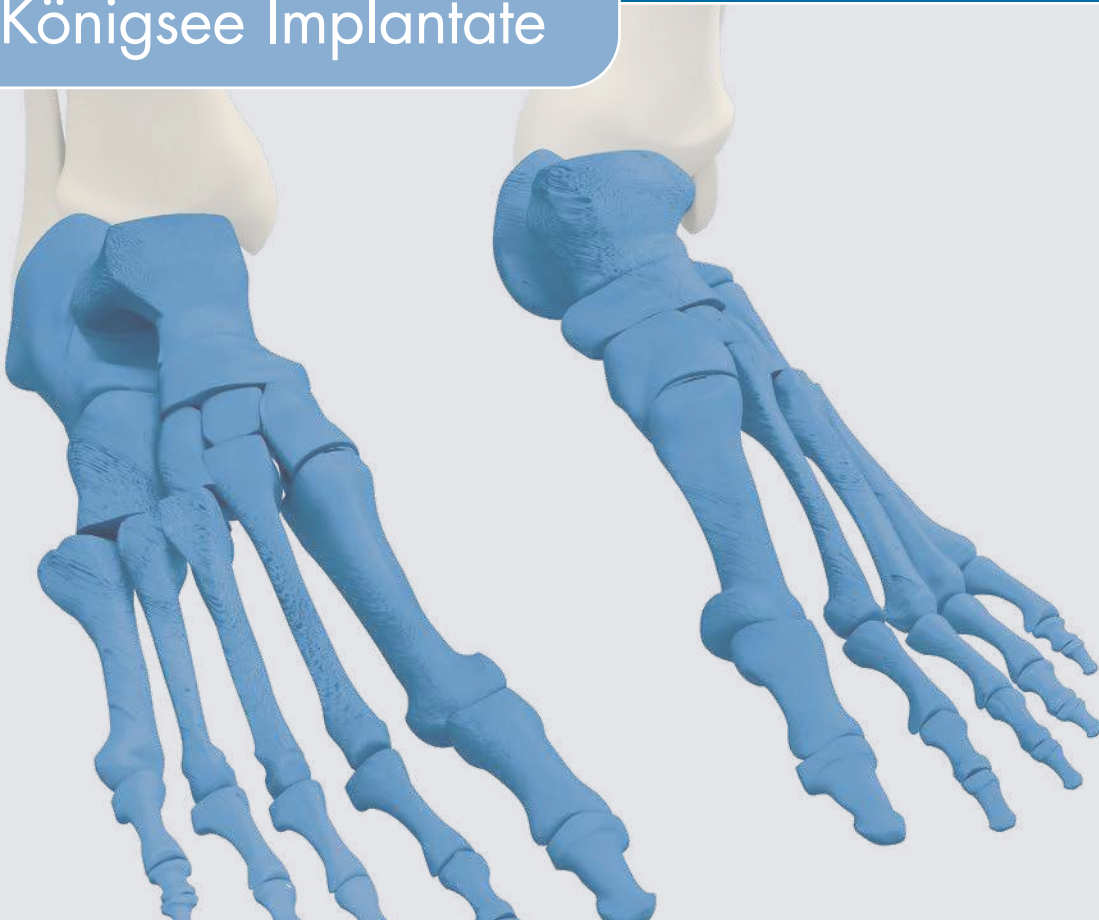

Your Partner in Osteosynthesis

Calcaneus Plates

for Screws \varnothing 3.5 mm; Titanium and Stainless Steel



Item no. 5.862.01



Item no. 5.863.01

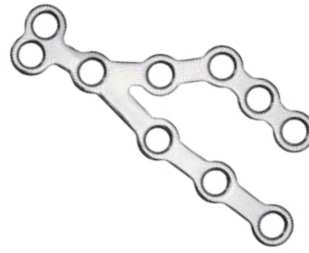

Item no. 4.862.01



Item no. 4.863.01

Item no.	Item description
----------	------------------

Calcaneus plates standard titanium

5.862.01	calcaneus plate 3.5, 10 holes, length 73, big
5.863.01	calcaneus plate 3.5, 8 holes, length 55, small

Calcaneus plates standard stainless steel

4.862.01	calcaneus plate 3.5, 10 holes, length 73, big
4.863.01	calcaneus plate 3.5, 8 holes, length 55, small

Angle-Stable Calcaneus Plates

for Screws \varnothing 3.5 mm and 4.0 mm; Titanium



Item no. 5.878.01



Item no. 5.879.01



Item no. 5.880.01



Item no. 5.881.01

Item no.	Item description
----------	------------------

Angle-stable calcaneus plates

5.878.01	calcaneus plate with conic thread in 3 holes 3.5 and 4.0, 10 holes, big, right, titanium
5.879.01	calcaneus plate with conic thread in 3 holes 3.5 and 4.0, 10 holes, big, left, titanium
5.880.01	calcaneus plate with conic thread in 3 holes 3.5 and 4.0, 8 holes, small, right, titanium
5.881.01	calcaneus plate with conic thread in 3 holes 3.5 and 4.0, 8 holes, small, left, titanium

Set Calcaneus plate 3.5/4.0 as

angle-stable; for screws 3.5/4.0 mm; titanium; Set no. 19.320.00



Item no. 5.878.01



Item no. 5.879.01





Item no. 5.880.01



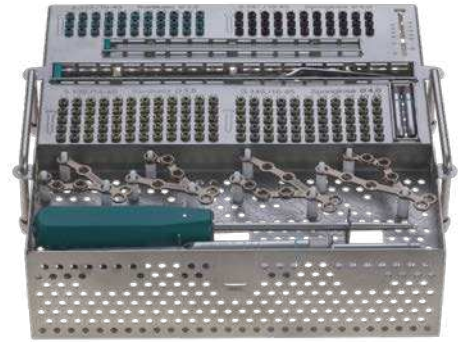



Item no. 5.881.01

Set no. 19.320.00  Internal hexagon

Item no.	Item description	Quant.
Implants – plates		
Calcaneus plate with conical thread in 3 holes; 3.5 and 4.0; large; titanium		
5.878.01	10 holes; right	1
5.879.01	10 holes; left	1
Calcaneus plate with conical thread in 3 holes; 3.5 and 4.0; small; titanium		
5.880.01	8 holes; right	1
5.881.01	8 holes; left	1

Implants – screws		
Cortical screw Ø 3.5 mm; fully threaded; self tapping; titanium 		
 Internal hexagon		
3.132.14	length 14 mm	5
3.132.16	length 16 mm	5
3.132.18	length 18 mm	5
3.132.20	length 20 mm	5
3.132.22	length 22 mm	5
3.132.24	length 24 mm	5
3.132.26	length 26 mm	5
3.132.28	length 28 mm	5
3.132.30	length 30 mm	5
3.132.35	length 35 mm	5
3.132.40	length 40 mm	5
3.132.45	length 45 mm	5

Item no.	Item description	Quant.
Implants – screws		
Cortical screw with conical head thread Ø 3.5 mm; fully threaded; self tapping; titanium 		
 Internal hexagon		
3.133.16	length 16 mm	3
3.133.18	length 18 mm	3
3.133.20	length 20 mm	3
3.133.22	length 22 mm	3
3.133.24	length 24 mm	3
3.133.26	length 26 mm	3
3.133.28	length 28 mm	3
3.133.30	length 30 mm	3
3.133.35	length 35 mm	3
3.133.40	length 40 mm	3
3.133.45	length 45 mm	3

Implants – screws		
Cancellous screw Ø 4.0 mm; fully threaded; titanium 		
 Internal hexagon		
3.145.16	length 16 mm	5
3.145.18	length 18 mm	5
3.145.20	length 20 mm	5
3.145.22	length 22 mm	5
3.145.24	length 24 mm	5
3.145.26	length 26 mm	5
3.145.28	length 28 mm	5
3.145.30	length 30 mm	5
3.145.35	length 35 mm	5
3.145.40	length 40 mm	5
3.145.45	length 45 mm	5

Set Calcaneus plate 3.5/4.0 as

angle-stable; for screws 3.5/4.0 mm; titanium; Set no. 19.320.00

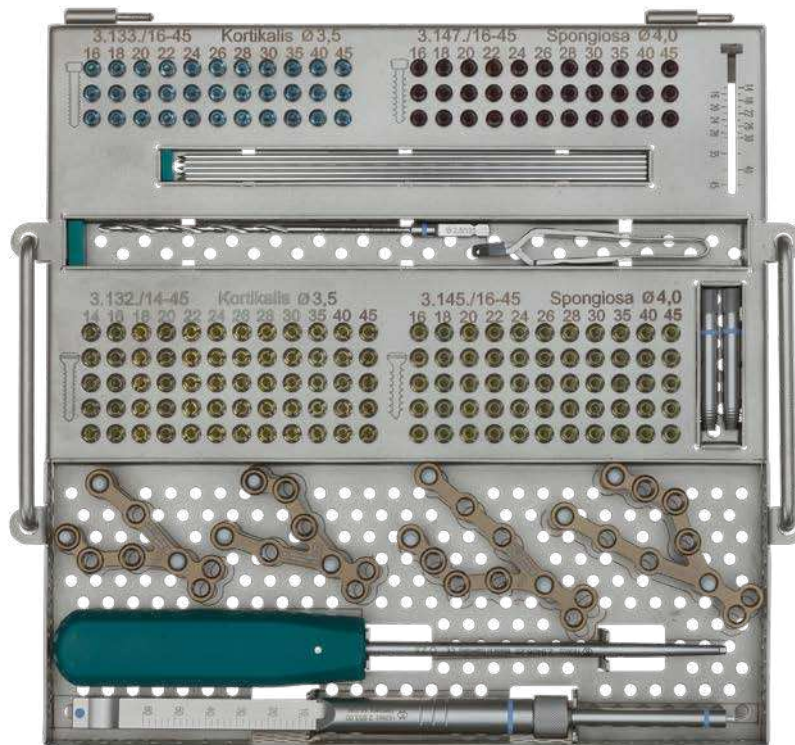

Set no. 19.320.00  Internal hexagon

Item no.	Item description	Quant.
Implants – screws		
Cancellous screw with conical head thread Ø 4.0 mm; fully threaded; self tapping; titanium 		
3.147.16	length 16 mm	3
3.147.18	length 18 mm	3
3.147.20	length 20 mm	3
3.147.22	length 22 mm	3
3.147.24	length 24 mm	3
3.147.26	length 26 mm	3
3.147.28	length 28 mm	3
3.147.30	length 30 mm	3
3.147.35	length 35 mm	3
3.147.40	length 40 mm	3
3.147.45	length 45 mm	3

Wires		
6.031.18	Kirschner wire with trocar point and round end; Ø 1.8 x 150 mm; stainless steel	5

Item no.	Item description	Quant.
Instruments		
2.904.06	drill bit for quick coupling; Ø 2.5 x 125 mm; spiral length 60 mm; double spiral	1
2.9406.25	hex screwdriver with handle for screws Ø 2.7 mm - Ø 4.0 mm; AF 2.5; conical	1
2.953.60	gauge with clasp for screws Ø 3.5 mm; Ø 4.0 mm; measuring range 60 mm	1
2.954.01	screw forceps; self holding	1
2.977.01	drill guide for angle stable screwing; length 45 mm; small fragment	2

Container		
19.321.00	perforated autoclavable container with inset for instruments/implants for calcaneus-set	1

Variable Angle-stable Calcaneus Plates

for Screws \varnothing 3.5 mm and \varnothing 4.0 mm; Titanium

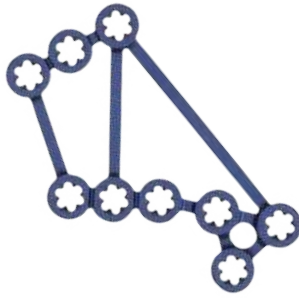

Item no. 5.8793.09

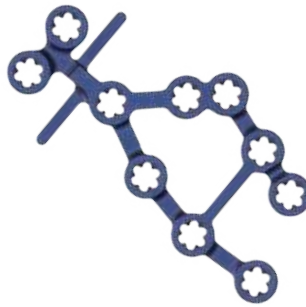

Item no. 5.895.00



Item no. 5.8813.01

Item no.

Item description

Variable angle-stable calcaneus plates

5.8783.09	calcaneus plate with conic thread 3.5 and 4.0, 9 holes, length 65, right, titanium
5.8793.09	calcaneus plate with conic thread 3.5 and 4.0, 9 holes, length 65, left, titanium
5.894.00	calcaneus plate with conic thread 3.5 and 4.0, 10 holes, length 72, right, titanium
5.895.00	calcaneus plate with conic thread 3.5 and 4.0, 10 holes, length 72, left, titanium
5.8803.01	calcaneus plate with conic thread in 3 holes 3.5 and 4.0, 8 holes, angle-stable variable, right, titanium
5.8813.01	calcaneus plate with conic thread in 3 holes 3.5 and 4.0, 8 holes, angle-stable variable, left, titanium

Set Calcaneus Plate 3.5/4.0 vas

variabel angle-stable; for screws 3.5/4.0 mm; titanium; Set no. 19.326.00



Item no. 5.878.01



Item no. 5.879.01

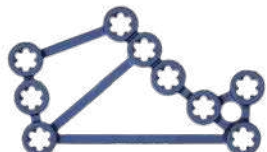

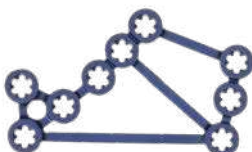

Item no. 5.8783.09







Item no. 5.8793.09

Set no. 19.326.00  Internal hexagon

Item no.	Item description	Quant.
Implants – plates		
Calcaneus plate 3.5/4.0 vas with extension; titanium		
5.894.00	calcaneus plate w. conic thread 3,5 a. 4,0; 10 holes; length 72 mm; vas, right	1
5.895.00	calcaneus plate w. conic thread 3,5 a. 4,0; 10 holes; length 72 mm; vas, left	1
Calcaneus plate 3.5/4.0 vas with bridges; titanium		
5.8783.09	calcaneus plate w. conic thread 3,5 a. 4,0; 9 holes; length 65 mm; vas, right	1
5.8793.09	calcaneus plate w. conic thread 3.5 a. 4.0, 9 holes, length 65 mm, vas, left	1

Item no.	Item description	Quant.
Implants – screws		
Cannulated screw Ø 4.0 mm; thread 14; self drilling, self tapping; back tapping; titanium 		
	 Internal hexagon	
3.440.40	length 40 mm	3
3.440.42	length 42 mm	3
3.440.44	length 44 mm	3
3.440.46	length 46 mm	3
3.440.48	length 48 mm	3
3.440.50	length 50 mm	3
3.440.55	length 55 mm	3

Implants – screws		
Cancellous screw Ø 4.0 mm; fully threaded; titanium 		
	 Internal hexagon	
3.145.22	length 22 mm	3
3.145.26	length 26 mm	3
3.145.30	length 30 mm	3
3.145.35	length 35 mm	3
3.145.40	length 40 mm	3
3.145.45	length 45 mm	3
3.145.50	length 50 mm	3



Implants – screws		
Cortical screw with conical head thread Ø 3.5 mm; fully threaded; self tapping; titanium 		
	 Internal hexagon	
3.133.22	length 22 mm	5
3.133.26	length 26 mm	5
3.133.30	length 30 mm	5
3.133.35	length 35 mm	5
3.133.40	length 40 mm	5
3.133.45	length 45 mm	5
3.133.50	length 50 mm	5

Set Calcaneus Plate 3.5/4.0 vas

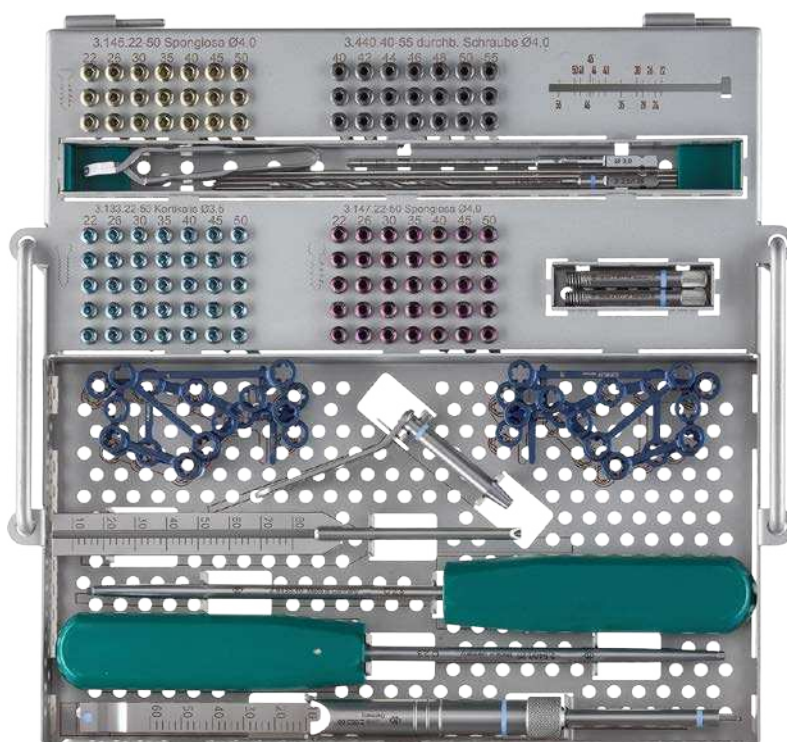
variabel angle-stable; for screws 3.5/4.0 mm; titanium; Set no. 19.326.00



Set no. 19.326.00  Internal hexagon

Item no.	Item description	Quant.
Implants – screws		
	Cancellous screw with conical head thread Ø 3.5 mm; fully threaded; self tapping; titanium	  Internal hexagon
3.147.22	length 22 mm	5
3.147.26	length 26 mm	5
3.147.30	length 30 mm	5
3.147.35	length 35 mm	5
3.147.40	length 40 mm	5
3.147.45	length 45 mm	5
3.147.50	length 50 mm	5

Wires		
6.031.16	Kirschner wire with trocar point and round end, Ø 1.6 x 150 mm, stainless steel	5

Container		
19.325.00	perforated autoclavable container with inset for instruments/implants for calcaneus-set	1

Item no.	Item description	Quant.
Instruments		
2.950.150	gauge for cannulated screws Ø 2.7 - 4.0 mm, L 150 mm	1
2.9436.40	hex screwdriver w. handle for Ø 2.7 - 4.0 mm; cannulated; I Ø 1.7 mm; wrench size 2.5 mm; L 215 mm	1
2.9406.25	hex screwdriver with handle for screws Ø 2.7 - 4.0 mm, AF 2.5, conical	1
2.953.60	gauge with clasp for screws Ø 3.5 mm, Ø 4.0 mm, measuring range 60 mm	1
2.977.08	drill guide w. handle f. variable angle stable screwing, small fragment, length 45 mm	1
2.977.01	drill guide for angle stable screwing, length 45 mm, small fragment	2
2.954.01	screw forceps, self holding	1
2.904.06	drill bit for quick coupling, Ø 2.5 x 125 mm, spiral length 60 mm, double spiral	1
2.906.40	pilot drill bit f.quick coupling, Ø 3.0 x 100 mm, bore length 60 mm, cannulated, I Ø 1.8 mm	1

Hindfoot plates 3.5 holeØ5 vas

variable angle-stable; for screws Ø 3.5 mm; head 5.0; titanium



Item no. 5.2933.02



Item no. 5.2813.23



Item no. 5.2813.28



Item no. 5.2813.28d



Item no. 5.2823.38



Item no. 5.2823.53



Item no. 5.2833.33



Item no. 5.2833.33K

Item no.	Item description	EAN
----------	------------------	-----

VaWiKo® Lapidus Plate 3.5 holeØ5 plantar offset 2 – plate thickness 2.0 mm

5.2923.02 VaWiKo® plantar Lapidus Plate 3.5 offset 2 head 5; right; titanium



5.2933.02 VaWiKo® plantar Lapidus Plate 3.5 offset 2 head 5; left; titanium



Foot plate AD 3.5 holeØ5 vas – plate thickness 2.3 mm

5.2813.23 interposition plate with conical thread 2.7; 4 holes; 23 x 20 mm; variable angle-stable; titanium



5.2813.28d interposition plate with conical thread 2.7; 4 holes; 28 x 20 mm; variable angle-stable; titanium



Foot plate AD-interposition 3.5 holeØ5 vas – plate thickness 2.3 mm

5.2813.28 interposition plate with conical thread 2.7; 5 holes; 28 x 20 mm; variable angle-stable; titanium



5.2813.33 interposition plate with conical thread 2.7; 5 holes; 33 x 20 mm; variable angle-stable; titanium



Multi-AD plate 3.5 holeØ5 vas – plate thickness 2.3 mm

5.2823.38 multi AD-plate with conical thread 2.7; 6 holes; 38 x 20 mm; variable angle-stable; titanium



5.2823.43 multi AD-plate w.conic thread and long bridge 2.7; 6 holes; 43 x 20 mm; var. angle-stable; titanium



5.2823.53 multi AD-plate with conical thread 2.7; 8 holes; 53 x 20 mm; variable angle-stable; titanium



5.2823.68 multi AD-plate with conical thread 2.7; 10 holes; 68 x 20 mm; variable angle-stable; titanium



5.2823.83 multi AD-plate with conical thread 2.7; 12 holes; 83 x 20 mm; variable angle-stable; titanium



T-AD plate 3.5 holeØ5 vas – plate thickness 2.3 mm

5.2833.33 T-AD plate with conical thread 2.7; 2/2holes; 33 x 8 mm; angle stable variable; titanium



5.2833.38 T-AD plate with conical thread 2.7; 2/2holes; 38 x 8 mm; angle stable variable; titanium



T-AD plate 3.5 holeØ5 vas DC – plate thickness 2.3 mm

5.2833.33K T-AD plate with conical thread and 1 DC-hole 2.7; 2/2holes; 33 x 8 mm; var. angle-stable; titanium



5.2833.38K T-AD plate with conical thread and 1 DC-hole 2.7; 2/2holes; 38 x 8 mm; var. angle-stable; titanium



5.2833.43K T-AD plate with conical thread and 1 DC-hole 2.7; 2/3holes; 43 x 8 mm; var. angle-stable; titanium



Hindfoot plates 3.5 holeØ5 vas

variable angle-stable; for screws Ø 3.5 mm; head 5.0; titanium









Item no. 5.2873.33



Item no. 5.2873.43



Item no. 5.2893.74

Item no.	Item description	EAN
LAD plate 3.5 holeØ5 vas skew – plate thickness 2.3 mm		
5.2863.33	LAD plate w.conic thread 2.7; 2/2 holes; 33 x 8 mm; oblique; var. angle-stable; titanium; right	 4 047075 130399
5.2863.43	LAD plate w.conic thread 2.7; 2/3 holes; 43 x 8 mm; oblique; var. angle-stable; titanium; right	 4 047075 130412
5.2873.33	LAD plate w.conic thread 2.7; 2/2 holes; 33 x 8 mm; oblique; var. angle-stable; titanium; left	 4 047075 130436
5.2873.43	LAD plate w.conic thread 2.7; 2/3 holes; 43 x 8 mm; oblique; var. angle-stable; titanium; left	 4 047075 130450
LCF plate 3.5 holeØ5 vas – plate thickness 2.3 mm		
5.2883.74	LCF plate by Köck w.conical thread 2.7; 8 holes; length 74 mm; right; variable angle-stable; titanium	 4 047075 130467
5.2893.74	LCF plate by Köck w.conical thread 2.7; 8 holes; length 74 mm; left; variable angle-stable; titanium	 4 047075 130474

Information

The system name VaWiKo® is derived from the German designation „Variabel winkelstabile Kombination“, which translates into English as „variable angle-stable combination“. This system combines conventional plating technologies with angle-stable locking in variable angles.

VaWiKo® is a registered trademark of Königsee Implantate GmbH.



Königsee Implantate GmbH
OT Aschau | Am Sand 4
07426 Allendorf | Germany

Fon +49 36738 498-560
Fax +49 36738 498-569

Mail export@koenigsee-implantate.de

For further information please visit:
www.koenigsee-implantate.com

DaTi | Edition 03 | 2020-06
All pictured products are CE compliant.

Set Hindfoot plates 3.5 holeØ5 vas

variable angle-stable; titanium; Set no. 19.524.00



Item no. 5.2813.23



Item no. 5.2823.38



Item no. 5.2833.33



Item no. 5.2933.02



Set no. 19.524.00 Internal hexagon

Item no.	Item description	Quant.
Implants – plates		

Foot plate AD 3.5 holeØ5 vas; titanium		
5.2813.23	4 holes; 23 x 20 mm	1

Foot plate AD-interposition 3.5 holeØ5 vas; titanium		
5.2813.33	5 holes; 33 x 20 mm	1

Multi-AD plate 3.5 holeØ5 vas; titanium		
5.2823.38	6 holes; 38 x 20 mm	1
5.2823.53	8 holes; 53 x 20 mm	1
5.2823.83	12 holes; 83 x 20 mm	1

T-AD plate 3.5 holeØ5 vas; titanium		
5.2833.33	2/2 holes; 33 x 8 mm	1

VaWiKo® Lapidus Plate 3.5 holeØ5 plantar offset 2; titanium		
5.2923.02	offset 2; head 5; right	1
5.2933.02	offset 2; head 5; left	1

Implants – screws		
Cortical screw 3.5 head 5; fully threaded; self-tapping; titanium; TiOB®		

3.138.10	length 10 mm	2
3.138.12	length 12 mm	2
3.138.14	length 14 mm	2
3.138.16	length 16 mm	2
3.138.18	length 18 mm	2
3.138.20	length 20 mm	2
3.138.22	length 22 mm	2

Item no.	Item description	Quant.
Implants – screws		

Cortical screw 3.5 head 5; fully threaded; angle-stable; self-tapping; titanium; TiOB®		
---	--	--

3.136.10	length 10 mm	5
3.136.12	length 12 mm	5
3.136.14	length 14 mm	5
3.136.16	length 16 mm	5
3.136.18	length 18 mm	5
3.136.20	length 20 mm	5
3.136.22	length 22 mm	5
3.136.24	length 24 mm	5
3.136.26	length 26 mm	5
3.136.28	length 28 mm	5
3.136.30	length 30 mm	5
3.136.32	length 32 mm	5
3.136.36	length 36 mm	5
3.136.40	length 40 mm	5

Instruments		
2.904.06	drill bit for quick coupling; Ø 2.5 x 125 mm; spiral length 60 mm; double spiral	1
2.9406.25	hex screwdriver with handle for screws Ø 2.7 mm - Ø 4.0 mm, AF 2.5, conical	1
2.953.60	gauge with clasp for screws Ø 3.5 mm; Ø 4.0 mm; measuring range 60	1
2.954.01	screw forceps; self holding	1

Set Hindfoot plates 3.5 holeØ5 vas

variable angle-stable; titanium; Set no. 19.524.00

Item no.	Item description	Quant.
3.138.24	length 24 mm	2
3.138.26	length 26 mm	2
3.138.28	length 28 mm	2
3.138.30	length 30 mm	2
3.138.32	length 32 mm	2
3.138.36	length 36 mm	2
3.138.40	length 40 mm	2

Item no.	Item description	Quant.
2.977.12	drill guide with handle for variable angle stable screwing 3.5 mm with head Ø 5.0 mm	1
2.977.13	drill guide for angle stable screws 3.5 mm with head Ø 5.0 mm; length 44 mm	2

Wires

6.031.10	Kirschner wire with trocar point and round end; Ø 1.0 x 150 mm; stainless steel	5
----------	---	---

Container		
19.521.00	perforated autoclavable container with inset for instruments and hind foot plates 3.5	1



Perforated autoclavable container with screws and instruments and three-part implant insert
Set no. 19.524.00  Internal hexagon

Information

TiOB® is a trademark of Königsee Implantate GmbH registered in the EU countries, Switzerland and the USA. It is a surface treatment that brings optimized properties.



Königsee Implantate GmbH
OT Aschau | Am Sand 4
07426 Allendorf | Germany

Fon +49 36738 498-560
Fax +49 36738 498-569

Mail export@koenigsee-implantate.de

For further information please visit:
www.koenigsee-implantate.com

DaTi | Edition 03 | 2020-06
All pictured products are CE compliant.

Forefoot plates 2.7 vas

variable angle-stable; for screws Ø 2.7 mm; titanium



Item no. 5.2623.27



Item no. 5.2763.28



Item no. 5.2783.28



Item no. 5.2843.18













Item no. 5.2753.46K



Item no. 5.2763.37



Item no. 5.2783.37K

Item no.	Item description	EAN
VaWiKo® T-plate 2.7 – plate thickness 1.5 mm		
5.2623.27	VaWiKo® T-plate 2.7; 2/7 holes; length 73 mm; titanium (Plate can be shortened at tapered points in the shaft)	 4047075169054
Straight plate 2.7 vas – plate thickness 1.5 mm		
5.2843.18	straight plate with conical thread 2.7; 2 holes; 18 x 8 mm; variable angle-stable; titanium	 4047075130290
5.2843.37K	straight plate with conical thread and 1 DC-hole 2.7; 4 holes; 37 x 8 mm; variable angle-stable; titanium	 4047075130351
5.2753.46K	straight plate with conical thread and 2 DC-hole 2.7; 5 holes; 46 x 8 mm; variable angle-stable; titanium	 4047075155170
5.2753.55K	straight plate with conical thread and 2 DC-hole 2.7; 6 holes; 55 x 8 mm; variable angle-stable; titanium	 4047075155187
L-AD plate 2.7 vas – plate thickness 1.5 mm		
5.2763.28	L-AD plate with conical thread 2.7; 2/2 holes; 28 x 8 mm; oblique; variable angle-stable; right; titanium	 4047075131235
5.2763.37	L-AD plate with conical thread 2.7; 2/3 holes; 37 x 8 mm; oblique; variable angle-stable; right; titanium	 4047075131242
5.2773.28	L-AD plate with conical thread 2.7; 2/2 holes; 28 x 8 mm; oblique; variable angle-stable; left; titanium	 4047075131259
5.2773.37	L-AD plate with conical thread 2.7; 2/3 holes; 37 x 8 mm; oblique; variable angle-stable; left; titanium	 4047075131266
T-AD plate 2.7 vas – plate thickness 1.5 mm		
5.2783.28	T-AD plate with conical thread 2.7; 2/2 holes; 28 x 8 mm; variable angle-stable; titanium	 4047075131273
5.2783.37K	T-AD plate with conical thread and 1 DC-hole 2.7; 2/3 holes; 37 x 8 mm; variable angle-stable; titanium	 4047075131280

Information

The system name VaWiKo® is derived from the German designation „Variabel winkelstabile Kombination“, which translates into English as „variable angle-stable combination“. This system combines conventional plating technologies with angle-stable locking in variable angles.

VaWiKo® is a registered trademark of Königsee Implantate GmbH.



Königsee Implantate GmbH
OT Aschau | Am Sand 4
07426 Allendorf | Germany

Fon +49 36738 498-560
Fax +49 36738 498-569

Mail export@koenigsee-implantate.de

For further information please visit:
www.koenigsee-implantate.com

DaTi | Edition 03 | 2019-08
All pictured products are CE compliant.

Forefoot plates 2.7 vas

variable angle-stable; for screws \varnothing 2.7 mm; titanium



Item no. 5.2793.41L



Item no. 5.2793.51L



Item no. 5.2803.18



Item no. 5.2803.37

Item no.	Item description	EAN
MTP plate for arthrodesis 2.7 vas – plate thickness 1.5 mm		
5.2793.41L	MTP plate for arthrodesis with conical thread 2.7; 6 holes; length 41; left; variable angle-stable; titanium	 4047075141753
5.2793.41R	MTP plate for arthrodesis with conical thread 2.7; 6 holes; length 41; right; variable angle-stable; titanium	 4047075141760
5.2793.46L	MTP plate for arthrodesis with conical thread 2.7; 6 holes; length 46; left; variable angle-stable; titanium	 4047075141777
5.2793.46R	MTP plate for arthrodesis with conical thread 2.7; 6 holes; length 46; right; variable angle-stable; titanium	 4047075141784
5.2793.51L	MTP plate for arthrodesis with conical thread 2.7; 8 holes; length 51; left; variable angle-stable; titanium	 4047075141791
5.2793.51R	MTP plate for arthrodesis with conical thread 2.7; 8 holes; length 51; right; variable angle-stable; titanium	 4047075141807
Double bridge plate 2.7 vas – plate thickness 1.6 mm		
5.2803.18	double bridge plate with conical thread 2.7; 4 holes; 16 x 18 mm; variable angle-stable; titanium	 4047075129782
5.2803.20	double bridge plate with conical thread 2.7; 4 holes; 18 x 20 mm; variable angle-stable; titanium	 4047075129720
5.2803.20d	double bridge plate with conical thread 2.7; 4 holes; 18 x 20 mm; variable angle-stable; titanium	 4047075129737
5.2803.22	double bridge plate with conical thread 2.7; 4 holes; 16 x 22 mm; variable angle-stable; titanium	 4047075130221
5.2803.24	double bridge plate with conical thread 2.7; 4 holes; 18 x 24 mm; variable angle-stable; titanium	 4047075129744
5.2803.37	double bridge plate with conical thread 2.7; 8 holes; 16 x 37 mm; variable angle-stable; titanium	 4047075130238

Forefoot plates 2.7 vas

variable angle-stable; for screws Ø 2.7 mm; titanium



Item no. 5.2903.34



Item no. 10.267.60



Item no. 5.2913.22/2



Item no. 5.2913.22/4



Item no. 5.290.03



Item no. 5.2913.22/3



Item no. 5.2913.22/5

Item no.	Item description	EAN
Y-plate 2.7 vas – plate thickness 1.5 mm – supplement forefoot set for spacers		
5.2903.34	Y-plate for spacer with conical thread 2.7; 2/2 holes; 34 x 18 mm; vws; titanium	4047075151332
5.290.02	spacer for foot plates; 8 x 3.5 mm; height 2; titanium	4047075150793
5.290.03	spacer for foot plates; 8 x 3.5 mm; height 3; titanium	4047075150809
5.290.04	spacer for foot plates; 8 x 3.5 mm; height 4; titanium	4047075150816
5.290.05	spacer for foot plates; 8 x 3.5 mm; height 5; titanium	4047075150823
5.290.06	spacer for foot plates; 8 x 3.5 mm; height 6; titanium	4047075150830
10.267.60	holding instrument for spacer for foot plates; Ø12 x 80 mm	4047075159833
18.400.65S30	screw basin for foot plates with spacer; 8 cells	4047075151738
18.015.04S30	cap for screw basin 18.400.65S30	4047075151721

Fore foot step-AD plate 2.7 vas

5.2913.22/2	step-AD plate with conical thread 2.7; 5 holes; 22 x 16 mm; offset 2; variable angle-stable; titanium (Central non angle-stable hole for compression)	4047075155743
5.2913.22/3	step-AD plate with conical thread 2.7; 5 holes; 22 x 16 mm; offset 3; variable angle-stable; titanium (Central non angle-stable hole for compression)	4047075155750
5.2913.22/4	step-AD plate with conical thread 2.7; 5 holes; 22 x 16 mm; offset 4; variable angle-stable; titanium (Central non angle-stable hole for compression)	4047075155767
5.2913.22/5	step-AD plate with conical thread 2.7; 5 holes; 22 x 16 mm; offset 5; variable angle-stable; titanium (Central non angle-stable hole for compression)	4047075155774

Set forefoot plates 2.7 vas

variable angle-stable; for screws \varnothing 2.7 mm; titanium; Set no. 19.523.00



Item no. 5.2803.18



Item no. 5.2803.20d



Item no. 5.2843.18



Item no. 5.2843.37K









Item no. 5.2793.41L

Set no. 19.523.00  Internal hexagon

Item no.	Item description	Quant.
Implants – plates		
5.2803.18	double bridge plate with conical thread 2.7; 4 holes; 16 x 18 mm; variable angle-stable; titanium	1
5.2803.20d	double bridge plate with conical thread 2.7; 4 holes; 18 x 20 mm; variable angle-stable; titanium	1
5.2843.18	straight plate with conical thread 2.7; 2 holes; 18 x 8 mm; variable angle-stable; titanium	1
5.2843.37K	straight plate with conical thread and 1 DC-hole 2.7; 4 holes; 37 x 8 mm; variable angle-stable; titanium	1
5.2793.41R	MTP plate for arthrodesis with conical thread 2.7; 6 holes; ln 41; right; variable angle-stable; titanium	1
5.2793.41L	MTP plate for arthrodesis with conical thread 2.7; 6 holes; ln 41; left; variable angle-stable; titanium	1

Item no.	Item description	Quant.
Instruments		
2.904.04	drill bit for quick coupling; \varnothing 2 x 125; spiral length 30; double spiral	1
2.977.10	drill guide with handle for variable angle stable screwing; mini fragment; length 45	1
2.977.11	drill guide for angle stable screwing 2.7; length 44	2
2.9406.25	hex screwdriver with handle for screws \varnothing 2.7 – \varnothing 4.0; AF 2.5; conical	1
2.953.65	gauge with clasp for screws with conical head thread \varnothing 2.7; measuring range 60	1
2.954.01	screw forceps; self holding	1

Implants – screws		
Cortical screw with conical head thread \varnothing 2.7 mm; fully threaded; self tapping; titanium 		
		 Internal hexagon
3.125.10	length 10 mm	5
3.125.12	length 12 mm	5
3.125.14	length 14 mm	5
3.125.16	length 16 mm	5
3.125.18	length 18 mm	5
3.125.20	length 20 mm	5
3.125.22	length 22 mm	5
3.125.24	length 24 mm	5
3.125.26	length 26 mm	5
3.125.28	length 28 mm	5
3.125.30	length 30 mm	5

Implants – screws		
Cortical screw \varnothing 2.7 mm; fully threaded; self tapping; flat head; titanium 		
		 Internal hexagon
3.128.10	length 10 mm	2
3.128.12	length 12 mm	2
3.128.14	length 14 mm	2
3.128.16	length 16 mm	2
3.128.18	length 18 mm	2
3.128.20	length 20 mm	2
3.128.22	length 22 mm	2
3.128.24	length 24 mm	2
3.128.26	length 26 mm	2
3.128.28	length 28 mm	2
3.128.30	length 30 mm	2

Set forefoot plates 2.7 vas

variable angle-stable; for screws Ø 2.7 mm; titanium; Set no. 19.523.00

Item no.	Item description	Quant.
Wires		
6.031.10	Kirschner wire with trocar point and round end; Ø 1.0 x 150 mm; stainless steel	5

Item no.	Item description	Quant.
Container		
19.520.00	perforated autoclavable container with inset for instruments and fore foot plates 2.7	1

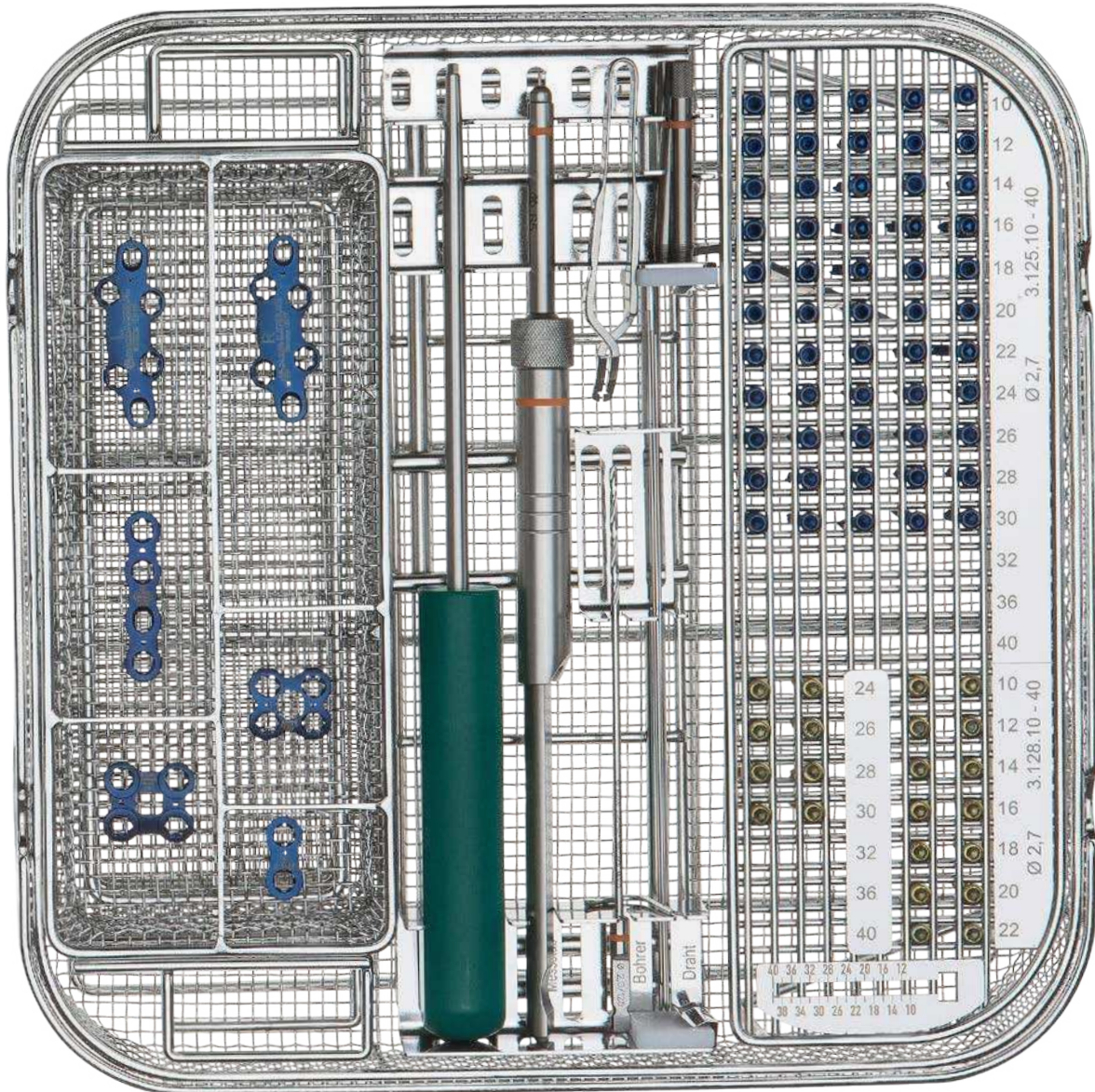

Set no. 19.523.00  Internal hexagon

Set fore footplates 2.7 vas

with six lobe size 10; variable angle-stable; titanium; Set no. 19.5231.00



Item no. 5.2803.18



Item no. 5.2803.20d



Item no. 5.2843.18



Item no. 5.2843.37K







Item no. 5.2793.41L

Set no. 19.5231.00  Six lobe

Item no.	Item description	Quant.
Implants – plates		
5.2803.18	double bridge plate with conical thread 2.7; 4 holes; 16 x 18 mm; variable angle-stable; titanium	1
5.2803.20d	double bridge plate with conical thread 2.7; 4 holes; 18 x 20 mm; variable angle-stable; titanium	1
5.2843.18	straight plate with conical thread 2.7; 2 holes; 18 x 8 mm; variable angle-stable; titanium	1
5.2843.37K	straight plate with conical thread and 1 DC-hole 2.7; 4 holes; 37 x 8 mm; variable angle-stable; titanium	1
5.2793.41R	MTP plate for arthrodesis with conical thread 2.7; 6 holes; In 41; right; variable angle-stable; titanium	1
5.2793.41L	MTP plate for arthrodesis with conical thread 2.7; 6 holes; In 41; left; variable angle-stable; titanium	1

Item no.	Item description	Quant.
Instruments		
2.904.04	drill bit for quick coupling; Ø 2.0 x 125 mm; spiral length 30; double spiral	1
2.9386.10	screwdriver with handle for six-lobe 10	1
2.953.65	gauge with clasp for screws with conical head thread Ø 2.7; measuring range 60	2
2.954.01	screw forceps; self holding	1
2.977.10	drill guide with handle for variable angle-stable screwing; mini fragment; length 45	1
2.977.11	drill guide for angle-stable screwing 2.7; length 44	1

Implants – screws		
Cortical screw with conical head thread Ø 2.7 mm; fully threaded; self tapping; titanium		
		 Six lobe
3.1251.10	length 10 mm	5
3.1251.12	length 12 mm	5
3.1251.14	length 14 mm	5
3.1251.16	length 16 mm	5
3.1251.18	length 18 mm	5
3.1251.20	length 20 mm	5
3.1251.22	length 22 mm	5
3.1251.24	length 24 mm	5
3.1251.26	length 26 mm	5
3.1251.28	length 28 mm	5
3.1251.30	length 30 mm	5

Implants – screws		
Cortical screw Ø 2.7 mm; fully threaded; self tapping; flat head; titanium		
		 Six lobe
3.1281.10	length 10 mm	2
3.1281.12	length 12 mm	2
3.1281.14	length 14 mm	2
3.1281.16	length 16 mm	2
3.1281.18	length 18 mm	2
3.1281.20	length 20 mm	2
3.1281.22	length 22 mm	2
3.1281.24	length 24 mm	2
3.1281.26	length 26 mm	2
3.1281.28	length 28 mm	2
3.1281.30	length 30 mm	2

Set fore footplates 2.7 vas

with six lobe size 10; variable angle-stable; titanium; Set no. 19.5231.00

Item no.	Item description	Quant.
Wires		
6.031.10	Kirschner wire with trocar point and round end; Ø 1.0 x 150 mm; stainless steel	5

Item no.	Item description	Quant.
Container		
19.5201.00	perforated autoclavable container with inset for instruments and fore foot 2.7 with t10	1

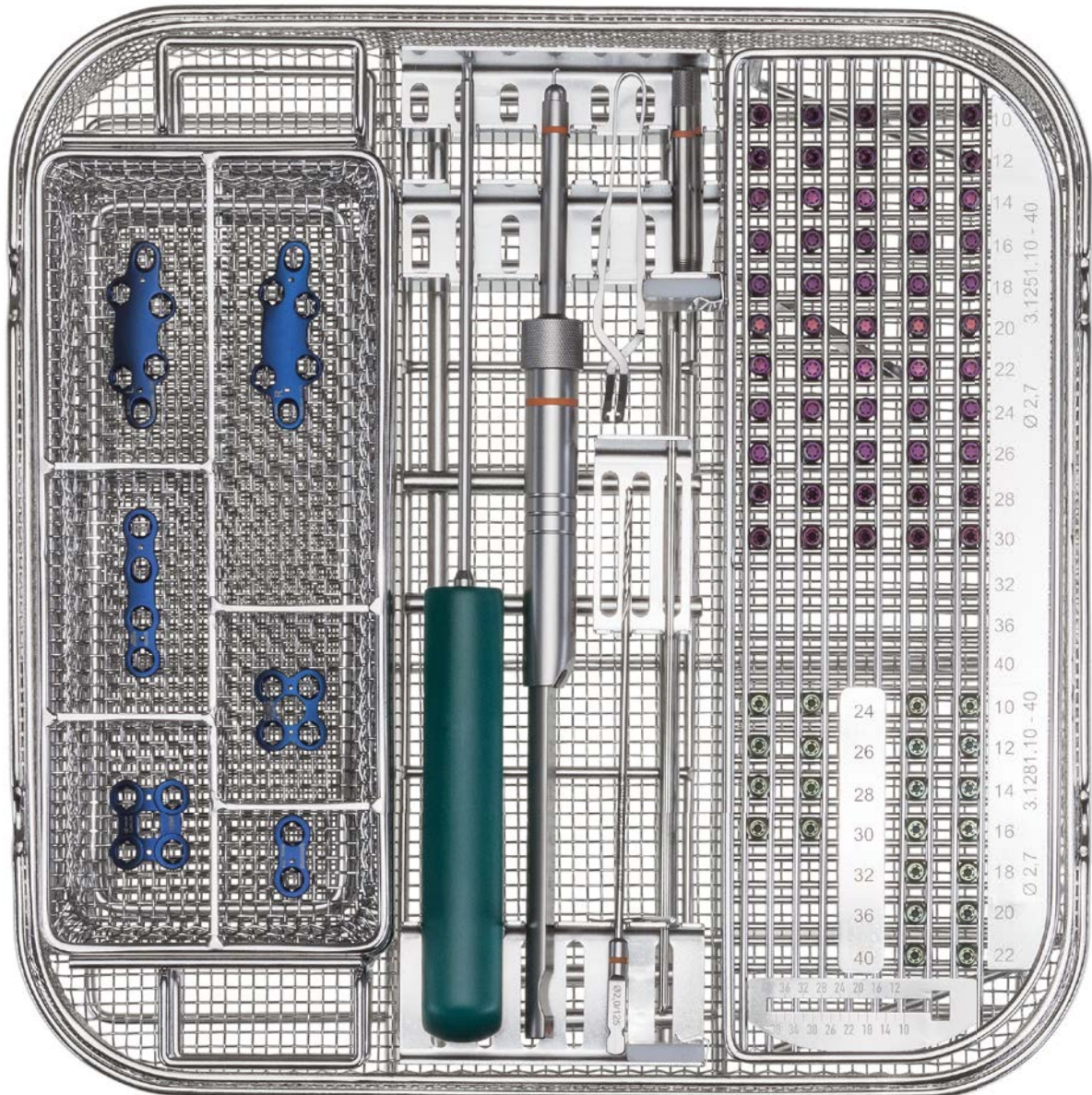

Set no. 19.5231.00  Six lobe

Set Y-Forefoot plate 2.7 with spacer

variable angle-stable; titanium; Set no. 19.523.20



Item no.	Item description	Quant.
Implants – plates		
Y-plate for spacer with conical thread 2.7 mm; variable angle stable; titanium		
5.2903.34	2/2 holes, 34 mm x 18 mm	1

Implants – spacer		
Spacer for foot plates, titanium		
5.290.02	8.0 mm x 3.5 mm; height 2.0 mm	1
5.290.03	8.0 mm x 3.5 mm; height 3.0 mm	1
5.290.04	8.0 mm x 3.5 mm; height 4.0 mm	1
5.290.05	8.0 mm x 3.5 mm; height 5.0 mm	1
5.290.06	8.0 mm x 3.5 mm; height 6.0 mm	1

Item no.	Item description	Quant.
Instruments		
10.267.60	holding instrument for spacer for foot plates, Ø 12 mm x 80 mm	1

Container		
18.400.65S30	screw basin for foot plates with spacer, 8 cells	1
18.015.04S30	cap for screw basin 18.400.65S30	1

Set Y-Forefoot plate 2.7 with spacer

variable angle-stable; titanium; Set no. 19.523.20

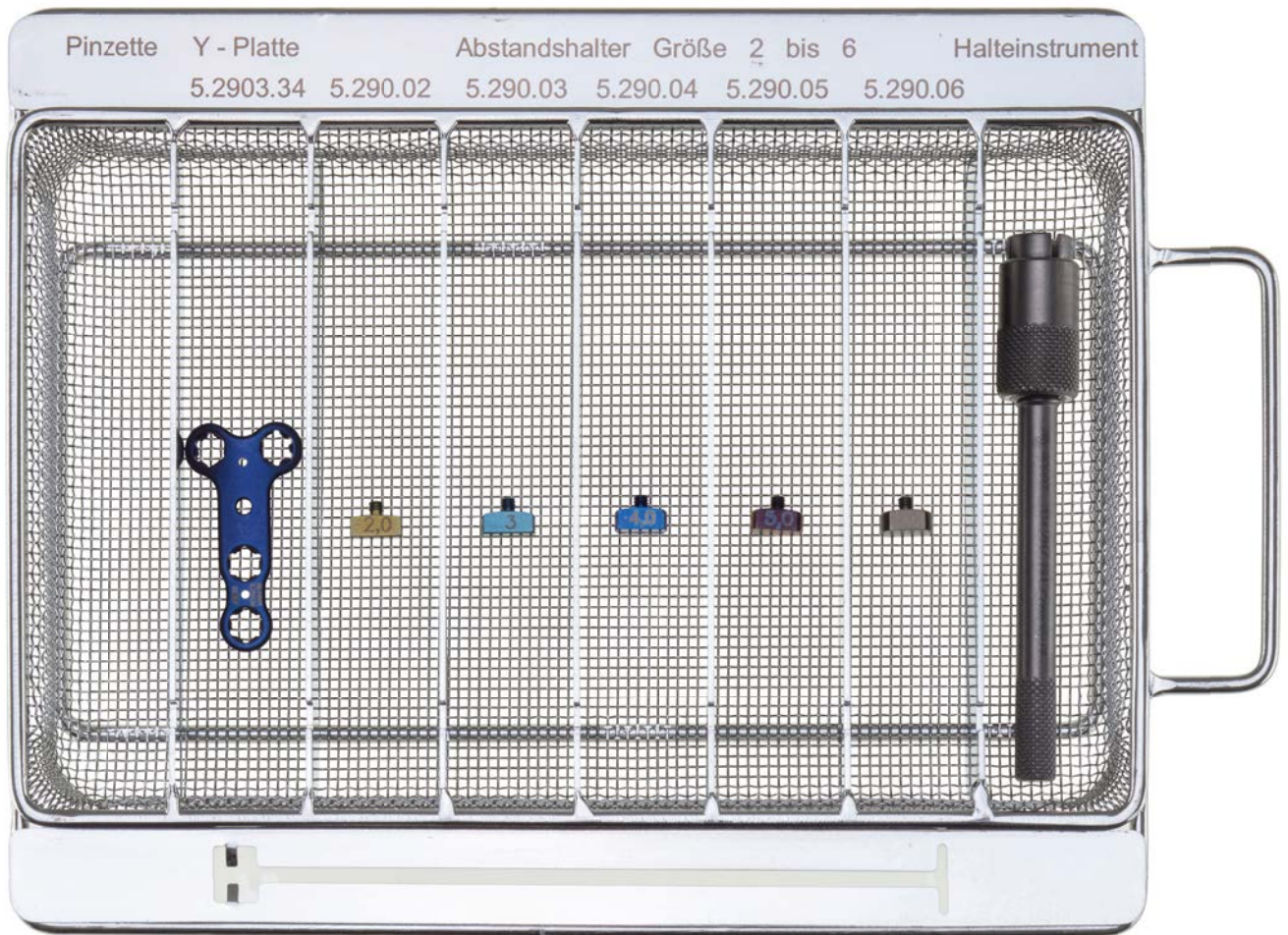

Set no. 19.523.20

Bone clamp



for foot surgery; indented; titanium



Item no. 7.399.08



Item no. 7.399.10

Item no.	Item description	EAN
Bone clamps		
7.399.08	Bone clamp for foot surgery; 8 x 10 mm; indented; titanium	 4 047075 143344
7.399.10	Bone clamp for foot surgery; 10 x 10 mm; indented; titanium	 4 047075 143351

Set instruments for forefoot-surgery

Implants and instruments; several levels; Set no. 19.529.00

LEVEL 1

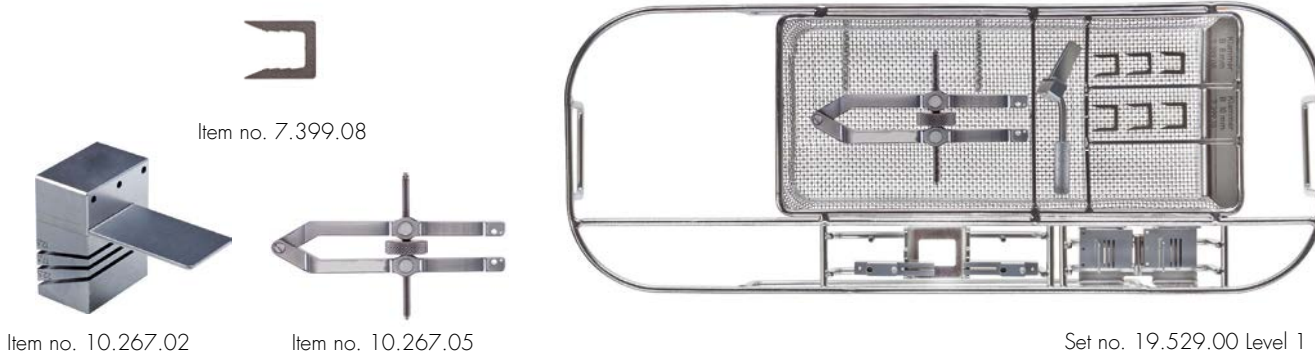

Item no.	Item description	Quant.
Implants – clamps		
7.399.08	bone clamp for hand and foot surgery; 8 x 10 mm; indented; titanium	3
7.399.10	bone clamp for hand and foot surgery; 10 x 10 mm; indented; titanium	3

LEVEL 2

Item no.	Item description	Quant.
Instruments		
2.9103.01	assembly help for hallux cutter concave	1
2.9103.20	hallux cutter set; cutter convex; Ø 20 mm	1
2.9103.22	hallux cutter set; cutter concave; Ø 22 mm	1
2.9103.25	hallux cutter set; cutter convex; Ø 25 mm	1
2.9103.27	hallux cutter set; cutter concave; Ø 27 mm	1
10.267.50	positioning plate; 28 x 225 mm	1
10.507.10	bone lever by Hohmann; 165 x 10 mm; end concave	1
10.267.30	additional impactor for bone clamps 7.399.xx	1
10.267.31	impactor for bone clamps 7.399.xx	1
2.908.13	drill bit with triangular shank; Ø 2.0 x 175 mm; spiral length 60; double spiral	1

Wires		
6.011.10	Kirschner wire with trocar point and round end; Ø 1.0 x 70 mm; stainless steel	5
6.031.18	Kirschner wire with trocar point and round end; Ø 1.8 x 150 mm; stainless steel	5

Item no.	Item description	Quant.
Instruments		
10.267.01	Akin sawing template for angle 10°; 15° and 20°	1
10.267.02	Akin sawing template for angle 12.5°; 17.5° and 22.5°	1
10.267.40	sawing jig for Chevron osteotomy; length saw slit 17.5	1
10.267.05	compression and traction instrument for Akin boring jig	1
10.267.08	Akin boring jig for bone clamp 8 mm	1
10.267.10	Akin boring jig for bone clamp 10 mm	1

Container		
19.528.00	perforated autoclavable container with inset for bone clamps and instruments	1

Set instruments for forefoot-surgery

Implants and instruments; several levels; Set no. 19.529.00

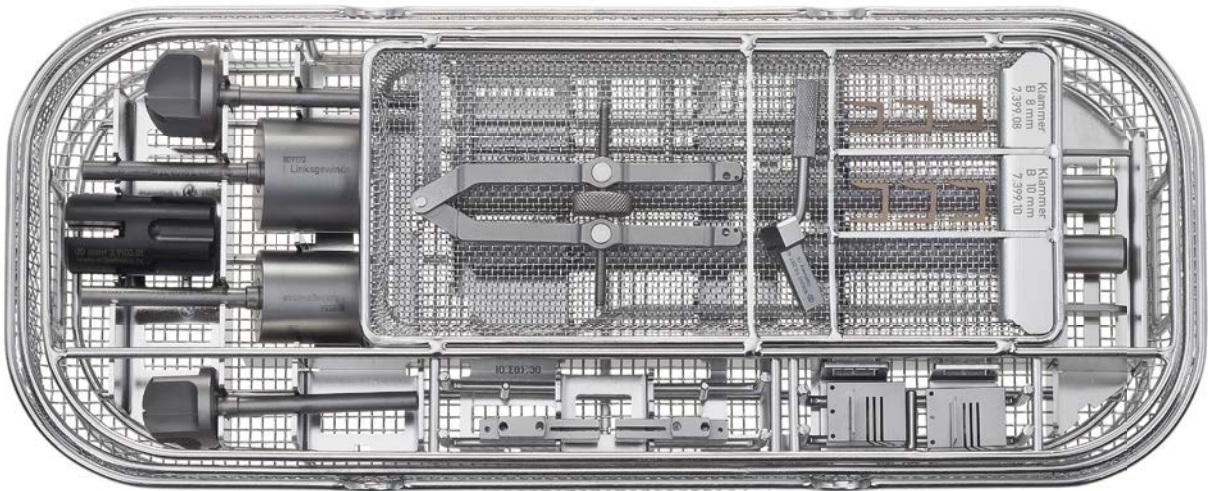

Set no. 19.529.00 Complete

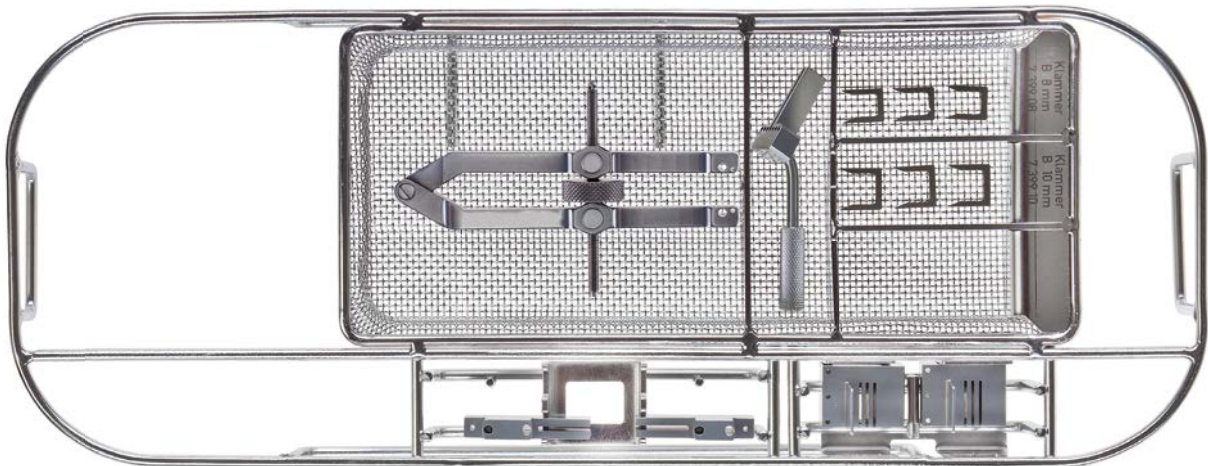

Set no. 19.529.00 Level 1

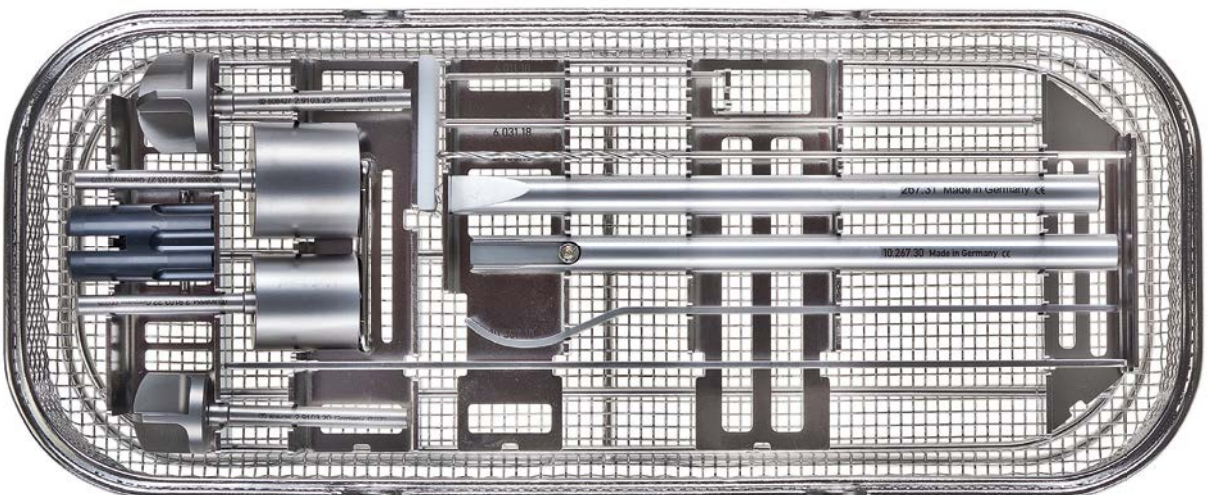

Set no. 19.529.00 Level 2

Fracture Compression Screws and Drill-Fix Forefoot Screws

for Forefoot Treatment / for Dens Screwing; Titanium



Fracture compression screw
Item no. 3.123.20

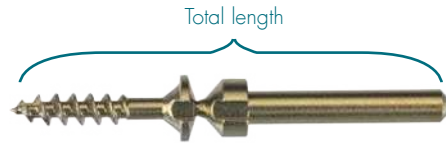

Drill-fix forefoot screw
Item no. 3.127.11

Item no. Item description

Fracture compression screws Ø 3.0 mm / Ø 4.0 mm for forefoot treatment

3.123.10	length 10 mm; thread 4; self drilling; self tapping; cannulated; inside Ø 1.3 mm; titanium
3.123.12	length 12 mm; thread 4; self drilling; self tapping; cannulated; inside Ø 1.3 mm; titanium
3.123.14	length 14 mm; thread 4; self drilling; self tapping; cannulated; inside Ø 1.3 mm; titanium
3.123.16	length 16 mm; thread 6; self drilling; self tapping; cannulated; inside Ø 1.3 mm; titanium
3.123.18	length 18 mm; thread 6; self drilling; self tapping; cannulated; inside Ø 1.3 mm; titanium
3.123.20	length 20 mm; thread 6; self drilling; self tapping; cannulated; inside Ø 1.3 mm; titanium
3.123.22	length 22 mm; thread 6; self drilling; self tapping; cannulated; inside Ø 1.3 mm; titanium
3.123.24	length 24 mm; thread 6; self drilling; self tapping; cannulated; inside Ø 1.3 mm; titanium
3.123.26	length 26 mm; thread 6; self drilling; self tapping; cannulated; inside Ø 1.3 mm; titanium
3.123.28	length 28 mm; thread 6; self drilling; self tapping; cannulated; inside Ø 1.3 mm; titanium
3.123.30	length 30 mm; thread 6; self drilling; self tapping; cannulated; inside Ø 1.3 mm; titanium

Fracture compression screws Ø 3.0 mm / Ø 4.0 mm for dens screwing

3.123.32	length 32 mm; thread 6; self drilling; self tapping; cannulated; inside Ø 1.3 mm; titanium
3.123.34	length 34 mm; thread 6; self drilling; self tapping; cannulated; inside Ø 1.3 mm; titanium
3.123.36	length 36 mm; thread 6; self drilling; self tapping; cannulated; inside Ø 1.3 mm; titanium
3.123.38	length 38 mm; thread 6; self drilling; self tapping; cannulated; inside Ø 1.3 mm; titanium
3.123.40	length 40 mm; thread 6; self drilling; self tapping; cannulated; inside Ø 1.3 mm; titanium
3.123.42	length 42 mm; thread 6; self drilling; self tapping; cannulated; inside Ø 1.3 mm; titanium
3.123.44	length 44 mm; thread 6; self drilling; self tapping; cannulated; inside Ø 1.3 mm; titanium

Drill-fix forefoot screws Ø 2.0 mm

3.127.11	length 11 mm; total length 26 mm; titanium
3.127.12	length 12 mm; total length 27 mm; titanium
3.127.13	length 13 mm; total length 28 mm; titanium
3.127.14	length 14 mm; total length 29 mm; titanium

Set Fracture Compression Screws and Drill-Fix Forefoot Screws

Titanium; Set no. 19.335.00



Fracture compression screw - item no. 3.123.20

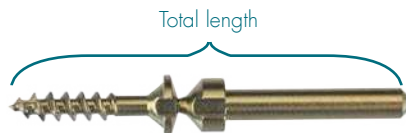

Drill-fix forefoot screw - item no. 3.127.11



Set no. 19.335.00

 Internal hexagon

Item no.	Item description	Quant.
Implants - screws		
Fracture compression screws Ø 3.0 mm / Ø 4.0 mm; self drilling; self tapping; cannulated; inside Ø 1.3 mm; titanium		
3.123.10	length 10 mm; thread 4	3
3.123.12	length 12 mm; thread 4	3
3.123.14	length 14 mm; thread 4	3
3.123.16	length 16 mm; thread 6	3
3.123.18	length 18 mm; thread 6	3
3.123.20	length 20 mm; thread 6	3
3.123.22	length 22 mm; thread 6	3
3.123.24	length 24 mm; thread 6	3
3.123.26	length 26 mm; thread 6	3
3.123.28	length 28 mm; thread 6	3
3.123.30	length 30 mm; thread 6	3

Item no.	Item description	Quant.
Implants - screws		
Drill-fix forefoot screws Ø 2.0 mm; titanium		
3.127.11	length 11 mm; total length 26 mm	3
3.127.12	length 12 mm; total length 27 mm	3
3.127.13	length 13 mm; total length 28 mm	3
3.127.14	length 14 mm; total length 29 mm	3

Instruments		
2.906.30	pilot drill bit for quick coupling with cutter; Ø 2.1 mm x 60 mm; cutter Ø 3.0 mm; cannulated; inside Ø 1.3 mm; short	1
2.906.31	pilot drill bit for quick coupling with cutter; Ø 2.1 mm x 60 mm; cutter Ø 3.0 mm; cannulated; inside Ø 1.3 mm; long	1
2.954.01	screw forceps; self holding	1
2.950.01	gauge for fracture compression screw; length 150 mm; measuring range 40	1
2.940.127	hex screwdriver with handle for drill-fix forefoot screw; HGW	1
2.9436.20	hex screwdriver with handle for fracture compression; cannulated; inside Ø 1.3 mm; wrench size 2; length 215 mm; PPSU	1
10.306.01	handle with quick coupling; length 146 mm; cannulated; inside Ø 2.5 mm; brown handle	1
2.956.42	tissue protecting drill sleeve; Ø 6.0 mm x 30 mm; inside Ø 4.2 mm	1

Wires		
2.982.12	guide wire; Ø 1.2 mm x 150 mm; thread 10; stainless steel	5
6.031.12	Kirschner wire with trocar point and round end; Ø 1.2 mm x 150 mm; stainless steel	3

Container		
19.336.00	perforated autoclavable container with inset for instruments and fracture compression screw	1

Set Fracture Compression Screws and Drill-Fix Forefoot Screws

Titanium; Set no. 19.335.00

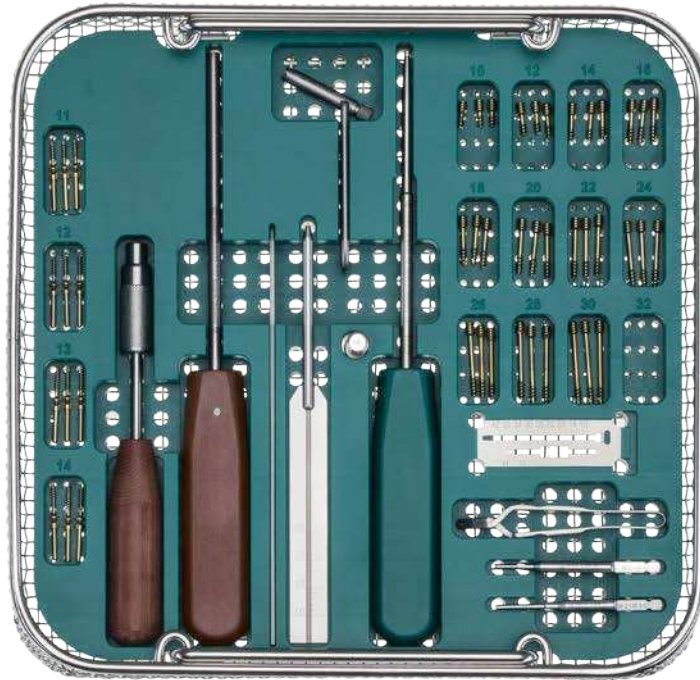

Set no. 19.335.00  Internal hexagon

SPINE

Königsee Implantate

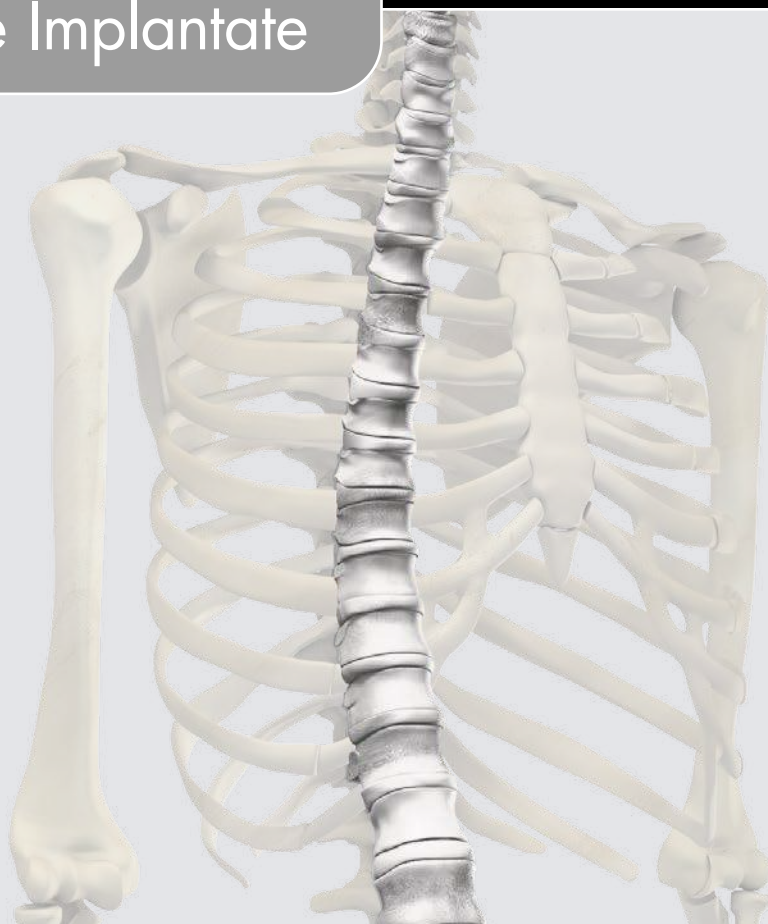

Your Partner in Osteosynthesis

KI-CVA-plates

for screws \varnothing 4.5/5.2 mm; titanium



Item no. 5.555.1624



Item no. 5.555.1640



Item no. 5.555.1652

Item no.	Item description	EAN
5.555.1624	KI-CVA plate 4.5/5.2; 4 holes; 16 x 24 mm	
5.555.1626	KI-CVA plate 4.5/5.2; 4 holes; 16 x 26 mm	
5.555.1628	KI-CVA plate 4.5/5.2; 4 holes; 16 x 28 mm	
5.555.1630	KI-CVA plate 4.5/5.2; 6 holes; 16 x 30 mm	
5.555.1632	KI-CVA plate 4.5/5.2; 6 holes; 16 x 32 mm	
5.555.1634	KI-CVA plate 4.5/5.2; 6 holes; 16 x 34 mm	
5.555.1636	KI-CVA plate 4.5/5.2; 6 holes; 16 x 36 mm	
5.555.1638	KI-CVA plate 4.5/5.2; 6 holes; 16 x 38 mm	
5.555.1640	KI-CVA plate 4.5/5.2; 6 holes; 16 x 40 mm	
5.555.1642	KI-CVA plate 4.5/5.2; 6 holes; 16 x 42 mm	
5.555.1644	KI-CVA plate 4.5/5.2; 6 holes; 16 x 44 mm	
5.555.1646	KI-CVA plate 4.5/5.2; 8 holes; 16 x 46 mm	
5.555.1648	KI-CVA plate 4.5/5.2; 8 holes; 16 x 48 mm	
5.555.1650	KI-CVA plate 4.5/5.2; 8 holes; 16 x 50 mm	
5.555.1652	KI-CVA plate 4.5/5.2; 8 holes; 16 x 52 mm	
5.555.1654	KI-CVA plate 4.5/5.2; 8 holes; 16 x 54 mm	
5.555.1657	KI-CVA plate 4.5/5.2; 8 holes; 16 x 57 mm	
5.555.1660	KI-CVA plate 4.5/5.2; 8 holes; 16 x 60 mm	
5.555.1663	KI-CVA plate 4.5/5.2; 10 holes; 16 x 63 mm	
5.555.1666	KI-CVA plate 4.5/5.2; 10 holes; 16 x 66 mm	
5.555.1669	KI-CVA plate 4.5/5.2; 10 holes; 16 x 69 mm	
5.555.1672	KI-CVA plate 4.5/5.2; 10 holes; 16 x 72 mm	
5.555.1675	KI-CVA plate 4.5/5.2; 10 holes; 16 x 75 mm	

KI-CVA-plates

for screws \varnothing 4.5/5.2 mm; titanium









Item no. 5.555.1624



Item no. 5.555.1640



Item no. 5.555.1652

Item no.	Item description	EAN
5.555.1678	KI-CVA plate 4.5/5.2; 12 holes; 16 x 78 mm	 4 047075 164042
5.555.1681	KI-CVA plate 4.5/5.2; 12 holes; 16 x 81 mm	 4 047075 164059
5.555.1684	KI-CVA plate 4.5/5.2; 12 holes; 16 x 84 mm	 4 047075 164066
5.555.1687	KI-CVA plate 4.5/5.2; 12 holes; 16 x 87 mm	 4 047075 164073
5.555.1690	KI-CVA plate 4.5/5.2; 12 holes; 16 x 90 mm	 4 047075 164080
5.555.1693	KI-CVA plate 4.5/5.2; 14 holes; 16 x 93 mm	 4 047075 164097

Set KI-CVA-plate

for screws Ø 4.5/5.2 mm; titanium; Set no. 19.651.00



Item no. 3.031.12



Item no. 3.033.12



Item no. 5.555.1624



Item no. 5.555.1652

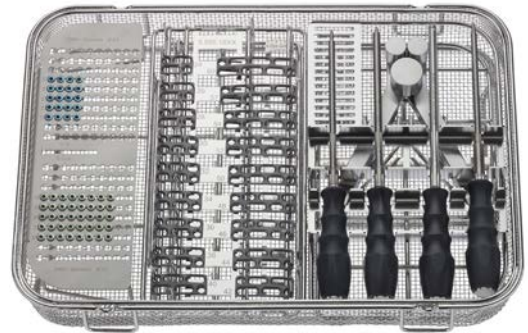

Set no. 19.651.00 six lobe

Item no.	Item description	Quant.
Implants – plates		
KI-CVA-plates for screws Ø 4.5 mm/5.2 mm; titanium		
5.555.1624	4 holes; 16 x 24 mm	1
5.555.1626	4 holes; 16 x 26 mm	1
5.555.1628	4 holes; 16 x 28 mm	1
5.555.1630	6 holes; 16 x 30 mm	1
5.555.1632	6 holes; 16 x 32 mm	1
5.555.1634	6 holes; 16 x 34 mm	1
5.555.1636	6 holes; 16 x 36 mm	1
5.555.1638	6 holes; 16 x 38 mm	1
5.555.1640	6 holes; 16 x 40 mm	1
5.555.1642	6 holes; 16 x 42 mm	1
5.555.1644	6 holes; 16 x 44 mm	1
5.555.1646	8 holes; 16 x 46 mm	1
5.555.1648	8 holes; 16 x 48 mm	1
5.555.1650	8 holes; 16 x 50 mm	1
5.555.1652	8 holes; 16 x 52 mm	1
5.555.1654	8 holes; 16 x 54 mm	1
5.555.1657	8 holes; 16 x 57 mm	1
5.555.1660	8 holes; 16 x 60 mm	1

Item no.	Item description	Quant.
Implants – screws		
Spine screws Ø 4.5 mm; monocortically; titanium		
3.031.12	length 12 mm	8
3.031.14	length 14 mm	8
3.031.16	length 16 mm	8
3.031.18	length 18 mm	8
3.031.20	length 20 mm	8
Spine screws for revision; Ø 5.2 mm; monocortically; titanium		
3.033.12	length 12 mm	4
3.033.14	length 14 mm	4
3.033.16	length 16 mm	4
3.033.18	length 18 mm	4
3.033.20	length 20 mm	4

Instruments		
10.268.51	cone point ball; ball Ø 6.0 mm	1
10.268.52	awl; Ø 2.5 mm; conical	1
10.268.53	screwdriver; six-lobe 10	1
10.268.54	roll-bending plier	1
10.268.06	screwdriver for distraction pins	1
10.268.07	fixation pin Ø 3.5 mm; wrench size 4.0 mm; length 10 mm	5

Container		
19.650.00	perforated autoclavicle container with insert for instruments/implants for KI-CVA-plates	1

Information:

In addition to the standard set KI-CVA-plates up to a length of 93 mm can be ordered for level 2.



Königsee Implantate GmbH
OT Aschau | Am Sand 4
07426 Allendorf | Germany

Fon +49 36738 498-560
Fax +49 36738 498-569

Mail export@koenigsee-implantate.de

For further information please visit:
www.koenigsee-implantate.com

HeBo | Edition 02 | 2019-12
All pictured products are CE compliant.

Set KI-CVA-plate

for screws \varnothing 4.5/5.2 mm; titanium; Set no. 19.651.00

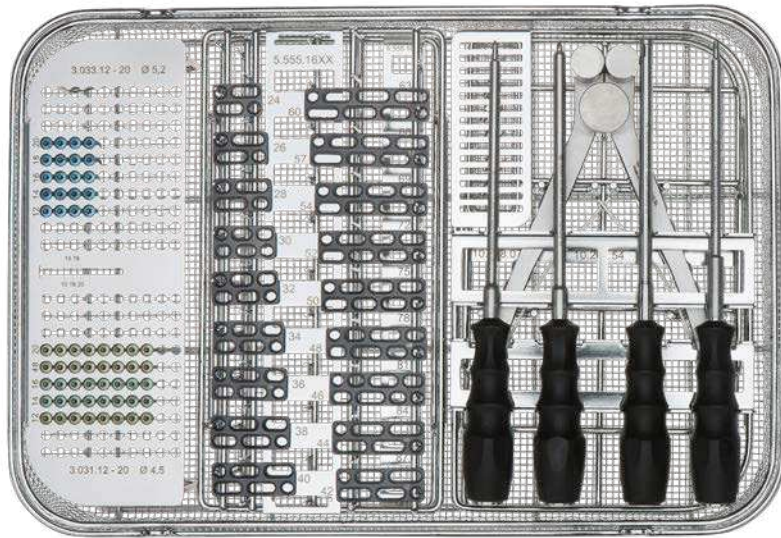

Set no. 19.651.00  six lobe

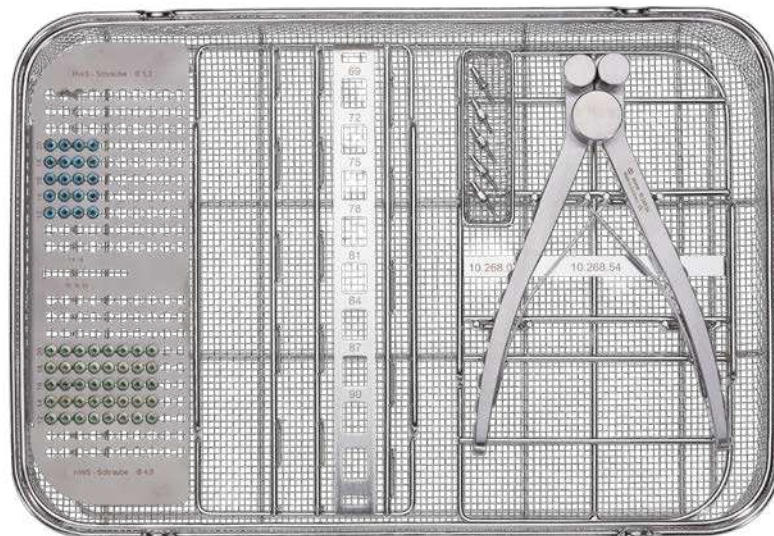

Fracture compressing screw for DENS screwing; titanium

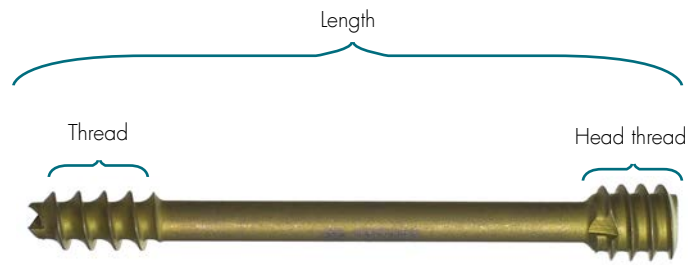

Fracture compressing screw
Item no. 3.123.32

Item no.	Item description	EAN
----------	------------------	-----

Fracture compressing screw Ø 3.0 mm / Ø 4.0 mm for DENS screwing, inner Ø 1.3 mm; titanium

3.123.32	Length 32 mm; Thread 6; selfdrilling; selftapping; cannulated	 4 ⁰ 047075 ⁰ 088805
3.123.34	Length 34 mm; Thread 6; selfdrilling; selftapping; cannulated	 4 ⁰ 047075 ⁰ 088669
3.123.36	Length 36 mm; Thread 6; selfdrilling; selftapping; cannulated	 4 ⁰ 047075 ⁰ 088676
3.123.38	Length 38 mm; Thread 6; selfdrilling; selftapping; cannulated	 4 ⁰ 047075 ⁰ 088683
3.123.40	Length 40 mm; Thread 6; selfdrilling; selftapping; cannulated	 4 ⁰ 047075 ⁰ 088690
3.123.42	Length 42 mm; Thread 6; selfdrilling; selftapping; cannulated	 4 ⁰ 047075 ⁰ 088706
3.123.44	Length 44 mm; Thread 6; selfdrilling; selftapping; cannulated	 4 ⁰ 047075 ⁰ 088560

Set Fracture compressing screw

for DENS screwing; titanium; Set no. 19.380.10

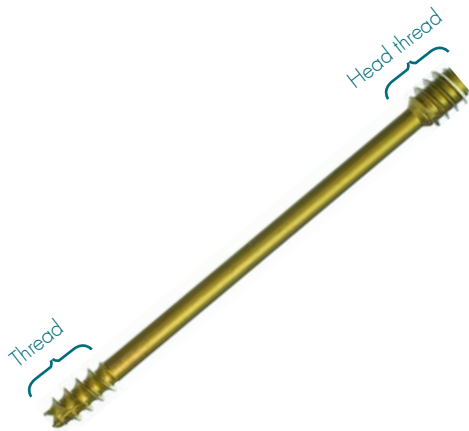

Item no. 3.123.44

Set no. 19.380.10

Internal hexagon

Item no.	Item description	Quant.
Implants - Screws		
Fracture compressing screwn Ø 3.0 mm / Ø 4.0 mm; selfdrilling; selftapping; cannulated; inner Ø 1.3 mm; titanium		
3.123.32	Length 32 mm; Thread 6	2
3.123.34	Length 34 mm; Thread 6	2
3.123.36	Length 36 mm; Thread 6	2
3.123.38	Length 38 mm; Thread 6	2
3.123.40	Length 40 mm; Thread 6	2
3.123.42	Length 42 mm; Thread 6	2
3.123.44	Length 44 mm; Thread 6	2

Item no.	Item description	Quant.
Instruments		
10.266.01	pilot drill with handle, Ø2.1x352, cutter Ø3, cannulated, inside Ø1.3	1
10.266.02	hex screwdriver with handle, wrench width 2, length 350, cannulated, inside Ø1.3	1
10.266.03	double tissue protecting drill sleeve, Ø7x140, inside Ø4.2	1
10.266.034	tubes for double tissue protecting drill sleeve	2
10.266.04	gauge for 10.266.03	1
2.954.01	screw forceps, self holding	1

Wires		
2.984.12/400	guide wire, Ø1.2x400, thread 10, st.st.	5

Container		
19.381.10	perforated autoclavable container with inset for dens screwing	1

Set Fracture compressing screw

for DENS screwing; titanium; Set no. 19.380.10



Set no. 19.380.10

 Internal hexagon

PERIPROSTHETIC

Königsee Implantate

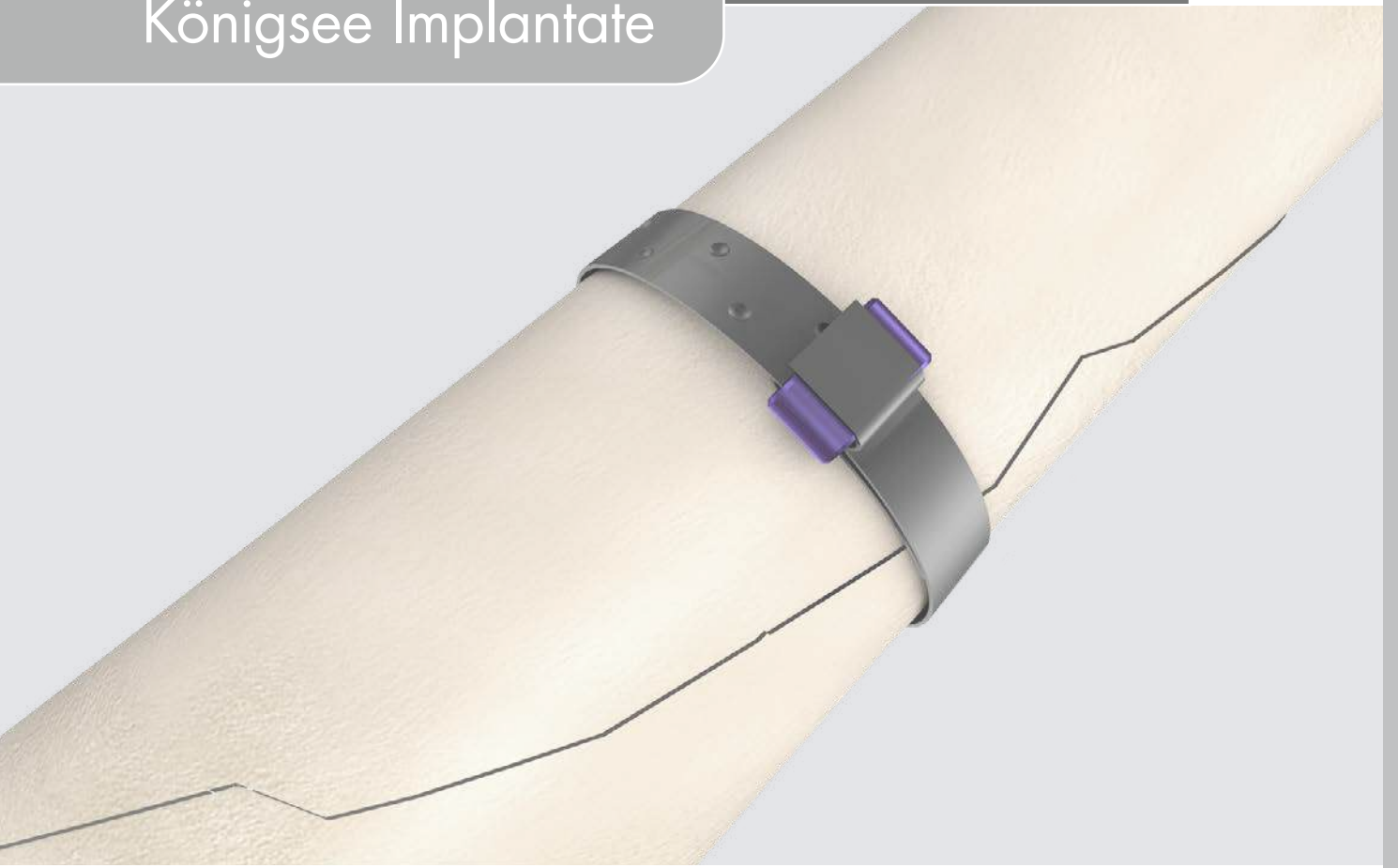

Your Partner in Osteosynthesis

LC-Titanium Strip

with clamp; titanium



Item no. 7.440.01

Item no.	Item description	EAN
7.440.01	LC-titanium strip with clamp; 8.0 mm x 0.4 mm; L 260 mm	 4047075170395

Set LC-Titanium Strip

with clamp; 2 levels; titanium; set-no. 19.519.00



Item no. 10.271.20



Set no. 19.519.00

Item no.	Item description	Quant.
Implants		
LC-titanium strip with clamp		
7.440.01	8.0mmx0.4mm; L 260mm	4

Item no.	Item description	Quant.
Container		
19.519.10	perforated autocl.container w.inset f.instruments for titanium strips	1

Instruments		
10.271.11/65	strip loop instrument; 1/4"-coupling; straight; Ø 65mm; L 225mm	1
10.271.12/65	strip loop instrument; 1/4"-coupling; beveled; Ø 65mm; L 185mm	1
10.271.11/45	strip loop instrument; 1/4"-coupling; straight; Ø 45mm; L 205mm	1
10.271.12/45	strip loop instrument; 1/4"-coupling; beveled; Ø 45mm; L 175mm	1
10.307.03	Handle with 1/4" coupling,length 162	1
10.271.20	universal clamping device f.strips up to 8mmx0.4mm/slopes up to Ø2mm; L220mm	1
10.271.03	pestle f.LC titanium strip 8.0mmx0.4mm; 1/4"-coupling; L 125mm	1
10.271.05	power cutter for LC titanium strip 8.0mmx0.4mm; L 260mm	1
2.975.03	metal hammer,weight 300 g	1

Set LC-Titanium Strip

with clamp; 2 levels; titanium; set-no. 19.519.00

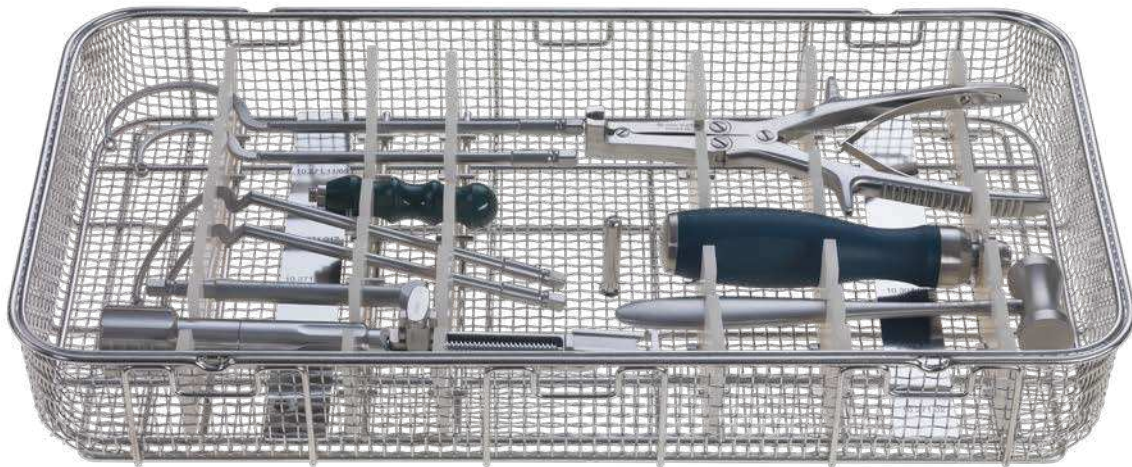

Set no. 19.519.00
2 Level view

CPL-plate

angle-stable; for screws \varnothing 4.5 mm; stainless steel



Item no. 4.2341.10



Item no. 4.2461.10

Item no.	Item description	EAN
CPL-plate with 2 DC-holes; 12 mm wide; stainless steel		
4.2341.08	CPL-plate with conical thread 4.5; 6 notches; 8 holes; 124 x 12 mm; stainless steel	4 047075 149575
4.2341.10	CPL-plate with conical thread 4.5; 8 notches; 10 holes; 154 x 12 mm; stainless steel	4 047075 149582
4.2341.12	CPL-plate with conical thread 4.5; 10 notches; 12 holes; 184 x 12 mm; stainless steel	4 047075 149599
4.2341.14	CPL-plate with conical thread 4.5; 12 notches; 14 holes; 214 x 12 mm; stainless steel	4 047075 149605
CPL-plate with 2 DC-holes; 16 mm wide; stainless steel		
4.2461.10	CPL-plate with conical thread 4.5; 8 notches; 10 holes; 174 x 16 mm; stainless steel	4 047075 145157
4.2461.12	CPL-plate with conical thread 4.5; 10 notches; 12 holes; 206 x 16 mm; stainless steel	4 047075 145164
4.2461.14	CPL-plate with conical thread 4.5; 12 notches; 14 holes; 238 x 16 mm; stainless steel	4 047075 145171
4.2461.16	CPL-plate with conical thread 4.5; 14 notches; 16 holes; 270 x 16 mm; stainless steel	4 047075 145188

Set CPL-plate

angle-stable; stainless steel; Set no. 19.516.00



Item no. 4.2341.10



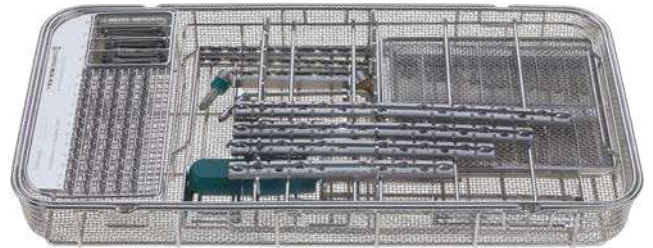

Item no. 4.2461.10



Set no. 19.516.00  Internal hexagon

Item no.	Item description	Quant.
Implants – plates		
CPL-plate w. con. thread; 2 DC-holes; f. screws Ø 4.5 mm; stainl. steel		
4.2341.08	6 notches; 8 holes; 124 x 12 mm	1
4.2341.10	8 notches; 10 holes; 154 x 12 mm	1
4.2341.12	10 notches; 12 holes; 184 x 12 mm	1
4.2341.14	12 notches; 14 holes; 214 x 12 mm	1
4.2461.10	8 notches; 10 holes; 174 x 16 mm	1
4.2461.12	10 notches; 12 holes; 206 x 16 mm	1
4.2461.14	12 notches; 14 holes; 238 x 16 mm	1
4.2461.16	14 notches; 16 holes; 270 x 16 mm	1

Item no.	Item description	Quant.
Implants – screws		
Cortical screw Ø 4.5 mm; fully threaded; self tapping; stainless steel		
 Internal hexagon		
2.152.12	length 12 mm	3
2.152.14	length 14 mm	3
2.152.16	length 16 mm	3
2.152.22	length 22 mm	4
2.152.24	length 24 mm	4
2.152.26	length 26 mm	4
2.152.28	length 28 mm	4
2.152.30	length 30 mm	4
2.152.32	length 32 mm	4
2.152.34	length 34 mm	4
2.152.36	length 36 mm	4
2.152.38	length 38 mm	4
2.152.40	length 40 mm	4
2.152.42	length 42 mm	4

Item no.	Item description	Quant.
Implants – screws		
Cortical screw Ø 4.5 mm; conical head thread; fully threaded; self tapping; stainless steel		
 Internal hexagon		
2.545.18	length 18 mm	5
2.545.20	length 20 mm	5
2.545.22	length 22 mm	5
2.545.24	length 24 mm	5
2.545.26	length 26 mm	5
2.545.28	length 28 mm	5
2.545.30	length 30 mm	5
2.545.32	length 32 mm	5
2.545.34	length 34 mm	5
2.545.36	length 36 mm	5
2.545.38	length 38 mm	5
2.545.40	length 40 mm	5
2.545.42	length 42 mm	5
2.545.45	length 45 mm	5
2.545.50	length 50 mm	5
2.545.55	length 55 mm	5

Set CPL-plate

angle-stable; stainless steel; Set no. 19.516.00

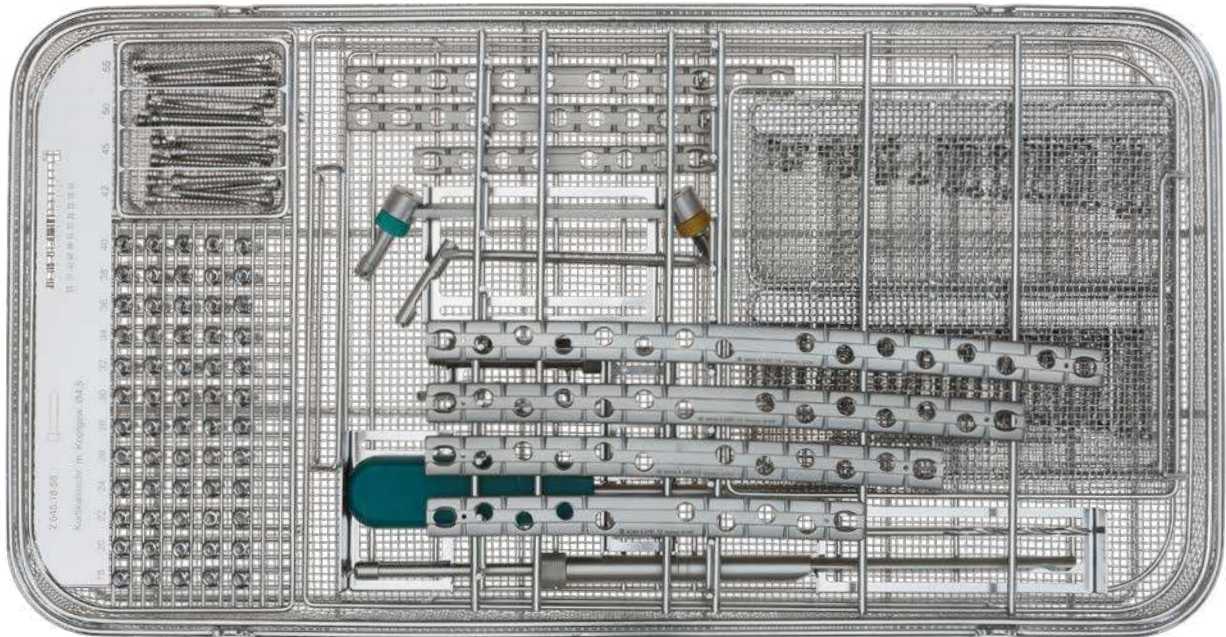

Set no. 19.516.00  Internal hexagon

Item no.	Item description	Quant.
Instruments		
2.9406.35	hex screwdriver with handle for screws Ø 4.5 mm - Ø 7.0 mm, AF 3.5 mm, length 215 mm	1
2.904.09	drill bit for quick coupling, Ø 3.2 x 195 mm, spiral length 60 mm, double spiral	1
2.977.02	drill guide for angle stable screwing, length 70 mm, big fragment	2
10.500.21	drill guide for neutral and compression position, Ø 3.2 mm	1
10.502.32	universal drill guide, Ø 3.2 mm	1
2.953.90	gauge with clasp for screws Ø 4.5 mm, Ø 6.0 mm, measuring range 90 mm	1
2.954.01	screw forceps, self holding	1

Item no.	Item description	Quant.
Container		
19.515.00	perforated autoclavable container with inset for instruments and CPL-plates	1

Cables

for cable osteosynthesis CPL; Ø 1.0 mm and Ø 1.5 mm; with and without eyelet; stainless steel



Item no. 6.409.10/150



Item no. 6.409.10/500







Item no. 6.409.15/500



Item no. 6.409.P10



Item no. 6.409.P15

Item no.	Item description	EAN
Cables Ø 1.0 mm and ferrules		
6.409.10/150	cable with ear for cable osteosynthesis; Ø 1.0 x 150 mm; stainless steel	
6.409.10/500	cable for cable osteosynthesis; Ø 1.0 x 500 mm; laser welded on both sides; stainless steel	
6.409.P10	ferrule for cable Ø 1.0 mm; stainless steel	
Cable Ø 1.5 mm and ferrules		
6.409.15/500	cable for CPL; Ø 1.5 x 500 mm; laser welded on both sides; stainless steel	
6.409.P15	ferrule for cable Ø 1.5 mm; stainless steel	

Set Cable plate osteosynthesis 1.0

by Prof. Labitzke; stainless steel; Set no. 19.518.00



Item no. 6.409.10/150



Item no. 6.409.10/500



Item no. 6.409.P10

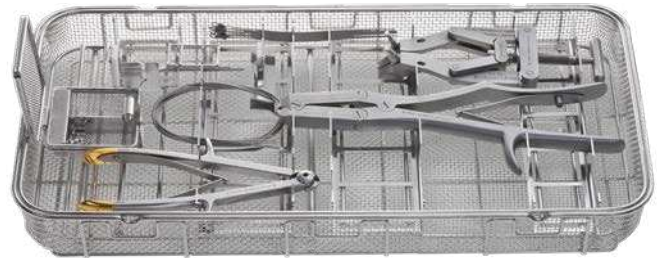

Set no. 19.518.00

Item no.	Item description	Quant.
Implants – cable		
6.409.10/150	cable with ear for cable osteosynthesis, Ø 1.0 x 150 mm, stainless steel	10
6.409.10/500	cable for cable osteosynthesis, Ø 1.0 x 500 mm, laser welded on both sides, stainless steel	10
6.409.P10	ferrule for cable Ø 1.0 mm, stainless steel	20

Item no.	Item description	Quant.
Container		
19.517.00	perforated autoclavable container with inset for instruments for cable plate osteosynthesis	1

Instruments		
10.265.01	awl, bent	1
10.265.02	awl, straight	1
10.265.05	cable cutter	1
10.265.06	rope retainer	1
10.265.10	ferrule forceps for cable Ø 1.0 mm	1

Set Cable plate osteosynthesis 1.0

by Prof. Labitzke; stainless steel; Set no. 19.518.00

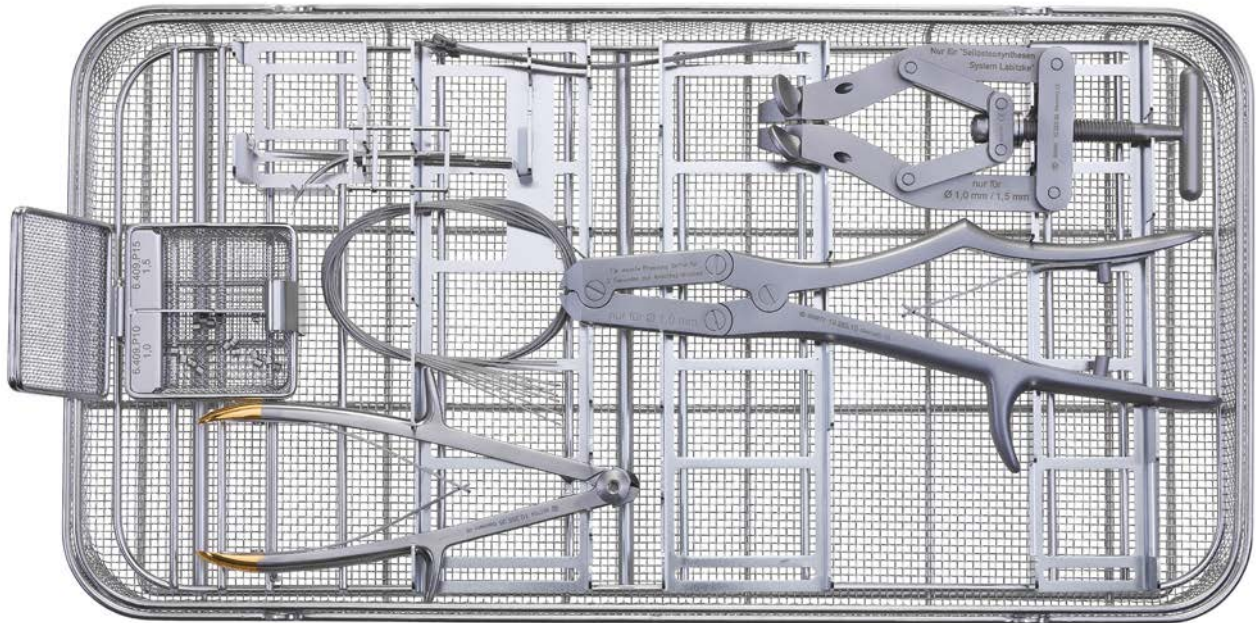

Set no. 19.518.00

Set Cable plate osteosynthesis 1.5

by Prof. Labitzke; stainless steel; Set no. 19.518.00/1



Item no. 6.409.15/500



Item no. 6.409.P15

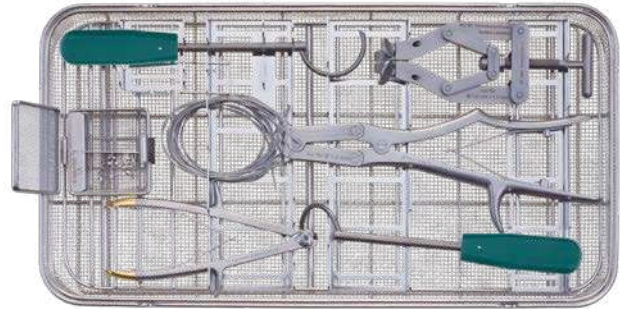

Set no. 19.518.00/1

Item no.	Item description	Quant.
Implants – cable		
6.409.15/500	cable for cable osteosynthesis, Ø 1.5 x 500 mm, laser welded on both sides, stainless steel	10
6.409.P15	ferrule for cable Ø 1.5 mm, stainless steel	20

Item no.	Item description	Quant.
Container		
19.517.00/1	perforated autoclavable container with inset for instruments for cable plate osteosynthesis 1.5	1

Instruments		
10.2656.04/50	loop instrument for cable, straight, Ø 50 mm	1
10.2656.03/50	loop instrument for cable, 120° angled; Ø 50 mm	1
10.265.05	cable cutter	1
10.265.06	rope retainer	1
10.265.15	ferrule forceps for cable Ø 1.5 mm	1

Set Cable plate osteosynthesis 1.5

by Prof. Labitzke; stainless steel; Set no. 19.518.00/1

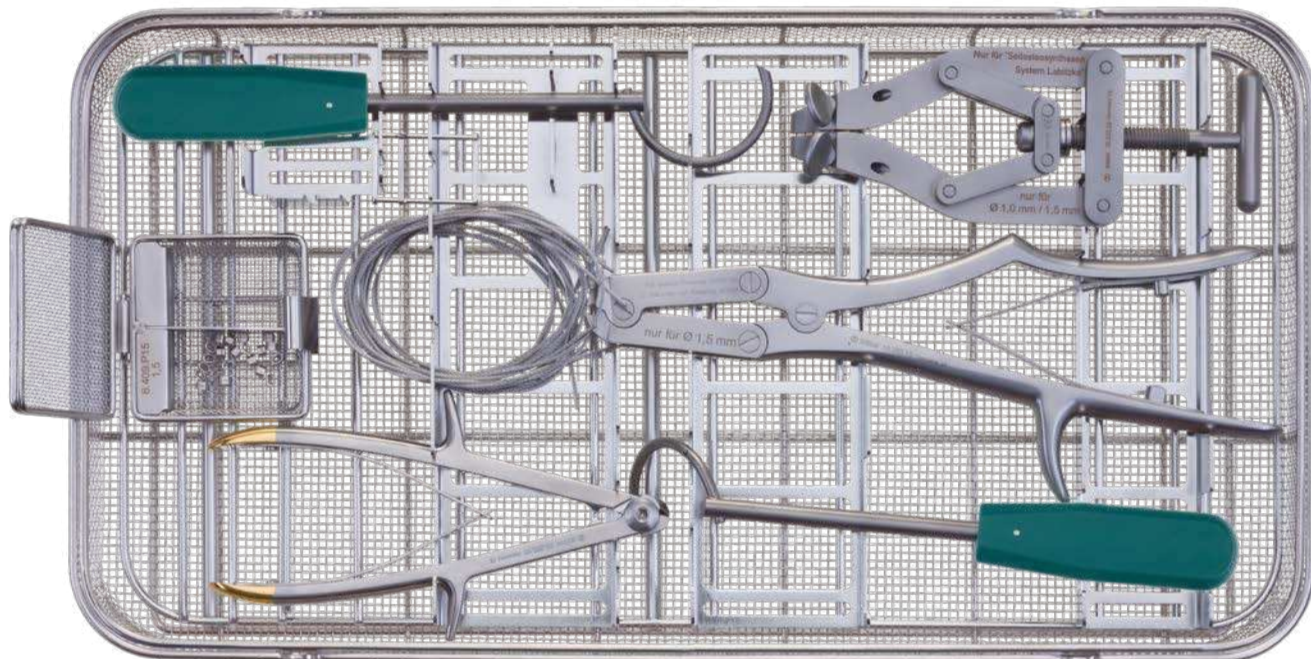

Set no. 19.518.00/1

Loop instrument for cables

For the Femur shaft, the Humerus shaft and the Trochanter region



Item no. 10.265.03/65

Item no. 10.265.03/25

Item no. 10.2656.03/50

Item no. 10.2656.03/25

Item no.	Item description	EAN
----------	------------------	-----

For the Trochanter region

- 10.265.03/65 loop instrument for cable, 120° angled; Ø65
- 10.2656.03/65 loop instrument for cable, 120° angled; Ø65
- 10.265.04/65 loop instrument for cable, straight; Ø65
- 10.2656.04/65 loop instrument for cable; straight; Ø65; L 277 mm

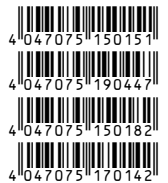

For the Femur shaft

- 10.265.03/50 loop instrument for cable, 120° angled; Ø50
- 10.2656.03/50 loop instrument for cable, 120° angled; Ø50
- 10.265.04/50 loop instrument for cable, straight; Ø50
- 10.2656.04/50 loop instrument for cable; straight; Ø50; L 261 mm

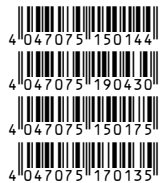

For the Humerus shaft

- 10.265.03/25 loop instrument for cable, 120° angled; Ø25
- 10.2656.03/25 loop instrument for cable, 120° angled; Ø25
- 10.265.04/25 loop instrument for cable, straight; Ø25
- 10.2656.04/25 loop instrument for cable; straight; Ø25; L 238 mm

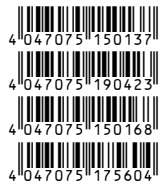

Königsee Implantate GmbH
 OT Aschau | Am Sand 4
 07426 Allendorf | Germany

Fon +49 36738 498-560
 Fax +49 36738 498-569

Mail export@koenigsee-implantate.de

For further information please visit:
www.koenigsee-implantate.com

AnSp | Edition 02 | 2020-09
 All pictured products are CE compliant.

CHILDREN

Königsee Implantate



Your Partner in Osteosynthesis

VaWiKo® EPI plate

variable angle stable; for screws Ø 4.0 mm; titanium



Item no. 5.6983.2160



without spikes



Item no. 5.6983.2122



with spikes

Item no.	Description	EAN
VaWiKo®EPI plate, TiOB® coated*		
5.6983.2122	VaWiKo® EPI-plate for hemiepiphyseodesis, hole spacing 12, 2 spikes	4 047075 172580
5.6983.2162	VaWiKo® EPI-plate for hemiepiphyseodesis, hole spacing 16, 2 spikes	4 047075 172603
5.6983.2120	VaWiKo® EPI-plate for hemiepiphyseodesis, hole spacing 12, without spikes	4 047075 172573
5.6983.2160	VaWiKo® EPI-plate for hemiepiphyseodesis, hole spacing 16, without spikes	4 047075 172597

*TiOB® is a trademark of Königsee Implantate GmbH registered in the EU countries, Switzerland and the USA. It is a surface coating that brings optimized properties.

Set VaWiKo® EPI plate

variable angle stable; for screws Ø 4.0 mm; titanium; Set no. 19.563.00



Item no. 5.6983.2122



Item no. 5.6983.2160



with spike



without spike



Set no. 19.563.00 Internal hexagon

Item no.	Item description	Quant.
Implants – plates		
VaWiKo®EPI plate, TiOB® coated*		
5.6983.2122	VaWiKo® EPI-plate for hemiepiphysode-sis,hole spacing 12,2 spikes	2
5.6983.2162	VaWiKo® EPI-plate for hemiepiphysode-sis,hole spacing 16,2 spikes	2
5.6983.2120	VaWiKo® EPI-plate for hemiepiphysode-sis,hole spacing 12,without spikes	2
5.6983.2160	VaWiKo® EPI-plate for hemiepiphysode-sis,hole spacing 16,without spikes	2

Instruments		
2.977.17	drill guide w.handle for variable angle stable screwing 4.0,length 68	1
2.950.150	gauge for cannulated screws Ø2.7 to Ø4.0,length 150	1
2.906.40	pilot drill bit f.quick coupling,Ø3x100,bore length 60,cannulated,inside Ø1.8	1
2.9436.40	hex screwdriver with handle for Ø2.7-4; cannulated; lØ1.7; wrench size 2.5; L 215mm	1
2.977.16	drill guide for angle stable screwing 4.0,length 68	2
2.904.25	drill bit for quick coupling,Ø3.0x155,spi-ral length 60,double spiral	1
2.977.14	drill guide for variable angle stable screwing 2.0,length 45	1
2.953.65	gauge w. clasp for screws Ø2.7,measu-ring range 60	1
2.954.01	screw forceps,self holding	1

Container		
19.562.00	perforated autoclavable container w.inset f. VaWiKo® EPI-Plate a.instruments	1

Item no.	Bezeichnung	Menge
Implants – screws		
Cortical screw Ø4, angle stable, self tapping, titanium		
3.148.22	Length 22 mm	4
3.148.26	Length 26 mm	4
3.148.30	Length 30 mm	4
3.148.36	Length 36 mm	4

Implants – screws		
Cannulated Ø4, full thread, self drilling, self tapping, titanium		
3.445.22	Length 22 mm	4
3.445.26	Length 26 mm	4
3.445.30	Length 30 mm	4
3.445.36	Length 36 mm	4

Wires		
2.982.16	guide wire,Ø1.6x150,thread 10,st.st.	5
6.031.10	Kirschner wire with tro-car point and round end,Ø1x150,st.st.	5

*TiOB® is a trademark of Königsee Implantate GmbH registered in the EU countries, Switzerland and the USA. It is a surface coating that brings optimized properties.



Königsee Implantate GmbH
OT Aschau | Am Sand 4
07426 Allendorf | Germany

Fon +49 36738 498-560
Fax +49 36738 498-569

Mail export@koenigsee-implantate.de

For further information please visit:
www.koenigsee-implantate.com

AnSp | Edition 02 | 2019-12
All pictured products are CE compliant.

Set VaWiKo[®] EPI plate

variable angle stable; for screws \varnothing 4.0 mm; titanium; Set no. 19.563.00



Children

Set angled plates instruments

for angled plates; Set No. 19.230.00



Item no. 10.230.01



Item no. 10.230.05



Item no. 10.230.03

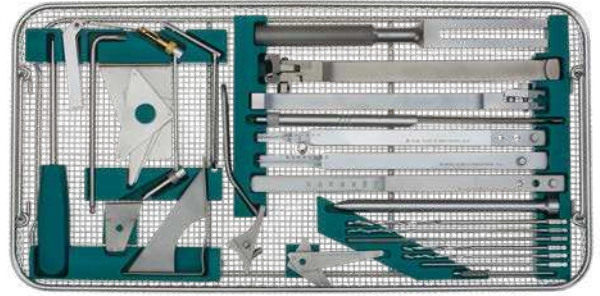

Item no. 19.230.00

Item no.	Item description	Quant.
Instruments		
10.230.01	triangular positioning plate 80°/70°/30°	1
10.230.02	triangular positioning plate 90°/50°/40°	1
10.230.03	triangular positioning plate 100°/60°/20°	1
10.230.04	triangular positioning plate for children 80°/70°/30°	1
10.230.05	triangular positioning plate for children 90°/50°/40°	1
10.230.06	triangular positioning plate for children 110°/60°/10°	1
10.230.07	positioning plate for variable osteotomy 110°/90°/90°/70°	1
10.230.08	positioning plate for variable osteotomy for children 110°/90°/90°/70°	1
10.230.09	condylar plate targeting device	1
10.230.10	impactor and extractor	1
10.230.11	impactor and extractor for angled plates for children	1
10.230.12	slit hammer	1
10.230.13	correcting bolt	1
10.230.14	plate fitting instrument for adults	1
10.230.15	plate fitting instrument for adolescents	1
10.230.16	plate fitting instrument for children	1
10.230.17	guide plate with adjustable angles	1
10.230.18	pin-countersink for three-jaw chuck	1
10.230.19	triple drill guide with fixed angle 130°	1
10.500.11	drill guide Ø3.2	1

Item no.	Item description	Quant.
Instruments		
10.500.20	drill guide for neutral and compression position, Ø3.2, inset 45	1
10.400.50	hex wrench, wrench width 5	1
2.904.08	drill bit for quick coupling, Ø3.2x145,- spiral length 60, double spiral	1
2.904.12	drill bit for quick coupling, Ø4.5x145,- spiral length 60, double spiral	1
2.925.45	tap for quick coupling for cortical screws, Ø4.5x130, thread 70	1
2.9406.35	hex screwdriver with handle for screws Ø4.5-Ø7.0, AF3.5, length 215	1
2.953.45	gauge with clasp for screws Ø4.5 and Ø6.5, measuring range 115	1
2.904.09	drill bit for quick coupling, Ø3.2x195,- spiral length 60, double spiral	1
2.904.13	drill bit for quick coupling, Ø4.5x195,- spiral length 85, double spiral	1
2.927.45	tap for quick coupling for cortical screws, Ø4.5x195, thread 70	1

Item no.	Item description	Quant.
Container		
19.231.00	perforated autoclavable container with inset for instruments for angled plates	1

Set angled plates instruments

for angled plates; Set No. 19.230.00

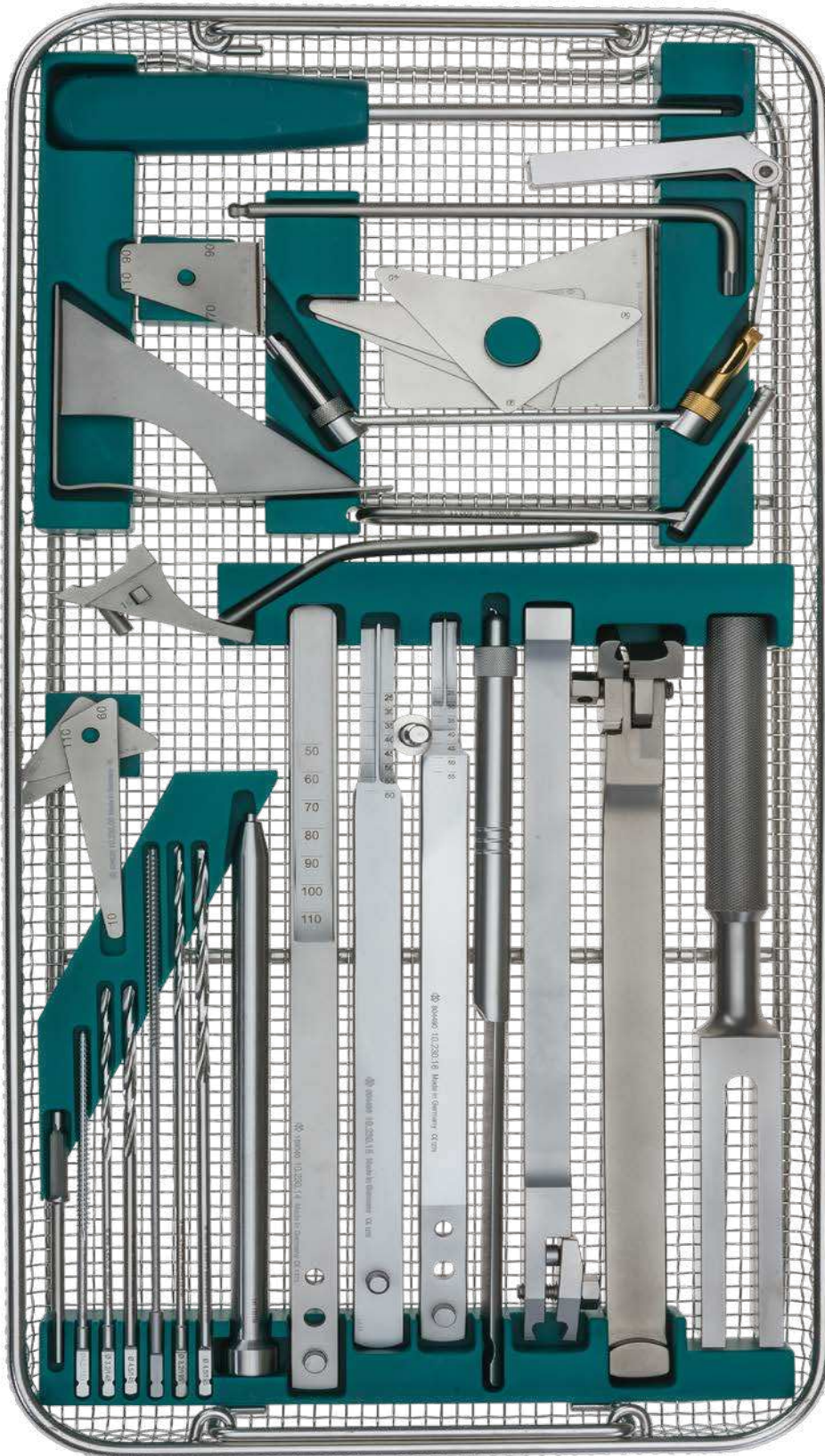

Item no. 19.230.00

Dynamic Epiphyseal Telescopic Screw (DET)

Stainless Steel



Item no. 6.285.80



Item no. 6.286.80

Item no.	Item description
6.285.40	DET-screw Ø 7.0 x 40 mm; thread 7.0 mm; inside Ø 2.2 mm; selftapping; backtapping; stainless steel
6.285.50	DET-screw Ø 7.0 x 50 mm; thread 7.0 mm; inside Ø 2.2 mm; selftapping; backtapping; stainless steel
6.285.60	DET-screw Ø 7.0 x 60 mm; thread 7.0 mm; inside Ø 2.2 mm; selftapping; backtapping; stainless steel
6.285.70	DET-screw Ø 7.0 x 70 mm; thread 7.0 mm; inside Ø 2.2 mm; selftapping; backtapping; stainless steel
6.285.80	DET-screw Ø 7.0 x 80 mm; thread 7.0 mm; inside Ø 2.2 mm; selftapping; backtapping; stainless steel
6.286.40	DET-screw sleeve Ø 7.5 x 40 mm; inside Ø 5.6 mm; stainless steel
6.286.50	DET-screw sleeve Ø 7.5 x 50 mm; inside Ø 5.6 mm; stainless steel
6.286.60	DET-screw sleeve Ø 7.5 x 60 mm; inside Ø 5.6 mm; stainless steel
6.286.70	DET-screw sleeve Ø 7.5 x 70 mm; inside Ø 5.6 mm; stainless steel
6.286.80	DET-screw sleeve Ø 7.5 x 80 mm; inside Ø 5.6 mm; stainless steel

Set Dynamic Epiphyseal Telescopic Screw (DET)

Stainless Steel; Set no. 19.501.00



Item no. 6.285.80



Item no. 6.286.80

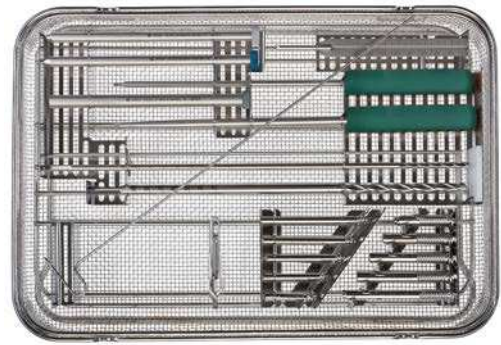

Item no. 19.501.00

Item no.	Item description	Quant.
Implants - screws		
DET-screw Ø 7.0 mm thread 7.0 mm; inside Ø 2.2 mm selftapping; backtapping; stainless steel		
6.285.40	length 40 mm	3
6.285.50	length 50 mm	3
6.285.60	length 60 mm	3
6.285.70	length 70 mm	3
6.285.80	length 80 mm	3

DET-screw sleeve Ø 7.5 mm inside Ø 5.6 mm; stainless steel		
6.286.40	length 40 mm	3
6.286.50	length 50 mm	3
6.286.60	length 60 mm	3
6.286.70	length 70 mm	3
6.286.80	length 80 mm	3

Wire		
2.988.20/310	guide wire; Ø 2.0 mm x 310 mm; thread 15 mm; stainless steel	5

Container		
19.500.00	perforated autoclavable container with inset for instruments and DET-screws	1

Item no.	Item description	Quant.
Instruments		
2.9436.35/275	hex screwdriver with handle for Ø 4.5 mm - Ø 7.0 mm; cannulated; inside Ø 2.2 mm; wrench size 3.5 mm; length 275 mm	1
2.9476.02	screwdriver for extraction for DET-screw; length 275 mm	1
2.908.76	drill bit with triangular shank; Ø 7.6 mm x 285 mm; spiral length 100 mm; cannulated; inside Ø 2.2 mm; triple spiral	1
10.261.19	drill bit with triangular shank; Ø 4.8 mm x 320 mm; triple spiral; spiral length 55 mm; cannulated; inside Ø 2.2 mm	1
10.261.01	drill guide; Ø 8.0 x 150 mm; green	1
10.261.03	drill guide; Ø 4.8 x 160 mm; blue	1
10.261.02	drill guide; Ø 2.1 x 160 mm; silver	1
2.950.02	gauge for DET-screw; length 145 mm; measuring range 120 mm	1
2.928.01	instrument for holding of wires for DET-screw; Ø 2.0 mm; length 347 mm	1
2.954.01	screw forceps; self holding	1

Set Dynamic Epiphyseal Telescopic Screw (DET)

Stainless Steel; Set no. 19.501.00

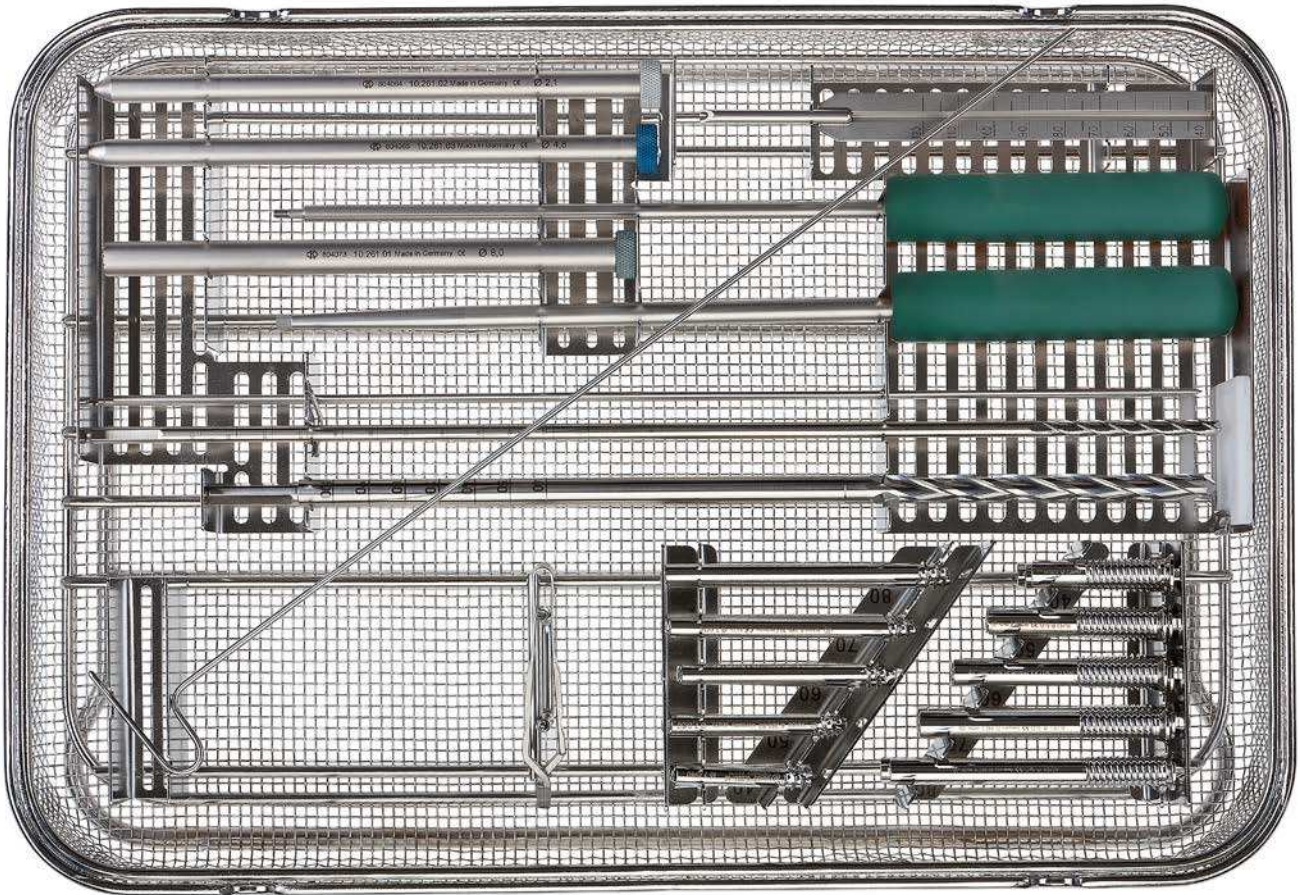

Item no. 19.501.00

Gliding Nail

Titanium



Item no. 7.282.45

Item no.	Item description
----------	------------------

Gliding nail; length 300 mm

7.282.12	gliding nail; Ø 1.2 mm; length 300 mm; titanium
7.282.15	gliding nail; Ø 1.5 mm; length 300 mm; titanium
7.282.16	gliding nail; Ø 1.6 mm; length 300 mm; titanium
7.282.18	gliding nail; Ø 1.8 mm; length 300 mm; titanium
7.282.20	gliding nail; Ø 2.0 mm; length 300 mm; titanium
7.282.25	gliding nail; Ø 2.5 mm; length 300 mm; titanium
7.282.30	gliding nail; Ø 3.0 mm; length 300 mm; titanium
7.282.32	gliding nail; Ø 3.2 mm; length 300 mm; titanium
7.282.35	gliding nail; Ø 3.5 mm; length 300 mm; titanium
7.282.40	gliding nail; Ø 4.0 mm; length 300 mm; titanium
7.282.45	gliding nail; Ø 4.5 mm; length 300 mm; titanium
7.282.50	gliding nail; Ø 5.0 mm; length 300 mm; titanium

Gliding nail; length 450 mm

7.281.12	gliding nail; Ø 1.2 mm; length 450 mm; titanium
7.281.15	gliding nail; Ø 1.5 mm; length 450 mm; titanium
7.281.16	gliding nail; Ø 1.6 mm; length 450 mm; titanium
7.281.18	gliding nail; Ø 1.8 mm; length 450 mm; titanium
7.281.20	gliding nail; Ø 2.0 mm; length 450 mm; titanium
7.281.25	gliding nail; Ø 2.5 mm; length 450 mm; titanium
7.281.30	gliding nail; Ø 3.0 mm; length 450 mm; titanium
7.281.32	gliding nail; Ø 3.2 mm; length 450 mm; titanium
7.281.35	gliding nail; Ø 3.5 mm; length 450 mm; titanium
7.281.40	gliding nail; Ø 4.0 mm; length 450 mm; titanium
7.281.45	gliding nail; Ø 4.5 mm; length 450 mm; titanium
7.281.50	gliding nail; Ø 5.0 mm; length 450 mm; titanium

Gliding Nail

Titanium

Item no.	Item description
Gliding nail; alternative lengths	
7.282.15/150	gliding nail; Ø 1.5 mm; length 150 mm; titanium
7.282.20/150	gliding nail; Ø 2.0 mm; length 150 mm; titanium
7.281.20/250	gliding nail; Ø 2.0 mm; length 250 mm; titanium
7.281.20/400	gliding nail; Ø 2.0 mm; length 400 mm; titanium
7.281.25/400	gliding nail; Ø 2.5 mm; length 400 mm; titanium
7.281.30/400	gliding nail; Ø 3.0 mm; length 400 mm; titanium
7.281.32/400	gliding nail; Ø 3.2 mm; length 400 mm; titanium
7.281.35/400	gliding nail; Ø 3.5 mm; length 400 mm; titanium
7.281.40/250	gliding nail; Ø 4.0 mm; length 250 mm; titanium

Set Gliding Nails

length 300 mm; titanium; Set no. 19.290.00



Item no. 7.282.45

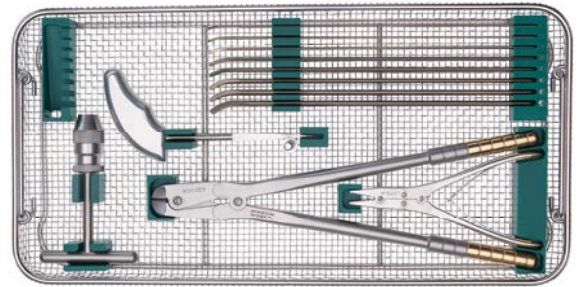

Item no. 19.292.00

Item no.	Item description	Quant.
Implants – nails		
Gliding nail; length 300 mm; titanium		
		
7.282.15	Ø 1.5 mm; titanium	2
7.282.20	Ø 2.0 mm; titanium	2
7.282.25	Ø 2.5 mm; titanium	2
7.282.30	Ø 3.0 mm; titanium	2
7.282.32	Ø 3.2 mm; titanium	2
7.282.40	Ø 4.0 mm; titanium	2
7.282.45	Ø 4.5 mm; titanium	2
7.282.50	Ø 5.0 mm; titanium	2

Item no.	Item description	Quant.
Instruments		
6.903.02	impactor with quick-action chuck; cannulated; inside Ø 5.2 mm	1
6.906.03	power cutter for wires to maximum Ø 3.0 mm (stainless steel) and Ø 4.0 mm (titanium)	1
10.421.01	extraction forceps for wires; flat	1
10.509.00	awl; Ø 8.0 mm	1

Container		
19.291.00	perforated autoclavable container with inset for instruments and gliding nails	1

Additionally you can order item no. 6.906.06 – power cutter for wires to maximum Ø 6.0 mm.

Set Gliding Nails

length 300 mm; titanium; Set no. 19.290.00

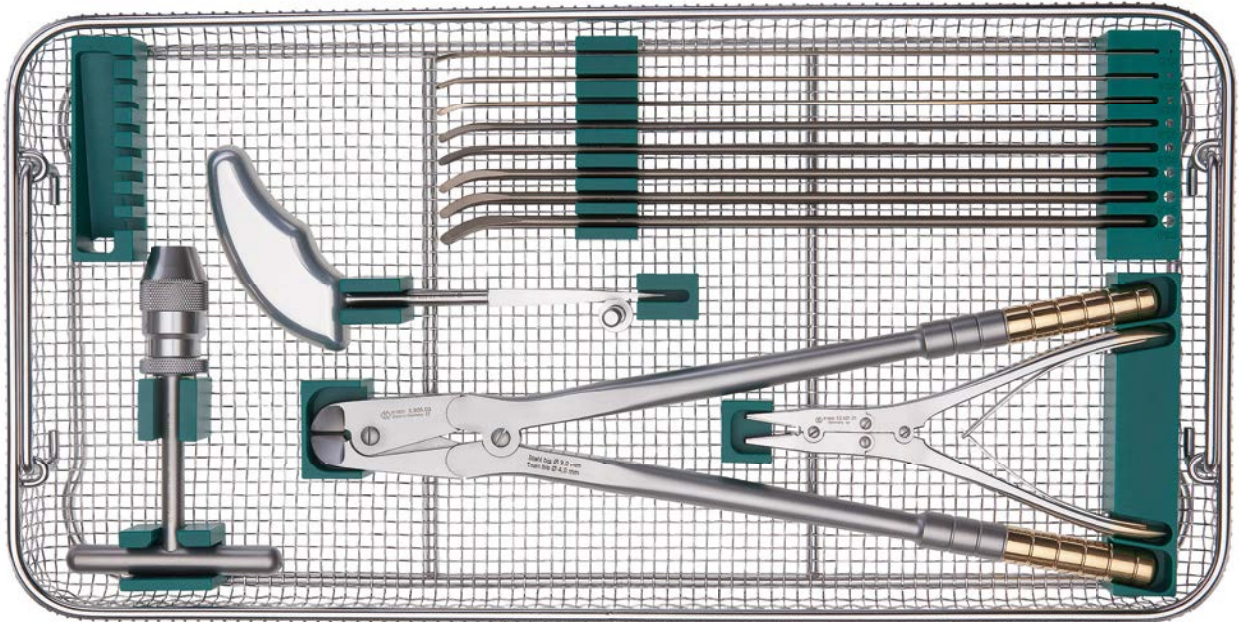

Item no. 19.290.00

Set Gliding Nails

length 450 mm; titanium; Set no. 19.290.10



Item no. 7.281.45

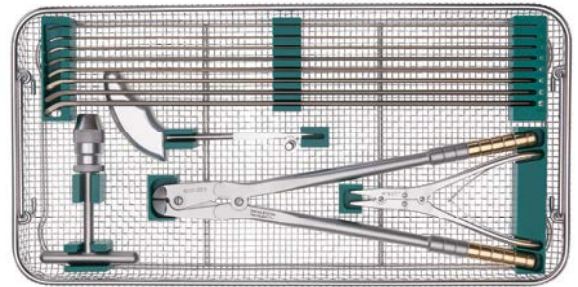

Item no. 19.292.10

Item no.	Item description	Quant.
Implants – nails		
Gliding nail; length 450 mm; titanium		
		
7.281.15	Ø 1.5 mm; titanium	2
7.281.20	Ø 2.0 mm; titanium	2
7.281.25	Ø 2.5 mm; titanium	2
7.281.32	Ø 3.0 mm; titanium	2
7.281.35	Ø 3.2 mm; titanium	2
7.281.40	Ø 4.0 mm; titanium	2
7.281.45	Ø 4.5 mm; titanium	2
7.281.50	Ø 5.0 mm; titanium	2

Item no.	Item description	Quant.
Instruments		
6.903.02	impactor with quick-action chuck; cannulated; inside Ø 5.2 mm	1
6.906.03	power cutter for wires to maximum Ø 3.0 mm (stainless steel) and Ø 4.0 mm (titanium)	1
10.421.01	extraction forceps for wires; flat	1
10.509.00	awl; Ø 8.0 mm	1

Container		
19.291.00	perforated autoclavable container with inset for instruments and gliding nails	1

Additionally you can order item no. 6.906.06 – power cutter for wires to maximum Ø 6.0 mm.

Set Gliding Nails

length 450 mm; titanium; Set no. 19.290.10

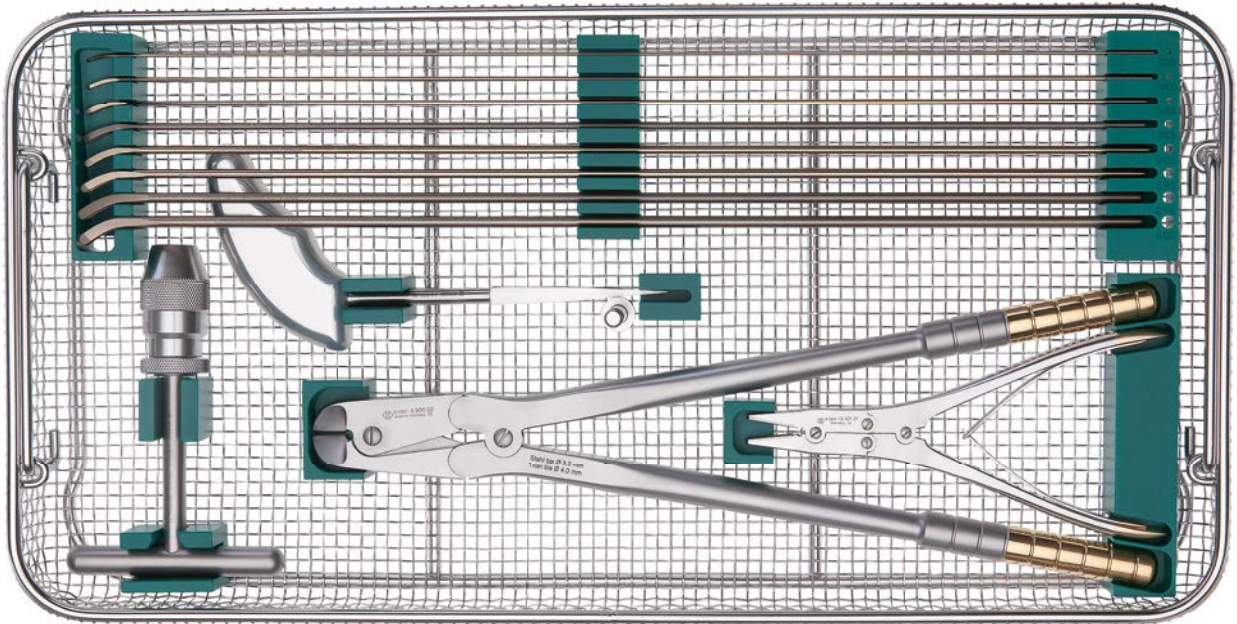

Item no. 19.290.10

Gliding Nail

Stainless Steel



Item no. 6.282.45

Item no.	Item description
----------	------------------

Gliding nail; length 300 mm

6.282.15	gliding nail; Ø 1.5 mm; length 300 mm; stainless steel
6.282.20	gliding nail; Ø 2.0 mm; length 300 mm; stainless steel
6.282.25	gliding nail; Ø 2.5 mm; length 300 mm; stainless steel
6.282.30	gliding nail; Ø 3.0 mm; length 300 mm; stainless steel
6.282.32	gliding nail; Ø 3.2 mm; length 300 mm; stainless steel
6.282.35	gliding nail; Ø 3.5 mm; length 300 mm; stainless steel
6.282.40	gliding nail; Ø 4.0 mm; length 300 mm; stainless steel
6.282.45	gliding nail; Ø 4.5 mm; length 300 mm; stainless steel
6.282.50	gliding nail; Ø 5.0 mm; length 300 mm; stainless steel

Gliding nail; length 450 mm

6.281.15	gliding nail; Ø 1.5 mm; length 450 mm; stainless steel
6.281.20	gliding nail; Ø 2.0 mm; length 450 mm; stainless steel
6.281.25	gliding nail; Ø 2.5 mm; length 450 mm; stainless steel
6.281.30	gliding nail; Ø 3.0 mm; length 450 mm; stainless steel
6.281.32	gliding nail; Ø 3.2 mm; length 450 mm; stainless steel
6.281.35	gliding nail; Ø 3.5 mm; length 450 mm; stainless steel
6.281.40	gliding nail; Ø 4.0 mm; length 450 mm; stainless steel
6.281.45	gliding nail; Ø 4.5 mm; length 450 mm; stainless steel
6.281.50	gliding nail; Ø 5.0 mm; length 450 mm; stainless steel

Gliding nail; alternative lengths

6.282.32/320	gliding nail; Ø 3.2 mm; length 320 mm; stainless steel
6.281.35/350	gliding nail; Ø 3.5 mm; length 350 mm; stainless steel

Set Gliding Nails

length 300 mm; stainless steel; Set no. 19.292.00



Item no. 6.282.45

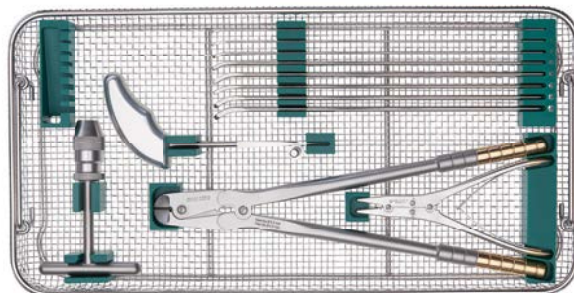

Item no. 19.292.00

Item no.	Item description	Quant.
Implants – nails		
Gliding nail; length 300 mm; stainless steel		
		
6.282.15	Ø 1.5 mm; stainless steel	2
6.282.20	Ø 2.0 mm; stainless steel	2
6.282.25	Ø 2.5 mm; stainless steel	2
6.282.32	Ø 3.0 mm; stainless steel	2
6.282.35	Ø 3.2 mm; stainless steel	2
6.282.40	Ø 4.0 mm; stainless steel	2
6.282.45	Ø 4.5 mm; stainless steel	2
6.282.50	Ø 5.0 mm; stainless steel	2

Item no.	Item description	Quant.
Instruments		
6.903.02	impactor with quick-action chuck; cannulated; inside Ø 5.2 mm	1
6.906.03	power cutter for wires to maximum Ø 3.0 mm (stainless steel) and Ø 4.0 mm (titanium)	1
10.421.01	extraction forceps for wires; flat	1
10.509.00	awl; Ø 8.0 mm	1
Container		
19.291.00	perforated autoclavable container with inset for instruments and gliding nails	1

Additionally you can order item no. 6.906.06 – power cutter for wires to maximum Ø 6.0 mm.

Set Gliding Nails

length 300 mm; stainless steel; Set no. 19.292.00

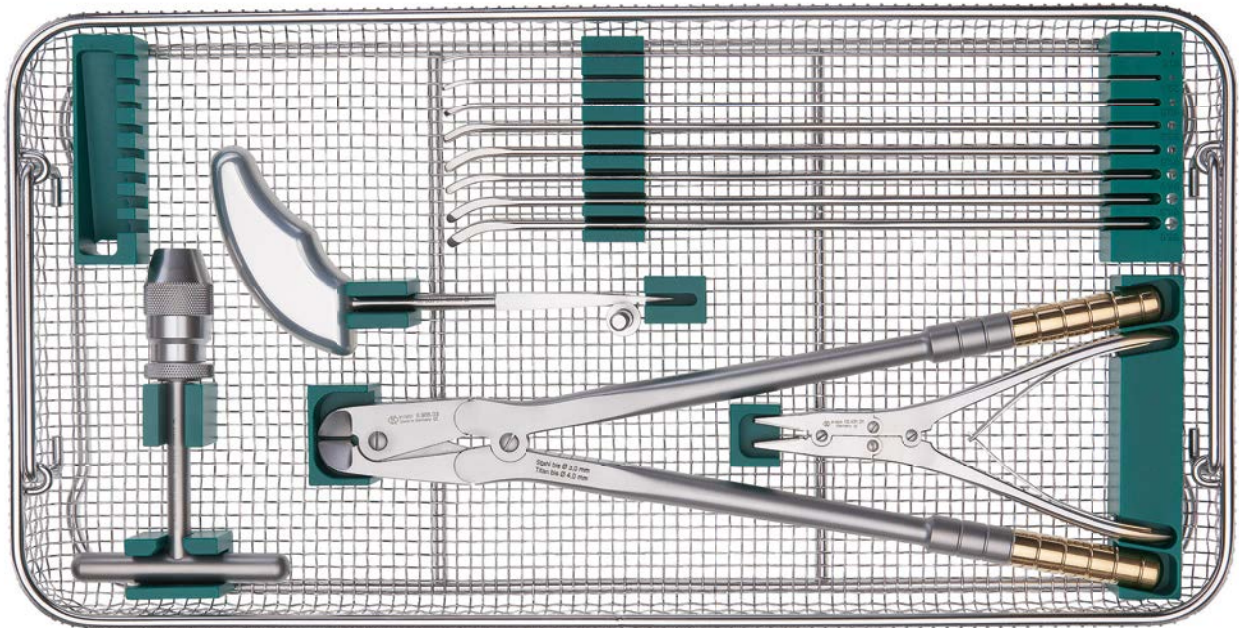

Item no. 19.292.00

Set Gliding Nails

length 450 mm; stainless steel; Set no. 19.292.10



Item no. 6.281.45

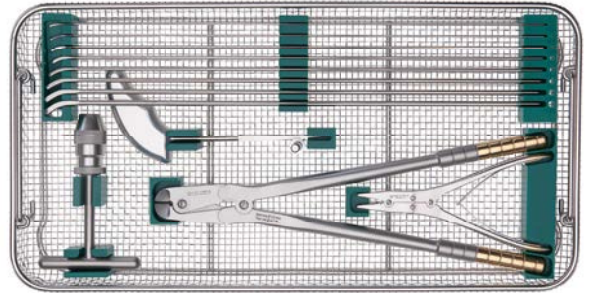

Item no. 19.292.10

Item no.	Item description	Quant.
Implants – nails		
Gliding nail; length 450 mm; stainless steel		
		
6.281.15	Ø 1.5 mm; stainless steel	2
6.281.20	Ø 2.0 mm; stainless steel	2
6.281.25	Ø 2.5 mm; stainless steel	2
6.281.32	Ø 3.0 mm; stainless steel	2
6.281.35	Ø 3.2 mm; stainless steel	2
6.281.40	Ø 4.0 mm; stainless steel	2
6.281.45	Ø 4.5 mm; stainless steel	2
6.281.50	Ø 5.0 mm; stainless steel	2

Item no.	Item description	Quant.
Instruments		
6.903.02	impactor with quick-action chuck; cannulated; inside Ø 5.2 mm	1
6.906.03	power cutter for wires to maximum Ø 3.0 mm (stainless steel) and Ø 4.0 mm (titanium)	1
10.421.01	extraction forceps for wires; flat	1
10.509.00	awl; Ø 8.0 mm	1

Container		
19.291.00	perforated autoclavable container with inset for instruments and gliding nails	1

Additionally you can order item no. 6.906.06 – power cutter for wires to maximum Ø 6.0 mm.

Set Gliding Nails

length 450 mm; stainless steel; Set no. 19.292.10

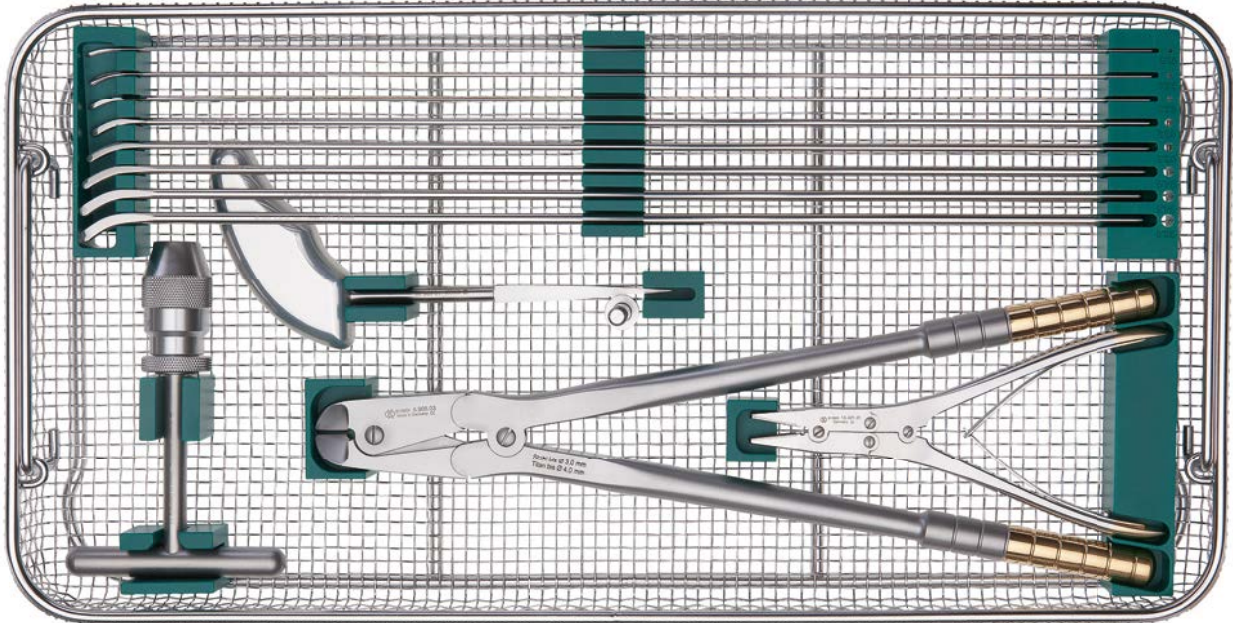

Item no. 19.292.10

Telescope Nail Bailey-Dubow

for Osteogenesis Imperfecta; Ø 3.2 mm – Ø 6.4 mm; titanium



Item no. 7.288.00

Item no.	Item description	EAN
----------	------------------	-----

Telescope nail Bailey-Dubow for glass bone; Ø 3.2 mm; size 1

7.288.00	telescope nail "Bailey" for glass bone; Ø 3.2 mm; length 250 mm; size 1; titanium	 4047075036547
7.288.00/70	telescope nail "Bailey" for glass bone; Ø 3.2 mm; length 70 mm; size 1; titanium	 4047075036387
7.288.00/80	telescope nail "Bailey" for glass bone; Ø 3.2 mm; length 80 mm; size 1; titanium	 4047075036301
7.288.00/100	telescope nail "Bailey" for glass bone; Ø 3.2 mm; length 100 mm; size 1; titanium	 4047075036554
7.288.00/120	telescope nail "Bailey" for glass bone; Ø 3.2 mm; length 120 mm; size 1; titanium	 4047075036561
7.288.00/135	telescope nail "Bailey" for glass bone; Ø 3.2 mm; length 135 mm; size 1; titanium	 4047075115822
7.288.00/140	telescope nail "Bailey" for glass bone; Ø 3.2 mm; length 140 mm; size 1; titanium	 4047075124794
7.288.00/150	telescope nail "Bailey" for glass bone; Ø 3.2 mm; length 150 mm; size 1; titanium	 4047075036578
7.288.00/160	telescope nail "Bailey" for glass bone; Ø 3.2 mm; length 160 mm; size 1; titanium	 4047075036363
7.288.00/170	telescope nail "Bailey" for glass bone; Ø 3.2 mm; length 170 mm; size 1; titanium	 4047075116737
7.288.00/200	telescope nail "Bailey" for glass bone; Ø 3.2 mm; length 200 mm; size 1; titanium	 4047075155088
7.288.00/210	telescope nail "Bailey" for glass bone; Ø 3.2 mm; length 210 mm; size 1; titanium	 4047075141944
7.288.00/220	telescope nail "Bailey" for glass bone; Ø 3.2 mm; length 220 mm; size 1; titanium	 4047075057474
7.288.00/230	telescope nail "Bailey" for glass bone; Ø 3.2 mm; length 230 mm; size 1; titanium	 4047075036370

Telescope nail Bailey-Dubow for glass bone; Ø 4.0 mm; size 2







7.289.00	telescope nail "Bailey" for glass bone; Ø 4.0 mm; length 250 mm; size 2; titanium	 4047075036639
7.289.00/120	telescope nail "Bailey" for glass bone; Ø 4.0 mm; length 120 mm; size 2; titanium	 4047075129058
7.289.00/130	telescope nail "Bailey" for glass bone; Ø 4.0 mm; length 130 mm; size 2; titanium	 4047075036646
7.289.00/135	telescope nail "Bailey" for glass bone; Ø 4.0 mm; length 135 mm; size 2; titanium	 4047075115839
7.289.00/160	telescope nail "Bailey" for glass bone; Ø 4.0 mm; length 160 mm; size 2; titanium	 4047075137572
7.289.00/170	telescope nail "Bailey" for glass bone; Ø 4.0 mm; length 170 mm; size 2; titanium	 4047075163601
7.289.00/200	telescope nail "Bailey" for glass bone; Ø 4.0 mm; length 200 mm; size 2; titanium	 4047075155903
7.289.00/210	telescope nail "Bailey" for glass bone; Ø 4.0 mm; length 210 mm; size 2; titanium	 4047075036653
7.289.00/220	telescope nail "Bailey" for glass bone; Ø 4.0 mm; length 220 mm; size 2; titanium	 4047075113804
7.289.00/230	telescope nail "Bailey" for glass bone; Ø 4.0 mm; length 230 mm; size 2; titanium	 4047075036660

Telescope Nail Bailey-Dubow









for Osteogenesis Imperfecta; Ø 3.2 mm – Ø 6.4 mm; titanium

Item no.	Item description	EAN
----------	------------------	-----



Telescope nail Bailey-Dubow for glass bone; Ø 4.8 mm; size 3

7.290.00	telescope nail "Bailey" for glass bone; Ø 4.8 mm; length 300 mm; size 3; titanium	 4047075036479
7.290.00/70	telescope nail "Bailey" for glass bone; Ø 4.8 mm; length 70 mm; size 3; titanium	 4047075116331
7.290.00/80	telescope nail "Bailey" for glass bone; Ø 4.8 mm; length 80 mm; size 3; titanium	 4047075116348
7.290.00/85	telescope nail "Bailey" for glass bone; Ø 4.8 mm; length 85 mm; size 3; titanium	 4047075116355
7.290.00/90	telescope nail "Bailey" for glass bone; Ø 4.8 mm; length 90 mm; size 3; titanium	 4047075116362
7.290.00/100	telescope nail "Bailey" for glass bone; Ø 4.8 mm; length 100 mm; size 3; titanium	 4047075128495
7.290.00/120	telescope nail "Bailey" for glass bone; Ø 4.8 mm; length 120 mm; size 3; titanium	 4047075129065
7.290.00/130	telescope nail "Bailey" for glass bone; Ø 4.8 mm; length 130 mm; size 3; titanium	 4047075163649
7.290.00/140	telescope nail "Bailey" for glass bone; Ø 4.8 mm; length 140 mm; size 3; titanium	 4047075124800
7.290.00/170	telescope nail "Bailey" for glass bone; Ø 4.8 mm; length 170 mm; size 3; titanium	 4047075116805
7.290.00/180	telescope nail "Bailey" for glass bone; Ø 4.8 mm; length 180 mm; size 3; titanium	 4047075110810
7.290.00/200	telescope nail "Bailey" for glass bone; Ø 4.8 mm; length 200 mm; size 3; titanium	 4047075110827
7.290.00/230	telescope nail "Bailey" for glass bone; Ø 4.8 mm; length 230 mm; size 3; titanium	 4047075036486
7.290.00/250	telescope nail "Bailey" for glass bone; Ø 4.8 mm; length 250 mm; size 3; titanium	 4047075036493

Telescope nail Bailey-Dubow for glass bone; Ø 5.5 mm; size 4









7.291.00	telescope nail "Bailey" for glass bone; Ø 5.5 mm; length 300 mm; size 4; titanium	 4047075036769
7.291.00/130	telescope nail "Bailey" for glass bone; Ø 5.5 mm; length 130 mm; size 4; titanium	 4047075114313
7.291.00/140	telescope nail "Bailey" for glass bone; Ø 5.5 mm; length 140 mm; size 4; titanium	 4047075163656
7.291.00/170	telescope nail "Bailey" for glass bone; Ø 5.5 mm; length 170 mm; size 4; titanium	 4047075116812
7.291.00/180	telescope nail "Bailey" for glass bone; Ø 5.5 mm; length 180 mm; size 4; titanium	 4047075036776
7.291.00/230	telescope nail "Bailey" for glass bone; Ø 5.5 mm; length 230 mm; size 4; titanium	 4047075036783
7.291.00/250	telescope nail "Bailey" for glass bone; Ø 5.5 mm; length 250 mm; size 4; titanium	 4047075036790
7.291.00/280	telescope nail "Bailey" for glass bone; Ø 5.5 mm; length 280 mm; size 4; titanium	 4047075038510

Telescope nail Bailey-Dubow for glass bone; Ø 6.4 mm; size 5

7.292.00	telescope nail "Bailey" for glass bone; Ø 6.4 mm; length 350 mm; size 5; titanium	 4047075036608
7.292.00/250	telescope nail "Bailey" for glass bone; Ø 6.4 mm; length 250 mm; size 5; titanium	 4047075037940
7.292.00/300	telescope nail "Bailey" for glass bone; Ø 6.4 mm; length 300 mm; size 5; titanium	 4047075114658

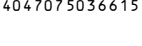
Telescope Nail Bailey-Dubow

for Osteogenesis Imperfecta; Ø 3.2 mm – Ø 6.4 mm; titanium

Item no.	Item description	EAN
Accessories		
7.288.01	drilling point for telescope nail Size 1; titanium	 4047075036394
7.289.01	drilling point for telescope nail size 2; titanium	 4047075036677
7.290.01	drilling point for telescope nail size 3; titanium	 4047075036509
7.291.01	drilling point for telescope nail size 4; titanium	 4047075036806
7.292.01	drilling point for telescope nail size 5; titanium	 4047075036615
7.288.02	cancellous screw for telescope nail size 1; Ø 4.0 mm; 25 mm; M 2.5; titanium	 4047075036622
7.289.02	cancellous screw for telescope nail size 2; Ø 4.0 mm; 25 mm; M 3; titanium	 4047075036691
7.290.02	cancellous screw for telescope nail size 3; Ø 4.0 mm; 25mm; M 3.5; titanium	 4047075036516
7.291.02	cancellous screw for telescope nail size 4; Ø 4.0 mm; 25 mm; M 4; titanium	 4047075036585

WiKo® Proximal Femur-osteotomy plate 3.5/6.0

Angle-stable cannulated screws Ø 6.0 mm; stainless steel; DVO Pediatric hip system*



Item no. 4.6402.0403

Item no. 4.6402.0404

Item no. 4.6402.0603

Item no. 4.6402.0803

Item no.	Item description	EAN
WiKo® proximal femur-osteotomy plate 3.5/6.0		
4.6402.0403	WiKo® proximal femur-osteotomy plate 3.5/6.0; 3 holes; 70 mm; arc depth 4	4 047075 177332
4.6402.0404	WiKo® proximal femur-osteotomy plate 3.5/6.0; 4 holes; 81 mm; arc depth 4	4 047075 177349
4.6402.0603	WiKo® proximal femur-osteotomy plate 3.5/6.0; 3 holes; 73 mm; arc depth 6	4 047075 177356
4.6402.0604	WiKo® proximal femur-osteotomy plate 3.5/6.0; 4 holes; 84 mm; arc depth 6	4 047075 177363
4.6402.0803	WiKo® proximal femur-osteotomy plate 3.5/6.0; 3 holes; 77 mm; arc depth 8	4 047075 177370
4.6402.0804	WiKo® proximal femur-osteotomy plate 3.5/6.0, 4 holes; 88 mm; arc depth 8	4 047075 177387

in use with three types of screws:

2.540.XX	Cannulated screw; Ø 6.0 mm; inside-Ø 2.2 mm; fully threaded; self drilling; self tapping; angle-stable
2.133.XX	Cortical screw with conical head thread; Ø 3.5 mm; fully threaded; self tapping; stainless steel
2.132.XX	Cortical screw; Ø 3.5 mm; fully threaded; self tapping; stainless steel

* Information:

For the complete implant system are the WiKo® proximal femur osteotomy plate, the angle-stable cannulated screw Ø 6.0 mm and the angle-stable and non angle-stable cortical screw Ø 3.5 mm in respective lengths required.

DVO - Derotation-Varisation-Osteotomy

The system name WiKo® derives from the description "angle-stable combination". This is a plating technology that provides a stable lock at a given angle. WiKo® is a registered trademark of Königsee Implantate GmbH in Germany.



Königsee Implantate GmbH
OT Aschau | Am Sand 4
07426 Allendorf | Germany

Fon +49 36738 498-560
Fax +49 36738 498-569

Mail export@koenigsee-implantate.de

For further information please visit:
www.koenigsee-implantate.com

HeBo | Edition 02 | 2020-05
All pictured products are CE compliant.

WiKo® Proximal Femur-osteotomy plate 3.5/6.0

DVO Pediatric Hip System; children plate; stainless steel; Set no. 19.561.10



Item no. 4.6402.0404



Item no. 4.6402.0803



Item no. 4.6402.0603





Item no. 4.6402.0403



Set no. 19.561.10  Internal hexagon

Item no.	Item description	Quant.
Implants – plates		
	WiKo® proximal femur-osteotomy plate; stainless steel	
4.6402.0403	3.5/6.0; 3 holes; 70 mm; arc depth 4	1
4.6402.0404	3.5/6.0; 4 holes; 81 mm; arc depth 4	1
4.6402.0603	3.5/6.0; 3 holes; 73 mm; arc depth 6	1
4.6402.0604	3.5/6.0; 4 holes; 84 mm; arc depth 6	1
4.6402.0803	3.5/6.0; 3 holes; 77 mm; arc depth 8	1

Implants – screws		
	Cortical screw Ø 3.5 mm; fully threaded; self tapping; angle-stable; stainless steel	
2.133.14	length 14 mm	3
2.133.16	length 16 mm	3
2.133.18	length 18 mm	3
2.133.20	length 20 mm	3
2.133.22	length 22 mm	3
2.133.24	length 24 mm	3
2.133.26	length 26 mm	3
2.133.28	length 28 mm	3
2.133.30	length 30 mm	3
2.133.32	length 32 mm	3
2.133.34	length 34 mm	3
2.133.36	length 36 mm	3
2.133.38	length 38 mm	3

Implants – screws		
	Cannulated screw Ø 6.0 mm; fully thread.; self drilling; self tapping; inside-Ø 2.2 mm; angle-stable; stainl. steel	
2.540.28	length 28 mm	2
2.540.30	length 30 mm	2
2.540.34	length 34 mm	2
2.540.38	length 38 mm	2
2.540.42	length 42 mm	2
2.540.46	length 46 mm	2
2.540.50	length 50 mm	2
2.540.52	length 52 mm	2
2.540.56	length 56 mm	2
2.540.60	length 60 mm	2
2.540.65	length 65 mm	2
	Cortical screw Ø 3.5 mm; fully threaded; self tapping; stainless steel	
2.132.14	length 14 mm	2
2.132.16	length 16 mm	2
2.132.18	length 18 mm	2
2.132.20	length 20 mm	2
2.132.22	length 22 mm	2
2.132.24	length 24 mm	2
2.132.26	length 26 mm	2
2.132.28	length 28 mm	2
2.132.30	length 30 mm	2
2.132.32	length 32 mm	2
2.132.34	length 34 mm	2
2.132.36	length 36 mm	2
2.132.38	length 38 mm	2

WiKo® Proximal Femur-osteotomy plate 3.5/6.0

DVO Pediatric Hip System; children plate; stainless steel; Set no. 19.561.10



upper level, femur-osteotomy plates and triangular positioning plate



upper level, Instruments Large fragment



lower level, Instruments Small fragment



lower level, targeting device and guide sleeve

Item no.	Item description	Quant.
Instruments		
10.230.01	triangular positioning plate 80°/70°/30°	1
10.230.02	triangular positioning plate 90°/50°/40°	1
10.230.03	triangular positioning plate 100°/60°/20°	1
10.230.20	targeting device; variable	1
10.230.21	holding instrument for targeting device	1
10.230.24	guide sleeve for screwdriver; Ø 15 mm x 80 mm; inside Ø 7.0 mm	1
10.230.22	cleaning adapter for targeting device 10.230.20; Ø 6.2 mm with hose connection	1
2.954.01	screw forceps; self holding	1
Large fragment		
2.942.02	hex screwdriver with T-handle for screws Ø 4.5 - 7.0 mm; cannulated; inside Ø 2.2 mm	1
2.908.40	drill bit with triangular shank; Ø 4.0 x 230 mm; spiral length 40 mm; cannulated; inside Ø 2.1 mm; triple spiral	1
2.952.230	gauge for cannulated screws Ø 6.5 mm and Ø 7.0 mm; length 230 mm	1
Small fragment		
2.9405.25	hex screwdriver for screws Ø 2.7 - 4.0 mm; wrench width 2.5; conical; length 215 mm	1
2.904.22	drill bit for quick coupling; Ø 2.5 x 155 mm; spiral length 60 mm; double spiral	1
2.977.04	drill guide for angle stable screwing; length 68 mm	2
10.500.04	drill guide for neutral and compression position; Ø 2.5 mm	1
2.953.70	gauge with clasp for screws with conical head thread Ø 3.5 mm and Ø 4.0 mm; measuring range 70 mm	1

Item no.	Item description	Quant.
Wire		
6.031.20	Kirschner wire with trocar point and round end; Ø 2.0 mm x 150 mm; stainless steel	5
6.041.20/230	Kirschner wire with trocar point and round end; Ø 2.0 mm x 230 mm; stainless steel	5
Container		
19.560.00	perforated autoclavable container with inset for instruments for WiKo®-DVO; Pediatric Hip System	1

Information:

The system name WiKo® derives from the description „angle-stable combination“. This is a plating technology that provides a stable lock at a given angle.

WiKo® is a registered trademark of Königsee Implantate GmbH in Germany.

DVO - Derotation-Varisation-Osteotomy

WiKo® Proximal Femur-osteotomy plate 3.5/6.0

DVO Pediatric Hip System; children plate; stainless steel; Set no. 19.561.10

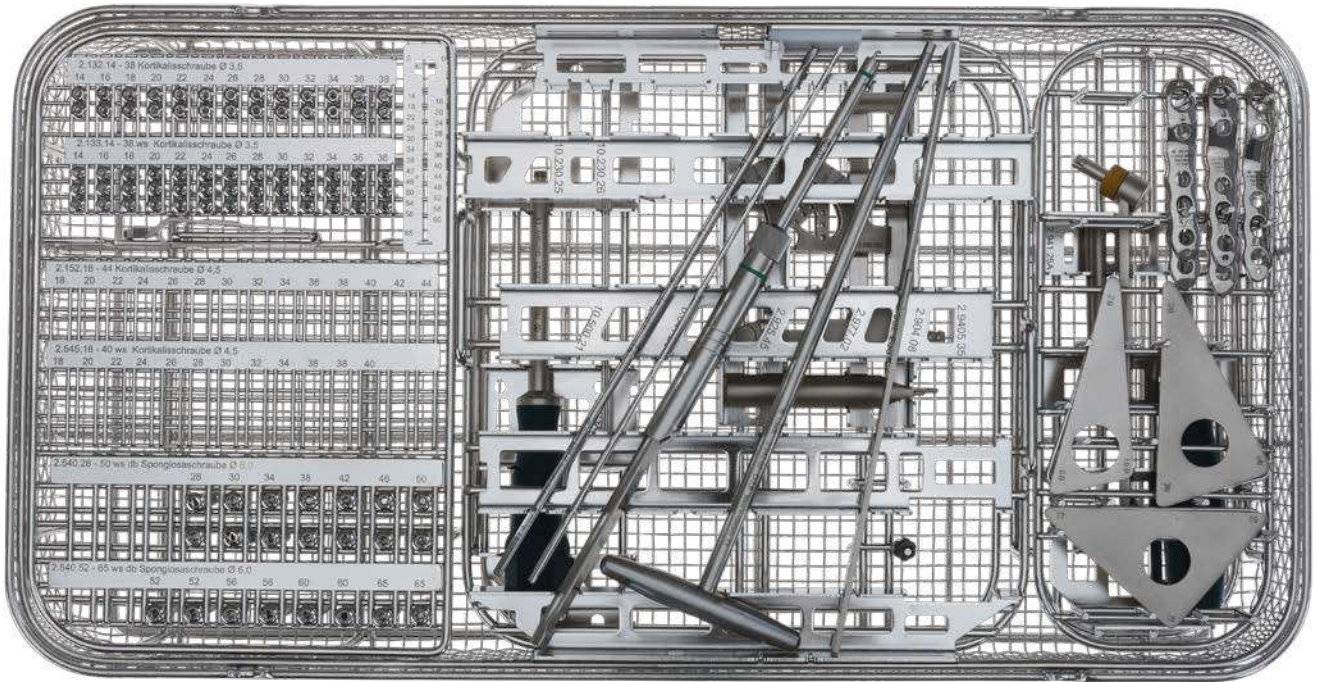

Set no. 19.561.10, upper level  Internal hexagon

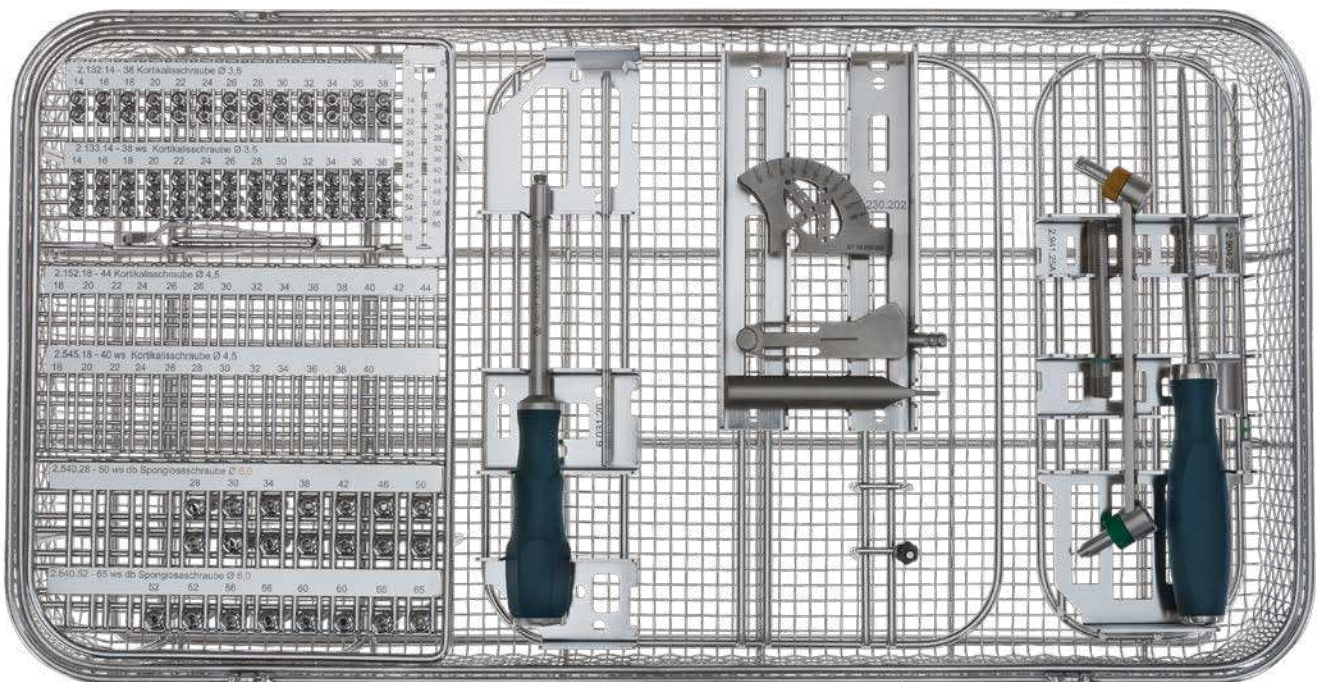

Set no. 19.561.10, lower level  Internal hexagon

WIRES

Königsee Implantate



Your Partner in Osteosynthesis

Guide wire









titanium



Item no. 3.983.20 guide wire with thread 10 mm



Item no. 3.989.16/01 guide wire with thread 30 mm on both sides

Item no.	Item description	EAN
3.981.12	guide wire; Ø 1,2 mm x 70 mm; thread 10 mm; titanium	 4047075101702
3.981.15	guide wire; Ø 1,5 mm x 70 mm; thread 10 mm; titanium	 4047075101726
3.981.18	guide wire; Ø 1,8 mm x 70 mm; thread 10 mm; titanium	 4047075101948
3.982.12	guide wire; Ø 1,2 mm x 150 mm; thread 10 mm; titanium	 4047075101757
3.982.14	guide wire; Ø 1,4 mm x 150 mm; thread 10 mm; titanium	 4047075101979
3.982.15	guide wire; Ø 1,5 mm x 150 mm; thread 10 mm; titanium	 4047075101870
3.982.16	guide wire; Ø 1,6 mm x 150 mm; thread 10 mm; titanium	 4047075101887
3.982.18	guide wire; Ø 1,8 mm x 150 mm; thread 10 mm; titanium	 4047075101894
3.982.20	guide wire; Ø 2,0 mm x 150 mm; thread 10 mm; titanium	 4047075101917
3.982.25	guide wire; Ø 2,5 mm x 150 mm; thread 10 mm; titanium	 4047075102013
3.982.30	guide wire; Ø 3,0 mm x 150 mm; thread 10 mm; titanium	 4047075102020
3.983.12	guide wire; Ø 1,2 mm x 230 mm; thread 10 mm; titanium	 4047075102037
3.983.14	guide wire; Ø 1,4 mm x 230 mm; thread 10 mm; titanium	 4047075102044
3.983.15	guide wire; Ø 1,5 mm x 230 mm; thread 10 mm; titanium	 4047075101924
3.983.16	guide wire; Ø 1,6 mm x 230 mm; thread 10 mm; titanium	 4047075101931
3.983.18	guide wire; Ø 1,8 mm x 230 mm; thread 10 mm; titanium	 4047075101962
3.983.20	guide wire; Ø 2,0 mm x 230 mm; thread 10 mm; titanium	 4047075102174
3.983.25	guide wire; Ø 2,5 mm x 230 mm; thread 10 mm; titanium	 4047075102181
3.983.30	guide wire; Ø 3,0 mm x 230 mm; thread 10 mm; titanium	 4047075102051
3.984.18	guide wire; Ø 1,8 mm x 300 mm; thread 10 mm; titanium	 4047075102068
3.984.20	guide wire; Ø 2,0 mm x 300 mm; thread 10 mm; titanium	 4047075102082
3.984.25	guide wire; Ø 2,5 mm x 300 mm; thread 10 mm; titanium	 4047075102105
3.984.30	guide wire; Ø 3,0 mm x 300 mm; thread 10 mm; titanium	 4047075102129
3.989.16/01	guide wire; Ø 1,6 mm x 150 mm; thread 30 mm; thread on both sides; titanium	 4047075102280

Guide wire

stainless steel



Item no. 2.978.20 guide wire with thread 5 mm















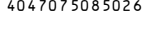









Item no.	Item description	EAN
2.976.12	guide wire; Ø 1,2 mm x 70 mm; thread 5 mm; stainless steel	 4047075084739
2.976.15	guide wire; Ø 1,5 mm x 70 mm; thread 5 mm; stainless steel	 4047075084623
2.976.18	guide wire; Ø 1,8 mm x 70 mm; thread 5 mm; stainless steel	 4047075084760
2.978.12	guide wire; Ø 1,2 mm x 150 mm; thread 5 mm; stainless steel	 4047075084791
2.978.14	guide wire; Ø 1,4 mm x 150 mm; thread 5 mm; stainless steel	 4047075149254
2.978.15	guide wire; Ø 1,5 mm x 150 mm; thread 5 mm; stainless steel	 4047075084685
2.978.16	guide wire; Ø 1,6 mm x 150 mm; thread 5 mm; stainless steel	 4047075084821
2.978.18	guide wire; Ø 1,8 mm x 150 mm; thread 5 mm; stainless steel	 4047075084715
2.978.20	guide wire; Ø 2,0 mm x 150 mm; thread 5 mm; stainless steel	 4047075084920
2.978.25	guide wire; Ø 2,5 mm x 150 mm; thread 5 mm; stainless steel	 4047075084937
2.978.30	guide wire; Ø 3,0 mm x 150 mm; thread 5 mm; stainless steel	 4047075084807
2.979.15	guide wire; Ø 1,5 mm x 230 mm; thread 5 mm; stainless steel	 4047075084814
2.979.18	guide wire; Ø 1,8 mm x 230 mm; thread 5 mm; stainless steel	 4047075084838
2.979.20	guide wire; Ø 2,0 mm x 230 mm; thread 5 mm; stainless steel	 4047075084845
2.979.25	guide wire; Ø 2,5 mm x 230 mm; thread 5 mm; stainless steel	 4047075084852
2.979.30	guide wire; Ø 3,0 mm x 230 mm; thread 5 mm; stainless steel	 4047075084869
2.980.18	guide wire; Ø 1,8 mm x 300 mm; thread 5 mm; stainless steel	 4047075085040
2.980.20	guide wire; Ø 2,0 mm x 300 mm; thread 5 mm; stainless steel	 4047075084968
2.980.25	guide wire; Ø 2,5 mm x 300 mm; thread 5 mm; stainless steel	 4047075084975
2.980.28	guide wire; Ø 2,8 mm x 300 mm; thread 5 mm; stainless steel	 4047075168514
2.980.28/450	guide wire; Ø 2,8 mm x 450 mm; thread 5 mm; stainless steel	 4047075170906
2.980.30	guide wire; Ø 3,0 mm x 300 mm; thread 5 mm; stainless steel	 4047075084982

Guide wire

stainless steel

Item no. 2.981.16 guide wire with thread 10 mm

Item no. 2.982.20 guide wire with thread 10 mm

Item no.	Item description	EAN
2.981.12	guide wire; Ø 1,2 mm x 70 mm; thread 10 mm; stainless steel	 4047075084876
2.981.14	guide wire; Ø 1,4 mm x 70 mm; thread 10 mm; stainless steel	 4047075084906
2.981.15	guide wire; Ø 1,5 mm x 70 mm; thread 10 mm; stainless steel	 4047075085057
2.981.16	guide wire; Ø 1,6 mm x 70 mm; thread 10 mm; stainless steel	 4047075084999
2.981.18	guide wire; Ø 1,8 mm x 70 mm; thread 10 mm; stainless steel	 4047075085002
2.981.20	guide wire; Ø 2,0 mm x 70 mm; thread 10 mm; stainless steel	 4047075085026
2.982.06	guide wire; Ø 0,6 mm x 150 mm; thread 10 mm; stainless steel	 4047075085095
2.982.12	guide wire; Ø 1,2 mm x 150 mm; thread 10 mm; stainless steel	 4047075085101
2.982.14	guide wire; Ø 1,4 mm x 150 mm; thread 10 mm; stainless steel	 4047075085224
2.982.15	guide wire; Ø 1,5 mm x 150 mm; thread 10 mm; stainless steel	 4047075085125
2.982.16	guide wire; Ø 1,6 mm x 150 mm; thread 10 mm; stainless steel	 4047075085156
2.982.18	guide wire; Ø 1,8 mm x 150 mm; thread 10 mm; stainless steel	 4047075085170
2.982.20	guide wire; Ø 2,0 mm x 150 mm; thread 10 mm; stainless steel	 4047075085248
2.982.25	guide wire; Ø 2,5 mm x 150 mm; thread 10 mm; stainless steel	 4047075085279
2.982.30	guide wire; Ø 3,0 mm x 150 mm; thread 10 mm; stainless steel	 4047075085194
2.982.32	guide wire; Ø 3,2 mm x 150 mm; thread 10 mm; stainless steel	 4047075085316
2.983.12	guide wire; Ø 1,2 mm x 230 mm; thread 10 mm; stainless steel	 4047075085217
2.983.14	guide wire; Ø 1,4 mm x 230 mm; thread 10 mm; stainless steel	 4047075085392
2.983.15	guide wire; Ø 1,5 mm x 230 mm; thread 10 mm; stainless steel	 4047075085408
2.983.16	guide wire; Ø 1,6 mm x 230 mm; thread 10 mm; stainless steel	 4047075085415
2.983.18	guide wire; Ø 1,8 mm x 230 mm; thread 10 mm; stainless steel	 4047075085293
2.983.20	guide wire; Ø 2,0 mm x 230 mm; thread 10 mm; stainless steel	 4047075085309
2.983.22	guide wire; Ø 2,2 mm x 230 mm; thread 10 mm; stainless steel	 4047075085323
2.983.25	guide wire; Ø 2,5 mm x 230 mm; thread 10 mm; stainless steel	 4047075085330
2.983.30	guide wire; Ø 3,0 mm x 230 mm; thread 10 mm; stainless steel	 4047075085347

Guide wire

stainless steel



Item no. 2.984.20 guide wire with thread 10 mm



Item no. 2.989.16 guide wire with thread 10 mm on both sides

Item no.	Item description	EAN
2.984.12	guide wire; Ø 1,2 mm x 300 mm; thread 10 mm; stainless steel	 4047075085354
2.984.12/400	guide wire; Ø 1,2 mm x 400 mm; thread 10 mm; stainless steel	 4047075155019
2.984.16	guide wire; Ø 1,6 mm x 300 mm; thread 10 mm; stainless steel	 4047075085422
2.984.18	guide wire; Ø 1,8 mm x 300 mm; thread 10 mm; stainless steel	 4047075085552
2.984.20	guide wire; Ø 2,0 mm x 300 mm; thread 10 mm; stainless steel	 4047075085439
2.984.20/400	guide wire; Ø 2,0 mm x 400 mm; thread 10 mm; stainless steel	 4047075085446
2.984.20/500	guide wire; Ø 2,0 mm x 500 mm; thread 10 mm; stainless steel	 4047075138609
2.984.25	guide wire; Ø 2,5 mm x 300 mm; thread 10 mm; stainless steel	 4047075085453
2.984.25/350	guide wire; Ø 2,5 mm x 350 mm; thread 10 mm; stainless steel	 4047075085460
2.984.25/400	guide wire; Ø 2,5 mm x 400 mm; thread 10 mm; stainless steel	 4047075085477
2.984.25/500	guide wire; Ø 2,5 mm x 500 mm; thread 10 mm; stainless steel	 4047075138616
2.984.30	guide wire; Ø 3,0 mm x 300 mm; thread 10 mm; stainless steel	 4047075085361
2.984.30/400	guide wire; Ø 3,0 mm x 400 mm; thread 10 mm; stainless steel	 4047075147984
2.988.20/310	guide wire; Ø 2,0 mm x 310 mm; thread 15 mm; stainless steel	 4047075121359
2.989.16	guide wire; Ø 1,6 mm x 170 mm; thread 10 mm; thread on both sides; stainless steel	 4047075085880



Wires

Compression wire

Stainless steel



Item no. 2.919.18/15













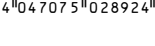

Item no.	Item description	EAN
2.919.18/05	Compression wire; Ø 1.2 mm / Ø 1.8 x 150 mm; thread distance 5; Ø 1.0 x 50 mm; stainless steel	 4 047075 164288
2.919.18/10	Compression wire; Ø 1.2 mm / Ø 1.8 x 150 mm; thread distance 10; Ø 1.0 x 50 mm; stainless steel	 4 047075 162024
2.919.18/15	Compression wire; Ø 1.2 mm / Ø 1.8 x 150 mm; thread distance 15; Ø 1.0 x 50 mm; stainless steel	 4 047075 162031

Kirschner wire

titanium



Item no. 7.031.20 Kirschner wire with trocar point and round end

Item no.	Item description	EAN
Kirschner wire with trocar point and round end		
Kirschner wire with trocar point and round end; 70 mm length		
7.011.10	Kirschner wire with trocar point and round end; Ø 1,0 mm x 70 mm; titanium	 4 047075 028849
7.011.12	Kirschner wire with trocar point and round end; Ø 1,2 mm x 70 mm; titanium	 4 047075 028856
7.011.14	Kirschner wire with trocar point and round end; Ø 1,4 mm x 70 mm; titanium	 4 047075 028870
7.011.15	Kirschner wire with trocar point and round end; Ø 1,5 mm x 70 mm; titanium	 4 047075 028696
7.011.16	Kirschner wire with trocar point and round end; Ø 1,6 mm x 70 mm; titanium	 4 047075 028702
7.011.18	Kirschner wire with trocar point and round end; Ø 1,8 mm x 70 mm; titanium	 4 047075 028719
7.011.20	Kirschner wire with trocar point and round end; Ø 2,0 mm x 70 mm; titanium	 4 047075 028726
7.011.25	Kirschner wire with trocar point and round end; Ø 2,5 mm x 70 mm; titanium	 4 047075 028863
7.011.30	Kirschner wire with trocar point and round end; Ø 3,0 mm x 70 mm; titanium	 4 047075 028924
Kirschner wire with trocar point and round end; 120 mm length		
7.021.10	Kirschner wire with trocar point and round end; Ø 1,0 mm x 120 mm; titanium	 4 047075 029143
7.021.12	Kirschner wire with trocar point and round end; Ø 1,2 mm x 120 mm; titanium	 4 047075 028962
7.021.14	Kirschner wire with trocar point and round end; Ø 1,4 mm x 120 mm; titanium	 4 047075 028917
7.021.15	Kirschner wire with trocar point and round end; Ø 1,5 mm x 120 mm; titanium	 4 047075 028993
7.021.16	Kirschner wire with trocar point and round end; Ø 1,6 mm x 120 mm; titanium	 4 047075 029006
7.021.20	Kirschner wire with trocar point and round end; Ø 2,0 mm x 120 mm; titanium	 4 047075 029211

Kirschner wire

titanium



Item no. 7.031.20 Kirschner wire with trocar point and round end

Item no.	Item description	EAN
Kirschner wire with trocar point and round end; 150 mm length		
7.031.10	Kirschner wire with trocar point and round end; Ø 1,0 mm x 150 mm; titanium	4 ⁰ 047075 ⁰ 029402
7.031.12	Kirschner wire with trocar point and round end; Ø 1,2 mm x 150 mm; titanium	4 ⁰ 047075 ⁰ 029426
7.031.14	Kirschner wire with trocar point and round end; Ø 1,4 mm x 150 mm; titanium	4 ⁰ 047075 ⁰ 029440
7.031.15	Kirschner wire with trocar point and round end; Ø 1,5 mm x 150 mm; titanium	4 ⁰ 047075 ⁰ 029273
7.031.16	Kirschner wire with trocar point and round end; Ø 1,6 mm x 150 mm; titanium	4 ⁰ 047075 ⁰ 029280
7.031.18	Kirschner wire with trocar point and round end; Ø 1,8 mm x 150 mm; titanium	4 ⁰ 047075 ⁰ 029303
7.031.20	Kirschner wire with trocar point and round end; Ø 2,0 mm x 150 mm; titanium	4 ⁰ 047075 ⁰ 029433
7.031.25	Kirschner wire with trocar point and round end; Ø 2,5 mm x 150 mm; titanium	4 ⁰ 047075 ⁰ 029525
7.031.30	Kirschner wire with trocar point and round end; Ø 3,0 mm x 150 mm; titanium	4 ⁰ 047075 ⁰ 029532
7.031.32	Kirschner wire with trocar point and round end; Ø 3,2 mm x 150 mm; titanium	4 ⁰ 047075 ⁰ 029549
7.031.40	Kirschner wire with trocar point and round end; Ø 4,0 mm x 150 mm; titanium	4 ⁰ 047075 ⁰ 029365
Kirschner wire with trocar point and round end; 160 mm length		
7.031.10/160	Kirschner wire with trocar point and round end; Ø 1,0 mm x 160 mm; titanium	4 ⁰ 047075 ⁰ 029419
7.031.12/160	Kirschner wire with trocar point and round end; Ø 1,2 mm x 160 mm; titanium	4 ⁰ 047075 ⁰ 029167
7.031.14/160	Kirschner wire with trocar point and round end; Ø 1,4 mm x 160 mm; titanium	4 ⁰ 047075 ⁰ 029266
7.031.16/160	Kirschner wire with trocar point and round end; Ø 1,6 mm x 160 mm; titanium	4 ⁰ 047075 ⁰ 029297
7.031.18/160	Kirschner wire with trocar point and round end; Ø 1,8 mm x 160 mm; titanium	4 ⁰ 047075 ⁰ 029495
7.031.20/160	Kirschner wire with trocar point and round end; Ø 2,0 mm x 160 mm; titanium	4 ⁰ 047075 ⁰ 029518

Kirschner wire

titanium



Item no. 6.011.10 Kirschner wire with trocar point and round end

Item no.	Item description	EAN
Kirschner wire with trocar point and round end; 220 mm length		
7.041.10	Kirschner wire with trocar point and round end; Ø 1,0 mm x 220 mm; titanium	4 ⁰ 047075 ⁰ 029570
7.041.12	Kirschner wire with trocar point and round end; Ø 1,2 mm x 220 mm; titanium	4 ⁰ 047075 ⁰ 029587
7.041.14	Kirschner wire with trocar point and round end; Ø 1,4 mm x 220 mm; titanium	4 ⁰ 047075 ⁰ 029778
7.041.15	Kirschner wire with trocar point and round end; Ø 1,5 mm x 220 mm; titanium	4 ⁰ 047075 ⁰ 029785
7.041.16	Kirschner wire with trocar point and round end; Ø 1,6 mm x 220 mm; titanium	4 ⁰ 047075 ⁰ 029792
7.041.18	Kirschner wire with trocar point and round end; Ø 1,8 mm x 220 mm; titanium	4 ⁰ 047075 ⁰ 029563
7.041.20	Kirschner wire with trocar point and round end; Ø 2,0 mm x 220 mm; titanium	4 ⁰ 047075 ⁰ 029815
7.041.25	Kirschner wire with trocar point and round end; Ø 2,5 mm x 220 mm; titanium	4 ⁰ 047075 ⁰ 029648
7.041.30	Kirschner wire with trocar point and round end; Ø 3,0 mm x 220 mm; titanium	4 ⁰ 047075 ⁰ 029655
Kirschner wire with trocar point and round end; 280 mm length		
7.061.10	Kirschner wire with trocar point and round end; Ø 1,0 mm x 280 mm; titanium	4 ⁰ 047075 ⁰ 030378
7.061.12	Kirschner wire with trocar point and round end; Ø 1,2 mm x 280 mm; titanium	4 ⁰ 047075 ⁰ 030385
7.061.14	Kirschner wire with trocar point and round end; Ø 1,4 mm x 280 mm; titanium	4 ⁰ 047075 ⁰ 030132
7.061.15	Kirschner wire with trocar point and round end; Ø 1,5 mm x 280 mm; titanium	4 ⁰ 047075 ⁰ 030149
7.061.16	Kirschner wire with trocar point and round end; Ø 1,6 mm x 280 mm; titanium	4 ⁰ 047075 ⁰ 030415
7.061.18	Kirschner wire with trocar point and round end; Ø 1,8 mm x 280 mm; titanium	4 ⁰ 047075 ⁰ 030224
7.061.20	Kirschner wire with trocar point and round end; Ø 2,0 mm x 280 mm; titanium	4 ⁰ 047075 ⁰ 030231
7.061.25	Kirschner wire with trocar point and round end; Ø 2,5 mm x 280 mm; titanium	4 ⁰ 047075 ⁰ 030248
7.061.30	Kirschner wire with trocar point and round end; Ø 3,0 mm x 280 mm; titanium	4 ⁰ 047075 ⁰ 030453

Kirschner wire

titanium



Item no. 7.031.20 Kirschner wire with trocar point and round end

Item no.	Item description	EAN
Kirschner wire with trocar point and round end; 310 mm length		
7.051.10	Kirschner wire with trocar point and round end; Ø 1,0 mm x 310 mm; titanium	4 047075 030057
7.051.12	Kirschner wire with trocar point and round end; Ø 1,2 mm x 310 mm; titanium	4 047075 029990
7.051.14	Kirschner wire with trocar point and round end; Ø 1,4 mm x 310 mm; titanium	4 047075 030088
7.051.15	Kirschner wire with trocar point and round end; Ø 1,5 mm x 310 mm; titanium	4 047075 030095
7.051.16	Kirschner wire with trocar point and round end; Ø 1,6 mm x 310 mm; titanium	4 047075 030118
7.051.18	Kirschner wire with trocar point and round end; Ø 1,8 mm x 310 mm; titanium	4 047075 029921
7.051.20	Kirschner wire with trocar point and round end; Ø 2,0 mm x 310 mm; titanium	4 047075 029945
7.051.25	Kirschner wire with trocar point and round end; Ø 2,5 mm x 310 mm; titanium	4 047075 030163
7.051.30	Kirschner wire with trocar point and round end; Ø 3,0 mm x 310 mm; titanium	4 047075 030187
7.051.40	Kirschner wire with trocar point and round end; Ø 4,0 mm x 310 mm; titanium	4 047075 029938
Kirschner wire with trocar point and round end; special lengths		
7.051.15/300	Kirschner wire with trocar point and round end; Ø 1,5 mm x 300 mm; titanium	4 047075 030101
7.051.25/400	Kirschner wire with trocar point and round end; Ø 2,5 mm x 400 mm; titanium	4 047075 116393
7.051.25/420	Kirschner wire with trocar point and round end; Ø 2,5 mm x 420 mm; titanium	4 047075 030170
7.051.18/450	Kirschner wire with trocar point and round end; Ø 1,8 mm x 450 mm; titanium	4 047075 029860

Kirschner wire

titanium



Item no. 7.032.20 Kirschner wire with trocar point on both sides

Item no.	Item description	EAN
Kirschner wire with trocar point on both sides		
Kirschner wire with trocar point on both sides; 70 mm length		
7.012.10	Kirschner wire with trocar point on both sides; Ø 1,0 mm x 70 mm; titanium	4 047075 028795
7.012.12	Kirschner wire with trocar point on both sides; Ø 1,2 mm x 70 mm; titanium	4 047075 028733
7.012.14	Kirschner wire with trocar point on both sides; Ø 1,4 mm x 70 mm; titanium	4 047075 028818
7.012.15	Kirschner wire with trocar point on both sides; Ø 1,5 mm x 70 mm; titanium	4 047075 029013
Kirschner wire with trocar point on both sides; 120 mm length		
7.022.10	Kirschner wire with trocar point on both sides; Ø 1,0 mm x 120 mm; titanium	4 047075 029228
7.022.12	Kirschner wire with trocar point on both sides; Ø 1,2 mm x 120 mm; titanium	4 047075 029235
7.022.14	Kirschner wire with trocar point on both sides; Ø 1,4 mm x 120 mm; titanium	4 047075 029259
7.022.15	Kirschner wire with trocar point on both sides; Ø 1,5 mm x 120 mm; titanium	4 047075 029075
7.022.16	Kirschner wire with trocar point on both sides; Ø 1,6 mm x 120 mm; titanium	4 047075 029082
7.022.18	Kirschner wire with trocar point on both sides; Ø 1,8 mm x 120 mm; titanium	4 047075 029099
7.022.20	Kirschner wire with trocar point on both sides; Ø 2,0 mm x 120 mm; titanium	4 047075 029105
Kirschner wire with trocar point on both sides; 150 mm length		
7.032.10	Kirschner wire with trocar point on both sides; Ø 1,0 mm x 150 mm; titanium	4 047075 029310
7.032.12	Kirschner wire with trocar point on both sides; Ø 1,2 mm x 150 mm; titanium	4 047075 029372
7.032.14	Kirschner wire with trocar point on both sides; Ø 1,4 mm x 150 mm; titanium	4 047075 029594
7.032.15	Kirschner wire with trocar point on both sides; Ø 1,5 mm x 150 mm; titanium	4 047075 029600
7.032.16	Kirschner wire with trocar point on both sides; Ø 1,6 mm x 150 mm; titanium	4 047075 029617
7.032.18	Kirschner wire with trocar point on both sides; Ø 1,8 mm x 150 mm; titanium	4 047075 029624
7.032.20	Kirschner wire with trocar point on both sides; Ø 2,0 mm x 150 mm; titanium	4 047075 029631
7.032.25	Kirschner wire with trocar point on both sides; Ø 2,5 mm x 150 mm; titanium	4 047075 029457
7.032.30	Kirschner wire with trocar point on both sides; Ø 3,0 mm x 150 mm; titanium	4 047075 029464

Kirschner wire

titanium



Item no. 7.032.20 Kirschner wire with trocar point on both sides

Item no.	Item description	EAN
Kirschner wire with trocar point on both sides; 220 mm length		
7.042.10	Kirschner wire with trocar point on both sides; Ø 1,0 mm x 220 mm; titanium	4 047075 029853
7.042.12	Kirschner wire with trocar point on both sides; Ø 1,2 mm x 220 mm; titanium	4 047075 029808
7.042.14	Kirschner wire with trocar point on both sides; Ø 1,4 mm x 220mm; titanium	4 047075 029884
7.042.16	Kirschner wire with trocar point on both sides; Ø 1,6 mm x 220 mm; titanium	4 047075 029907
7.042.18	Kirschner wire with trocar point on both sides; Ø 1,8 mm x 220 mm; titanium	4 047075 029914
7.042.20	Kirschner wire with trocar point on both sides; Ø 2,0 mm x 220 mm; titanium	4 047075 029730
Kirschner wire with trocar point on both sides; 280 mm length		
7.062.10	Kirschner wire with trocar point on both sides; Ø 1,0 mm x 280 mm; titanium	4 047075 030408
7.062.12	Kirschner wire with trocar point on both sides; Ø 1,2 mm x 280 mm; titanium	4 047075 030460
7.062.14	Kirschner wire with trocar point on both sides; Ø 1,4 mm x 280 mm; titanium	4 047075 030477

Kirschner wire

stainless steel















Item no. 6.011.10 Kirschner wire with trocar point and round end









Item no.	Item description	EAN
----------	------------------	-----

Kirschner wire with trocar point and round end

Kirschner wire with trocar point and round end; 70 mm length

6.011.06	Kirschner wire with trocar point and round end, Ø 0.6 mm x 70 mm, stainless steel	
6.011.08	Kirschner wire with trocar point and round end, Ø 0.8 mm x 70 mm, stainless steel	
6.011.10	Kirschner wire with trocar point and round end, Ø 1.0 mm x 70 mm, stainless steel	
6.011.12	Kirschner wire with trocar point and round end, Ø 1.2 mm x 70 mm, stainless steel	
6.011.14	Kirschner wire with trocar point and round end, Ø 1.4 mm x 70 mm, stainless steel	
6.011.15	Kirschner wire with trocar point and round end, Ø 1.5 mm x 70 mm, stainless steel	
6.011.16	Kirschner wire with trocar point and round end, Ø 1.6 mm x 70 mm, stainless steel	
6.011.18	Kirschner wire with trocar point and round end, Ø 1.8 mm x 70 mm, stainless steel	
6.011.20	Kirschner wire with trocar point and round end, Ø 2.0 mm x 70 mm, stainless steel	
6.011.22	Kirschner wire with trocar point and round end, Ø 2.2 mm x 70 mm, stainless steel	
6.011.25	Kirschner wire with trocar point and round end, Ø 2.5 mm x 70 mm, stainless steel	
6.011.30	Kirschner wire with trocar point and round end, Ø 3.0 mm x 70 mm, stainless steel	

Kirschner wire with trocar point and round end; 120 mm length

6.021.06	Kirschner wire with trocar point and round end, Ø 0.6 mm x 120 mm, stainless steel	
6.021.08	Kirschner wire with trocar point and round end, Ø 0.8 mm x 120 mm, stainless steel	
6.021.10	Kirschner wire with trocar point and round end, Ø 1.0 mm x 120 mm, stainless steel	
6.021.12	Kirschner wire with trocar point and round end, Ø 1.2 mm x 120 mm, stainless steel	
6.021.14	Kirschner wire with trocar point and round end, Ø 1.4 mm x 120 mm, stainless steel	
6.021.15	Kirschner wire with trocar point and round end, Ø 1.5 mm x 120 mm, stainless steel	
6.021.16	Kirschner wire with trocar point and round end, Ø 1.6 mm x 120 mm, stainless steel	
6.021.18	Kirschner wire with trocar point and round end, Ø 1.8 mm x 120 mm, stainless steel	
6.021.20	Kirschner wire with trocar point and round end, Ø 2.0 mm x 120 mm, stainless steel	

Kirschner wire

stainless steel



Item no. 6.011.10 Kirschner wire with trocar point and round end

Item no.	Item description	EAN
----------	------------------	-----

Kirschner wire with trocar point and round end; 150 mm length

6.031.06	Kirschner wire with trocar point and round end, Ø 0.6 mm x 150 mm, stainless steel	4 047075 013128
6.031.08	Kirschner wire with trocar point and round end, Ø 0.8 mm x 150 mm, stainless steel	4 047075 013067
6.031.10	Kirschner wire with trocar point and round end, Ø 1.0 mm x 150 mm, stainless steel	4 047075 013159
6.031.12	Kirschner wire with trocar point and round end, Ø 1.2 mm x 150 mm, stainless steel	4 047075 013166
6.031.14	Kirschner wire with trocar point and round end, Ø 1.4 mm x 150 mm, stainless steel	4 047075 013173
6.031.15	Kirschner wire with trocar point and round end, Ø 1.5 mm x 150 mm, stainless steel	4 047075 012947
6.031.16	Kirschner wire with trocar point and round end, Ø 1.6 mm x 150 mm, stainless steel	4 047075 012954
6.031.18	Kirschner wire with trocar point and round end, Ø 1.8 mm x 150 mm, stainless steel	4 047075 013210
6.031.20	Kirschner wire with trocar point and round end, Ø 2.0 mm x 150 mm, stainless steel	4 047075 013227
6.031.22	Kirschner wire with trocar point and round end, Ø 2.2 mm x 150 mm, stainless steel	4 047075 013234
6.031.25	Kirschner wire with trocar point and round end, Ø 2.5 mm x 150 mm, stainless steel	4 047075 013180
6.031.30	Kirschner wire with trocar point and round end, Ø 3.0 mm x 150 mm, stainless steel	4 047075 013012
6.031.32	Kirschner wire with trocar point and round end, Ø 3.2 mm x 150 mm, stainless steel	4 047075 013265

Kirschner wire with trocar point and round end; 220 mm length

6.041.08	Kirschner wire with trocar point and round end, Ø 0.8 mm x 220 mm, stainless steel	4 047075 013715
6.041.10	Kirschner wire with trocar point and round end, Ø 1.0 mm x 220 mm, stainless steel	4 047075 013517
6.041.12	Kirschner wire with trocar point and round end, Ø 1.2 mm x 220 mm, stainless steel	4 047075 013739
6.041.14	Kirschner wire with trocar point and round end, Ø 1.4 mm x 220 mm, stainless steel	4 047075 013746
6.041.15	Kirschner wire with trocar point and round end, Ø 1.5 mm x 220 mm, stainless steel	4 047075 013616
6.041.16	Kirschner wire with trocar point and round end, Ø 1.6 mm x 220 mm, stainless steel	4 047075 013777
6.041.18	Kirschner wire with trocar point and round end, Ø 1.8 mm x 220 mm, stainless steel	4 047075 013722
6.041.20	Kirschner wire with trocar point and round end, Ø 2.0 mm x 220 mm, stainless steel	4 047075 013807
6.041.22	Kirschner wire with trocar point and round end, Ø 2.2 mm x 220 mm, stainless steel	4 047075 013838
6.041.25	Kirschner wire with trocar point and round end, Ø 2.5 mm x 220 mm, stainless steel	4 047075 013845
6.041.30	Kirschner wire with trocar point and round end, Ø 3.0 mm x 220 mm, stainless steel	4 047075 013623

Kirschner wire

stainless steel



Item no. 6.011.10 Kirschner wire with trocar point and round end















Item no.	Item description	EAN
Kirschner wire with trocar point and round end; 280 mm length		
6.061.08	Kirschner wire with trocar point and round end, Ø 0.8 mm x 280 mm, stainless steel	4 047075 014965
6.061.10	Kirschner wire with trocar point and round end, Ø 1.0 mm x 280 mm, stainless steel	4 047075 015030
6.061.12	Kirschner wire with trocar point and round end, Ø 1.2 mm x 280 mm, stainless steel	4 047075 015047
6.061.14	Kirschner wire with trocar point and round end, Ø 1.4 mm x 280 mm, stainless steel	4 047075 015054
6.061.15	Kirschner wire with trocar point and round end, Ø 1.5 mm x 280 mm, stainless steel	4 047075 015061
6.061.16	Kirschner wire with trocar point and round end, Ø 1.6 mm x 280 mm, stainless steel	4 047075 014859
6.061.18	Kirschner wire with trocar point and round end, Ø 1.8 mm x 280 mm, stainless steel	4 047075 014910
6.061.20	Kirschner wire with trocar point and round end, Ø 2.0 mm x 280 mm, stainless steel	4 047075 015092
6.061.22	Kirschner wire with trocar point and round end, Ø 2.2 mm x 280 mm, stainless steel	4 047075 015108
6.061.24	Kirschner wire with trocar point and round end, Ø 2.4 mm x 280 mm, stainless steel	4 047075 061655
6.061.25	Kirschner wire with trocar point and round end, Ø 2.5 mm x 280 mm, stainless steel	4 047075 015115
6.061.30	Kirschner wire with trocar point and round end, Ø 3.0 mm x 280 mm, stainless steel	4 047075 015078
Kirschner wire with trocar point and round end; 310 mm length		
6.051.08	Kirschner wire with trocar point and round end, Ø 0.8 mm x 310 mm, stainless steel	4 047075 014194
6.051.10	Kirschner wire with trocar point and round end, Ø 1.0 mm x 310 mm, stainless steel	4 047075 014422
6.051.12	Kirschner wire with trocar point and round end, Ø 1.2 mm x 310 mm, stainless steel	4 047075 014293
6.051.14	Kirschner wire with trocar point and round end, Ø 1.4 mm x 310 mm, stainless steel	4 047075 014460
6.051.15	Kirschner wire with trocar point and round end, Ø 1.5 mm x 310 mm, stainless steel	4 047075 014408
6.051.16	Kirschner wire with trocar point and round end, Ø 1.6 mm x 310 mm, stainless steel	4 047075 014484
6.051.18	Kirschner wire with trocar point and round end, Ø 1.8 mm x 310 mm, stainless steel	4 047075 014491
6.051.20	Kirschner wire with trocar point and round end, Ø 2.0 mm x 310 mm, stainless steel	4 047075 014507
6.051.22	Kirschner wire with trocar point and round end, Ø 2.2 mm x 310 mm, stainless steel	4 047075 014378
6.051.25	Kirschner wire with trocar point and round end, Ø 2.5 mm x 310 mm, stainless steel	4 047075 014545
6.051.30	Kirschner wire with trocar point and round end, Ø 3.0 mm x 310 mm, stainless steel	4 047075 014569
6.051.35	Kirschner wire with trocar point and round end, Ø 3.5 mm x 310 mm, stainless steel	4 047075 120420

Kirschner wire

stainless steel



Item no. 6.011.10 Kirschner wire with trocar point and round end

Item no.	Item description	EAN
Kirschner wire with trocar point and round end; 420 mm length		
6.299.00	Kirschner wire with trocar point and round end, Ø 2.5 mm x 420 mm, stainless steel	
6.299.20	Kirschner wire with trocar point and round end, Ø 2.0 mm x 420 mm, stainless steel	
Kirschner wire with trocar point and round end; special lengths		
6.021.16/100	Kirschner wire with trocar point and round end, Ø 1.6 mm x 100 mm, stainless steel	
6.031.16/130	Kirschner wire with trocar point and round end, Ø 1.6 mm x 130 mm, stainless steel	
6.041.25/180	Kirschner wire with trocar point and round end, Ø 2.5 mm x 180 mm, stainless steel	
6.041.20/230	Kirschner wire with trocar point and round end, Ø 2.0 mm x 230 mm, stainless steel	
6.031.30/270	Kirschner wire with trocar point and round end Ø 3.0 mm x 270 mm f. RoSA, stainless steel	
6.031.30/320	Kirschner wire with trocar point and marking Ø 3.0 mm x 320 mm f. RoSA, stainless steel	
6.031.30/400	Kirschner wire with trocar point and round end Ø 3.0 mm x 400 mm f. RoSA, stainless steel	
6.051.10/450	Kirschner wire with trocar point and round end, Ø 1.0 mm x 450 mm, stainless steel	
6.051.12/480	Kirschner wire with trocar point and round end, Ø 1.2 mm x 480 mm, stainless steel	
6.051.14/480	Kirschner wire with trocar point and round end, Ø 1.4 mm x 480 mm, stainless steel	
6.051.15/480	Kirschner wire with trocar point and round end, Ø 1.5 mm x 480 mm, stainless steel	
6.051.25/500	Kirschner wire with trocar point and round end, Ø 2.5 mm x 500 mm, stainless steel	
6.051.30/500	Kirschner wire with trocar point and round end, Ø 3.0 mm x 500 mm, stainless steel	

Kirschner wire

stainless steel



Item no. 6.032.20 Kirschner wire with trocar point on both sides

Item no.	Item description	EAN
----------	------------------	-----

Kirschner wire with trocar point on both sides

Kirschner wire with trocar point on both sides; 70 mm length

6.012.06	Kirschner wire with trocar point on both sides, Ø 0.6 mm x 70 mm, stainless steel	4 047075 012077
6.012.08	Kirschner wire with trocar point on both sides, Ø 0.8 mm x 70 mm, stainless steel	4 047075 011889
6.012.10	Kirschner wire with trocar point on both sides, Ø 1.0 mm x 70 mm, stainless steel	4 047075 012091
6.012.12	Kirschner wire with trocar point on both sides, Ø 1.2 mm x 70 mm, stainless steel	4 047075 012107
6.012.14	Kirschner wire with trocar point on both sides, Ø 1.4 mm x 70 mm, stainless steel	4 047075 011957
6.012.15	Kirschner wire with trocar point on both sides, Ø 1.5 mm x 70 mm, stainless steel	4 047075 012121
6.012.16	Kirschner wire with trocar point on both sides, Ø 1.6 mm x 70 mm, stainless steel	4 047075 012084
6.012.18	Kirschner wire with trocar point on both sides, Ø 1.8 mm x 70 mm, stainless steel	4 047075 012152
6.012.20	Kirschner wire with trocar point on both sides, Ø 2.0 mm x 70 mm, stainless steel	4 047075 012189
6.012.22	Kirschner wire with trocar point on both sides, Ø 2.2 mm x 70 mm, stainless steel	4 047075 012176
6.012.30	Kirschner wire with trocar point on both sides, Ø 3.0 mm x 70 mm, stainless steel	4 047075 011971

Kirschner wire with trocar point on both sides; 120 mm length

6.022.06	Kirschner wire with trocar point on both sides, Ø 0.6 mm x 120 mm, stainless steel	4 047075 012633
6.022.08	Kirschner wire with trocar point on both sides, Ø 0.8 mm x 120 mm, stainless steel	4 047075 012640
6.022.10	Kirschner wire with trocar point on both sides, Ø 1.0 mm x 120 mm, stainless steel	4 047075 012657
6.022.12	Kirschner wire with trocar point on both sides, Ø 1.2 mm x 120 mm, stainless steel	4 047075 012671
6.022.14	Kirschner wire with trocar point on both sides, Ø 1.4 mm x 120 mm, stainless steel	4 047075 012459
6.022.15	Kirschner wire with trocar point on both sides, Ø 1.5 mm x 120 mm, stainless steel	4 047075 012510
6.022.16	Kirschner wire with trocar point on both sides, Ø 1.6 mm x 120 mm, stainless steel	4 047075 012718
6.022.18	Kirschner wire with trocar point on both sides, Ø 1.8 mm x 120 mm, stainless steel	4 047075 012725
6.022.20	Kirschner wire with trocar point on both sides, Ø 2.0 mm x 120 mm, stainless steel	4 047075 012732
6.022.22	Kirschner wire with trocar point on both sides, Ø 2.2 mm x 120 mm, stainless steel	4 047075 012688
6.022.25	Kirschner wire with trocar point on both sides, Ø 2.5 mm x 120 mm, stainless steel	4 047075 012503
6.022.30	Kirschner wire with trocar point on both sides, Ø 3.0 mm x 120 mm, stainless steel	4 047075 012756

Kirschner wire

stainless steel



Item no. 6.032.20 Kirschner wire with trocar point on both sides

Item no.	Item description	EAN
Kirschner wire with trocar point on both sides; 150 mm length		
6.032.06	Kirschner wire with trocar point on both sides, Ø 0.6 mm x 150 mm, stainless steel	4 047075 013272
6.032.08	Kirschner wire with trocar point on both sides, Ø 0.8 mm x 150 mm, stainless steel	4 047075 013104
6.032.10	Kirschner wire with trocar point on both sides, Ø 1.0 mm x 150 mm, stainless steel	4 047075 013111
6.032.12	Kirschner wire with trocar point on both sides, Ø 1.2 mm x 150 mm, stainless steel	4 047075 013241
6.032.14	Kirschner wire with trocar point on both sides, Ø 1.4 mm x 150 mm, stainless steel	4 047075 013258
6.032.15	Kirschner wire with trocar point on both sides, Ø 1.5 mm x 150 mm, stainless steel	4 047075 013319
6.032.16	Kirschner wire with trocar point on both sides, Ø 1.6 mm x 150 mm, stainless steel	4 047075 013326
6.032.18	Kirschner wire with trocar point on both sides, Ø 1.8 mm x 150 mm, stainless steel	4 047075 013333
6.032.20	Kirschner wire with trocar point on both sides, Ø 2.0 mm x 150 mm, stainless steel	4 047075 013340
6.032.22	Kirschner wire with trocar point on both sides, Ø 2.2 mm x 150 mm, stainless steel	4 047075 013135
6.032.25	Kirschner wire with trocar point on both sides, Ø 2.5 mm x 150 mm, stainless steel	4 047075 013203
6.032.30	Kirschner wire with trocar point on both sides, Ø 3.0 mm x 150 mm, stainless steel	4 047075 013371
Kirschner wire with trocar point on both sides; 220 mm length		
6.042.08	Kirschner wire with trocar point on both sides, Ø 0.8 mm x 220 mm, stainless steel	4 047075 013630
6.042.10	Kirschner wire with trocar point on both sides, Ø 1.0 mm x 220 mm, stainless steel	4 047075 013883
6.042.12	Kirschner wire with trocar point on both sides, Ø 1.2 mm x 220 mm, stainless steel	4 047075 013890
6.042.14	Kirschner wire with trocar point on both sides, Ø 1.4 mm x 220 mm, stainless steel	4 047075 013906
6.042.15	Kirschner wire with trocar point on both sides, Ø 1.5 mm x 220 mm, stainless steel	4 047075 013913
6.042.16	Kirschner wire with trocar point on both sides, Ø 1.6 mm x 220 mm, stainless steel	4 047075 013685
6.042.18	Kirschner wire with trocar point on both sides, Ø 1.8 mm x 220 mm, stainless steel	4 047075 013937
6.042.20	Kirschner wire with trocar point on both sides, Ø 2.0 mm x 220 mm, stainless steel	4 047075 013753
6.042.22	Kirschner wire with trocar point on both sides, Ø 2.2 mm x 220 mm, stainless steel	4 047075 013760
6.042.25	Kirschner wire with trocar point on both sides, Ø 2.5 mm x 220 mm, stainless steel	4 047075 013920
6.042.30	Kirschner wire with trocar point on both sides, Ø 3.0 mm x 220 mm, stainless steel	4 047075 013999

Kirschner wire

stainless steel



Item no. 6.032.20 Kirschner wire with trocar point on both sides

Item no.	Item description	EAN
----------	------------------	-----

Kirschner wire with trocar point on both sides; 280 mm length

6.062.10	Kirschner wire with trocar point on both sides, Ø 1.0 mm x 280 mm, stainless steel	4 047075 014903
6.062.12	Kirschner wire with trocar point on both sides, Ø 1.2 mm x 280 mm, stainless steel	4 047075 015146
6.062.14	Kirschner wire with trocar point on both sides, Ø 1.4 mm x 280 mm, stainless steel	4 047075 015153
6.062.15	Kirschner wire with trocar point on both sides, Ø 1.5 mm x 280 mm, stainless steel	4 047075 015160
6.062.16	Kirschner wire with trocar point on both sides, Ø 1.6 mm x 280 mm, stainless steel	4 047075 015177
6.062.18	Kirschner wire with trocar point on both sides, Ø 1.8 mm x 280 mm, stainless steel	4 047075 014989
6.062.20	Kirschner wire with trocar point on both sides, Ø 2.0 mm x 280 mm, stainless steel	4 047075 014996
6.062.22	Kirschner wire with trocar point on both sides, Ø 2.2 mm x 280 mm, stainless steel	4 047075 015122
6.062.25	Kirschner wire with trocar point on both sides, Ø 2.5 mm x 280 mm, stainless steel	4 047075 015139
6.062.30	Kirschner wire with trocar point on both sides, Ø 3.0 mm x 280 mm, stainless steel	4 047075 015214

Kirschner wire with trocar point on both sides; 310 mm length

6.052.08	Kirschner wire with trocar point on both sides, Ø 0.8 mm x 310 mm, stainless steel	4 047075 014606
6.052.10	Kirschner wire with trocar point on both sides, Ø 1.0 mm x 310 mm, stainless steel	4 047075 014613
6.052.12	Kirschner wire with trocar point on both sides, Ø 1.2 mm x 310 mm, stainless steel	4 047075 014446
6.052.14	Kirschner wire with trocar point on both sides, Ø 1.4 mm x 310 mm, stainless steel	4 047075 014453
6.052.15	Kirschner wire with trocar point on both sides, Ø 1.5 mm x 310 mm, stainless steel	4 047075 014583
6.052.16	Kirschner wire with trocar point on both sides, Ø 1.6 mm x 310 mm, stainless steel	4 047075 014651
6.052.18	Kirschner wire with trocar point on both sides, Ø 1.8 mm x 310 mm, stainless steel	4 047075 014675
6.052.20	Kirschner wire with trocar point on both sides, Ø 2.0 mm x 310 mm, stainless steel	4 047075 014705
6.052.22	Kirschner wire with trocar point on both sides, Ø 2.2 mm x 310 mm, stainless steel	4 047075 014477
6.052.25	Kirschner wire with trocar point on both sides, Ø 2.5 mm x 310 mm, stainless steel	4 047075 014538
6.052.30	Kirschner wire with trocar point on both sides, Ø 3.0 mm x 310 mm, stainless steel	4 047075 014767

Kirschner wire

stainless steel



Item no. 6.033.20 Kirschner wire with trocar point and flat end

Item no.	Item description	EAN
Kirschner wire with trocar point and flat end		
Kirschner wire with trocar point and flat end; 70 mm length		
6.013.12	Kirschner wire with trocar point and flat end, Ø 1.2 mm x 70 mm, stainless steel	4 047075 012213
6.013.14	Kirschner wire with trocar point and flat end, Ø 1.4 mm x 70 mm, stainless steel	4 047075 012220
6.013.16	Kirschner wire with trocar point and flat end, Ø 1.6 mm x 70 mm, stainless steel	4 047075 012039
Kirschner wire with trocar point and flat end; 150 mm length		
6.033.14	Kirschner wire with trocar point and flat end, Ø 1.4 mm x 150 mm, stainless steel	4 047075 013425
6.033.15	Kirschner wire with trocar point and flat end, Ø 1.5 mm x 150 mm, stainless steel	4 047075 013432
6.033.18	Kirschner wire with trocar point and flat end, Ø 1.8 mm x 150 mm, stainless steel	4 047075 013296
6.033.20	Kirschner wire with trocar point and flat end, Ø 2.0 mm x 150 mm, stainless steel	4 047075 013401
6.033.25	Kirschner wire with trocar point and flat end, Ø 2.5 mm x 150 mm, stainless steel	4 047075 013470
Kirschner wire with trocar point and flat end; 280 mm length		
6.063.15	Kirschner wire with trocar point and flat end, Ø 1.5 mm x 280 mm, stainless steel	4 047075 015252
6.063.16	Kirschner wire with trocar point and flat end, Ø 1.6 mm x 280 mm, stainless steel	4 047075 015269
6.063.18	Kirschner wire with trocar point and flat end, Ø 1.8 mm x 280 mm, stainless steel	4 047075 015016
6.063.25	Kirschner wire with trocar point and flat end, Ø 2.5 mm x 280 mm, stainless steel	4 047075 015290
6.063.30	Kirschner wire with trocar point and flat end, Ø 3.0 mm x 280 mm, stainless steel	4 047075 015306
Kirschner wire with trocar point and flat end; 310 mm length		
6.053.16	Kirschner wire with trocar point and flat end, Ø 1.6 mm x 310 mm, stainless steel	4 047075 014620
6.053.20	Kirschner wire with trocar point and flat end, Ø 2.0 mm x 310 mm, stainless steel	4 047075 014798
6.053.30	Kirschner wire with trocar point and flat end, Ø 3.0 mm x 310 mm, stainless steel	4 047075 014873

Kirschner wire

stainless steel



Item no. 6.034.20 Kirschner wire with lancet point and round end











Item no.	Item description	EAN
Kirschner wire with lancet point and round end		
Kirschner wire with lancet point and round end; 70 mm length		
6.014.08	Kirschner wire with lancet point and round end, Ø 0.8 mm x 70 mm, stainless steel	4 047075 012312
6.014.10	Kirschner wire with lancet point and round end, Ø 1.0 mm x 70 mm, stainless steel	4 047075 012329
6.014.12	Kirschner wire with lancet point and round end, Ø 1.2 mm x 70 mm, stainless steel	4 047075 012336
Kirschner wire with lancet point and round end; 120 mm length		
6.024.12	Kirschner wire with lancet point and round end, Ø 1.2 mm x 120 mm, stainless steel	4 047075 012848
6.024.14	Kirschner wire with lancet point and round end, Ø 1.4 mm x 120 mm, stainless steel	4 047075 012695
6.024.16	Kirschner wire with lancet point and round end, Ø 1.6 mm x 120 mm, stainless steel	4 047075 012763
Kirschner wire with lancet point and round end; 150 mm length		
6.034.08	Kirschner wire with lancet point and round end, Ø 0.8 mm x 150 mm, stainless steel	4 047075 013494
6.034.10	Kirschner wire with lancet point and round end, Ø 1.0 mm x 150 mm, stainless steel	4 047075 013500
6.034.12	Kirschner wire with lancet point and round end, Ø 1.2 mm x 150 mm, stainless steel	4 047075 013302
6.034.14	Kirschner wire with lancet point and round end, Ø 1.4 mm x 150 mm, stainless steel	4 047075 013364
6.034.15	Kirschner wire with lancet point and round end, Ø 1.5 mm x 150 mm, stainless steel	4 047075 013548
6.034.16	Kirschner wire with lancet point and round end, Ø 1.6 mm x 150 mm, stainless steel	4 047075 013555
6.034.18	Kirschner wire with lancet point and round end, Ø 1.8 mm x 150 mm, stainless steel	4 047075 013562
6.034.20	Kirschner wire with lancet point and round end, Ø 2.0 mm x 150 mm, stainless steel	4 047075 013357
6.034.22	Kirschner wire with lancet point and round end, Ø 2.2 mm x 150 mm, stainless steel	4 047075 013593
6.034.25	Kirschner wire with lancet point and round end, Ø 2.5 mm x 150 mm, stainless steel	4 047075 013609
6.034.30	Kirschner wire with lancet point and round end, Ø 3.0 mm x 150 mm, stainless steel	4 047075 013449

Kirschner wire

stainless steel

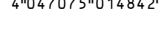

Item no. 6.034.20 Kirschner wire with lancet point and round end

Item no.	Item description	EAN
Kirschner wire with lancet point and round end; 220 mm length		
6.044.20	Kirschner wire with lancet point and round end, Ø 2.0 mm x 220 mm, stainless steel	 4 047075 014170
Kirschner wire with lancet point and round end; 280 mm length		
6.064.15	Kirschner wire with lancet point and round end, Ø 1.5 mm x 280 mm, stainless steel	 4 047075 015313
6.064.18	Kirschner wire with lancet point and round end, Ø 1.8 mm x 280 mm, stainless steel	 4 047075 015085
6.064.20	Kirschner wire with lancet point and round end, Ø 2.0 mm x 280 mm, stainless steel	 4 047075 015337
6.064.30	Kirschner wire with lancet point and round end, Ø 3.0 mm x 280 mm, stainless steel	 4 047075 015184
Kirschner wire with lancet point and round end; 300 mm length		
6.054.20/300	Kirschner wire with lancet point and round end, Ø 2.0 mm x 300 mm, stainless steel	 4 047075 013494
Kirschner wire with lancet point and round end; 310 mm length		
6.054.14	Kirschner wire with lancet point and round end, Ø 1.4 mm x 310 mm, stainless steel	 4 047075 014750
6.054.15	Kirschner wire with lancet point and round end, Ø 1.5 mm x 310 mm, stainless steel	 4 047075 014927
6.054.18	Kirschner wire with lancet point and round end, Ø 1.8 mm x 310 mm, stainless steel	 4 047075 014941
6.054.20	Kirschner wire with lancet point and round end, Ø 2.0 mm x 310 mm, stainless steel	 4 047075 014736
6.054.25	Kirschner wire with lancet point and round end, Ø 2.5 mm x 310 mm, stainless steel	 4 047075 014835
6.054.30	Kirschner wire with lancet point and round end, Ø 3.0 mm x 310 mm, stainless steel	 4 047075 014842

Cerclage wire

titanium



Item no. 7.410.12

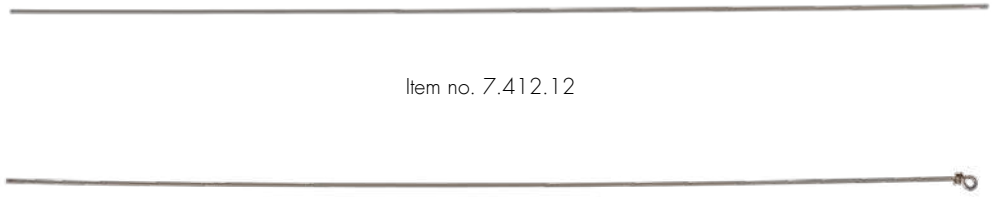

Item no. 7.412.12

Item no. 7.415.12

Item no.	Item description	EAN
Cerclage wire in ring		
7.410.08	cerclage wire in ring, Ø 0.8 mm x 10 m, titanium	4047075047208
7.410.08/5	cerclage wire in ring, Ø 0.8 mm x 5 m, titanium	4047075047215
7.410.10	cerclage wire in ring, Ø 1.0 mm x 10 m, titanium	4047075047222
7.410.10/5	cerclage wire in ring, Ø 1.0 mm x 5 m, titanium	4047075047239
7.410.12	cerclage wire in ring, Ø 1.2 mm x 10 m, titanium	4047075047246
Cerclage wire		
7.412.08	cerclage wire, Ø 0.8 mm x 200 mm, titanium	4047075046904
7.412.10	cerclage wire, Ø 1.0 mm x 250 mm, titanium	4047075047017
7.412.12	cerclage wire, Ø 1.2 mm x 300 mm, titanium	4047075046966
Cerclage wire with ear		
7.415.08	cerclage wire with ear, Ø 0.8 x 280 mm, titanium	4047075046829
7.415.086	cerclage wire with ear, Ø 0.8 x 600 mm, titanium	4047075046836
7.415.10	cerclage wire with ear, Ø 1.0 mm x 280 mm, titanium	4047075046843
7.415.106	cerclage wire with ear, Ø 1.0 mm x 600 mm, titanium	4047075046850
7.415.12	cerclage wire with ear, Ø 1.2 mm x 280 mm, titanium	4047075046928
7.415.126	cerclage wire with ear, Ø 1.2 mm x 600 mm, titanium	4047075046935

Cerclage wire

stainless steel



Item no. 6.410.12



Item no. 6.412.12





















Item no.	Item description	EAN
cerclage wire in ring		
6.410.03	cerclage wire in ring; Ø 0,3 mm x 10 m; stainless steel	4047075022670
6.410.04	cerclage wire in ring; Ø 0,4 mm x 10 m; stainless steel	4047075022472
6.410.05	cerclage wire in ring; Ø 0,5 mm x 10 m; stainless steel	4047075022700
6.410.06	cerclage wire in ring; Ø 0,6 mm x 10 m; stainless steel	4047075022717
6.410.07	cerclage wire in ring; Ø 0,7 mm x 10 m; stainless steel	4047075022564
6.410.08	cerclage wire in ring; Ø 0,8 mm x 10 m; stainless steel	4047075022571
6.410.09	cerclage wire in ring; Ø 0,9 mm x 10 m; stainless steel	4047075022687
6.410.10	cerclage wire in ring; Ø 1,0 mm x 10 m; stainless steel	4047075022694
6.410.12	cerclage wire in ring; Ø 1,2 mm x 10 m; stainless steel	4047075022762
6.410.15	cerclage wire in ring; Ø 1,5 mm x 5 m; stainless steel	4047075022779
cerclage wire		
6.412.04	cerclage wire; Ø 0,4 mm x 150 mm; stainless steel	4047075022786
6.412.06	cerclage wire; Ø 0,6 mm x 175 mm; stainless steel	4047075022793
6.412.08	cerclage wire; Ø 0,8 mm x 200 mm; stainless steel	4047075022588
6.412.09	cerclage wire; Ø 0,9 mm x 200 mm; stainless steel	4047075022649
6.412.10	cerclage wire; Ø 1,0 mm x 250 mm; stainless steel	4047075022816
6.412.10/600	cerclage wire; Ø 1,0 mm x 600 mm; stainless steel	4047075022823
6.412.12	cerclage wire; Ø 1,2 mm x 300 mm; stainless steel	4047075022830
6.412.15	cerclage wire; Ø 1,5 mm x 300 mm; stainless steel	4047075022632

Cerclage wire

stainless steel



Item no. 6.415.12

Item no.	Item description	EAN
cerclage wire with ear		
6.415.04	cerclage wire with ear; Ø 0,4 mm x 280 mm; stainless steel	 4047075022878
6.415.05	cerclage wire with ear; Ø 0,5 mm x 280 mm; stainless steel	 4047075022885
6.415.06	cerclage wire with ear; Ø 0,6 mm x 280 mm; stainless steel	 4047075022892
6.415.07	cerclage wire with ear; Ø 0,7 mm x 280 mm; stainless steel	 4047075022724
6.415.08	cerclage wire with ear; Ø 0,8 mm x 280 mm; stainless steel	 4047075022731
6.415.08/500	cerclage wire with ear; Ø 0,8 mm x 500 mm; stainless steel	 4047075022939
6.415.09	cerclage wire with ear; Ø 0,9 mm x 280 mm; stainless steel	 4047075022847
6.415.10	cerclage wire with ear; Ø 1,0 mm x 280 mm; stainless steel	 4047075022854
6.415.104	cerclage wire with ear; Ø 1,0 mm x 400 mm; stainless steel	 4047075022861
6.415.106	cerclage wire with ear; Ø 1,0 mm x 600 mm; stainless steel	 4047075022933
6.415.107	cerclage wire with ear; Ø 1,0 mm x 700 mm; stainless steel	 4047075022960
6.415.12	cerclage wire with ear; Ø 1,2 mm x 280 mm; stainless steel	 4047075022977
6.415.123	cerclage wire with ear; Ø 1,2 mm x 300 mm; stainless steel	 4047075022748
6.415.124	cerclage wire with ear; Ø 1,2 mm x 400 mm; stainless steel	 4047075022755
6.415.126	cerclage wire with ear; Ø 1,2 mm x 600 mm; stainless steel	 4047075023028
6.415.127	cerclage wire with ear; Ø 1,2 mm x 700 mm; stainless steel	 4047075023035
6.415.15	cerclage wire with ear; Ø 1,5 mm x 280 mm; stainless steel	 4047075023042
6.415.153	cerclage wire with ear; Ø 1,5 mm x 300 mm; stainless steel	 4047075114368
6.415.154	cerclage wire with ear; Ø 1,5 mm x 400 mm; stainless steel	 4047075122264
6.415.156	cerclage wire with ear; Ø 1,5 mm x 600 mm; stainless steel	 4047075023059

CANNULATED

Königsee Implantate



Your Partner in Osteosynthesis

TIS™ Screws

TiOB; titanium



Item no. 3.530.90



Item no. 3.531.90

Item no.	Item description	EAN
TIS Screws with full thread, self-tapping, self-drilling		
3.530.50	TIS screw Ø7.5mm; IØ2.9; fully threaded; s.d.; s.t.; length 50mm	4 047075 170821
3.530.55	TIS screw Ø7.5mm; IØ2.9; fully threaded; s.d.; s.t.; length 55mm	4 047075 171002
3.530.60	TIS screw Ø7.5mm; IØ2.9; fully threaded; s.d.; s.t.; length 60mm	4 047075 171019
3.530.65	TIS screw Ø7.5mm; IØ2.9; fully threaded; s.d.; s.t.; length 65mm	4 047075 171026
3.530.70	TIS screw Ø7.5mm; IØ2.9; fully threaded; s.d.; s.t.; length 70mm	4 047075 168569
3.530.75	TIS screw Ø7.5mm; IØ2.9; fully threaded; s.d.; s.t.; length 75mm	4 047075 168576
3.530.80	TIS screw Ø7.5mm; IØ2.9; fully threaded; s.d.; s.t.; length 80mm	4 047075 168583
3.530.85	TIS screw Ø7.5mm; IØ2.9; fully threaded; s.d.; s.t.; length 85mm	4 047075 168590
3.530.90	TIS screw Ø7.5mm; IØ2.9; fully threaded; s.d.; s.t.; length 90mm	4 047075 168606
3.530.95	TIS screw Ø7.5mm; IØ2.9; fully threaded; s.d.; s.t.; length 95mm	4 047075 168613
3.530.100	TIS screw Ø7.5mm; IØ2.9; fully threaded; s.d.; s.t.; length 100mm	4 047075 168521
3.530.105	TIS screw Ø7.5mm; IØ2.9; fully threaded; s.d.; s.t.; length 105mm	4 047075 168538
3.530.110	TIS screw Ø7.5mm; IØ2.9; fully threaded; s.d.; s.t.; length 110mm	4 047075 168545
3.530.115	TIS screw Ø7.5mm; IØ2.9; fully threaded; s.d.; s.t.; length 115mm	4 047075 168552
3.530.120	TIS screw Ø7.5mm; IØ2.9; fully threaded; s.d.; s.t.; length 120mm	4 047075 170913
3.530.125	TIS screw Ø7.5mm; IØ2.9; fully threaded; s.d.; s.t.; length 125mm	4 047075 170920
3.530.130	TIS screw Ø7.5mm; IØ2.9; fully threaded; s.d.; s.t.; length 130mm	4 047075 170937
3.530.135	TIS screw Ø7.5mm; IØ2.9; fully threaded; s.d.; s.t.; length 135mm	4 047075 170944
3.530.140	TIS screw Ø7.5mm; IØ2.9; fully threaded; s.d.; s.t.; length 140mm	4 047075 170951
3.530.145	TIS screw Ø7.5mm; IØ2.9; fully threaded; s.d.; s.t.; length 145mm	4 047075 170968
3.530.150	TIS screw Ø7.5mm; IØ2.9; fully threaded; s.d.; s.t.; length 150mm	4 047075 170975
3.530.155	TIS screw Ø7.5mm; IØ2.9; fully threaded; s.d.; s.t.; length 155mm	4 047075 170982
3.530.160	TIS screw Ø7.5mm; IØ2.9; fully threaded; s.d.; s.t.; length 160mm	4 047075 170999
3.530.165	TIS screw Ø7.5mm; IØ2.9; fully threaded; s.d.; s.t.; length 165mm	4 047075 170814

TIS™ Screws

TiOB; titanium



Item no. 3.530.90



Item no. 3.531.90

Item no.	Item description	EAN
TIS Screws with partial thread 32mm, self-drilling, self-tapping, back-tapping		
3.531.50	TIS screw Ø7.5mm; lØ2.9; s.d.; s.t.; b.t.; length 50/32mm	4 047075 170845
3.531.55	TIS screw Ø7.5mm; lØ2.9; s.d.; s.t.; b.t.; length 55/32mm	4 047075 171064
3.531.60	TIS screw Ø7.5mm; lØ2.9; s.d.; s.t.; b.t.; length 60/32mm	4 047075 171071
3.531.65	TIS screw Ø7.5mm; lØ2.9; s.d.; s.t.; b.t.; length 65/32mm	4 047075 171088
3.531.70	TIS screw Ø7.5mm; lØ2.9; s.d.; s.t.; b.t.; length 70/32mm	4 047075 168668
3.531.75	TIS screw Ø7.5mm; lØ2.9; s.d.; s.t.; b.t.; length 75/32mm	4 047075 168675
3.531.80	TIS screw Ø7.5mm; lØ2.9; s.d.; s.t.; b.t.; length 80/32mm	4 047075 168682
3.531.85	TIS screw Ø7.5mm; lØ2.9; s.d.; s.t.; b.t.; length 85/32mm	4 047075 168699
3.531.90	TIS screw Ø7.5mm; lØ2.9; s.d.; s.t.; b.t.; length 90/32mm	4 047075 168705
3.531.95	TIS screw Ø7.5mm; lØ2.9; s.d.; s.t.; b.t.; length 95/32mm	4 047075 168712
3.531.100	TIS screw Ø7.5mm; lØ2.9; s.d.; s.t.; b.t.; length 100/32mm	4 047075 168620
3.531.105	TIS screw Ø7.5mm; lØ2.9; s.d.; s.t.; b.t.; length 105/32mm	4 047075 168637
3.531.110	TIS screw Ø7.5mm; lØ2.9; s.d.; s.t.; b.t.; length 110/32mm	4 047075 168644
3.531.115	TIS screw Ø7.5mm; lØ2.9; s.d.; s.t.; b.t.; length 115/32mm	4 047075 168651
3.531.120	TIS screw Ø7.5mm; lØ2.9; s.d.; s.t.; b.t.; length 120/32mm	4 047075 171033
3.531.125	TIS screw Ø7.5mm; lØ2.9; s.d.; s.t.; b.t.; length 125/32mm	4 047075 171040
3.531.130	TIS screw Ø7.5mm; lØ2.9; s.d.; s.t.; b.t.; length 130/32mm	4 047075 171057
3.531.135	TIS screw Ø7.5mm; lØ2.9; s.d.; s.t.; b.t.; length 135/32mm	4 047075 170838

Information:

The name TIS™ derives from the German designation "Transiliosakralschraube", which translates into English as "transiliosacral screw". Products with the add-on "™" are trademarks of Königsee Implantate.

TiOB® is a trademark of Königsee Implantate GmbH registered in the EU countries, Switzerland and the USA. It is a surface treatment that brings optimized properties.

Set TIS™ Screws

with instruments; TiOB; titanium; Set no. 19.681.00



Item no. 3.531.90



Item no. 3.530.90

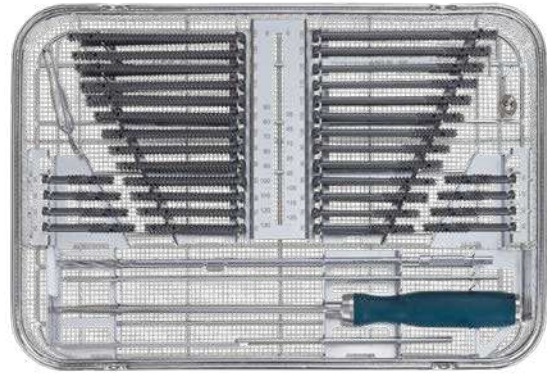

Set no. 19.681.00  Internal hexagon

Item no.	Item description	Quant.
Implants - screws		
TIS™ Screws; full thread; Ø 7.5 mm, inner Ø 2.9 mm; self-drilling; self-tapping; titanium		
3.530.50	Length 50 mm	2
3.530.55	Length 55 mm	2
3.530.60	Length 60 mm	2
3.530.65	Length 65 mm	2
3.530.70	Length 70 mm	2
3.530.75	Length 75 mm	2
3.530.80	Length 80 mm	2
3.530.85	Length 85 mm	2
3.530.90	Length 90 mm	2
3.530.95	Length 95 mm	2
3.530.100	Length 100 mm	2
3.530.105	Length 105 mm	2
3.530.110	Length 110 mm	2
3.530.115	Length 115 mm	2
3.530.120	Length 120 mm	2
3.530.125	Length 125 mm	2
3.530.130	Length 130 mm	2

Instruments		
2.908.50	drill bit w.coupling, Ø5x300, spiral length 55, cannulated Ø2.9, four-spiral	1
2.9435.75	hex screwdriver with handle for Ø7.5, cannulated, IØ2.9, wrench size 4, L 324mm	1
2.952.140	gauge for cannulated screws Ø7.5, measuring range 140, length 275mm	1
2.954.01	screw forceps, self holding	1

Item no.	Item description	Quant.
Implants - screws		
TIS™ Screws; thread 32mm; Ø 7.5 mm, inner Ø 2.9 mm; self-drilling; self-tapping; back-tapping; titanium		
3.531.50	Length 50 mm	2
3.531.55	Length 55 mm	2
3.531.60	Length 60 mm	2
3.531.65	Length 65 mm	2
3.531.70	Length 70 mm	2
3.531.75	Length 75 mm	2
3.531.80	Length 80 mm	2
3.531.85	Length 85 mm	2
3.531.90	Length 90 mm	2
3.531.95	Length 95 mm	2
3.531.100	Length 100 mm	2
3.531.105	Length 105 mm	2
3.531.110	Length 110 mm	2
3.531.115	Length 115 mm	2
3.531.120	Length 120 mm	2
3.531.125	Length 125 mm	2
3.531.130	Length 130 mm	2

Implants – washer		
3.200.04	washer, outside Ø16 / inside Ø6.7, ti	5

Wires		
2.980.28	guide wire, Ø2.8x300, thread 5, st. st.	5



Königsee Implantate GmbH
OT Aschau | Am Sand 4
07426 Allendorf | Germany

Fon +49 36738 498-560
Fax +49 36738 498-569

Mail export@koenigsee-implantate.de

For further information please visit:
www.koenigsee-implantate.com

AnSp | Edition 03 | 2020-03
All pictured products are CE compliant.

Set TIS™ Screws

with instruments; TiOB; titanium; Set no. 19.681.00

Container

19.680.00

perforated autoclavable container
w.inset f.instr.a.TIS-screws Ø7,5

1

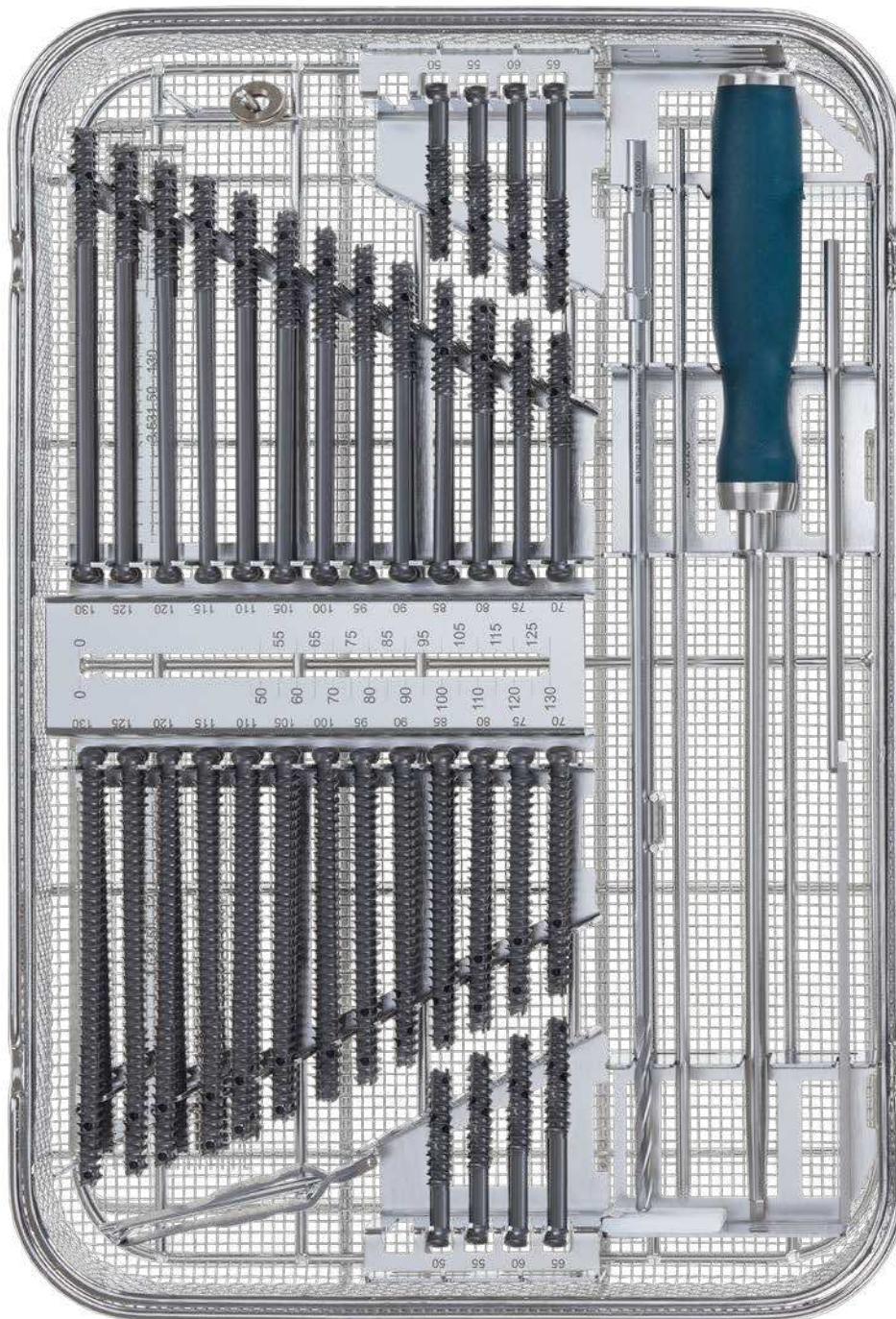

Set no. 19.681.00

Cannulated

Information:

The name TIS™ derives from the German designation "Transiliosakralschraube", which translates into English as "transiliosacral screw". Products with the add-on "™" are trademarks of Königsee Implantate.

TiOB® is a trademark of Königsee Implantate GmbH registered in the EU countries, Switzerland and the USA. It is a surface treatment that brings optimized properties.



Königsee Implantate GmbH
OT Aschau | Am Sand 4
07426 Allendorf | Germany

Fon +49 36738 498-560
Fax +49 36738 498-569

Mail export@koenigsee-implantate.de

For further information please visit:
www.koenigsee-implantate.com

AnSp | Edition 03 | 2020-03
All pictured products are CE compliant.

Upgrade Set for TIS™-Screws

with Instruments; TiOB; Titanium; Set no. 19.681.00/1

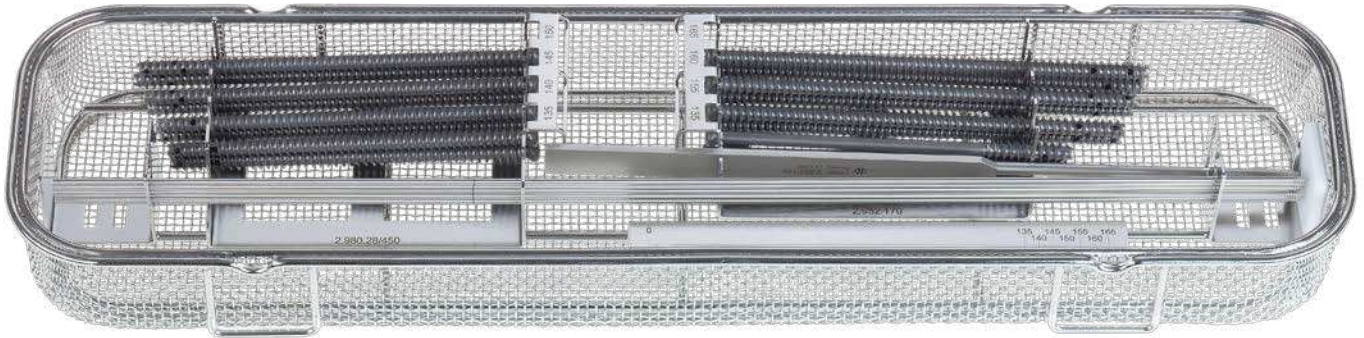

Set no. 19.681.00/1

Item no.	Item description	Quant.
TIS™-screws; fully threaded		
Ø 7.5 mm, inside Ø 2.9 mm; self drilling; self tapping; cannulated; titanium		
3.530.135	length 135 mm	2
3.530.140	length 140 mm	2
3.530.145	length 145 mm	2
3.530.150	length 150 mm	2
3.530.155	length 155 mm	2
3.530.160	length 160 mm	2
3.530.165	length 165 mm	2

Item no.	Item description	Quant.
TIS™-screws; thread 32 mm		
Ø 7.5 mm, inside Ø 2.9 mm; self drilling; self tapping; back tapping; cannulated; titanium		
3.531.135	length 135 mm	2

Item no.	Item description	Quant.
Container		
19.680.00/1	perforated autoclavable container with inset for instruments and implants for upgrade-set TIS™-screws	1

Item no.	Item description	Quant.
Further instruments		
2.952.170	gauge for cannulated screws Ø 7.5 mm; measuring range 170 mm; length 275 mm	1
2.980.28/450	guide wire; Ø 2.8 x 450 mm; thread 5 mm; stainless steel	5

Information:

The name TIS™ derives from the German designation "Transiliosakralschraube", which translates into English as "transiliosacral screw". Products with the add-on "™" are trademarks of Königsee Implantate.

TiOB® is a trademark of Königsee Implantate GmbH registered in the EU countries, Switzerland and the USA. It is a surface treatment that brings optimized properties.

Cannulated screws

titanium



Item no. 3.448.30



Item no. 3.450.30



Item no. 3.504.30



Item no. 3.602.30



Item no. 3.440.30



Item no. 3.445.30



Item no. 3.434.30



Item no. 3.435.30

Item no.	Item description	EAN
----------	------------------	-----

Cannulated screw 2.7 partial thread st sd – TiOB®

3.448.10	Ø 2.7 x 10 mm; thread 5; self drilling; self tapping; titanium	4 047075 098422
3.448.12	Ø 2.7 x 12 mm; thread 5; self drilling; self tapping; titanium	4 047075 098439
3.448.14	Ø 2.7 x 14 mm; thread 5; self drilling; self tapping; titanium	4 047075 098330
3.448.16	Ø 2.7 x 16 mm; thread 6; self drilling; self tapping; titanium	4 047075 098453
3.448.18	Ø 2.7 x 18 mm; thread 7; self drilling; self tapping; titanium	4 047075 098347
3.448.20	Ø 2.7 x 20 mm; thread 8; self drilling; self tapping; titanium	4 047075 098354
3.448.22	Ø 2.7 x 22 mm; thread 9; self drilling; self tapping; titanium	4 047075 098361
3.448.24	Ø 2.7 x 24 mm; thread 10; self drilling; self tapping; titanium	4 047075 098446
3.448.26	Ø 2.7 x 26 mm; thread 10; self drilling; self tapping; titanium	4 047075 098545
3.448.28	Ø 2.7 x 28 mm; thread 12; self drilling; self tapping; titanium	4 047075 098460
3.448.30	Ø 2.7 x 30 mm; thread 12; self drilling; self tapping; titanium	4 047075 098477
3.448.32	Ø 2.7 x 32 mm; thread 12; self drilling; self tapping; titanium	4 047075 098484
3.448.34	Ø 2.7 x 34 mm; thread 12; self drilling; self tapping; titanium	4 047075 098378
3.448.35	Ø 2.7 x 35 mm; thread 15; self drilling; self tapping; titanium	4 047075 098385
3.448.36	Ø 2.7 x 36 mm; thread 15; self drilling; self tapping; titanium	4 047075 098408
3.448.38	Ø 2.7 x 38 mm; thread 15; self drilling; self tapping; titanium	4 047075 098552
3.448.40	Ø 2.7 x 40 mm; thread 15; self drilling; self tapping; titanium	4 047075 098569
3.448.42	Ø 2.7 x 42 mm; thread 15; self drilling; self tapping; titanium	4 047075 098576
3.448.44	Ø 2.7 x 44 mm; thread 15; self drilling; self tapping; titanium	4 047075 098491
3.448.45	Ø 2.7 x 45 mm; thread 15; self drilling; self tapping; titanium	4 047075 098590
3.448.46	Ø 2.7 x 46 mm; thread 15; self drilling; self tapping; titanium	4 047075 098507
3.448.48	Ø 2.7 x 48 mm; thread 15; self drilling; self tapping; titanium	4 047075 098514
3.448.50	Ø 2.7 x 50 mm; thread 15; self drilling; self tapping; titanium	4 047075 098521
3.448.55	Ø 2.7 x 55 mm; thread 20; self drilling; self tapping; titanium	4 047075 098583
3.448.60	Ø 2.7 x 60 mm; thread 20; self drilling; self tapping; titanium	4 047075 098699
3.448.65	Ø 2.7 x 65 mm; thread 20; self drilling; self tapping; titanium	4 047075 059126

Cannulated screws

titanium



Item no. 3.520.70



Item no. 3.523.70



Item no. 3.525.70



Item no. 3.414.70



Item no. 3.424.70













Item no. 3.427.70

Item no.	Item description	EAN
3.448.70	Ø 2.7 x 70 mm; thread 20; self drilling; self tapping; titanium	
3.448.75	Ø 2.7 x 75 mm; thread 20; self drilling; self tapping; titanium	
3.448.80	Ø 2.7 x 80 mm; thread 20; self drilling; self tapping; titanium	
Cannulated screw 2.7 st sd – TiOB®		
3.450.06	Ø 2.7 x 6 mm; fully threaded; self drilling; self tapping; titanium	
3.450.08	Ø 2.7 x 8 mm; fully threaded; self drilling; self tapping; titanium	
3.450.10	Ø 2.7 x 10 mm; fully threaded; self drilling; self tapping; titanium	
3.450.12	Ø 2.7 x 12 mm; fully threaded; self drilling; self tapping; titanium	
3.450.14	Ø 2.7 x 14 mm; fully threaded; self drilling; self tapping; titanium	
3.450.16	Ø 2.7 x 16 mm; fully threaded; self drilling; self tapping; titanium	
3.450.18	Ø 2.7 x 18 mm; fully threaded; self drilling; self tapping; titanium	
3.450.20	Ø 2.7 x 20 mm; fully threaded; self drilling; self tapping; titanium	
3.450.22	Ø 2.7 x 22 mm; fully threaded; self drilling; self tapping; titanium	
3.450.24	Ø 2.7 x 24 mm; fully threaded; self drilling; self tapping; titanium	
3.450.26	Ø 2.7 x 26 mm; fully threaded; self drilling; self tapping; titanium	
3.450.28	Ø 2.7 x 28 mm; fully threaded; self drilling; self tapping; titanium	
3.450.30	Ø 2.7 x 30 mm; fully threaded; self drilling; self tapping; titanium	
3.450.32	Ø 2.7 x 32 mm; fully threaded; self drilling; self tapping; titanium	
3.450.34	Ø 2.7 x 34 mm; fully threaded; self drilling; self tapping; titanium	
3.450.35	Ø 2.7 x 35 mm; fully threaded; self drilling; self tapping; titanium	
3.450.36	Ø 2.7 x 36 mm; fully threaded; self drilling; self tapping; titanium	
3.450.38	Ø 2.7 x 38 mm; fully threaded; self drilling; self tapping; titanium	
3.450.40	Ø 2.7 x 40 mm; fully threaded; self drilling; self tapping; titanium	
3.450.42	Ø 2.7 x 42 mm; fully threaded; self drilling; self tapping; titanium	
3.450.44	Ø 2.7 x 44 mm; fully threaded; self drilling; self tapping; titanium	
3.450.45	Ø 2.7 x 45 mm; fully threaded; self drilling; self tapping; titanium	
3.450.46	Ø 2.7 x 46 mm; fully threaded; self drilling; self tapping; titanium	

Cannulated screws

titanium

Item no.	Item description	EAN
3.450.48	Ø 2.7 x 48 mm; fully threaded; self drilling; self tapping; titanium	
3.450.50	Ø 2.7 x 50 mm; fully threaded; self drilling; self tapping; titanium	
3.450.55	Ø 2.7 x 55 mm; fully threaded; self drilling; self tapping; titanium	
3.450.60	Ø 2.7 x 60 mm; fully threaded; self drilling; self tapping; titanium	
3.450.65	Ø 2.7 x 65 mm; fully threaded; self drilling; self tapping; titanium	
3.450.70	Ø 2.7 x 70 mm; fully threaded; self drilling; self tapping; titanium	
3.450.75	Ø 2.7 x 75 mm; fully threaded; self drilling; self tapping; titanium	
3.450.80	Ø 2.7 x 80 mm; fully threaded; self drilling; self tapping; titanium	
Cannulated screw 3.5 partial thread st		
3.502.10	Ø 3.5 x 10 mm; thread 5; self tapping; titanium	
3.502.12	Ø 3.5 x 12 mm; thread 5; self tapping; titanium	
3.502.14	Ø 3.5 x 14 mm; thread 5; self tapping; titanium	
3.502.16	Ø 3.5 x 16 mm; thread 6; self tapping; titanium	
3.502.18	Ø 3.5 x 18 mm; thread 7; self tapping; titanium	
3.502.20	Ø 3.5 x 20 mm; thread 8; self tapping; titanium	
3.502.22	Ø 3.5 x 22 mm; thread 9; self tapping; titanium	
3.502.24	Ø 3.5 x 24 mm; thread 10; self tapping; titanium	
3.502.26	Ø 3.5 x 26 mm; thread 12; self tapping; titanium	
3.502.28	Ø 3.5 x 28 mm; thread 14; self tapping; titanium	
3.502.30	Ø 3.5 x 30 mm; thread 14; self tapping; titanium	
3.502.32	Ø 3.5 x 32 mm; thread 14; self tapping; titanium	
3.502.34	Ø 3.5 x 34 mm; thread 14; self tapping; titanium	
3.502.36	Ø 3.5 x 36 mm; thread 14; self tapping; titanium	
3.502.38	Ø 3.5 x 38 mm; thread 14; self tapping; titanium	
3.502.40	Ø 3.5 x 40 mm; thread 14; self tapping; titanium	
3.502.42	Ø 3.5 x 42 mm; thread 15; self tapping; titanium	
3.502.44	Ø 3.5 x 44 mm; thread 15; self tapping; titanium	
3.502.46	Ø 3.5 x 46 mm; thread 15; self tapping; titanium	
3.502.48	Ø 3.5 x 48 mm; thread 15; self tapping; titanium	
3.502.50	Ø 3.5 x 50 mm; thread 15; self tapping; titanium	
3.502.52	Ø 3.5 x 52 mm; thread 16; self tapping; titanium	
3.502.54	Ø 3.5 x 54 mm; thread 16; self tapping; titanium	
3.502.56	Ø 3.5 x 56 mm; thread 16; self tapping; titanium	
3.502.58	Ø 3.5 x 58 mm; thread 16; self tapping; titanium	

Cannulated screws

titanium

Item no.	Item description	EAN
3.502.60	Ø 3.5 x 60 mm; thread 16; self tapping; titanium	
3.502.62	Ø 3.5 x 62 mm; thread 17; self tapping; titanium	
3.502.64	Ø 3.5 x 64 mm; thread 17; self tapping; titanium	
3.502.66	Ø 3.5 x 66 mm; thread 17; self tapping; titanium	
3.502.68	Ø 3.5 x 68 mm; thread 17; self tapping; titanium	
3.502.70	Ø 3.5 x 70 mm; thread 17; self tapping; titanium	
Cannulated screw 3.5 partial thread st bt sd		
3.504.10	Ø 3.5 x 10 mm; thread 5; self drilling; back tapping; self tapping; titanium	
3.504.12	Ø 3.5 x 12 mm; thread 5; self drilling; back tapping; self tapping; titanium	
3.504.14	Ø 3.5 x 14 mm; thread 5; self drilling; back tapping; self tapping; titanium	
3.504.16	Ø 3.5 x 16 mm; thread 6; self drilling; back tapping; self tapping; titanium	
3.504.18	Ø 3.5 x 18 mm; thread 7; self drilling; back tapping; self tapping; titanium	
3.504.20	Ø 3.5 x 20 mm; thread 8; self drilling; back tapping; self tapping; titanium	
3.504.22	Ø 3.5 x 22 mm; thread 9; self drilling; back tapping; self tapping; titanium	
3.504.24	Ø 3.5 x 24 mm; thread 10; self drilling; back tapping; self tapping; titanium	
3.504.26	Ø 3.5 x 26 mm; thread 12; self drilling; back tapping; self tapping; titanium	
3.504.28	Ø 3.5 x 28 mm; thread 14; self drilling; back tapping; self tapping; titanium	
3.504.30	Ø 3.5 x 30 mm; thread 14; self drilling; back tapping; self tapping; titanium	
3.504.32	Ø 3.5 x 32 mm; thread 14; self drilling; back tapping; self tapping; titanium	
3.504.34	Ø 3.5 x 34 mm; thread 14; self drilling; back tapping; self tapping; titanium	
3.504.36	Ø 3.5 x 36 mm; thread 14; self drilling; back tapping; self tapping; titanium	
3.504.38	Ø 3.5 x 38 mm; thread 14; self drilling; back tapping; self tapping; titanium	
3.504.40	Ø 3.5 x 40 mm; thread 14; self drilling; back tapping; self tapping; titanium	
3.504.42	Ø 3.5 x 42 mm; thread 15; self drilling; back tapping; self tapping; titanium	
3.504.44	Ø 3.5 x 44 mm; thread 15; self drilling; back tapping; self tapping; titanium	
3.504.46	Ø 3.5 x 46 mm; thread 15; self drilling; back tapping; self tapping; titanium	
3.504.48	Ø 3.5 x 48 mm; thread 15; self drilling; back tapping; self tapping; titanium	
3.504.50	Ø 3.5 x 50 mm; thread 15; self drilling; back tapping; self tapping; titanium	
3.504.52	Ø 3.5 x 52 mm; thread 16; self drilling; back tapping; self tapping; titanium	
3.504.54	Ø 3.5 x 54 mm; thread 16; self drilling; back tapping; self tapping; titanium	
3.504.56	Ø 3.5 x 56 mm; thread 16; self drilling; back tapping; self tapping; titanium	
3.504.58	Ø 3.5 x 58 mm; thread 16; self drilling; back tapping; self tapping; titanium	
3.504.60	Ø 3.5 x 60 mm; thread 16; self drilling; back tapping; self tapping; titanium	
3.504.62	Ø 3.5 x 62 mm; thread 17; self drilling; back tapping; self tapping; titanium	

Cannulated screws

titanium

Item no.	Item description	EAN
3.504.64	Ø 3.5 x 64 mm; thread 17; self drilling; back tapping; self tapping; titanium	 4 047075 000784
3.504.66	Ø 3.5 x 66 mm; thread 17; self drilling; back tapping; self tapping; titanium	 4 047075 000791
3.504.68	Ø 3.5 x 68 mm; thread 17; self drilling; back tapping; self tapping; titanium	 4 047075 000807
3.504.70	Ø 3.5 x 70 mm; thread 17; self drilling; back tapping; self tapping; titanium	 4 047075 000814
Cannulated screw 3.5 st		
3.602.10	Ø 3.5 x 10 mm; fully threaded; self tapping; titanium	 4 047075 101054
3.602.12	Ø 3.5 x 12 mm; fully threaded; self tapping; titanium	 4 047075 100965
3.602.14	Ø 3.5 x 14 mm; fully threaded; self tapping; titanium	 4 047075 100972
3.602.16	Ø 3.5 x 16 mm; fully threaded; self tapping; titanium	 4 047075 100996
3.602.18	Ø 3.5 x 18 mm; fully threaded; self tapping; titanium	 4 047075 101146
3.602.20	Ø 3.5 x 20 mm; fully threaded; self tapping; titanium	 4 047075 101153
3.602.22	Ø 3.5 x 22 mm; fully threaded; self tapping; titanium	 4 047075 101160
3.602.24	Ø 3.5 x 24 mm; fully threaded; self tapping; titanium	 4 047075 101061
3.602.26	Ø 3.5 x 26 mm; fully threaded; self tapping; titanium	 4 047075 101184
3.602.28	Ø 3.5 x 28 mm; fully threaded; self tapping; titanium	 4 047075 101078
3.602.30	Ø 3.5 x 30 mm; fully threaded; self tapping; titanium	 4 047075 101085
3.602.32	Ø 3.5 x 32 mm; fully threaded; self tapping; titanium	 4 047075 101092
3.602.34	Ø 3.5 x 34 mm; fully threaded; self tapping; titanium	 4 047075 101177
3.602.36	Ø 3.5 x 36 mm; fully threaded; self tapping; titanium	 4 047075 101283
3.602.38	Ø 3.5 x 38 mm; fully threaded; self tapping; titanium	 4 047075 101191
3.602.40	Ø 3.5 x 40 mm; fully threaded; self tapping; titanium	 4 047075 101207
3.602.42	Ø 3.5 x 42 mm; fully threaded; self tapping; titanium	 4 047075 101214
3.602.44	Ø 3.5 x 44 mm; fully threaded; self tapping; titanium	 4 047075 101108
3.602.46	Ø 3.5 x 46 mm; fully threaded; self tapping; titanium	 4 047075 101115
3.602.48	Ø 3.5 x 48 mm; fully threaded; self tapping; titanium	 4 047075 101139
3.602.50	Ø 3.5 x 50 mm; fully threaded; self tapping; titanium	 4 047075 101306
3.602.52	Ø 3.5 x 52 mm; fully threaded; self tapping; titanium	 4 047075 101313
3.602.54	Ø 3.5 x 54 mm; fully threaded; self tapping; titanium	 4 047075 101320
3.602.56	Ø 3.5 x 56 mm; fully threaded; self tapping; titanium	 4 047075 101221
3.602.58	Ø 3.5 x 58 mm; fully threaded; self tapping; titanium	 4 047075 101344
3.602.60	Ø 3.5 x 60 mm; fully threaded; self tapping; titanium	 4 047075 101238
3.602.62	Ø 3.5 x 62 mm; fully threaded; self tapping; titanium	 4 047075 101245
3.602.64	Ø 3.5 x 64 mm; fully threaded; self tapping; titanium	 4 047075 101252
3.602.66	Ø 3.5 x 66 mm; fully threaded; self tapping; titanium	 4 047075 101337





Cannulated screws

titanium

Item no.	Item description	EAN
3.602.68	Ø 3.5 x 68 mm; fully threaded; self tapping; titanium	 4 047075 101443
3.602.70	Ø 3.5 x 70 mm; fully threaded; self tapping; titanium	 4 047075 101351
Cannulated screw 3.5 st sd		
3.604.10	Ø 3.5 x 10 mm; fully threaded; self drilling; self tapping; titanium	 4 047075 000821
3.604.12	Ø 3.5 x 12 mm; fully threaded; self drilling; self tapping; titanium	 4 047075 000838
3.604.14	Ø 3.5 x 14 mm; fully threaded; self drilling; self tapping; titanium	 4 047075 000845
3.604.16	Ø 3.5 x 16 mm; fully threaded; self drilling; self tapping; titanium	 4 047075 000852
3.604.18	Ø 3.5 x 18 mm; fully threaded; self drilling; self tapping; titanium	 4 047075 000869
3.604.20	Ø 3.5 x 20 mm; fully threaded; self drilling; self tapping; titanium	 4 047075 000876
3.604.22	Ø 3.5 x 22 mm; fully threaded; self drilling; self tapping; titanium	 4 047075 000883
3.604.24	Ø 3.5 x 24 mm; fully threaded; self drilling; self tapping; titanium	 4 047075 000890
3.604.26	Ø 3.5 x 26 mm; fully threaded; self drilling; self tapping; titanium	 4 047075 000906
3.604.28	Ø 3.5 x 28 mm; fully threaded; self drilling; self tapping; titanium	 4 047075 000913
3.604.30	Ø 3.5 x 30 mm; fully threaded; self drilling; self tapping; titanium	 4 047075 000920
3.604.32	Ø 3.5 x 32 mm; fully threaded; self drilling; self tapping; titanium	 4 047075 000937
3.604.34	Ø 3.5 x 34 mm; fully threaded; self drilling; self tapping; titanium	 4 047075 000944
3.604.36	Ø 3.5 x 36 mm; fully threaded; self drilling; self tapping; titanium	 4 047075 000951
3.604.38	Ø 3.5 x 38 mm; fully threaded; self drilling; self tapping; titanium	 4 047075 000968
3.604.40	Ø 3.5 x 40 mm; fully threaded; self drilling; self tapping; titanium	 4 047075 000975
3.604.42	Ø 3.5 x 42 mm; fully threaded; self drilling; self tapping; titanium	 4 047075 000982
3.604.44	Ø 3.5 x 44 mm; fully threaded; self drilling; self tapping; titanium	 4 047075 000999
3.604.46	Ø 3.5 x 46 mm; fully threaded; self drilling; self tapping; titanium	 4 047075 001002
3.604.48	Ø 3.5 x 48 mm; fully threaded; self drilling; self tapping; titanium	 4 047075 001019
3.604.50	Ø 3.5 x 50 mm; fully threaded; self drilling; self tapping; titanium	 4 047075 001026
3.604.52	Ø 3.5 x 52 mm; fully threaded; self drilling; self tapping; titanium	 4 047075 001033
3.604.54	Ø 3.5 x 54 mm; fully threaded; self drilling; self tapping; titanium	 4 047075 001040
3.604.56	Ø 3.5 x 56 mm; fully threaded; self drilling; self tapping; titanium	 4 047075 001057
3.604.58	Ø 3.5 x 58 mm; fully threaded; self drilling; self tapping; titanium	 4 047075 001064
3.604.60	Ø 3.5 x 60 mm; fully threaded; self drilling; self tapping; titanium	 4 047075 001071
3.604.62	Ø 3.5 x 62 mm; fully threaded; self drilling; self tapping; titanium	 4 047075 001088
3.604.64	Ø 3.5 x 64 mm; fully threaded; self drilling; self tapping; titanium	 4 047075 001095
3.604.66	Ø 3.5 x 66 mm; fully threaded; self drilling; self tapping; titanium	 4 047075 001101
3.604.68	Ø 3.5 x 68 mm; fully threaded; self drilling; self tapping; titanium	 4 047075 001118
3.604.70	Ø 3.5 x 70 mm; fully threaded; self drilling; self tapping; titanium	 4 047075 001125

Cannulated screws

titanium

Item no.	Item description	EAN
Cannulated screw 4.0 partial thread st bt sd – TiOB®		
3.440.10	Ø 4.0 x 10 mm; thread 5; self drilling; self tapping; back tapping; titanium	
3.440.12	Ø 4.0 x 12 mm; thread 5; self drilling; self tapping; back tapping; titanium	
3.440.14	Ø 4.0 x 14 mm; thread 5; self drilling; self tapping; back tapping; titanium	
3.440.16	Ø 4.0 x 16 mm; thread 6; self drilling; self tapping; back tapping; titanium	
3.440.18	Ø 4.0 x 18 mm; thread 7; self drilling; self tapping; back tapping; titanium	
3.440.20	Ø 4.0 x 20 mm; thread 8; self drilling; self tapping; back tapping; titanium	
3.440.22	Ø 4.0 x 22 mm; thread 9; self drilling; self tapping; back tapping; titanium	
3.440.24	Ø 4.0 x 24 mm; thread 10; self drilling; self tapping; back tapping; titanium	
3.440.26	Ø 4.0 x 26 mm; thread 12; self drilling; self tapping; back tapping; titanium	
3.440.28	Ø 4.0 x 28 mm; thread 14; self drilling; self tapping; back tapping; titanium	
3.440.30	Ø 4.0 x 30 mm; thread 14; self drilling; self tapping; back tapping; titanium	
3.440.32	Ø 4.0 x 32 mm; thread 14; self drilling; self tapping; back tapping; titanium	
3.440.34	Ø 4.0 x 34 mm; thread 14; self drilling; self tapping; back tapping; titanium	
3.440.35	Ø 4.0 x 35 mm; thread 14; self drilling; self tapping; back tapping; titanium	
3.440.36	Ø 4.0 x 36 mm; thread 14; self drilling; self tapping; back tapping; titanium	
3.440.38	Ø 4.0 x 38 mm; thread 14; self drilling; self tapping; back tapping; titanium	
3.440.40	Ø 4.0 x 40 mm; thread 14; self drilling; self tapping; back tapping; titanium	
3.440.42	Ø 4.0 x 42 mm; thread 15; self drilling; self tapping; back tapping; titanium	
3.440.44	Ø 4.0 x 44 mm; thread 15; self drilling; self tapping; back tapping; titanium	
3.440.45	Ø 4.0 x 45 mm; thread 15; self drilling; self tapping; back tapping; titanium	
3.440.46	Ø 4.0 x 46 mm; thread 15; self drilling; self tapping; back tapping; titanium	
3.440.48	Ø 4.0 x 48 mm; thread 15; self drilling; self tapping; back tapping; titanium	
3.440.50	Ø 4.0 x 50 mm; thread 15; self drilling; self tapping; back tapping; titanium	
3.440.55	Ø 4.0 x 55 mm; thread 16; self drilling; self tapping; back tapping; titanium	
3.440.60	Ø 4.0 x 60 mm; thread 16; self drilling; self tapping; back tapping; titanium	
3.440.65	Ø 4.0 x 65 mm; thread 17; self drilling; self tapping; back tapping; titanium	
3.440.70	Ø 4.0 x 70 mm; thread 17; self drilling; self tapping; back tapping; titanium	
3.440.75	Ø 4.0 x 75 mm; thread 17; self drilling; self tapping; back tapping; titanium	
3.440.80	Ø 4.0 x 80 mm; thread 18; self drilling; self tapping; back tapping; titanium	
Cannulated screw 4.0 st sd – TiOB®		
3.445.10	Ø 4.0 x 10 mm; fully threaded; self drilling; self tapping; titanium	
3.445.12	Ø 4.0 x 12 mm; fully threaded; self drilling; self tapping; titanium	
3.445.14	Ø 4.0 x 14 mm; fully threaded; self drilling; self tapping; titanium	

Cannulated screws

titanium

Item no.	Item description	EAN
3.445.16	Ø 4.0 x 16 mm; fully threaded; self drilling; self tapping; titanium	 4 047075 098125
3.445.18	Ø 4.0 x 18 mm; fully threaded; self drilling; self tapping; titanium	 4 047075 098231
3.445.20	Ø 4.0 x 20 mm; fully threaded; self drilling; self tapping; titanium	 4 047075 098149
3.445.22	Ø 4.0 x 22 mm; fully threaded; self drilling; self tapping; titanium	 4 047075 098156
3.445.24	Ø 4.0 x 24 mm; fully threaded; self drilling; self tapping; titanium	 4 047075 098163
3.445.26	Ø 4.0 x 26 mm; fully threaded; self drilling; self tapping; titanium	 4 047075 098057
3.445.28	Ø 4.0 x 28 mm; fully threaded; self drilling; self tapping; titanium	 4 047075 098064
3.445.30	Ø 4.0 x 30 mm; fully threaded; self drilling; self tapping; titanium	 4 047075 098088
3.445.32	Ø 4.0 x 32 mm; fully threaded; self drilling; self tapping; titanium	 4 047075 098255
3.445.34	Ø 4.0 x 34 mm; fully threaded; self drilling; self tapping; titanium	 4 047075 098262
3.445.35	Ø 4.0 x 35 mm; fully threaded; self drilling; self tapping; titanium	 4 047075 098279
3.445.36	Ø 4.0 x 36 mm; fully threaded; self drilling; self tapping; titanium	 4 047075 098170
3.445.38	Ø 4.0 x 38 mm; fully threaded; self drilling; self tapping; titanium	 4 047075 098293
3.445.40	Ø 4.0 x 40 mm; fully threaded; self drilling; self tapping; titanium	 4 047075 098187
3.445.42	Ø 4.0 x 42 mm; fully threaded; self drilling; self tapping; titanium	 4 047075 098194
3.445.44	Ø 4.0 x 44 mm; fully threaded; self drilling; self tapping; titanium	 4 047075 098200
3.445.45	Ø 4.0 x 45 mm; fully threaded; self drilling; self tapping; titanium	 4 047075 098286
3.445.46	Ø 4.0 x 46 mm; fully threaded; self drilling; self tapping; titanium	 4 047075 098392
3.445.48	Ø 4.0 x 48 mm; fully threaded; self drilling; self tapping; titanium	 4 047075 098309
3.445.50	Ø 4.0 x 50 mm; fully threaded; self drilling; self tapping; titanium	 4 047075 098316
3.445.55	Ø 4.0 x 55 mm; fully threaded; self drilling; self tapping; titanium	 4 047075 098323
3.445.60	Ø 4.0 x 60 mm; fully threaded; self drilling; self tapping; titanium	 4 047075 098217
3.445.65	Ø 4.0 x 65 mm; fully threaded; self drilling; self tapping; titanium	 4 047075 098224
3.445.70	Ø 4.0 x 70 mm; fully threaded; self drilling; self tapping; titanium	 4 047075 098248
Cannulated screw 4.5 partial thread st		
3.430.20	Ø 4.5 x 20 mm; thread 7; self tapping; titanium	 4 047075 097258
3.430.22	Ø 4.5 x 22 mm; thread 7; self tapping; titanium	 4 047075 097265
3.430.24	Ø 4.5 x 24 mm; thread 8; self tapping; titanium	 4 047075 097272
3.430.26	Ø 4.5 x 26 mm; thread 9; self tapping; titanium	 4 047075 097166
3.430.28	Ø 4.5 x 28 mm; thread 9; self tapping; titanium	 4 047075 097173
3.430.30	Ø 4.5 x 30 mm; thread 10; self tapping; titanium	 4 047075 097203
3.430.32	Ø 4.5 x 32 mm; thread 11; self tapping; titanium	 4 047075 097210
3.430.34	Ø 4.5 x 34 mm; thread 11; self tapping; titanium	 4 047075 097227
3.430.36	Ø 4.5 x 36 mm; thread 12; self tapping; titanium	 4 047075 097388

























Cannulated screws

titanium

Item no.	Item description	EAN
3.430.38	Ø 4.5 x 38 mm; thread 13; self tapping; titanium	
3.430.40	Ø 4.5 x 40 mm; thread 13; self tapping; titanium	
3.430.42	Ø 4.5 x 42 mm; thread 14; self tapping; titanium	
3.430.44	Ø 4.5 x 44 mm; thread 15; self tapping; titanium	
3.430.46	Ø 4.5 x 46 mm; thread 15; self tapping; titanium	
3.430.48	Ø 4.5 x 48 mm; thread 16; self tapping; titanium	
3.430.50	Ø 4.5 x 50 mm; thread 16; self tapping; titanium	
3.430.52	Ø 4.5 x 52 mm; thread 17; self tapping; titanium	
3.430.54	Ø 4.5 x 54 mm; thread 19; self tapping; titanium	
3.430.56	Ø 4.5 x 56 mm; thread 19; self tapping; titanium	
3.430.58	Ø 4.5 x 58 mm; thread 20; self tapping; titanium	
3.430.60	Ø 4.5 x 60 mm; thread 20; self tapping; titanium	
3.430.62	Ø 4.5 x 62 mm; thread 21; self tapping; titanium	
3.430.64	Ø 4.5 x 64 mm; thread 21; self tapping; titanium	
3.430.66	Ø 4.5 x 66 mm; thread 22; self tapping; titanium	
3.430.68	Ø 4.5 x 68 mm; thread 23; self tapping; titanium	
3.430.72	Ø 4.5 x 72 mm; thread 24; self tapping; titanium	
Cannulated screw 4.5 partial thread st bt sd		
3.434.20	Ø 4.5 x 20 mm; thread 7; self drilling; back tapping; self tapping; titanium	
3.434.22	Ø 4.5 x 22 mm; thread 7; self drilling; back tapping; self tapping; titanium	
3.434.24	Ø 4.5 x 24 mm; thread 8; self drilling; back tapping; self tapping; titanium	
3.434.26	Ø 4.5 x 26 mm; thread 9; self drilling; back tapping; self tapping; titanium	
3.434.28	Ø 4.5 x 28 mm; thread 9; self drilling; back tapping; self tapping; titanium	
3.434.30	Ø 4.5 x 30 mm; thread 10; self drilling; back tapping; self tapping; titanium	
3.434.32	Ø 4.5 x 32 mm; thread 11; self drilling; back tapping; self tapping; titanium	
3.434.34	Ø 4.5 x 34 mm; thread 11; self drilling; back tapping; self tapping; titanium	
3.434.36	Ø 4.5 x 36 mm; thread 12; self drilling; back tapping; self tapping; titanium	
3.434.38	Ø 4.5 x 38 mm; thread 13; self drilling; back tapping; self tapping; titanium	
3.434.40	Ø 4.5 x 40 mm; thread 13; self drilling; back tapping; self tapping; titanium	
3.434.42	Ø 4.5 x 42 mm; thread 14; self drilling; back tapping; self tapping; titanium	
3.434.44	Ø 4.5 x 44 mm; thread 15; self drilling; back tapping; self tapping; titanium	
3.434.46	Ø 4.5 x 46 mm; thread 15; self drilling; back tapping; self tapping; titanium	
3.434.48	Ø 4.5 x 48 mm; thread 16; self drilling; back tapping; self tapping; titanium	
3.434.50	Ø 4.5 x 50 mm; thread 16; self drilling; back tapping; self tapping; titanium	















Cannulated screws

titanium

Item no.	Item description	EAN
3.434.52	Ø 4.5 x 52 mm; thread 17; self drilling; back tapping; self tapping; titanium	 4 047075 001705
3.434.54	Ø 4.5 x 54 mm; thread 19; self drilling; back tapping; self tapping; titanium	 4 047075 001712
3.434.56	Ø 4.5 x 56 mm; thread 19; self drilling; back tapping; self tapping; titanium	 4 047075 001729
3.434.58	Ø 4.5 x 58 mm; thread 20; self drilling; back tapping; self tapping; titanium	 4 047075 001736
3.434.60	Ø 4.5 x 60 mm; thread 20; self drilling; back tapping; self tapping; titanium	 4 047075 001743
3.434.62	Ø 4.5 x 62 mm; thread 21; self drilling; back tapping; self tapping; titanium	 4 047075 001750
3.434.64	Ø 4.5 x 64 mm; thread 21; self drilling; back tapping; self tapping; titanium	 4 047075 001767
3.434.66	Ø 4.5 x 66 mm; thread 22; self drilling; back tapping; self tapping; titanium	 4 047075 001774
3.434.68	Ø 4.5 x 68 mm; thread 23; self drilling; back tapping; self tapping; titanium	 4 047075 001781
3.434.72	Ø 4.5 x 72 mm; thread 24; self drilling; back tapping; self tapping; titanium	 4 047075 001798
Cannulated screw 4.5 st		
3.435.20	Ø 4.5 x 20 mm; fully threaded; self tapping; titanium	 4 047075 097395
3.435.22	Ø 4.5 x 22 mm; fully threaded; self tapping; titanium	 4 047075 097500
3.435.24	Ø 4.5 x 24 mm; fully threaded; self tapping; titanium	 4 047075 097579
3.435.26	Ø 4.5 x 26 mm; fully threaded; self tapping; titanium	 4 047075 097586
3.435.28	Ø 4.5 x 28 mm; fully threaded; self tapping; titanium	 4 047075 097593
3.435.30	Ø 4.5 x 30 mm; fully threaded; self tapping; titanium	 4 047075 097487
3.435.32	Ø 4.5 x 32 mm; fully threaded; self tapping; titanium	 4 047075 097494
3.435.34	Ø 4.5 x 34 mm; fully threaded; self tapping; titanium	 4 047075 097517
3.435.36	Ø 4.5 x 36 mm; fully threaded; self tapping; titanium	 4 047075 097524
3.435.38	Ø 4.5 x 38 mm; fully threaded; self tapping; titanium	 4 047075 097531
3.435.40	Ø 4.5 x 40 mm; fully threaded; self tapping; titanium	 4 047075 097708
3.435.42	Ø 4.5 x 42 mm; fully threaded; self tapping; titanium	 4 047075 097609
3.435.44	Ø 4.5 x 44 mm; fully threaded; self tapping; titanium	 4 047075 097739
3.435.46	Ø 4.5 x 46 mm; fully threaded; self tapping; titanium	 4 047075 097616
3.435.48	Ø 4.5 x 48 mm; fully threaded; self tapping; titanium	 4 047075 097623
3.435.50	Ø 4.5 x 50 mm; fully threaded; self tapping; titanium	 4 047075 097630
3.435.52	Ø 4.5 x 52 mm; fully threaded; self tapping; titanium	 4 047075 097555
3.435.54	Ø 4.5 x 54 mm; fully threaded; self tapping; titanium	 4 047075 097661
3.435.56	Ø 4.5 x 56 mm; fully threaded; self tapping; titanium	 4 047075 097753
3.435.58	Ø 4.5 x 58 mm; fully threaded; self tapping; titanium	 4 047075 097760
3.435.60	Ø 4.5 x 60 mm; fully threaded; self tapping; titanium	 4 047075 097777
3.435.62	Ø 4.5 x 62 mm; fully threaded; self tapping; titanium	 4 047075 097647
3.435.64	Ø 4.5 x 64 mm; fully threaded; self tapping; titanium	 4 047075 097654

































Cannulated screws

titanium

Item no.	Item description	EAN
3.435.66	Ø 4.5 x 66 mm; fully threaded; self tapping; titanium	 4 047075 097678
3.435.68	Ø 4.5 x 68 mm; fully threaded; self tapping; titanium	 4 047075 097685
3.435.72	Ø 4.5 x 72 mm; fully threaded; self tapping; titanium	 4 047075 097692
Cannulated screw 4.5 st sd		
3.439.20	Ø 4.5 x 20 mm; fully threaded; self drilling; self tapping; titanium	 4 047075 001804
3.439.22	Ø 4.5 x 22 mm; fully threaded; self drilling; self tapping; titanium	 4 047075 001811
3.439.24	Ø 4.5 x 24 mm; fully threaded; self drilling; self tapping; titanium	 4 047075 001828
3.439.26	Ø 4.5 x 26 mm; fully threaded; self drilling; self tapping; titanium	 4 047075 001835
3.439.28	Ø 4.5 x 28 mm; fully threaded; self drilling; self tapping; titanium	 4 047075 001842
3.439.30	Ø 4.5 x 30 mm; fully threaded; self drilling; self tapping; titanium	 4 047075 001859
3.439.32	Ø 4.5 x 32 mm; fully threaded; self drilling; self tapping; titanium	 4 047075 001866
3.439.34	Ø 4.5 x 34 mm; fully threaded; self drilling; self tapping; titanium	 4 047075 001873
3.439.36	Ø 4.5 x 36 mm; fully threaded; self drilling; self tapping; titanium	 4 047075 001880
3.439.38	Ø 4.5 x 38 mm; fully threaded; self drilling; self tapping; titanium	 4 047075 001897
3.439.40	Ø 4.5 x 40 mm; fully threaded; self drilling; self tapping; titanium	 4 047075 050345
3.439.42	Ø 4.5 x 42 mm; fully threaded; self drilling; self tapping; titanium	 4 047075 050352
3.439.44	Ø 4.5 x 44 mm; fully threaded; self drilling; self tapping; titanium	 4 047075 050369
3.439.46	Ø 4.5 x 46 mm; fully threaded; self drilling; self tapping; titanium	 4 047075 050376
3.439.48	Ø 4.5 x 48 mm; fully threaded; self drilling; self tapping; titanium	 4 047075 050383
3.439.50	Ø 4.5 x 50 mm; fully threaded; self drilling; self tapping; titanium	 4 047075 050390
3.439.52	Ø 4.5 x 52 mm; fully threaded; self drilling; self tapping; titanium	 4 047075 050406
3.439.54	Ø 4.5 x 54 mm; fully threaded; self drilling; self tapping; titanium	 4 047075 050413
3.439.56	Ø 4.5 x 56 mm; fully threaded; self drilling; self tapping; titanium	 4 047075 050420
3.439.58	Ø 4.5 x 58 mm; fully threaded; self drilling; self tapping; titanium	 4 047075 050437
3.439.60	Ø 4.5 x 60 mm; fully threaded; self drilling; self tapping; titanium	 4 047075 050444
3.439.62	Ø 4.5 x 62 mm; fully threaded; self drilling; self tapping; titanium	 4 047075 050451
3.439.64	Ø 4.5 x 64 mm; fully threaded; self drilling; self tapping; titanium	 4 047075 050468
3.439.66	Ø 4.5 x 66 mm; fully threaded; self drilling; self tapping; titanium	 4 047075 050475
3.439.68	Ø 4.5 x 68 mm; fully threaded; self drilling; self tapping; titanium	 4 047075 050482
3.439.72	Ø 4.5 x 72 mm; fully threaded; self drilling; self tapping; titanium	 4 047075 050499
Cannulated screw 6.5 thread 16 st bt sd – TiOB®		
3.520.30	Ø 6.5 x 30 mm; thread 16; self drilling; back tapping; self tapping; titanium	 4 047075 099962
3.520.35	Ø 6.5 x 35 mm; thread 16; self drilling; back tapping; self tapping; titanium	 4 047075 100040
3.520.40	Ø 6.5 x 40 mm; thread 16; self drilling; back tapping; self tapping; titanium	 4 047075 100156







Cannulated screws

titanium

Item no.	Item description	EAN
3.520.45	Ø 6.5 x 45 mm; thread 16; self drilling; back tapping; self tapping; titanium	 4 047075 100064
3.520.50	Ø 6.5 x 50 mm; thread 16; self drilling; back tapping; self tapping; titanium	 4 047075 100071
3.520.55	Ø 6.5 x 55 mm; thread 16; self drilling; back tapping; self tapping; titanium	 4 047075 100088
3.520.60	Ø 6.5 x 60 mm; thread 16; self drilling; back tapping; self tapping; titanium	 4 047075 099979
3.520.65	Ø 6.5 x 65 mm; thread 16; self drilling; back tapping; self tapping; titanium	 4 047075 099986
3.520.70	Ø 6.5 x 70 mm; thread 16; self drilling; back tapping; self tapping; titanium	 4 047075 100002
3.520.75	Ø 6.5 x 75 mm; thread 16; self drilling; back tapping; self tapping; titanium	 4 047075 100170
3.520.80	Ø 6.5 x 80 mm; thread 16; self drilling; back tapping; self tapping; titanium	 4 047075 100187
3.520.85	Ø 6.5 x 85 mm; thread 16; self drilling; back tapping; self tapping; titanium	 4 047075 100194
3.520.90	Ø 6.5 x 90 mm; thread 16; self drilling; back tapping; self tapping; titanium	 4 047075 100095
3.520.95	Ø 6.5 x 95 mm; thread 16; self drilling; back tapping; self tapping; titanium	 4 047075 100217
3.520.100	Ø 6.5 x 100 mm; thread 16; self drilling; back tapping; self tapping; titanium	 4 047075 099825
3.520.105	Ø 6.5 x 105 mm; thread 16; self drilling; back tapping; self tapping; titanium	 4 047075 099849
3.520.110	Ø 6.5 x 110 mm; thread 16; self drilling; back tapping; self tapping; titanium	 4 047075 100019
3.520.115	Ø 6.5 x 115 mm; thread 16; self drilling; back tapping; self tapping; titanium	 4 047075 100026
3.520.120	Ø 6.5 x 120 mm; thread 16; self drilling; back tapping; self tapping; titanium	 4 047075 100033
3.520.125	Ø 6.5 x 125 mm; thread 16; self drilling; back tapping; self tapping; titanium	 4 047075 099931
3.520.130	Ø 6.5 x 130 mm; thread 16; self drilling; back tapping; self tapping; titanium	 4 047075 100057
3.520.135	Ø 6.5 x 135 mm; thread 16; self drilling; back tapping; self tapping; titanium	 4 047075 099948
3.520.140	Ø 6.5 x 140 mm; thread 16; self drilling; back tapping; self tapping; titanium	 4 047075 099955
Cannulated screw 6.5 thread 32 st bt sd – TiOB®		
3.523.45	Ø 6.5 x 45 mm; thread 32; self drilling; back tapping; self tapping; titanium	 4 047075 100149
3.523.50	Ø 6.5 x 50 mm; thread 32; self drilling; back tapping; self tapping; titanium	 4 047075 100163
3.523.55	Ø 6.5 x 55 mm; thread 32; self drilling; back tapping; self tapping; titanium	 4 047075 100330
3.523.60	Ø 6.5 x 60 mm; thread 32; self drilling; back tapping; self tapping; titanium	 4 047075 100347
3.523.65	Ø 6.5 x 65 mm; thread 32; self drilling; back tapping; self tapping; titanium	 4 047075 100354
3.523.70	Ø 6.5 x 70 mm; thread 32; self drilling; back tapping; self tapping; titanium	 4 047075 100255
3.523.75	Ø 6.5 x 75 mm; thread 32; self drilling; back tapping; self tapping; titanium	 4 047075 100378
3.523.80	Ø 6.5 x 80 mm; thread 32; self drilling; back tapping; self tapping; titanium	 4 047075 100262
3.523.85	Ø 6.5 x 85 mm; thread 32; self drilling; back tapping; self tapping; titanium	 4 047075 100279
3.523.90	Ø 6.5 x 90 mm; thread 32; self drilling; back tapping; self tapping; titanium	 4 047075 100286
3.523.95	Ø 6.5 x 95 mm; thread 32; self drilling; back tapping; self tapping; titanium	 4 047075 100361
3.523.100	Ø 6.5 x 100 mm; thread 32; self drilling; back tapping; self tapping; titanium	 4 047075 100101
3.523.105	Ø 6.5 x 105 mm; thread 32; self drilling; back tapping; self tapping; titanium	 4 047075 100118



Cannulated screws

titanium

Item no.	Item description	EAN
3.523.110	Ø 6.5 x 110 mm; thread 32; self drilling; back tapping; self tapping; titanium	 4 047075 100125
3.523.115	Ø 6.5 x 115 mm; thread 32; self drilling; back tapping; self tapping; titanium	 4 047075 100200
3.523.120	Ø 6.5 x 120 mm; thread 32; self drilling; back tapping; self tapping; titanium	 4 047075 100316
3.523.125	Ø 6.5 x 125 mm; thread 32; self drilling; back tapping; self tapping; titanium	 4 047075 100224
3.523.130	Ø 6.5 x 130 mm; thread 32; self drilling; back tapping; self tapping; titanium	 4 047075 100231
3.523.135	Ø 6.5 x 135 mm; thread 32; self drilling; back tapping; self tapping; titanium	 4 047075 100248
3.523.140	Ø 6.5 x 140 mm; thread 32; self drilling; back tapping; self tapping; titanium	 4 047075 100132
Cannulated screw 6.5 st bt sd – TiOB®		
3.525.45	Ø 6.5 x 45 mm; fully threaded; self drilling; back tapping; self tapping; titanium	 4 047075 100507
3.525.50	Ø 6.5 x 50 mm; fully threaded; self drilling; back tapping; self tapping; titanium	 4 047075 100415
3.525.55	Ø 6.5 x 55 mm; fully threaded; self drilling; back tapping; self tapping; titanium	 4 047075 100521
3.525.60	Ø 6.5 x 60 mm; fully threaded; self drilling; back tapping; self tapping; titanium	 4 047075 100422
3.525.65	Ø 6.5 x 65 mm; fully threaded; self drilling; back tapping; self tapping; titanium	 4 047075 100439
3.525.70	Ø 6.5 x 70 mm; fully threaded; self drilling; back tapping; self tapping; titanium	 4 047075 100446
3.525.75	Ø 6.5 x 75 mm; fully threaded; self drilling; back tapping; self tapping; titanium	 4 047075 100514
3.525.80	Ø 6.5 x 80 mm; fully threaded; self drilling; back tapping; self tapping; titanium	 4 047075 100644
3.525.85	Ø 6.5 x 85 mm; fully threaded; self drilling; back tapping; self tapping; titanium	 4 047075 100538
3.525.90	Ø 6.5 x 90 mm; fully threaded; self drilling; back tapping; self tapping; titanium	 4 047075 100545
3.525.95	Ø 6.5 x 95 mm; fully threaded; self drilling; back tapping; self tapping; titanium	 4 047075 100552
3.525.100	Ø 6.5 x 100 mm; fully threaded; self drilling; back tapping; self tapping; titanium	 4 047075 100460
3.525.105	Ø 6.5 x 105 mm; fully threaded; self drilling; back tapping; self tapping; titanium	 4 047075 100385
3.525.110	Ø 6.5 x 110 mm; fully threaded; self drilling; back tapping; self tapping; titanium	 4 047075 100392
3.525.115	Ø 6.5 x 115 mm; fully threaded; self drilling; back tapping; self tapping; titanium	 4 047075 100408
3.525.120	Ø 6.5 x 120 mm; fully threaded; self drilling; back tapping; self tapping; titanium	 4 047075 100293
3.525.125	Ø 6.5 x 125 mm; fully threaded; self drilling; back tapping; self tapping; titanium	 4 047075 100309
3.525.130	Ø 6.5 x 130 mm; fully threaded; self drilling; back tapping; self tapping; titanium	 4 047075 100323
3.525.135	Ø 6.5 x 135 mm; fully threaded; self drilling; back tapping; self tapping; titanium	 4 047075 100484
3.525.140	Ø 6.5 x 140 mm; fully threaded; self drilling; back tapping; self tapping; titanium	 4 047075 100491
Cannulated screw 7.0 thread 10 bt		
3.409.40	Ø 7.0 x 40 mm; thread 10; back tapping; titanium	 4 047075 095513
3.409.45	Ø 7.0 x 45 mm; thread 10; back tapping; titanium	 4 047075 095353
3.409.50	Ø 7.0 x 50 mm; thread 10; back tapping; titanium	 4 047075 095360
3.409.55	Ø 7.0 x 55 mm; thread 10; back tapping; titanium	 4 047075 095377
3.409.60	Ø 7.0 x 60 mm; thread 10; back tapping; titanium	 4 047075 095384

















Cannulated screws

titanium

Item no.	Item description	EAN
3.409.65	Ø 7.0 x 65 mm; thread 10; back tapping; titanium	 4 047075 095391
3.409.70	Ø 7.0 x 70 mm; thread 10; back tapping; titanium	 4 047075 095407
3.409.75	Ø 7.0 x 75 mm; thread 10; back tapping; titanium	 4 047075 095414
3.409.80	Ø 7.0 x 80 mm; thread 10; back tapping; titanium	 4 047075 095292
3.409.85	Ø 7.0 x 85 mm; thread 10; back tapping; titanium	 4 047075 095445
3.409.90	Ø 7.0 x 90 mm; thread 10; back tapping; titanium	 4 047075 095315
3.409.95	Ø 7.0 x 95 mm; thread 10; back tapping; titanium	 4 047075 095322
3.409.100	Ø 7.0 x 100 mm; thread 10; back tapping; titanium	 4 047075 095254
3.409.110	Ø 7.0 x 110 mm; thread 10; back tapping; titanium	 4 047075 095278
Cannulated screw 7.0 st sd		
3.411.50	Ø 7.0 x 50 mm; fully threaded; self drilling; self tapping; titanium	 4 047075 132010
3.411.55	Ø 7.0 x 55 mm; fully threaded; self drilling; self tapping; titanium	 4 047075 132027
3.411.60	Ø 7.0 x 60 mm; fully threaded; self drilling; self tapping; titanium	 4 047075 132034
3.411.65	Ø 7.0 x 65 mm; fully threaded; self drilling; self tapping; titanium	 4 047075 132041
3.411.70	Ø 7.0 x 70 mm; fully threaded; self drilling; self tapping; titanium	 4 047075 132058
3.411.75	Ø 7.0 x 75 mm; fully threaded; self drilling; self tapping; titanium	 4 047075 132065
3.411.80	Ø 7.0 x 80 mm; fully threaded; self drilling; self tapping; titanium	 4 047075 132072
3.411.85	Ø 7.0 x 85 mm; fully threaded; self drilling; self tapping; titanium	 4 047075 132089
3.411.90	Ø 7.0 x 90 mm; fully threaded; self drilling; self tapping; titanium	 4 047075 132096
Cannulated screw 7.0 thread 16 st bt		
3.412.30	Ø 7.0 x 30 mm; thread 16; back tapping; self tapping; titanium	 4 047075 095667
3.412.35	Ø 7.0 x 35 mm; thread 16; back tapping; self tapping; titanium	 4 047075 095681
3.412.40	Ø 7.0 x 40 mm; thread 16; back tapping; self tapping; titanium	 4 047075 095698
3.412.45	Ø 7.0 x 45 mm; thread 16; back tapping; self tapping; titanium	 4 047075 095841
3.412.50	Ø 7.0 x 50 mm; thread 16; back tapping; self tapping; titanium	 4 047075 095858
3.412.55	Ø 7.0 x 55 mm; thread 16; back tapping; self tapping; titanium	 4 047075 095759
3.412.60	Ø 7.0 x 60 mm; thread 16; back tapping; self tapping; titanium	 4 047075 095872
3.412.65	Ø 7.0 x 65 mm; thread 16; back tapping; self tapping; titanium	 4 047075 095766
3.412.70	Ø 7.0 x 70 mm; thread 16; back tapping; self tapping; titanium	 4 047075 095773
3.412.75	Ø 7.0 x 75 mm; thread 16; back tapping; self tapping; titanium	 4 047075 095780
3.412.80	Ø 7.0 x 80 mm; thread 16; back tapping; self tapping; titanium	 4 047075 095711
3.412.85	Ø 7.0 x 85 mm; thread 16; back tapping; self tapping; titanium	 4 047075 095889
3.412.90	Ø 7.0 x 90 mm; thread 16; back tapping; self tapping; titanium	 4 047075 095896
3.412.95	Ø 7.0 x 95 mm; thread 16; back tapping; self tapping; titanium	 4 047075 095902

Cannulated screws

titanium

Item no.	Item description	EAN
3.412.100	Ø 7.0 x 100 mm; thread 16; back tapping; self tapping; titanium	
3.412.105	Ø 7.0 x 105 mm; thread 16; back tapping; self tapping; titanium	
3.412.110	Ø 7.0 x 110 mm; thread 16; back tapping; self tapping; titanium	
3.412.115	Ø 7.0 x 115 mm; thread 16; back tapping; self tapping; titanium	
3.412.120	Ø 7.0 x 120 mm; thread 16; back tapping; self tapping; titanium	
3.412.125	Ø 7.0 x 125 mm; thread 16; back tapping; self tapping; titanium	
3.412.130	Ø 7.0 x 130 mm; thread 16; back tapping; self tapping; titanium	
Cannulated screw 7.0 thread 16 st bt sd		
3.414.30	Ø 7.0 x 30 mm; thread 16; self drilling; back tapping; self tapping; titanium	
3.414.35	Ø 7.0 x 35 mm; thread 16; self drilling; back tapping; self tapping; titanium	
3.414.40	Ø 7.0 x 40 mm; thread 16; self drilling; back tapping; self tapping; titanium	
3.414.45	Ø 7.0 x 45 mm; thread 16; self drilling; back tapping; self tapping; titanium	
3.414.50	Ø 7.0 x 50 mm; thread 16; self drilling; back tapping; self tapping; titanium	
3.414.55	Ø 7.0 x 55 mm; thread 16; self drilling; back tapping; self tapping; titanium	
3.414.60	Ø 7.0 x 60 mm; thread 16; self drilling; back tapping; self tapping; titanium	
3.414.65	Ø 7.0 x 65 mm; thread 16; self drilling; back tapping; self tapping; titanium	
3.414.70	Ø 7.0 x 70 mm; thread 16; self drilling; back tapping; self tapping; titanium	
3.414.75	Ø 7.0 x 75 mm; thread 16; self drilling; back tapping; self tapping; titanium	
3.414.80	Ø 7.0 x 80 mm; thread 16; self drilling; back tapping; self tapping; titanium	
3.414.85	Ø 7.0 x 85 mm; thread 16; self drilling; back tapping; self tapping; titanium	
3.414.90	Ø 7.0 x 90 mm; thread 16; self drilling; back tapping; self tapping; titanium	
3.414.95	Ø 7.0 x 95 mm; thread 16; self drilling; back tapping; self tapping; titanium	
3.414.100	Ø 7.0 x 100 mm; thread 16; self drilling; back tapping; self tapping; titanium	
3.414.105	Ø 7.0 x 105 mm; thread 16; self drilling; back tapping; self tapping; titanium	
3.414.110	Ø 7.0 x 110 mm; thread 16; self drilling; back tapping; self tapping; titanium	
3.414.115	Ø 7.0 x 115 mm; thread 16; self drilling; back tapping; self tapping; titanium	
3.414.120	Ø 7.0 x 120 mm; thread 16; self drilling; back tapping; self tapping; titanium	
3.414.125	Ø 7.0 x 125 mm; thread 16; self drilling; back tapping; self tapping; titanium	
3.414.130	Ø 7.0 x 130 mm; thread 16; self drilling; back tapping; self tapping; titanium	
Cannulated screw 7.0 thread 32 st bt		
3.422.40	Ø 7.0 x 40 mm; thread 32; back tapping; self tapping; titanium	
3.422.45	Ø 7.0 x 45 mm; thread 32; back tapping; self tapping; titanium	
3.422.50	Ø 7.0 x 50 mm; thread 32; back tapping; self tapping; titanium	
3.422.55	Ø 7.0 x 55 mm; thread 32; back tapping; self tapping; titanium	

Cannulated screws

titanium

Item no.	Item description	EAN
3.422.60	Ø 7.0 x 60 mm; thread 32; back tapping; self tapping; titanium	 4 047075 096329
3.422.65	Ø 7.0 x 65 mm; thread 32; back tapping; self tapping; titanium	 4 047075 096497
3.422.70	Ø 7.0 x 70 mm; thread 32; back tapping; self tapping; titanium	 4 047075 096404
3.422.75	Ø 7.0 x 75 mm; thread 32; back tapping; self tapping; titanium	 4 047075 096510
3.422.80	Ø 7.0 x 80 mm; thread 32; back tapping; self tapping; titanium	 4 047075 096411
3.422.85	Ø 7.0 x 85 mm; thread 32; back tapping; self tapping; titanium	 4 047075 096428
3.422.90	Ø 7.0 x 90 mm; thread 32; back tapping; self tapping; titanium	 4 047075 096435
3.422.95	Ø 7.0 x 95 mm; thread 32; back tapping; self tapping; titanium	 4 047075 096343
3.422.100	Ø 7.0 x 100 mm; thread 32; back tapping; self tapping; titanium	 4 047075 096244
3.422.105	Ø 7.0 x 105 mm; thread 32; back tapping; self tapping; titanium	 4 047075 096251
3.422.110	Ø 7.0 x 110 mm; thread 32; back tapping; self tapping; titanium	 4 047075 096268
3.422.115	Ø 7.0 x 115 mm; thread 32; back tapping; self tapping; titanium	 4 047075 096183
3.422.120	Ø 7.0 x 120 mm; thread 32; back tapping; self tapping; titanium	 4 047075 096299
3.422.125	Ø 7.0 x 125 mm; thread 32; back tapping; self tapping; titanium	 4 047075 096374
3.422.130	Ø 7.0 x 130 mm; thread 32; back tapping; self tapping; titanium	 4 047075 096381
Cannulated screw 7.0 thread 32 st bt sd		
3.424.40	Ø 7.0 x 40 mm; thread 32; self drilling; back tapping; self tapping; titanium	 4 047075 096473
3.424.45	Ø 7.0 x 45 mm; thread 32; self drilling; back tapping; self tapping; titanium	 4 047075 096480
3.424.50	Ø 7.0 x 50 mm; thread 32; self drilling; back tapping; self tapping; titanium	 4 047075 096657
3.424.55	Ø 7.0 x 55 mm; thread 32; self drilling; back tapping; self tapping; titanium	 4 047075 096558
3.424.60	Ø 7.0 x 60 mm; thread 32; self drilling; back tapping; self tapping; titanium	 4 047075 096688
3.424.65	Ø 7.0 x 65 mm; thread 32; self drilling; back tapping; self tapping; titanium	 4 047075 096572
3.424.70	Ø 7.0 x 70 mm; thread 32; self drilling; back tapping; self tapping; titanium	 4 047075 096589
3.424.75	Ø 7.0 x 75 mm; thread 32; self drilling; back tapping; self tapping; titanium	 4 047075 096596
3.424.80	Ø 7.0 x 80 mm; thread 32; self drilling; back tapping; self tapping; titanium	 4 047075 096503
3.424.85	Ø 7.0 x 85 mm; thread 32; self drilling; back tapping; self tapping; titanium	 4 047075 096619
3.424.90	Ø 7.0 x 90 mm; thread 32; self drilling; back tapping; self tapping; titanium	 4 047075 096701
3.424.95	Ø 7.0 x 95 mm; thread 32; self drilling; back tapping; self tapping; titanium	 4 047075 096718
3.424.100	Ø 7.0 x 100 mm; thread 32; self drilling; back tapping; self tapping; titanium	 4 047075 096367
3.424.105	Ø 7.0 x 105 mm; thread 32; self drilling; back tapping; self tapping; titanium	 4 047075 096527
3.424.110	Ø 7.0 x 110 mm; thread 32; self drilling; back tapping; self tapping; titanium	 4 047075 096534
3.424.115	Ø 7.0 x 115 mm; thread 32; self drilling; back tapping; self tapping; titanium	 4 047075 096541
3.424.120	Ø 7.0 x 120 mm; thread 32; self drilling; back tapping; self tapping; titanium	 4 047075 096442
3.424.125	Ø 7.0 x 125 mm; thread 32; self drilling; back tapping; self tapping; titanium	 4 047075 096565







Cannulated screws

titanium

Item no.	Item description	EAN
3.424.130	Ø 7.0 x 130 mm; thread 32; self drilling; back tapping; self tapping; titanium	 4 047075 096466
Cannulated screw 7.0 bt		
3.425.30	Ø 7.0 x 30 mm; fully threaded; back tapping; titanium	 4 047075 096862
3.425.35	Ø 7.0 x 35 mm; fully threaded; back tapping; titanium	 4 047075 096770
3.425.45	Ø 7.0 x 45 mm; fully threaded; back tapping; titanium	 4 047075 096794
3.425.50	Ø 7.0 x 50 mm; fully threaded; back tapping; titanium	 4 047075 096664
3.425.55	Ø 7.0 x 55 mm; fully threaded; back tapping; titanium	 4 047075 096671
3.425.60	Ø 7.0 x 60 mm; fully threaded; back tapping; titanium	 4 047075 096695
3.425.70	Ø 7.0 x 70 mm; fully threaded; back tapping; titanium	 4 047075 096893
3.425.75	Ø 7.0 x 75 mm; fully threaded; back tapping; titanium	 4 047075 096909
3.425.80	Ø 7.0 x 80 mm; fully threaded; back tapping; titanium	 4 047075 096800
3.425.85	Ø 7.0 x 85 mm; fully threaded; back tapping; titanium	 4 047075 096923
3.425.90	Ø 7.0 x 90 mm; fully threaded; back tapping; titanium	 4 047075 096817
3.425.95	Ø 7.0 x 95 mm; fully threaded; back tapping; titanium	 4 047075 096824
3.425.100	Ø 7.0 x 100 mm; fully threaded; back tapping; titanium	 4 047075 096749
3.425.105	Ø 7.0 x 105 mm; fully threaded; back tapping; titanium	 4 047075 096602
3.425.110	Ø 7.0 x 110 mm; fully threaded; back tapping; titanium	 4 047075 096763
3.425.115	Ø 7.0 x 115 mm; fully threaded; back tapping; titanium	 4 047075 096626
3.425.125	Ø 7.0 x 125 mm; fully threaded; back tapping; titanium	 4 047075 096640
3.425.130	Ø 7.0 x 130 mm; fully threaded; back tapping; titanium	 4 047075 096756
Cannulated screw 7.0 st bt		
3.427.30	Ø 7.0 x 30 mm; fully threaded; back tapping; self tapping; titanium	 4 047075 096855
3.427.40	Ø 7.0 x 40 mm; fully threaded; back tapping; self tapping; titanium	 4 047075 097067
3.427.45	Ø 7.0 x 45 mm; fully threaded; back tapping; self tapping; titanium	 4 047075 097074
3.427.50	Ø 7.0 x 50 mm; fully threaded; back tapping; self tapping; titanium	 4 047075 097081
3.427.55	Ø 7.0 x 55 mm; fully threaded; back tapping; self tapping; titanium	 4 047075 096961
3.427.60	Ø 7.0 x 60 mm; fully threaded; back tapping; self tapping; titanium	 4 047075 097104
3.427.65	Ø 7.0 x 65 mm; fully threaded; back tapping; self tapping; titanium	 4 047075 096978
3.427.70	Ø 7.0 x 70 mm; fully threaded; back tapping; self tapping; titanium	 4 047075 096985
3.427.75	Ø 7.0 x 75 mm; fully threaded; back tapping; self tapping; titanium	 4 047075 096992
3.427.80	Ø 7.0 x 80 mm; fully threaded; back tapping; self tapping; titanium	 4 047075 097098
3.427.85	Ø 7.0 x 85 mm; fully threaded; back tapping; self tapping; titanium	 4 047075 097241
3.427.90	Ø 7.0 x 90 mm; fully threaded; back tapping; self tapping; titanium	 4 047075 097111
3.427.95	Ø 7.0 x 95 mm; fully threaded; back tapping; self tapping; titanium	 4 047075 097128

Cannulated screws

titanium

Item no.	Item description	EAN
3.427.100	Ø 7.0 x 100 mm; fully threaded; back tapping; self tapping; titanium	
3.427.105	Ø 7.0 x 105 mm; fully threaded; back tapping; self tapping; titanium	
3.427.110	Ø 7.0 x 110 mm; fully threaded; back tapping; self tapping; titanium	
3.427.115	Ø 7.0 x 115 mm; fully threaded; back tapping; self tapping; titanium	
3.427.120	Ø 7.0 x 120 mm; fully threaded; back tapping; self tapping; titanium	
3.427.125	Ø 7.0 x 125 mm; fully threaded; back tapping; self tapping; titanium	
3.427.130	Ø 7.0 x 130 mm; fully threaded; back tapping; self tapping; titanium	

Information

TiOB® is a trademark of Königsee Implantate GmbH registered in the EU countries, Switzerland and the USA. It is a surface treatment that brings optimized properties.



Königsee Implantate GmbH
 OT Aschau | Am Sand 4
 07426 Allendorf | Germany

Fon +49 36738 498-560
 Fax +49 36738 498-569

Mail export@koenigsee-implantate.de

For further information please visit:
www.koenigsee-implantate.com

Kr/Mo | Edition 04 | 2020-08
 All pictured products are CE compliant.

Set Cannulated screws 2.7 st sd

self tapping; self drilling; titanium; TiOB®; Set no. 19.170.00



Item no. 3.448.30



Item no. 3.450.30

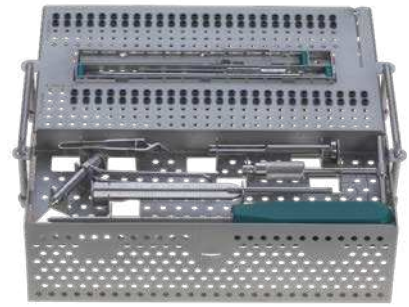

Set no. 19.170.00  Internal hexagon

Item no.	Item description	Quant.
Implants – screws		
Partial thread - Ø2.7 mm; self tapping; self drilling; titanium; TiOB®		
3.448.10	length 10 mm; thread 5	2
3.448.12	length 12 mm; thread 5	2
3.448.14	length 14 mm; thread 5	2
3.448.16	length 16 mm; thread 6	2
3.448.18	length 18 mm; thread 7	2
3.448.20	length 20 mm; thread 8	2
3.448.22	length 22 mm; thread 9	2
3.448.24	length 24 mm; thread 10	2
3.448.26	length 26 mm; thread 10	2
3.448.28	length 28 mm; thread 12	2
3.448.30	length 30 mm; thread 12	2
3.448.32	length 32 mm; thread 12	2
3.448.34	length 34 mm; thread 12	2
3.448.35	length 35 mm; thread 15	2
3.448.36	length 36 mm; thread 15	2
3.448.38	length 38 mm; thread 15	2
3.448.40	length 40 mm; thread 15	2
3.448.42	length 42 mm; thread 15	2
3.448.44	length 44 mm; thread 15	2
3.448.45	length 45 mm; thread 15	2
3.448.46	length 46 mm; thread 15	2
3.448.48	length 48 mm; thread 15	2
3.448.50	length 50 mm; thread 15	2
3.448.55	length 55 mm; thread 20	2
3.448.60	length 60 mm; thread 20	2

Item no.	Item description	Quant.
Implants – screws		
Full thread - Ø2.7 mm; self tapping; self drilling; titanium; TiOB®		
3.450.10	length 10 mm	2
3.450.12	length 12 mm	2
3.450.14	length 14 mm	2
3.450.16	length 16 mm	2
3.450.18	length 18 mm	2
3.450.20	length 20 mm	2
3.450.22	length 22 mm	2
3.450.24	length 24 mm	2
3.450.26	length 26 mm	2
3.450.28	length 28 mm	2
3.450.30	length 30 mm	2
3.450.32	length 32 mm	2
3.450.34	length 34 mm	2
3.450.35	length 35 mm	2
3.450.36	length 36 mm	2
3.450.38	length 38 mm	2
3.450.40	length 40 mm	2
3.450.42	length 42 mm	2
3.450.44	length 44 mm	2
3.450.45	length 45 mm	2
3.450.46	length 46 mm	2
3.450.48	length 48 mm	2
3.450.50	length 50 mm	2
3.450.55	length 55 mm	2
3.450.60	length 60 mm	2

Set Cannulated screws 2.7 st sd

self tapping; self drilling; titanium; TiOB®; Set no. 19.170.00

Item no.	Item description	Quant.
Instruments		
2.950.150	gauge for cannulated screws Ø 2.7 to 4.0 mm; length 150 mm	1
10.306.06	Handle with quick coupling; length 93.5 mm; cannulated; inside Ø 2.5 mm	1
10.927.00	percutaneous drill bush system for cannulated screws Ø 2.7 mm	1
2.906.27	pilot drill bit for quick coupling; Ø 2.2 x 100 mm; bore length 60 mm; cannulated; inside Ø 1.5 mm	1
2.907.27	countersink; Ø 5.0 x 160 mm; cannulated; inside Ø 1.5 mm; for cannulated screws Ø 2.7 mm	1
2.9436.40	hex screwdriver with handle for Ø 2.7 - 4.0 mm; cannulated; inside Ø 1.7 mm; wrench size 2.5 mm; lengt 215 mm	1
2.954.01	screw forceps; self holding	1
2.954.27A	holding sleeve for screws Ø 2.7 to 3.5 mm	1
2.955.14	cleaning wire Ø 1.4 mm for cannulated instruments	1
20.502.01	holding clamp; small	1

Item no.	Item description	Quant.
Wires		
2.978.14	guide wire; Ø 1.4 x 150 mm; thread 5; stainless steel	5

Implants – washers		
3.200.10	washer; outside Ø 6.0 mm / inside Ø 3.0 mm; titanium	5

Container		
19.171.00	perforated autoclavable container with inset for instruments/cannulated screws Ø 2.7 mm	1

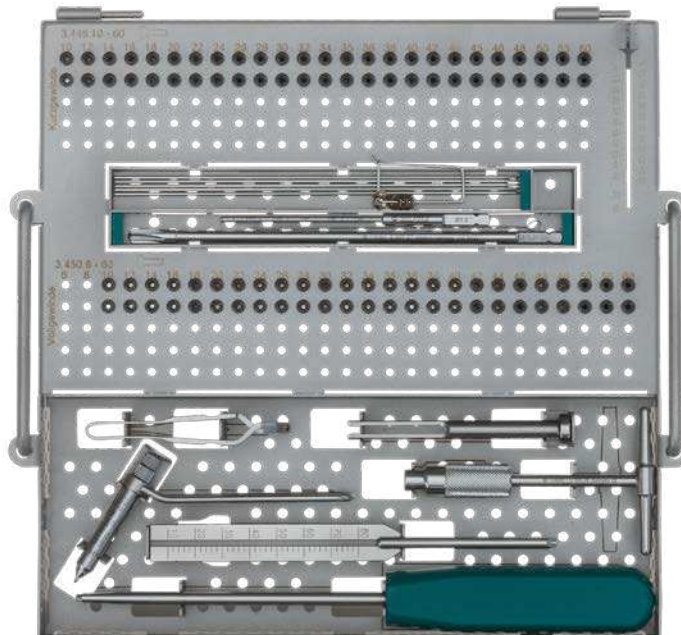

Set no. 19.170.00  Internal hexagon

Information

TiOB® is a trademark of Königsee Implantate GmbH registered in the EU countries, Switzerland and the USA. It is a surface treatment that brings optimized properties.



Königsee Implantate GmbH
OT Aschau | Am Sand 4
07426 Allendorf | Germany

Fon +49 36738 498-560
Fax +49 36738 498-569

Mail export@koenigsee-implantate.de

For further information please visit:
www.koenigsee-implantate.com

KrMo | Edition 04 | 2020-08
All pictured products are CE compliant.

Set Cannulated screws 3.5 st

self tapping; titanium; Set no. 19.181.00



Item no. 3.502.30



Item no. 3.602.30

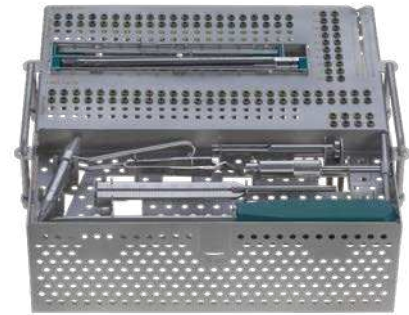

Set no. 19.181.00  Internal hexagon

Item no.	Item description	Quant.
Implants – screws		
Partial thread - Ø3.5 mm; self tapping; titanium		
3.502.10	length 10 mm; thread 5	2
3.502.12	length 12 mm; thread 5	2
3.502.14	length 14 mm; thread 5	2
3.502.16	length 16 mm; thread 6	2
3.502.18	length 18 mm; thread 7	2
3.502.20	length 20 mm; thread 8	2
3.502.22	length 22 mm; thread 9	2
3.502.24	length 24 mm; thread 10	2
3.502.26	length 26 mm; thread 12	2
3.502.28	length 28 mm; thread 14	2
3.502.30	length 30 mm; thread 14	2
3.502.32	length 32 mm; thread 14	2
3.502.34	length 34 mm; thread 14	2
3.502.36	length 36 mm; thread 14	2
3.502.38	length 38 mm; thread 14	2
3.502.40	length 40 mm; thread 14	2
3.502.42	length 42 mm; thread 15	2
3.502.44	length 44 mm; thread 15	2
3.502.46	length 46 mm; thread 15	2
3.502.48	length 48 mm; thread 15	2
3.502.50	length 50 mm; thread 15	2
3.502.52	length 52 mm; thread 16	2
3.502.54	length 54 mm; thread 16	2
3.502.56	length 56 mm; thread 16	2

Item no.	Item description	Quant.
Implants – screws		
Full thread - Ø3.5 mm; self tapping; titanium		
3.602.10	length 10 mm	2
3.602.12	length 12 mm	2
3.602.14	length 14 mm	2
3.602.16	length 16 mm	2
3.602.18	length 18 mm	2
3.602.20	length 20 mm	2
3.602.22	length 22 mm	2
3.602.24	length 24 mm	2
3.602.26	length 26 mm	2
3.602.28	length 28 mm	2
3.602.30	length 30 mm	2
3.602.32	length 32 mm	2
3.602.34	length 34 mm	2
3.602.36	length 36 mm	2
3.602.38	length 38 mm	2
3.602.40	length 40 mm	2
3.602.42	length 42 mm	2
3.602.44	length 44 mm	2
3.602.46	length 46 mm	2
3.602.48	length 48 mm	2
3.602.50	length 50 mm	2
3.602.52	length 52 mm	2
3.602.54	length 54 mm	2
3.602.56	length 56 mm	2

Set Cannulated screws 3.5 st

self tapping; titanium; Set no. 19.181.00

Item no.	Item description	Quant.
3.502.58	length 58 mm; thread 16	2
3.502.60	length 60 mm; thread 16	2
3.502.62	length 62 mm; thread 17	2
3.502.64	length 64 mm; thread 17	2
3.502.66	length 66 mm; thread 17	2
3.502.68	length 68 mm; thread 17	2
3.502.70	length 70 mm; thread 17	2

Item no.	Item description	Quant.
3.602.58	length 58 mm	2
3.602.60	length 60 mm	2
3.602.62	length 62 mm	2
3.602.64	length 64 mm	2
3.602.66	length 66 mm	2
3.602.68	length 68 mm	2
3.602.70	length 70 mm	2

Instruments		
2.950.150	gauge for cannulated screws Ø 2.7 - 4.0 mm; length 150 mm	1
10.306.06	T-handle with quick coupling; length 93.5 mm; cannulated; inside Ø 2.5 mm	1
10.935.00	percutaneous drill bush system for cannulated screws Ø 3.5 mm	1
2.905.27	drill bit for quick coupling; Ø 2.7 x 160 mm; spiral length 30 mm; quadruple spiral; cannulated; inside Ø 1.35 mm	1
2.905.35	drill bit for quick coupling; Ø 3.5 x 160 mm; spiral length 30 mm; quadruple spiral; cannulated; inside Ø 1.35 mm	1
2.907.35	countersink; Ø 5.0 x 160 mm; cannulated; inside Ø 1.3 mm; for cannulated screws Ø 3.5 mm	1
2.923.35	tap for quick coupling; Ø 3.5 x 160 mm; cannulated; inside Ø 1.5 mm	1
2.9436.25	hex screwdriver with handle for Ø 2.7 - 4.0 mm; cannulated; inside Ø 1.3 mm; wrench size 2.5 mm; length 215 mm	1
2.954.01	screw forceps; self holding	1
2.954.27A	holding sleeve for screws Ø 2.7 - 3.5 mm	1
2.955.12	cleaning wire Ø 1.2 mm for cannulated instruments	
20.502.01	holding clamp; small	

Wires		
2.978.12	guide wire; Ø 1.2 x 150 mm; thread 5; stainless steel	5

Implants – washers		
3.200.02	washer; outside Ø 7.0 mm / inside Ø 3.8 mm; titanium	5

Container		
19.182.00	perforated autoclavable container with inset for instruments/cannulated screws Ø 3.5 mm	1

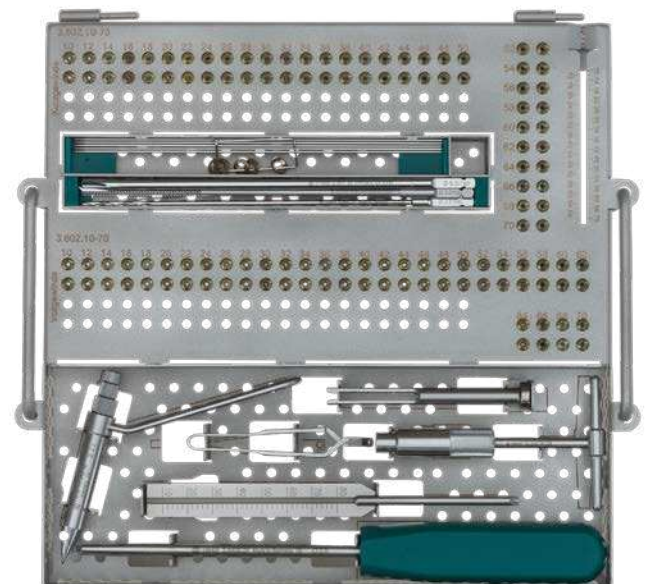

Set no. 19.181.00  Internal hexagon

Set Cannulated screws 3.5 st sd

self tapping; self drilling; titanium; Set no. 19.184.00



Item no. 3.504.30



Item no. 3.604.30

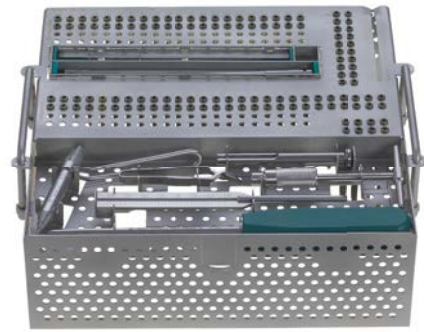

Set no. 19.184.00  Internal hexagon

Item no.	Item description	Quant.
Implants – screws		
Partial thread - Ø 3.5 mm; self drilling; back tapping; self tapping; titanium		
3.504.10	length 10 mm; thread 5	2
3.504.12	length 12 mm; thread 5	2
3.504.14	length 14 mm; thread 5	2
3.504.16	length 16 mm; thread 6	2
3.504.18	length 18 mm; thread 7	2
3.504.20	length 20 mm; thread 8	2
3.504.22	length 22 mm; thread 9	2
3.504.24	length 24 mm; thread 10	2
3.504.26	length 26 mm; thread 12	2
3.504.28	length 28 mm; thread 14	2
3.504.30	length 30 mm; thread 14	2
3.504.32	length 32 mm; thread 14	2
3.504.34	length 34 mm; thread 14	2
3.504.36	length 36 mm; thread 14	2
3.504.38	length 38 mm; thread 14	2
3.504.40	length 40 mm; thread 14	2
3.504.42	length 42 mm; thread 15	2
3.504.44	length 44 mm; thread 15	2
3.504.46	length 46 mm; thread 15	2
3.504.48	length 48 mm; thread 15	2
3.504.50	length 50 mm; thread 15	2
3.504.52	length 52 mm; thread 16	2
3.504.54	length 54 mm; thread 16	2
3.504.56	length 56 mm; thread 16	2
3.504.58	length 58 mm; thread 16	2
3.504.60	length 60 mm; thread 16	2
3.504.62	length 62 mm; thread 17	2
3.504.64	length 64 mm; thread 17	2
3.504.66	length 66 mm; thread 17	2
3.504.68	length 68 mm; thread 17	2
3.504.70	length 70 mm; thread 17	2

Item no.	Item description	Quant.
Implants – screws		
Full thread - Ø 3.5 mm; self drilling; back tapping; self tapping; titanium		
3.604.10	length 10 mm; thread 5	2
3.604.12	length 12 mm; thread 5	2
3.604.14	length 14 mm; thread 5	2
3.604.16	length 16 mm; thread 6	2
3.604.18	length 18 mm; thread 7	2
3.604.20	length 20 mm; thread 8	2
3.604.22	length 22 mm; thread 9	2
3.604.24	length 24 mm; thread 10	2
3.604.26	length 26 mm; thread 12	2
3.604.28	length 28 mm; thread 14	2
3.604.30	length 30 mm; thread 14	2
3.604.32	length 32 mm; thread 14	2
3.604.34	length 34 mm; thread 14	2
3.604.36	length 36 mm; thread 14	2
3.604.38	length 38 mm; thread 14	2
3.604.40	length 40 mm; thread 14	2
3.604.42	length 42 mm; thread 15	2
3.604.44	length 44 mm; thread 15	2
3.604.46	length 46 mm; thread 15	2
3.604.48	length 48 mm; thread 15	2
3.604.50	length 50 mm; thread 15	2
3.604.52	length 52 mm; thread 16	2
3.604.54	length 54 mm; thread 16	2
3.604.56	length 56 mm; thread 16	2
3.604.58	length 58 mm; thread 16	2
3.604.60	length 60 mm; thread 16	2
3.604.62	length 62 mm; thread 17	2
3.604.64	length 64 mm; thread 17	2
3.604.66	length 66 mm; thread 17	2
3.604.68	length 68 mm; thread 17	2
3.604.70	length 70 mm; thread 17	2

Set Cannulated screws 3.5 st sd

self tapping; self drilling; titanium; Set no. 19.184.00

Item no.	Item description	Quant.
Instruments		
2.950.150	gauge for cannulated screws Ø2.7 to Ø4.0,length 150	1
10.306.06	T-handle with quick coupling,length 93.5,cannulated,inside Ø2.5	1
10.935.00	percutaneous drill bush system for cannulated screws Ø3.5	1
20.502.01	holding clamp,small	1
2.905.27	drill bit f.quick coupling,Ø2.7x160,spiral ln 30,quadr.spiral,cann.,inside Ø1.35	1
2.905.35	drill bit f.quick coupling,Ø3.5x160,spiral ln 30,quadr.spiral,cann.,inside Ø1.35	1
2.907.35	countersink,Ø5x160,cannulated,inside Ø1.3,for cannulated screws Ø3.5	1
2.923.35	tap for quick coupling,Ø3.5x160,cannulated,inside Ø1.5	1
2.9436.25	hex screwdriver with handle for Ø2.7-4;cannulated;lØ1.3;wrench size 2.5;l 215mm	1
2.954.01	screw forceps,self holding	1
2.954.27A	holding sleeve for screws Ø2.7 to Ø3.5	1
2.955.12	cleaning wire Ø1.2 for cannulated instruments	1

Item no.	Item description	Quant.
Wires		
2.978.12	guide wire,Ø1.2x150,thread 5,st.st.	5

Implants - washers		
3.200.02	washer,outside Ø7 / inside Ø3,8,ti	5

Container		
19.185.00	perforated autoclavable container w.inset for instruments/cannul.screws Ø3.5 sd	1

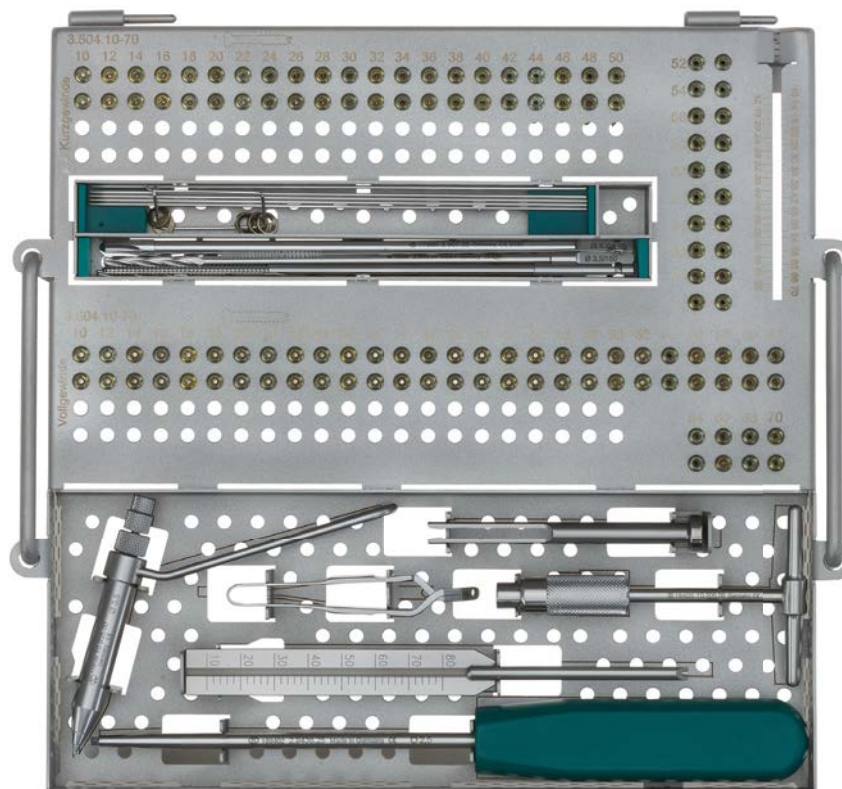

Set no. 19.184.00  Internal hexagon

Set Cannulated screws 4.0 st sd

self tapping; self drilling; Titanium; TiOB®; Set no. 19.190.00



Item no. 3.440.70



Item no. 3.445.70

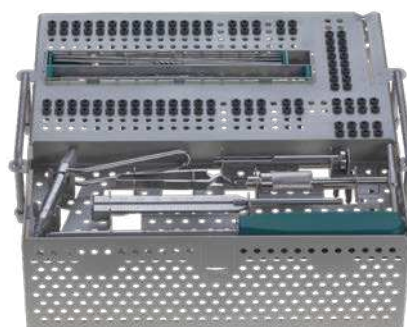

Set no. 19.190.00  Internal hexagon

Item no.	Item description	Quant.
Implants – screws		
Partial thread - Ø 4.0 mm; self drilling; self tapping; back tapping; titanium; TiOB®		
3.440.10	length 10 mm; thread 5	2
3.440.12	length 12 mm; thread 5	2
3.440.14	length 14 mm; thread 5	2
3.440.16	length 16 mm; thread 6	2
3.440.18	length 18 mm; thread 7	2
3.440.20	length 20 mm; thread 8	2
3.440.22	length 22 mm; thread 9	2
3.440.24	length 24 mm; thread 10	2
3.440.26	length 26 mm; thread 12	2
3.440.28	length 28 mm; thread 14	2
3.440.30	length 30 mm; thread 14	2
3.440.32	length 32 mm; thread 14	2
3.440.34	length 34 mm; thread 14	2
3.440.35	length 35 mm; thread 14	2
3.440.36	length 36 mm; thread 14	2
3.440.38	length 38 mm; thread 14	2
3.440.40	length 40 mm; thread 14	2
3.440.42	length 42 mm; thread 15	2
3.440.44	length 44 mm; thread 15	2
3.440.45	length 45 mm; thread 15	2
3.440.46	length 46 mm; thread 15	2
3.440.48	length 48 mm; thread 15	2
3.440.50	length 50 mm; thread 15	2
3.440.55	length 55 mm; thread 16	2
3.440.60	length 60 mm; thread 16	2
3.440.65	length 65 mm; thread 17	2
3.440.70	length 70 mm; thread 17	2

Item no.	Item description	Quant.
Implants – screws		
Full thread - Ø 4.0 mm; self drilling; self tapping; titanium; TiOB®		
3.445.10	length 10 mm	2
3.445.12	length 12 mm	2
3.445.14	length 14 mm	2
3.445.16	length 16 mm	2
3.445.18	length 18 mm	2
3.445.20	length 20 mm	2
3.445.22	length 22 mm	2
3.445.24	length 24 mm	2
3.445.26	length 26 mm	2
3.445.28	length 28 mm	2
3.445.30	length 30 mm	2
3.445.32	length 32 mm	2
3.445.34	length 34 mm	2
3.445.35	length 35mm	2
3.445.36	length 36 mm	2
3.445.38	length 38 mm	2
3.445.40	length 40 mm	2
3.445.42	length 42 mm	2
3.445.44	length 44 mm	2
3.445.45	length 45 mm	2
3.445.46	length 46 mm	2
3.445.48	length 48 mm	2
3.445.50	length 50 mm	2
3.445.55	length 55 mm	2
3.445.60	length 60 mm	2
3.445.65	length 65 mm	2
3.445.70	length 70 mm	2

Set Cannulated screws 4.0 st sd

self tapping; self drilling; Titanium; TiOB®; Set no. 19.190.00

Item no.	Item description	Quant.
Instruments		
2.950.150	gauge for cannulated screws Ø2.7 to Ø4.0,length 150	1
10.306.06	T-handle with quick coupling,length 93.5,cannulated,inside Ø2.5	1
10.940.00	percutaneous drill bush system for cannulated screws Ø4	1
20.502.01	holding clamp,small	1
2.906.40	pilot drill bit f.quick coupling,Ø3x100,bore length 60,cannulated,inside Ø1.8	1
2.907.40	countersink,Ø6x160,cannulated,inside Ø1.8,for cannulated screws Ø4	1
2.9436.40	hex screwdriver with handle for Ø2.7-4;cannulated;lØ1.7;wrench size 2.5;L 215mm	1
2.954.01	screw forceps,self holding	1
2.954.35A	holding sleeve for screws Ø3.5 and Ø4.0	1
2.955.16	cleaning wire Ø1.6 for cannulated instruments	1

Item no.	Item description	Quant.
Wires		
2.978.16	guide wire,Ø1.6x150,thread 5,st.st.	5

Implants - washers		
3.200.40	washer,outside Ø10 / inside Ø5,ti	5

Container		
19.191.00	perforated autoclavable container with inset for instruments/cannul.screws Ø4	1

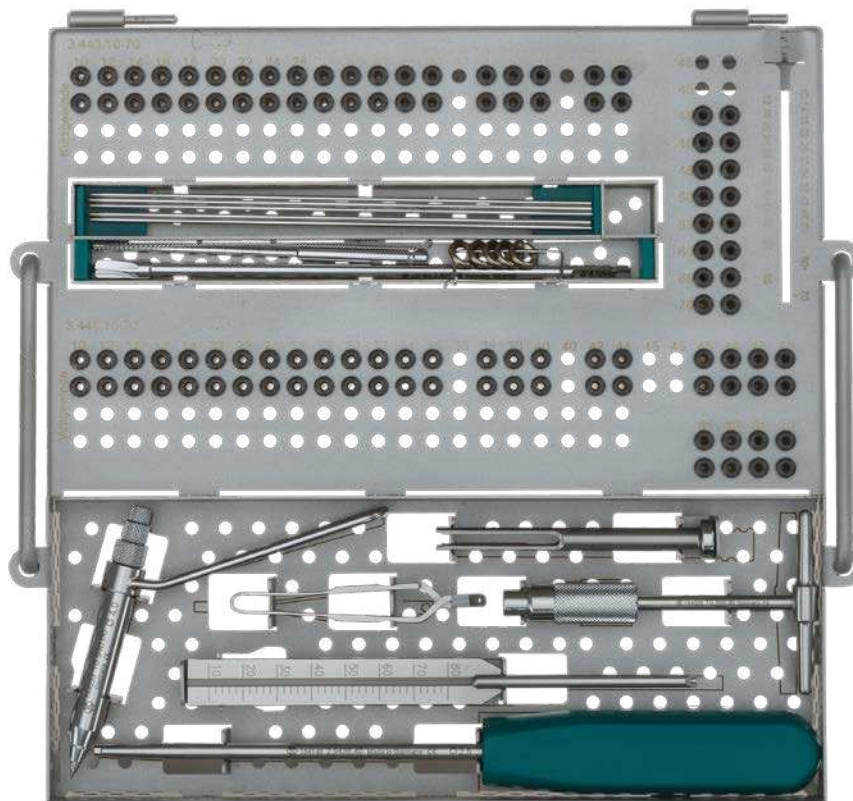

Set no. 19.190.00  Internal hexagon

Information

TiOB® is a trademark of Königsee Implantate GmbH registered in the EU countries, Switzerland and the USA. It is a surface treatment that brings optimized properties.



Königsee Implantate GmbH
OT Aschau | Am Sand 4
07426 Allendorf | Germany

Fon +49 36738 498-560
Fax +49 36738 498-569

Mail export@koenigsee-implantate.de

For further information please visit:
www.koenigsee-implantate.com

AnSp | Edition 04 | 2020-08
All pictured products are CE compliant.

Set Cannulated screws 4.5 st

self tapping; Titanium; Set no. 19.200.00



Item no. 3.430.30



Item no. 3.435.30

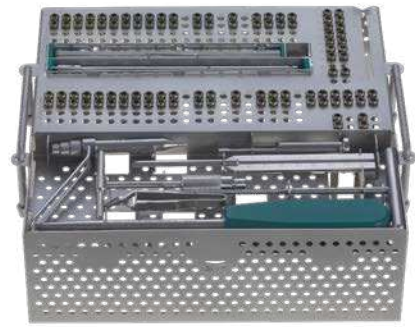

Set no. 19.200.00  Internal hexagon

Item no.	Item description	Quant.
Implants – screws		
Partial thread - Ø 4.5 mm; self tapping; titanium		
3.430.20	length 20 mm; thread 7	2
3.430.22	length 22 mm; thread 7	2
3.430.24	length 24 mm; thread 8	2
3.430.26	length 26 mm; thread 9	2
3.430.28	length 28 mm; thread 9	2
3.430.30	length 20 mm; thread 10	2
3.430.32	length 32 mm; thread 11	2
3.430.34	length 34 mm; thread 11	2
3.430.36	length 36 mm; thread 12	2
3.430.38	length 38 mm; thread 13	2
3.430.40	length 40 mm; thread 13	2
3.430.42	length 42 mm; thread 14	2
3.430.44	length 44 mm; thread 15	2
3.430.46	length 46 mm; thread 15	2
3.430.48	length 48 mm; thread 16	2
3.430.50	length 50 mm; thread 16	2
3.430.52	length 52 mm; thread 17	2
3.430.54	length 54 mm; thread 19	2
3.430.56	length 56 mm; thread 19	2
3.430.58	length 58 mm; thread 20	2
3.430.60	length 60 mm; thread 20	2
3.430.62	length 62 mm; thread 21	2
3.430.64	length 64 mm; thread 21	2
3.430.66	length 66 mm; thread 22	2
3.430.68	length 68 mm; thread 23	2
3.430.72	length 72 mm; thread 24	2

Item no.	Item description	Quant.
Implants – screws		
Full thread - Ø 4.5 mm; self tapping; titanium		
3.435.20	length 20 mm	2
3.435.22	length 22 mm	2
3.435.24	length 24 mm	2
3.435.26	length 26 mm	2
3.435.28	length 28 mm	2
3.435.30	length 30 mm	2
3.435.32	length 32 mm	2
3.435.34	length 34 mm	2
3.435.36	length 36 mm	2
3.435.38	length 38 mm	2
3.435.40	length 40 mm	2
3.435.42	length 42 mm	2
3.435.44	length 44 mm	2
3.435.46	length 46mm	2
3.435.48	length 48 mm	2
3.435.50	length 50 mm	2
3.435.52	length 52 mm	2
3.435.54	length 54 mm	2
3.435.56	length 56 mm	2
3.435.58	length 58 mm	2
3.435.60	length 60 mm	2
3.435.62	length 62 mm	2
3.435.64	length 64 mm	2
3.435.66	length 66 mm	2
3.435.68	length 68 mm	2
3.435.72	length 72 mm	2

Set Cannulated screws 4.5 st

self tapping; Titanium; Set no. 19.200.00

Item no.	Item description	Quant.
Instruments		
2.951.150	gauge for cannulated screws Ø4.5,length 150	1
10.306.06	T-handle with quick coupling,length 93.5,cannulated,inside Ø2.5	1
10.945.00	percutaneous drill bush system for cannulated screws Ø4.5	1
20.502.01	holding clamp,small	1
2.905.32	drill bit f.quick coupling,Ø3.2x160,spiral ln 60,quadr.spiral,cann.,inside Ø1.75	1
2.905.45	drill bit f.quick coupling,Ø4.5x160,spiral ln 60,quadr.spiral,cann.,inside Ø1.8	1
2.907.45	countersink,Ø6.5x160,cannulated,inside Ø1.75,for cannulated screws Ø4.5	1
2.923.45	tap with T-handle,Ø4.5x135,cannulated,inside Ø1.75	1
2.9436.35	hex screwdriver with handle for Ø4.5-7;cannulated;lØ2.2;wrench size 3.5;L 215mm	1
2.954.01	screw forceps,self holding	1
2.954.45A	holding sleeve for screws Ø4.5	1
2.955.16	cleaning wire Ø1.6 for cannulated instruments	1

Item no.	Item description	Quant.
Wires		
2.978.16	guide wire,Ø1.6x150,thread 5,st.st.	5

Implants - washers		
3.200.40	washer,outside Ø10 / inside Ø5,ti	5

Container		
19.201.00	perforated autoclavable container with inset for instruments/cannul.screws Ø4.5	1

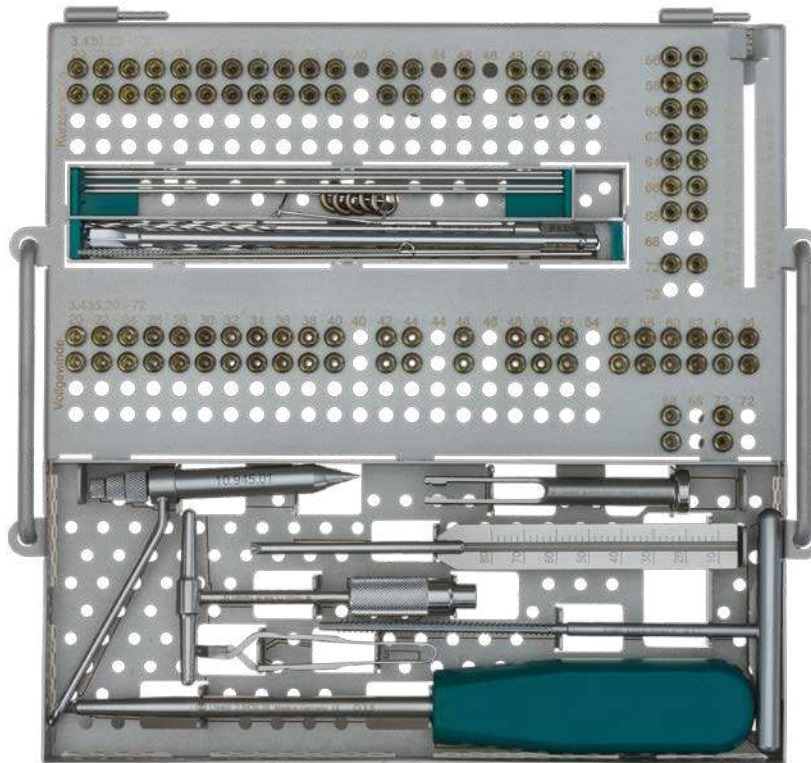

Set no. 19.200.00



Internal hexagon

Set Cannulated screw 4.5 st sd

self tapping; self drilling; Titanium; Set no. 19.203.00



Item no. 3.434.30



Item no. 3.439.30

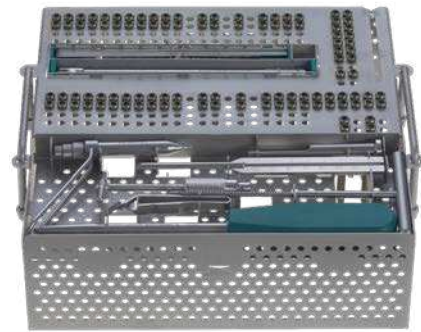

Set no. 19.203.00  Internal hexagon

Item no.	Item description	Quant.
Implants – screws		
Partial thread - Ø 4.5 mm; self drilling; back tapping; self tapping; titanium		
3.434.20	length 20 mm; thread 7	2
3.434.22	length 22 mm; thread 7	2
3.434.24	length 24 mm; thread 8	2
3.434.26	length 26 mm; thread 9	2
3.434.28	length 28 mm; thread 9	2
3.434.30	length 20 mm; thread 10	2
3.434.32	length 32 mm; thread 11	2
3.434.34	length 34 mm; thread 11	2
3.434.36	length 36 mm; thread 12	2
3.434.38	length 38 mm; thread 13	2
3.434.40	length 40 mm; thread 13	2
3.434.42	length 42 mm; thread 14	2
3.434.44	length 44 mm; thread 15	2
3.434.46	length 46 mm; thread 15	2
3.434.48	length 48 mm; thread 16	2
3.434.50	length 50 mm; thread 16	2
3.434.52	length 52 mm; thread 17	2
3.434.54	length 54 mm; thread 19	2
3.434.56	length 56 mm; thread 19	2
3.434.58	length 58 mm; thread 20	2
3.434.60	length 60 mm; thread 20	2
3.434.62	length 62 mm; thread 21	2
3.434.64	length 64 mm; thread 21	2
3.434.66	length 66 mm; thread 22	2
3.434.68	length 68 mm; thread 23	2
3.434.72	length 72 mm; thread 24	2

Item no.	Item description	Quant.
Implants – screws		
Full thread - Ø 4.5 mm; self drilling; self tapping; titanium		
3.439.20	length 20 mm	2
3.439.22	length 22 mm	2
3.439.24	length 24 mm	2
3.439.26	length 26 mm	2
3.439.28	length 28 mm	2
3.439.30	length 30 mm	2
3.439.32	length 32 mm	2
3.439.34	length 34 mm	2
3.439.36	length 36 mm	2
3.439.38	length 38 mm	2
3.439.40	length 40 mm	2
3.439.42	length 42 mm	2
3.439.44	length 44 mm	2
3.439.46	length 46mm	2
3.439.48	length 48 mm	2
3.439.50	length 50 mm	2
3.439.52	length 52 mm	2
3.439.54	length 54 mm	2
3.439.56	length 56 mm	2
3.439.58	length 58 mm	2
3.439.60	length 60 mm	2
3.439.62	length 62 mm	2
3.439.64	length 64 mm	2
3.439.66	length 66 mm	2
3.439.68	length 68 mm	2
3.439.72	length 72 mm	2

Set Cannulated screw 4.5 st sd

self tapping; self drilling; Titanium; Set no. 19.203.00

Item no.	Item description	Quant.
Instruments		
2.951.150	gauge for cannulated screws Ø4.5,length 150	1
10.306.06	T-handle with quick coupling,length 93.5,cannulated,inside Ø2.5	1
10.945.00	percutaneous drill bush system for cannulated screws Ø4.5	1
20.502.01	holding clamp,small	1
2.905.32	drill bit f.quick coupling,Ø3.2x160,spiral ln 60,quadr.spiral,cann.,inside Ø1.75	1
2.905.45	drill bit f.quick coupling,Ø4.5x160,spiral ln 60,quadr.spiral,cann.,inside Ø1.8	1
2.907.45	countersink,Ø6.5x160,cannulated,inside Ø1.75,for cannulated screws Ø4.5	1
2.923.45	tap with T-handle,Ø4.5x135,cannulated,inside Ø1.75	1
2.9436.35	hex screwdriver with handle for Ø4.5-7;cannulated;lØ2.2;wrench size 3.5;L 215mm	1
2.954.01	screw forceps,self holding	1
2.954.45A	holding sleeve for screws Ø4.5	1
2.955.16	cleaning wire Ø1.6 for cannulated instruments	1

Item no.	Item description	Quant.
Wires		
2.978.16	guide wire,Ø1.6x150,thread 5,st.st.	5

Implants - washers		
3.200.40	washer,outside Ø10 / inside Ø5,ti	5

Container		
19.205.00	perforated autoclavable container with inset for instruments/cannul.screws Ø4.5	1

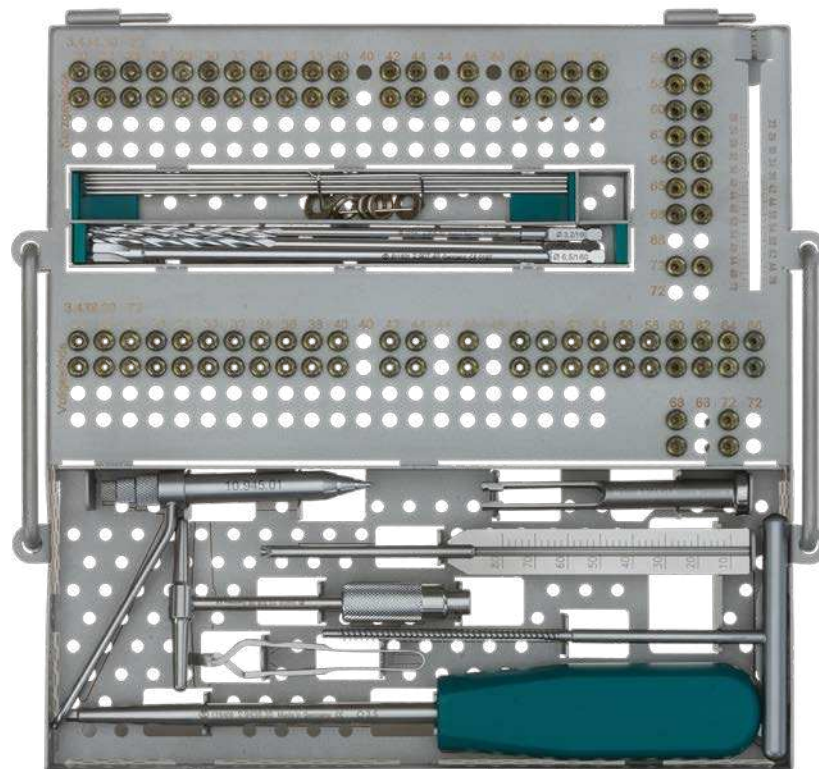

Set no. 19.203.00  Internal hexagon

Set Cannulated screws 6.5 st sd

self tapping; self drilling; Titanium; TiOB®; Set no. 19.210.00



Item no. 3.520.70



Item no. 3.523.70

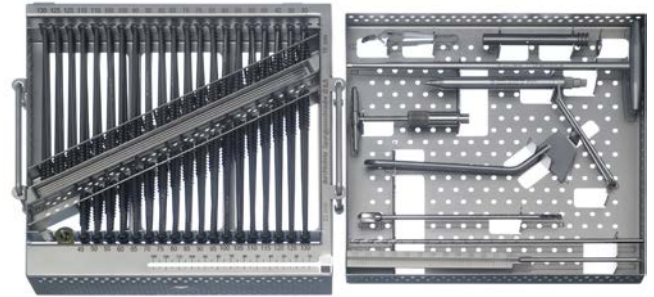

Set no. 19.210.00  Internal hexagon

Item no.	Item description	Quant.
Implants – screws		
Partial thread 16 - Ø 6.5 mm; self drilling; back tapping; self tapping; titanium; TiOB®		
3.520.30	length 30 mm	2
3.520.35	length 35 mm	2
3.520.40	length 40 mm	2
3.520.45	length 45 mm	2
3.520.50	length 50 mm	2
3.520.55	length 55 mm	2
3.520.60	length 60 mm	2
3.520.65	length 65 mm	2
3.520.70	length 70 mm	2
3.520.75	length 75 mm	2
3.520.80	length 80 mm	2
3.520.85	length 85 mm	2
3.520.90	length 90 mm	2
3.520.95	length 95 mm	2
3.520.100	length 100 mm	2
3.520.105	length 105 mm	2
3.520.110	length 110 mm	2
3.520.115	length 115 mm	2
3.520.120	length 120 mm	2
3.520.125	length 125 mm	2
3.520.130	length 130 mm	2

Item no.	Item description	Quant.
Implants – screws		
Partial thread 32 - Ø 6.5 mm; self drilling; back tapping; self tapping; titanium; TiOB®		
3.523.45	length 45 mm	2
3.523.50	length 50 mm	2
3.523.55	length 55 mm	2
3.523.60	length 60 mm	2
3.523.65	length 65 mm	2
3.523.70	length 70 mm	2
3.523.75	length 75 mm	2
3.523.80	length 80 mm	2
3.523.85	length 85 mm	2
3.523.90	length 90 mm	2
3.523.95	length 95 mm	2
3.523.100	length 100 mm	2
3.523.105	length 105 mm	2
3.523.110	length 110 mm	2
3.523.115	length 115 mm	2
3.523.120	length 120 mm	2
3.523.125	length 125 mm	2
3.523.130	length 130 mm	2

Set Cannulated screws 6.5 st sd

self tapping; self drilling; Titanium; TiOB®; Set no. 19.210.00

Item no.	Item description	Quant.
Instruments		
2.952.230	gauge for cannulated screws Ø6,5 and Ø7,0,length 230	1
10.306.06	T-handle with quick coupling,length 93.5,cannulated,inside Ø2.5	1
10.965.00	percutaneous drill bush system for cannulated screws Ø6.5	1
2.907.70	countersink,Ø8x160,cutter ln 19.5,cannulated,inside Ø2.1,for cannul.screws Ø6.5	1
2.908.40	drill bit w.triangular shank,Ø4x230,spiral ln 40,cann.,inside Ø2.1,triple sp.	1
2.942.02	hex screwdriver with T-handle for screw Ø4.5 until Ø7.0,cannulated,inside Ø2.2	1
2.954.01	screw forceps,self holding	1
2.954.65A	holding sleeve for screws Ø6.5 and Ø7,0	1
2.955.20	cleaning wire Ø2 for cannulated instruments	1
2.960.03	parallel targeting device for guide wire Ø2	1

Item no.	Item description	Quant.
Wires		
2.979.20	guide wire,Ø2x230,thread 5,st.st.	5

Implants - washers		
3.200.04	washer,outside Ø16 / inside Ø6.7,ti	5

Container		
19.000.10	sterilizing container,290x290x100,colour silver	1
19.211.00	perforated autoclavable container with inset for instruments/cannul.screws Ø6.5	1

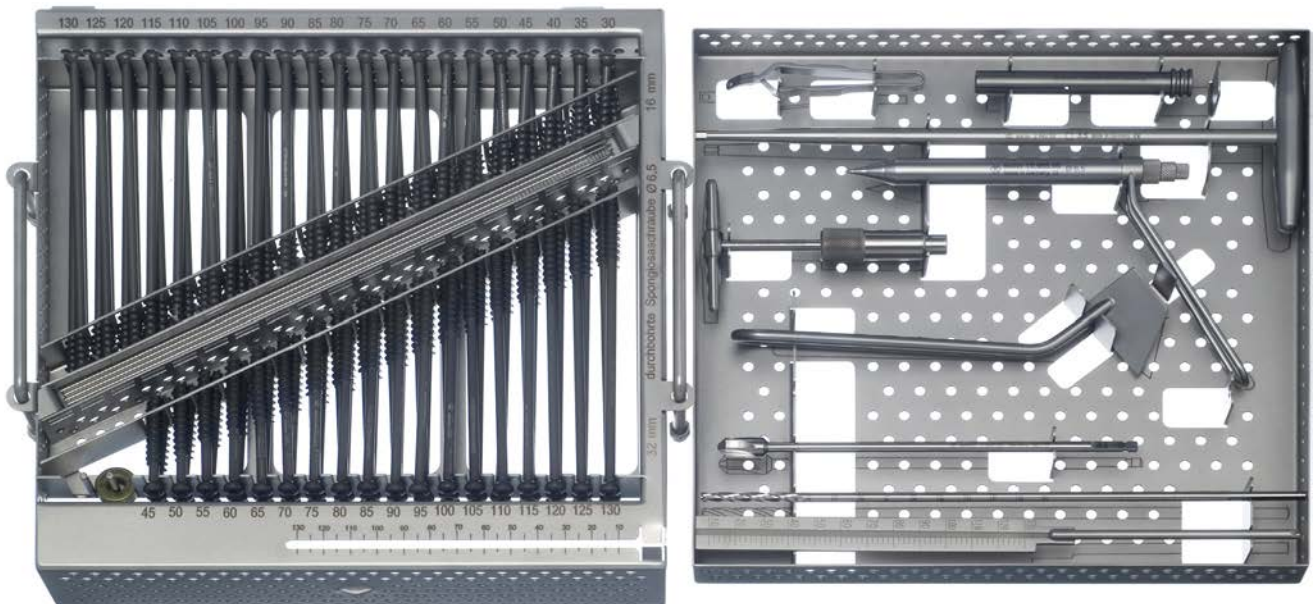

Set no. 19.210.00  Internal hexagon

Information

TiOB® is a trademark of Königsee Implantate GmbH registered in the EU countries, Switzerland and the USA. It is a surface treatment that brings optimized properties.



Königsee Implantate GmbH
OT Aschau | Am Sand 4
07426 Allendorf | Germany

Fon +49 36738 498-560
Fax +49 36738 498-569

Mail export@koenigsee-implantate.de

For further information please visit:
www.koenigsee-implantate.com

AnSp | Edition 04 | 2020-08
All pictured products are CE compliant.

Set Cannulated screws 7.0 st sd

self tapping; self drilling; Titanium; Set no.19.223.00



Item no. 3.414.70



Item no. 3.424.70

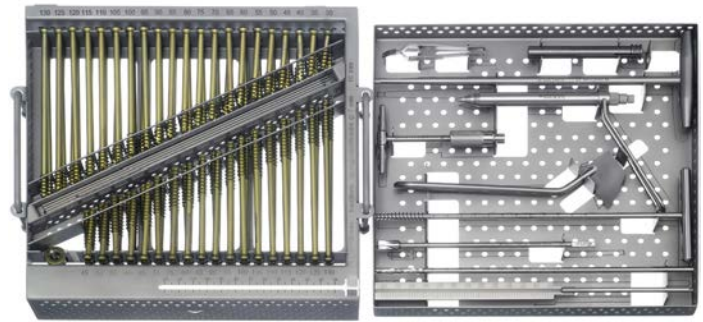

Set no. 19.223.00  Internal hexagon

Item no.	Item description	Quant.
Implants – screws		
Partial thread 16 - Ø 7.0 mm; self drilling; back tapping; self tapping; titanium		
3.414.30	length 30 mm	2
3.414.35	length 35 mm	2
3.414.40	length 40 mm	2
3.414.45	length 45 mm	2
3.414.50	length 50 mm	2
3.414.55	length 55 mm	2
3.414.60	length 60 mm	2
3.414.65	length 65 mm	2
3.414.70	length 70 mm	2
3.414.75	length 75 mm	2
3.414.80	length 80 mm	2
3.414.85	length 85 mm	2
3.414.90	length 90 mm	2
3.414.95	length 95 mm	2
3.414.100	length 100 mm	2
3.414.105	length 105 mm	2
3.414.110	length 110 mm	2
3.414.115	length 115 mm	2
3.414.120	length 120 mm	2
3.414.125	length 125 mm	2
3.414.130	length 130 mm	2

Item no.	Item description	Quant.
Implants – screws		
Partial thread 32 - Ø 7.0 mm; self drilling; back tapping; self tapping; titanium		
3.424.45	length 45 mm	2
3.424.50	length 50 mm	2
3.424.55	length 55 mm	2
3.424.60	length 60 mm	2
3.424.65	length 65 mm	2
3.424.70	length 70 mm	2
3.424.75	length 75 mm	2
3.424.80	length 80 mm	2
3.424.85	length 85 mm	2
3.424.90	length 90 mm	2
3.424.95	length 95 mm	2
3.424.100	length 100 mm	2
3.424.105	length 105 mm	2
3.424.110	length 110 mm	2
3.424.115	length 115 mm	2
3.424.120	length 120 mm	2
3.424.125	length 125 mm	2
3.424.130	length 130 mm	2

Set Cannulated screws 7.0 st sd

self tapping; self drilling; Titanium; Set no.19.223.00

Item no.	Item description	Quant.
Instruments		
2.952.230	gauge for cannulated screws Ø6,5 and Ø7,0,length 230	1
10.306.06	T-handle with quick coupling,length 93.5,cannulated,inside Ø2.5	1
10.970.00	percutaneous drill bush system for cannulated screws Ø7.0	1
2.907.70	countersink,Ø8x160,cutter ln 19.5,cannulated,inside Ø2.1,for cannul.screws Ø6.5	1
2.908.45	drill bit w.triangular shank,Ø4.5x230,spiral ln 40,cann.,inside Ø2.1,triple sp	1
2.922.07	tap with T-handle,Ø7x230,cannulated,inside Ø2.3,extra long	1
2.942.02	hex screwdriver with T-handle for screw Ø4.5 until Ø7.0,cannulated,inside Ø2.2	1
2.954.01	screw forceps,self holding	1
2.954.65A	holding sleeve for screws Ø6.5 and Ø7,0	1
2.955.20	cleaning wire Ø2 for cannulated instruments	1
2.960.03	parallel targeting device for guide wire Ø2	1

Item no.	Item description	Quant.
Wires		
2.979.20	guide wire,Ø2x230,thread 5,st.st.	5

Implants - washers		
3.200.04	washer,outside Ø16 / inside Ø6.7,ti	5

Container		
19.000.10	sterilizing container,290x290x100,colour silver	1
19.224.00	perforated autoclavable container with inset for instruments/cannul.screws Ø7.0	1

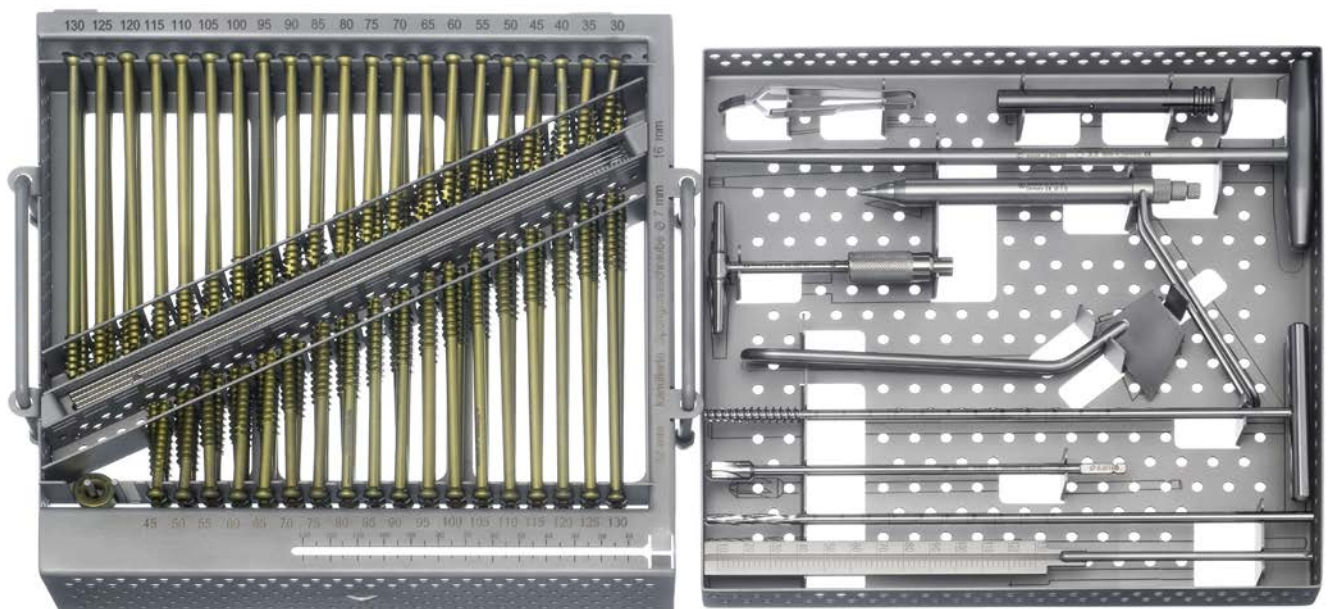

Set no. 19.223.00  Internal hexagon

Cannulated screws

stainless steel



Item no. 2.409.75



Item no. 2.412.75



Item no. 2.414.75



Item no. 2.422.70



Item no. 2.424.75



Item no. 2.430.60



Item no. 2.434.72



Item no. 2.435.72

Item no.	Item description	EAN
----------	------------------	-----

Cannulated screw 3.5 partial thread st

2.502.10	Ø 3.5 x 10 mm; thread 5; self tapping; stainless steel	4 047075 080304
2.502.12	Ø 3.5 x 12 mm; thread 5; self tapping; stainless steel	4 047075 080427
2.502.14	Ø 3.5 x 14 mm; thread 5; self tapping; stainless steel	4 047075 080595
2.502.16	Ø 3.5 x 16 mm; thread 6; self tapping; stainless steel	4 047075 080489
2.502.18	Ø 3.5 x 18 mm; thread 7; self tapping; stainless steel	4 047075 080496
2.502.22	Ø 3.5 x 22 mm; thread 9; self tapping; stainless steel	4 047075 080410
2.502.24	Ø 3.5 x 24 mm; thread 10; self tapping; stainless steel	4 047075 080533
2.502.26	Ø 3.5 x 26 mm; thread 12; self tapping; stainless steel	4 047075 080434
2.502.35	Ø 3.5 x 35 mm; thread 14; self tapping; stainless steel	4 047075 080540
2.502.36	Ø 3.5 x 36 mm; thread 14; self tapping; stainless steel	4 047075 080557
2.502.38	Ø 3.5 x 38 mm; thread 14; self tapping; stainless steel	4 047075 080458
2.502.45	Ø 3.5 x 45 mm; thread 15; self tapping; stainless steel	4 047075 080663
2.502.52	Ø 3.5 x 52 mm; thread 16; self tapping; stainless steel	4 047075 080717
2.502.54	Ø 3.5 x 54 mm; thread 16; self tapping; stainless steel	4 047075 080601
2.502.56	Ø 3.5 x 56 mm; thread 16; self tapping; stainless steel	4 047075 080625
2.502.58	Ø 3.5 x 58 mm; thread 16; self tapping; stainless steel	4 047075 080502
2.502.60	Ø 3.5 x 60 mm; thread 16; self tapping; stainless steel	4 047075 080687
2.502.62	Ø 3.5 x 62 mm; thread 17; self tapping; stainless steel	4 047075 080694
2.502.64	Ø 3.5 x 64 mm; thread 17; self tapping; stainless steel	4 047075 080700
2.502.65	Ø 3.5 x 65 mm; thread 17; self tapping; stainless steel	4 047075 080830
2.502.66	Ø 3.5 x 66 mm; thread 17; self tapping; stainless steel	4 047075 080847
2.502.68	Ø 3.5 x 68 mm; thread 17; self tapping; stainless steel	4 047075 080854
2.502.70	Ø 3.5 x 70 mm; thread 17; self tapping; stainless steel	4 047075 080861

Cannulated screw 3.5 partial thread st bt sd

2.504.10	Ø 3.5 x 10 mm; thread 5; self drilling; back tapping; self tapping; stainless steel	4 047075 001439
2.504.12	Ø 3.5 x 12 mm; thread 5; self drilling; back tapping; self tapping; stainless steel	4 047075 001446



Königsee Implantate GmbH
OT Aschau | Am Sand 4
07426 Allendorf | Germany

Fon +49 36738 498-560
Fax +49 36738 498-569

Mail export@koenigsee-implantate.de

For further information please visit:
www.koenigsee-implantate.com

KrMo | Edition 04 | 2020-04
All pictured products are CE compliant.

Cannulated screws

stainless steel



Item no. 2.502.68



Item no. 2.504.66



Item no. 2.602.64



Item no. 2.604.62



Item no. 2.520.80



Item no. 2.523.80



Item no. 2.525.70

Item no.	Item description	EAN
2.504.14	Ø 3.5 x 14 mm; thread 5; self drilling; back tapping; self tapping; stainless steel	4 047075 001453
2.504.16	Ø 3.5 x 16 mm; thread 6; self drilling; back tapping; self tapping; stainless steel	4 047075 001460
2.504.18	Ø 3.5 x 18 mm; thread 7; self drilling; back tapping; self tapping; stainless steel	4 047075 001477
2.504.20	Ø 3.5 x 20 mm; thread 8; self drilling; back tapping; self tapping; stainless steel	4 047075 001484
2.504.22	Ø 3.5 x 22 mm; thread 9; self drilling; back tapping; self tapping; stainless steel	4 047075 001491
2.504.24	Ø 3.5 x 24 mm; thread 10; self drilling; back tapping; self tapping; stainless steel	4 047075 001507
2.504.26	Ø 3.5 x 26 mm; thread 12; self drilling; back tapping; self tapping; stainless steel	4 047075 001514
2.504.28	Ø 3.5 x 28 mm; thread 14; self drilling; back tapping; self tapping; stainless steel	4 047075 001521
2.504.30	Ø 3.5 x 30 mm; thread 14; self drilling; back tapping; self tapping; stainless steel	4 047075 001538
2.504.35	Ø 3.5 x 35 mm; thread 14; self drilling; back tapping; self tapping; stainless steel	4 047075 001569
2.504.38	Ø 3.5 x 38 mm; thread 14; self drilling; back tapping; self tapping; stainless steel	4 047075 001583
2.504.40	Ø 3.5 x 40 mm; thread 14; self drilling; back tapping; self tapping; stainless steel	4 047075 001590
2.504.42	Ø 3.5 x 42 mm; thread 15; self drilling; back tapping; self tapping; stainless steel	4 047075 001606
2.504.44	Ø 3.5 x 44 mm; thread 15; self drilling; back tapping; self tapping; stainless steel	4 047075 001613
2.504.45	Ø 3.5 x 45 mm; thread 15; self drilling; back tapping; self tapping; stainless steel	4 047075 001620
2.504.46	Ø 3.5 x 46 mm; thread 15; self drilling; back tapping; self tapping; stainless steel	4 047075 001637
2.504.48	Ø 3.5 x 48 mm; thread 15; self drilling; back tapping; self tapping; stainless steel	4 047075 001644
2.504.50	Ø 3.5 x 50 mm; thread 15; self drilling; back tapping; self tapping; stainless steel	4 047075 001651
2.504.52	Ø 3.5 x 52 mm; thread 16; self drilling; back tapping; self tapping; stainless steel	4 047075 001255
2.504.54	Ø 3.5 x 54 mm; thread 16; self drilling; back tapping; self tapping; stainless steel	4 047075 001262
2.504.55	Ø 3.5 x 55 mm; thread 16; self drilling; back tapping; self tapping; stainless steel	4 047075 001279
2.504.56	Ø 3.5 x 56 mm; thread 16; self drilling; back tapping; self tapping; stainless steel	4 047075 001286
2.504.58	Ø 3.5 x 58 mm; thread 16; self drilling; back tapping; self tapping; stainless steel	4 047075 001293
2.504.60	Ø 3.5 x 60 mm; thread 16; self drilling; back tapping; self tapping; stainless steel	4 047075 001309
2.504.62	Ø 3.5 x 62 mm; thread 17; self drilling; back tapping; self tapping; stainless steel	4 047075 001316
2.504.64	Ø 3.5 x 64 mm; thread 17; self drilling; back tapping; self tapping; stainless steel	4 047075 001323
2.504.65	Ø 3.5 x 65 mm; thread 17; self drilling; back tapping; self tapping; stainless steel	4 047075 001330

Cannulated screws

titanium

Item no.	Item description	EAN
3.450.48	Ø 2.7 x 48 mm; fully threaded; self drilling; self tapping; titanium	 4 047075 098880
3.450.50	Ø 2.7 x 50 mm; fully threaded; self drilling; self tapping; titanium	 4 047075 098804
3.450.55	Ø 2.7 x 55 mm; fully threaded; self drilling; self tapping; titanium	 4 047075 098990
3.450.60	Ø 2.7 x 60 mm; fully threaded; self drilling; self tapping; titanium	 4 047075 098828
3.450.65	Ø 2.7 x 65 mm; fully threaded; self drilling; self tapping; titanium	 4 047075 058938
3.450.70	Ø 2.7 x 70 mm; fully threaded; self drilling; self tapping; titanium	 4 047075 058945
3.450.75	Ø 2.7 x 75 mm; fully threaded; self drilling; self tapping; titanium	 4 047075 058952
3.450.80	Ø 2.7 x 80 mm; fully threaded; self drilling; self tapping; titanium	 4 047075 058969
Cannulated screw 3.5 partial thread st		
3.502.10	Ø 3.5 x 10 mm; thread 5; self tapping; titanium	 4 047075 099610
3.502.12	Ø 3.5 x 12 mm; thread 5; self tapping; titanium	 4 047075 099498
3.502.14	Ø 3.5 x 14 mm; thread 5; self tapping; titanium	 4 047075 099504
3.502.16	Ø 3.5 x 16 mm; thread 6; self tapping; titanium	 4 047075 099511
3.502.18	Ø 3.5 x 18 mm; thread 7; self tapping; titanium	 4 047075 099696
3.502.20	Ø 3.5 x 20 mm; thread 8; self tapping; titanium	 4 047075 099702
3.502.22	Ø 3.5 x 22 mm; thread 9; self tapping; titanium	 4 047075 099719
3.502.24	Ø 3.5 x 24 mm; thread 10; self tapping; titanium	 4 047075 099627
3.502.26	Ø 3.5 x 26 mm; thread 12; self tapping; titanium	 4 047075 099733
3.502.28	Ø 3.5 x 28 mm; thread 14; self tapping; titanium	 4 047075 099634
3.502.30	Ø 3.5 x 30 mm; thread 14; self tapping; titanium	 4 047075 099641
3.502.32	Ø 3.5 x 32 mm; thread 14; self tapping; titanium	 4 047075 099658
3.502.34	Ø 3.5 x 34 mm; thread 14; self tapping; titanium	 4 047075 099726
3.502.36	Ø 3.5 x 36 mm; thread 14; self tapping; titanium	 4 047075 099832
3.502.38	Ø 3.5 x 38 mm; thread 14; self tapping; titanium	 4 047075 099740
3.502.40	Ø 3.5 x 40 mm; thread 14; self tapping; titanium	 4 047075 099757
3.502.42	Ø 3.5 x 42 mm; thread 15; self tapping; titanium	 4 047075 099764
3.502.44	Ø 3.5 x 44 mm; thread 15; self tapping; titanium	 4 047075 099665
3.502.46	Ø 3.5 x 46 mm; thread 15; self tapping; titanium	 4 047075 099672
3.502.48	Ø 3.5 x 48 mm; thread 15; self tapping; titanium	 4 047075 099689
3.502.50	Ø 3.5 x 50 mm; thread 15; self tapping; titanium	 4 047075 099856
3.502.52	Ø 3.5 x 52 mm; thread 16; self tapping; titanium	 4 047075 099863
3.502.54	Ø 3.5 x 54 mm; thread 16; self tapping; titanium	 4 047075 099870
3.502.56	Ø 3.5 x 56 mm; thread 16; self tapping; titanium	 4 047075 099771
3.502.58	Ø 3.5 x 58 mm; thread 16; self tapping; titanium	 4 047075 099894



















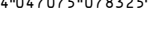





Cannulated screws

stainless steel

Item no.	Item description	EAN
2.604.20	Ø 3.5 x 20 mm; fully threaded; self drilling; self tapping; stainless steel	
2.604.22	Ø 3.5 x 22 mm; fully threaded; self drilling; self tapping; stainless steel	
2.604.24	Ø 3.5 x 24 mm; fully threaded; self drilling; self tapping; stainless steel	
2.604.26	Ø 3.5 x 26 mm; fully threaded; self drilling; self tapping; stainless steel	
2.604.28	Ø 3.5 x 28 mm; fully threaded; self drilling; self tapping; stainless steel	
2.604.30	Ø 3.5 x 30 mm; fully threaded; self drilling; self tapping; stainless steel	
2.604.32	Ø 3.5 x 32 mm; fully threaded; self drilling; self tapping; stainless steel	
2.604.34	Ø 3.5 x 34 mm; fully threaded; self drilling; self tapping; stainless steel	
2.604.36	Ø 3.5 x 36 mm; fully threaded; self drilling; self tapping; stainless steel	
2.604.38	Ø 3.5 x 38 mm; fully threaded; self drilling; self tapping; stainless steel	
2.604.40	Ø 3.5 x 40 mm; fully threaded; self drilling; self tapping; stainless steel	
2.604.42	Ø 3.5 x 42 mm; fully threaded; self drilling; self tapping; stainless steel	
2.604.44	Ø 3.5 x 44 mm; fully threaded; self drilling; self tapping; stainless steel	
2.604.46	Ø 3.5 x 46 mm; fully threaded; self drilling; self tapping; stainless steel	
2.604.48	Ø 3.5 x 48 mm; fully threaded; self drilling; self tapping; stainless steel	
2.604.50	Ø 3.5 x 50 mm; fully threaded; self drilling; self tapping; stainless steel	
2.604.52	Ø 3.5 x 52 mm; fully threaded; self drilling; self tapping; stainless steel	
2.604.54	Ø 3.5 x 54 mm; fully threaded; self drilling; self tapping; stainless steel	
2.604.58	Ø 3.5 x 58 mm; fully threaded; self drilling; self tapping; stainless steel	
2.604.62	Ø 3.5 x 62 mm; fully threaded; self drilling; self tapping; stainless steel	
2.604.64	Ø 3.5 x 64 mm; fully threaded; self drilling; self tapping; stainless steel	
2.604.68	Ø 3.5 x 68 mm; fully threaded; self drilling; self tapping; stainless steel	
Cannulated screw 4.5 partial thread st		
2.430.20	Ø 4.5 x 20 mm; thread 7; self tapping; stainless steel	
2.430.22	Ø 4.5 x 22 mm; thread 7; self tapping; stainless steel	
2.430.24	Ø 4.5 x 24 mm; thread 8; self tapping; stainless steel	
2.430.26	Ø 4.5 x 26 mm; thread 9; self tapping; stainless steel	
2.430.32	Ø 4.5 x 32 mm; thread 11; self tapping; stainless steel	
2.430.34	Ø 4.5 x 34 mm; thread 11; self tapping; stainless steel	
2.430.36	Ø 4.5 x 36 mm; thread 12; self tapping; stainless steel	
2.430.38	Ø 4.5 x 38 mm; thread 13; self tapping; stainless steel	
2.430.40	Ø 4.5 x 40 mm; thread 13; self tapping; stainless steel	
2.430.42	Ø 4.5 x 42 mm; thread 14; self tapping; stainless steel	
2.430.44	Ø 4.5 x 44 mm; thread 15; self tapping; stainless steel	
2.430.45	Ø 4.5 x 45 mm; thread 15; self tapping; stainless steel	

































Cannulated screws

stainless steel

Item no.	Item description	EAN
2.430.46	Ø 4.5 x 46 mm; thread 15; self tapping; stainless steel	
2.430.48	Ø 4.5 x 48 mm; thread 16; self tapping; stainless steel	
2.430.50	Ø 4.5 x 50 mm; thread 16; self tapping; stainless steel	
2.430.52	Ø 4.5 x 52 mm; thread 17; self tapping; stainless steel	
2.430.56	Ø 4.5 x 56 mm; thread 19; self tapping; stainless steel	
2.430.60	Ø 4.5 x 60 mm; thread 20; self tapping; stainless steel	
2.430.62	Ø 4.5 x 62 mm; thread 21; self tapping; stainless steel	
2.430.64	Ø 4.5 x 64 mm; thread 21; self tapping; stainless steel	
2.430.72	Ø 4.5 x 72 mm; thread 24; self tapping; stainless steel	
Cannulated screw 4.5 partial thread st bt sd		
2.434.20	Ø 4.5 x 20 mm; thread 7; self drilling; self tapping; back tapping; stainless steel	
2.434.22	Ø 4.5 x 22 mm; thread 7; self drilling; self tapping; back tapping; stainless steel	
2.434.24	Ø 4.5 x 24 mm; thread 8; self drilling; self tapping; back tapping; stainless steel	
2.434.26	Ø 4.5 x 26 mm; thread 9; self drilling; self tapping; back tapping; stainless steel	
2.434.28	Ø 4.5 x 28 mm; thread 9; self drilling; self tapping; back tapping; stainless steel	
2.434.30	Ø 4.5 x 30 mm; thread 10; self drilling; self tapping; back tapping; stainless steel	
2.434.32	Ø 4.5 x 32 mm; thread 11; self drilling; self tapping; back tapping; stainless steel	
2.434.34	Ø 4.5 x 34 mm; thread 11; self drilling; self tapping; back tapping; stainless steel	
2.434.36	Ø 4.5 x 36 mm; thread 12; self drilling; self tapping; back tapping; stainless steel	
2.434.38	Ø 4.5 x 38 mm; thread 13; self drilling; self tapping; back tapping; stainless steel	
2.434.40	Ø 4.5 x 40 mm; thread 13; self drilling; self tapping; back tapping; stainless steel	
2.434.42	Ø 4.5 x 42 mm; thread 14; self drilling; self tapping; back tapping; stainless steel	
2.434.44	Ø 4.5 x 44 mm; thread 15; self drilling; self tapping; back tapping; stainless steel	
2.434.46	Ø 4.5 x 46 mm; thread 15; self drilling; self tapping; back tapping; stainless steel	
2.434.48	Ø 4.5 x 48 mm; thread 16; self drilling; self tapping; back tapping; stainless steel	
2.434.50	Ø 4.5 x 50 mm; thread 16; self drilling; self tapping; back tapping; stainless steel	
2.434.52	Ø 4.5 x 52 mm; thread 17; self drilling; self tapping; back tapping; stainless steel	
2.434.54	Ø 4.5 x 54 mm; thread 18; self drilling; self tapping; back tapping; stainless steel	
2.434.56	Ø 4.5 x 56 mm; thread 19; self drilling; self tapping; back tapping; stainless steel	
2.434.72	Ø 4.5 x 72 mm; thread 24; self drilling; self tapping; back tapping; stainless steel	
Cannulated screw 4.5 st		
2.435.20	Ø 4.5 x 20 mm; fully threaded; self tapping; stainless steel	
2.435.24	Ø 4.5 x 24 mm; fully threaded; self tapping; stainless steel	
2.435.40	Ø 4.5 x 40 mm; fully threaded; self tapping; stainless steel	
2.435.42	Ø 4.5 x 42 mm; fully threaded; self tapping; stainless steel	











Cannulated screws

stainless steel

Item no.	Item description	EAN
2.435.46	Ø 4.5 x 46 mm; fully threaded; self tapping; stainless steel	
2.435.64	Ø 4.5 x 64 mm; fully threaded; self tapping; stainless steel	
2.435.68	Ø 4.5 x 68 mm; fully threaded; self tapping; stainless steel	
2.435.72	Ø 4.5 x 72 mm; fully threaded; self tapping; stainless steel	
Cannulated screw 6.5 thread 16 st bt sd		
2.520.30	Ø 6.5 x 30 mm; thread 16; self drilling; back tapping; self tapping; stainless steel	
2.520.35	Ø 6.5 x 35 mm; thread 16; self drilling; back tapping; self tapping; stainless steel	
2.520.40	Ø 6.5 x 40 mm; thread 16; self drilling; back tapping; self tapping; stainless steel	
2.520.45	Ø 6.5 x 45 mm; thread 16; self drilling; back tapping; self tapping; stainless steel	
2.520.50	Ø 6.5 x 50 mm; thread 16; self drilling; back tapping; self tapping; stainless steel	
2.520.55	Ø 6.5 x 55 mm; thread 16; self drilling; back tapping; self tapping; stainless steel	
2.520.60	Ø 6.5 x 60 mm; thread 16; self drilling; back tapping; self tapping; stainless steel	
2.520.65	Ø 6.5 x 65 mm; thread 16; self drilling; back tapping; self tapping; stainless steel	
2.520.70	Ø 6.5 x 70 mm; thread 16; self drilling; back tapping; self tapping; stainless steel	
2.520.75	Ø 6.5 x 75 mm; thread 16; self drilling; back tapping; self tapping; stainless steel	
2.520.80	Ø 6.5 x 80 mm; thread 16; self drilling; back tapping; self tapping; stainless steel	
2.520.85	Ø 6.5 x 85 mm; thread 16; self drilling; back tapping; self tapping; stainless steel	
2.520.90	Ø 6.5 x 90 mm; thread 16; self drilling; back tapping; self tapping; stainless steel	
2.520.95	Ø 6.5 x 95 mm; thread 16; self drilling; back tapping; self tapping; stainless steel	
2.520.100	Ø 6.5 x 100 mm; thread 16; self drilling; back tapping; self tapping; stainless steel	
2.520.105	Ø 6.5 x 105 mm; thread 16; self drilling; back tapping; self tapping; stainless steel	
2.520.110	Ø 6.5 x 110 mm; thread 16; self drilling; back tapping; self tapping; stainless steel	
2.520.115	Ø 6.5 x 115 mm; thread 16; self drilling; back tapping; self tapping; stainless steel	
2.520.120	Ø 6.5 x 120 mm; thread 16; self drilling; back tapping; self tapping; stainless steel	
2.520.125	Ø 6.5 x 125 mm; thread 16; self drilling; back tapping; self tapping; stainless steel	
2.520.130	Ø 6.5 x 130 mm; thread 16; self drilling; back tapping; self tapping; stainless steel	
2.520.135	Ø 6.5 x 135 mm; thread 16; self drilling; back tapping; self tapping; stainless steel	
2.520.140	Ø 6.5 x 140 mm; thread 16; self drilling; back tapping; self tapping; stainless steel	
Cannulated screw 6.5 thread 32 st bt sd		
2.523.45	Ø 6.5 x 45 mm; thread 32; self drilling; back tapping; self tapping; stainless steel	
2.523.50	Ø 6.5 x 50 mm; thread 32; self drilling; back tapping; self tapping; stainless steel	
2.523.55	Ø 6.5 x 55 mm; thread 32; self drilling; back tapping; self tapping; stainless steel	
2.523.60	Ø 6.5 x 60 mm; thread 32; self drilling; back tapping; self tapping; stainless steel	
2.523.65	Ø 6.5 x 65 mm; thread 32; self drilling; back tapping; self tapping; stainless steel	
2.523.70	Ø 6.5 x 70 mm; thread 32; self drilling; back tapping; self tapping; stainless steel	

Cannulated screws

stainless steel













Item no.	Item description	EAN
2.523.75	Ø 6.5 x 75 mm; thread 32; self drilling; back tapping; self tapping; stainless steel	 4 047075 058181
2.523.80	Ø 6.5 x 80 mm; thread 32; self drilling; back tapping; self tapping; stainless steel	 4 047075 058198
2.523.85	Ø 6.5 x 85 mm; thread 32; self drilling; back tapping; self tapping; stainless steel	 4 047075 058204
2.523.90	Ø 6.5 x 90 mm; thread 32; self drilling; back tapping; self tapping; stainless steel	 4 047075 058471
2.523.95	Ø 6.5 x 95 mm; thread 32; self drilling; back tapping; self tapping; stainless steel	 4 047075 058488
2.523.100	Ø 6.5 x 100 mm; thread 32; self drilling; back tapping; self tapping; stainless steel	 4 047075 057993
2.523.105	Ø 6.5 x 105 mm; thread 32; self drilling; back tapping; self tapping; stainless steel	 4 047075 058303
2.523.115	Ø 6.5 x 115 mm; thread 32; self drilling; back tapping; self tapping; stainless steel	 4 047075 058587
2.523.120	Ø 6.5 x 120 mm; thread 32; self drilling; back tapping; self tapping; stainless steel	 4 047075 058594
2.523.125	Ø 6.5 x 125 mm; thread 32; self drilling; back tapping; self tapping; stainless steel	 4 047075 058600
2.523.130	Ø 6.5 x 130 mm; thread 32; self drilling; back tapping; self tapping; stainless steel	 4 047075 058358
2.523.135	Ø 6.5 x 135 mm; thread 32; self drilling; back tapping; self tapping; stainless steel	 4 047075 058365
2.523.140	Ø 6.5 x 140 mm; thread 32; self drilling; back tapping; self tapping; stainless steel	 4 047075 058372
Cannulated screw 6.5 st bt sd		
2.525.45	Ø 6.5 x 45 mm; fully threaded; self drilling; back tapping; self tapping; stainless steel	 4 047075 058686
2.525.50	Ø 6.5 x 50 mm; fully threaded; self drilling; back tapping; self tapping; stainless steel	 4 047075 058433
2.525.55	Ø 6.5 x 55 mm; fully threaded; self drilling; back tapping; self tapping; stainless steel	 4 047075 058440
2.525.60	Ø 6.5 x 60 mm; fully threaded; self drilling; back tapping; self tapping; stainless steel	 4 047075 058457
2.525.65	Ø 6.5 x 65 mm; fully threaded; self drilling; back tapping; self tapping; stainless steel	 4 047075 058464
2.525.70	Ø 6.5 x 70 mm; fully threaded; self drilling; back tapping; self tapping; stainless steel	 4 047075 058730
2.525.75	Ø 6.5 x 75 mm; fully threaded; self drilling; back tapping; self tapping; stainless steel	 4 047075 058747
2.525.80	Ø 6.5 x 80 mm; fully threaded; self drilling; back tapping; self tapping; stainless steel	 4 047075 058754
2.525.85	Ø 6.5 x 85 mm; fully threaded; self drilling; back tapping; self tapping; stainless steel	 4 047075 058761
2.525.90	Ø 6.5 x 90 mm; fully threaded; self drilling; back tapping; self tapping; stainless steel	 4 047075 058518
2.525.95	Ø 6.5 x 95 mm; fully threaded; self drilling; back tapping; self tapping; stainless steel	 4 047075 058525
2.525.100	Ø 6.5 x 100 mm; fully threaded; self drilling; back tapping; self tapping; stainless steel	 4 047075 058495
2.525.110	Ø 6.5 x 110 mm; fully threaded; self drilling; back tapping; self tapping; stainless steel	 4 047075 058228
2.525.115	Ø 6.5 x 115 mm; fully threaded; self drilling; back tapping; self tapping; stainless steel	 4 047075 058235
2.525.120	Ø 6.5 x 120 mm; fully threaded; self drilling; back tapping; self tapping; stainless steel	 4 047075 058242
2.525.125	Ø 6.5 x 125 mm; fully threaded; self drilling; back tapping; self tapping; stainless steel	 4 047075 058648
2.525.130	Ø 6.5 x 130 mm; fully threaded; self drilling; back tapping; self tapping; stainless steel	 4 047075 058655
2.525.135	Ø 6.5 x 135 mm; fully threaded; self drilling; back tapping; self tapping; stainless steel	 4 047075 058662
2.525.140	Ø 6.5 x 140 mm; fully threaded; self drilling; back tapping; self tapping; stainless steel	 4 047075 058679

Cannulated screws

















stainless steel

Item no.	Item description	EAN
----------	------------------	-----

Cannulated screw 7.0 thread 10 bt

2.409.50	Ø 7.0 x 50 mm; thread 10; back tapping; stainless steel	
2.409.55	Ø 7.0 x 55 mm; thread 10; back tapping; stainless steel	
2.409.60	Ø 7.0 x 60 mm; thread 10; back tapping; stainless steel	
2.409.65	Ø 7.0 x 65 mm; thread 10; back tapping; stainless steel	
2.409.70	Ø 7.0 x 70 mm; thread 10; back tapping; stainless steel	
2.409.75	Ø 7.0 x 75 mm; thread 10; back tapping; stainless steel	
2.409.80	Ø 7.0 x 80 mm; thread 10; back tapping; stainless steel	
2.409.85	Ø 7.0 x 85 mm; thread 10; back tapping; stainless steel	
2.409.90	Ø 7.0 x 90 mm; thread 10; back tapping; stainless steel	
2.409.95	Ø 7.0 x 95 mm; thread 10; back tapping; stainless steel	
2.409.100	Ø 7.0 x 100 mm; thread 10; back tapping; stainless steel	
2.409.105	Ø 7.0 x 105 mm; thread 10; back tapping; stainless steel	
2.409.110	Ø 7.0 x 110 mm; thread 10; back tapping; stainless steel	

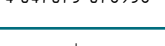
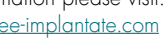
Cannulated screw 7.0 thread 16 st bt

2.412.30	Ø 7.0 x 30 mm; thread 16; back tapping; self tapping; stainless steel	
2.412.35	Ø 7.0 x 35 mm; thread 16; back tapping; self tapping; stainless steel	
2.412.40	Ø 7.0 x 40 mm; thread 16; back tapping; self tapping; stainless steel	
2.412.45	Ø 7.0 x 45 mm; thread 16; back tapping; self tapping; stainless steel	
2.412.50	Ø 7.0 x 50 mm; thread 16; back tapping; self tapping; stainless steel	
2.412.55	Ø 7.0 x 55 mm; thread 16; back tapping; self tapping; stainless steel	
2.412.60	Ø 7.0 x 60 mm; thread 16; back tapping; self tapping; stainless steel	
2.412.65	Ø 7.0 x 65 mm; thread 16; back tapping; self tapping; stainless steel	
2.412.70	Ø 7.0 x 70 mm; thread 16; back tapping; self tapping; stainless steel	
2.412.75	Ø 7.0 x 75 mm; thread 16; back tapping; self tapping; stainless steel	
2.412.80	Ø 7.0 x 80 mm; thread 16; back tapping; self tapping; stainless steel	
2.412.85	Ø 7.0 x 85 mm; thread 16; back tapping; self tapping; stainless steel	
2.412.90	Ø 7.0 x 90 mm; thread 16; back tapping; self tapping; stainless steel	
2.412.95	Ø 7.0 x 95 mm; thread 16; back tapping; self tapping; stainless steel	
2.412.100	Ø 7.0 x 100 mm; thread 16; back tapping; self tapping; stainless steel	
2.412.105	Ø 7.0 x 105 mm; thread 16; back tapping; self tapping; stainless steel	
2.412.110	Ø 7.0 x 110 mm; thread 16; back tapping; self tapping; stainless steel	
2.412.115	Ø 7.0 x 115 mm; thread 16; back tapping; self tapping; stainless steel	
2.412.120	Ø 7.0 x 120 mm; thread 16; back tapping; self tapping; stainless steel	
2.412.125	Ø 7.0 x 125 mm; thread 16; back tapping; self tapping; stainless steel	





























Cannulated screws

stainless steel

Item no.	Item description	EAN
2.412.130	Ø 7.0 x 130 mm; thread 16; back tapping; self tapping; stainless steel	 4 047075 076963
2.412.135	Ø 7.0 x 135 mm; thread 16; back tapping; self tapping; stainless steel	 4 047075 077090
2.412.140	Ø 7.0 x 140 mm; thread 16; back tapping; self tapping; stainless steel	 4 047075 077106
Cannulated screw 7.0 thread 16 st bt sd		
2.414.30	Ø 7.0 x 30 mm; thread 16; self drilling; back tapping; self tapping; stainless steel	 4 047075 077298
2.414.35	Ø 7.0 x 35 mm; thread 16; self drilling; back tapping; self tapping; stainless steel	 4 047075 077182
2.414.40	Ø 7.0 x 40 mm; thread 16; self drilling; back tapping; self tapping; stainless steel	 4 047075 077199
2.414.45	Ø 7.0 x 45 mm; thread 16; self drilling; back tapping; self tapping; stainless steel	 4 047075 077328
2.414.50	Ø 7.0 x 50 mm; thread 16; self drilling; back tapping; self tapping; stainless steel	 4 047075 077489
2.414.55	Ø 7.0 x 55 mm; thread 16; self drilling; back tapping; self tapping; stainless steel	 4 047075 077380
2.414.60	Ø 7.0 x 60 mm; thread 16; self drilling; back tapping; self tapping; stainless steel	 4 047075 077397
2.414.65	Ø 7.0 x 65 mm; thread 16; self drilling; back tapping; self tapping; stainless steel	 4 047075 077304
2.414.70	Ø 7.0 x 70 mm; thread 16; self drilling; back tapping; self tapping; stainless steel	 4 047075 077311
2.414.75	Ø 7.0 x 75 mm; thread 16; self drilling; back tapping; self tapping; stainless steel	 4 047075 077427
2.414.80	Ø 7.0 x 80 mm; thread 16; self drilling; back tapping; self tapping; stainless steel	 4 047075 077335
2.414.85	Ø 7.0 x 85 mm; thread 16; self drilling; back tapping; self tapping; stainless steel	 4 047075 077342
2.414.90	Ø 7.0 x 90 mm; thread 16; self drilling; back tapping; self tapping; stainless steel	 4 047075 077403
2.414.95	Ø 7.0 x 95 mm; thread 16; self drilling; back tapping; self tapping; stainless steel	 4 047075 077410
2.414.100	Ø 7.0 x 100 mm; thread 16; self drilling; back tapping; self tapping; stainless steel	 4 047075 077274
2.414.105	Ø 7.0 x 105 mm; thread 16; self drilling; back tapping; self tapping; stainless steel	 4 047075 077168
2.414.110	Ø 7.0 x 110 mm; thread 16; self drilling; back tapping; self tapping; stainless steel	 4 047075 077175
2.414.115	Ø 7.0 x 115 mm; thread 16; self drilling; back tapping; self tapping; stainless steel	 4 047075 077236
2.414.120	Ø 7.0 x 120 mm; thread 16; self drilling; back tapping; self tapping; stainless steel	 4 047075 077243
2.414.125	Ø 7.0 x 125 mm; thread 16; self drilling; back tapping; self tapping; stainless steel	 4 047075 077373
2.414.130	Ø 7.0 x 130 mm; thread 16; self drilling; back tapping; self tapping; stainless steel	 4 047075 077281
Cannulated screw 7.0 thread 32 st bt		
2.422.40	Ø 7.0 x 40 mm; thread 32; back tapping; self tapping; stainless steel	 4 047075 077748
2.422.45	Ø 7.0 x 45 mm; thread 32; back tapping; self tapping; stainless steel	 4 047075 077663
2.422.50	Ø 7.0 x 50 mm; thread 32; back tapping; self tapping; stainless steel	 4 047075 077670
2.422.55	Ø 7.0 x 55 mm; thread 32; back tapping; self tapping; stainless steel	 4 047075 077564
2.422.60	Ø 7.0 x 60 mm; thread 32; back tapping; self tapping; stainless steel	 4 047075 077731
2.422.65	Ø 7.0 x 65 mm; thread 32; back tapping; self tapping; stainless steel	 4 047075 077847
2.422.70	Ø 7.0 x 70 mm; thread 32; back tapping; self tapping; stainless steel	 4 047075 077854
2.422.75	Ø 7.0 x 75 mm; thread 32; back tapping; self tapping; stainless steel	 4 047075 077755
2.422.80	Ø 7.0 x 80 mm; thread 32; back tapping; self tapping; stainless steel	 4 047075 077762

Cannulated screws

stainless steel

Item no.	Item description	EAN
2.422.85	Ø 7.0 x 85 mm; thread 32; back tapping; self tapping; stainless steel	 4 047075 077687
2.422.90	Ø 7.0 x 90 mm; thread 32; back tapping; self tapping; stainless steel	 4 047075 077694
2.422.95	Ø 7.0 x 95 mm; thread 32; back tapping; self tapping; stainless steel	 4 047075 077793
2.422.100	Ø 7.0 x 100 mm; thread 32; back tapping; self tapping; stainless steel	 4 047075 077618
2.422.105	Ø 7.0 x 105 mm; thread 32; back tapping; self tapping; stainless steel	 4 047075 077519
2.422.110	Ø 7.0 x 110 mm; thread 32; back tapping; self tapping; stainless steel	 4 047075 077526
2.422.115	Ø 7.0 x 115 mm; thread 32; back tapping; self tapping; stainless steel	 4 047075 077649
2.422.120	Ø 7.0 x 120 mm; thread 32; back tapping; self tapping; stainless steel	 4 047075 077717
2.422.125	Ø 7.0 x 125 mm; thread 32; back tapping; self tapping; stainless steel	 4 047075 077724
2.422.130	Ø 7.0 x 130 mm; thread 32; back tapping; self tapping; stainless steel	 4 047075 077625
Cannulated screw 7.0 thread 32 st bt sd		
2.424.40	Ø 7.0 x 40 mm; thread 32; self drilling; back tapping; self tapping; stainless steel	 4 047075 077892
2.424.45	Ø 7.0 x 45 mm; thread 32; self drilling; back tapping; self tapping; stainless steel	 4 047075 077908
2.424.50	Ø 7.0 x 50 mm; thread 32; self drilling; back tapping; self tapping; stainless steel	 4 047075 078028
2.424.55	Ø 7.0 x 55 mm; thread 32; self drilling; back tapping; self tapping; stainless steel	 4 047075 078035
2.424.60	Ø 7.0 x 60 mm; thread 32; self drilling; back tapping; self tapping; stainless steel	 4 047075 077939
2.424.65	Ø 7.0 x 65 mm; thread 32; self drilling; back tapping; self tapping; stainless steel	 4 047075 077946
2.424.70	Ø 7.0 x 70 mm; thread 32; self drilling; back tapping; self tapping; stainless steel	 4 047075 077823
2.424.75	Ø 7.0 x 75 mm; thread 32; self drilling; back tapping; self tapping; stainless steel	 4 047075 077830
2.424.80	Ø 7.0 x 80 mm; thread 32; self drilling; back tapping; self tapping; stainless steel	 4 047075 077977
2.424.85	Ø 7.0 x 85 mm; thread 32; self drilling; back tapping; self tapping; stainless steel	 4 047075 078042
2.424.90	Ø 7.0 x 90 mm; thread 32; self drilling; back tapping; self tapping; stainless steel	 4 047075 078059
2.424.95	Ø 7.0 x 95 mm; thread 32; self drilling; back tapping; self tapping; stainless steel	 4 047075 077953
2.424.100	Ø 7.0 x 100 mm; thread 32; self drilling; back tapping; self tapping; stainless steel	 4 047075 077878
2.424.105	Ø 7.0 x 105 mm; thread 32; self drilling; back tapping; self tapping; stainless steel	 4 047075 077779
2.424.110	Ø 7.0 x 110 mm; thread 32; self drilling; back tapping; self tapping; stainless steel	 4 047075 077786
2.424.115	Ø 7.0 x 115 mm; thread 32; self drilling; back tapping; self tapping; stainless steel	 4 047075 077915
2.424.120	Ø 7.0 x 120 mm; thread 32; self drilling; back tapping; self tapping; stainless steel	 4 047075 077922
2.424.125	Ø 7.0 x 125 mm; thread 32; self drilling; back tapping; self tapping; stainless steel	 4 047075 077809
2.424.130	Ø 7.0 x 130 mm; thread 32; self drilling; back tapping; self tapping; stainless steel	 4 047075 077816

Washers

Titanium



Item no. 3.203.35



Item no. 3.200.12



Item no. 3.202.40



Item no. 3.200.04

Item no.	Item description	EAN
Inside diameter Ø 2.2 mm		
3.200.05	washer; outside Ø 4.5 mm / inside Ø 2.2 mm; titanium	4 047075 094363
Inside diameter Ø 3.0 mm		
3.200.10	washer; outside Ø 6.0 mm / inside Ø 3.0 mm; titanium	4 047075 094370
Inside diameter Ø 3.7 mm		
3.200.11	washer; outside Ø 10 mm / inside Ø 3.7 mm; titanium	4 047075 094295
Inside diameter Ø 3.8 mm		
3.200.02	washer; outside Ø 7.0 mm / inside Ø 3.8 mm; titanium	4 047075 094349
Inside diameter Ø 4.1 mm		
3.202.35	washer with 4 spikes; outside Ø 10 mm / inside Ø 4.1 mm; titanium	4 047075 094387
3.203.35	washer with 10 spikes; outside Ø 10 mm / inside Ø 4.1 mm; titanium	4 047075 094622
Inside diameter Ø 4.5 mm		
3.200.12	washer; outside Ø 7.0 mm / inside Ø 4.5 mm; titanium	4 047075 094462
Inside diameter Ø 5.0 mm		
3.200.40	washer; outside Ø 10 mm / inside Ø 5.0 mm; titanium	4 047075 094509
3.202.40	washer with 4 spikes; outside Ø 10.1 mm / inside Ø 5.0 mm; titanium	4 047075 094523
3.203.40	washer with 10 spikes; outside Ø 10 mm / inside Ø 5.0 mm; titanium	4 047075 094516

Washers

Titanium



Item no. 3.203.35



Item no. 3.200.12



Item no. 3.202.40



Item no. 3.200.04

Item no.	Item description	EAN
----------	------------------	-----

Inside diameter Ø 6.7 mm

3.200.03	washer; outside Ø 13 mm / inside Ø 6.7 mm; titanium	4 047075 094479
3.200.04	washer; outside Ø 16 mm / inside Ø 6.7 mm; titanium	4 047075 094356
3.202.45	washer with 4 spikes; outside Ø 13.4 mm / inside Ø 6.7 mm; titanium	4 047075 094400
3.202.65	washer with 4 spikes; outside Ø 16 mm / inside Ø 6.7 mm; titanium	4 047075 094417
3.203.45	washer with 10 spikes; outside Ø 13.4 mm / inside Ø 6.7 mm; titanium	4 047075 094666
3.203.65	washer with 10 spikes; outside Ø 16 mm / inside Ø 6.7 mm; titanium	4 047075 094530

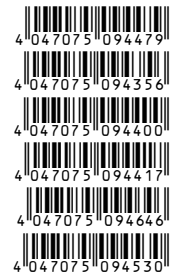

Washers

Stainless steel



Item no. 2.200.05



Item no. 2.200.02



Item no. 2.202.35

Item no.	Item description	EAN
Inside diameter Ø 2.2 mm		
2.200.05	washer; outside-Ø 4,5 mm / inside-Ø 2,2 mm; stainless steel	4 047075 062515
Inside diameter Ø 3.0 mm		
2.200.10	washer; outside-Ø 6,0 mm / inside-Ø 3,0 mm; stainless steel	4 047075 062447
Inside diameter Ø 3.7 mm		
2.200.11	washer; outside-Ø 10 mm / inside-Ø 3,7 mm; stainless steel	4 047075 062362
Inside diameter Ø 3.8 mm		
2.200.02	washer; outside-Ø 7,0 mm / inside-Ø 3,8 mm; stainless steel	4 047075 062614
Inside diameter Ø 4.1 mm		
2.202.35	washer with 4 spikes; outside-Ø 10 mm / inside-Ø 4,1 mm; stainless steel	4 047075 062300
2.203.35	washer with 10 spikes; outside-Ø 10 mm / inside-Ø 4,1 mm; stainless steel	4 047075 062256
Inside diameter Ø 4.5 mm		
2.200.06	washer; outside-Ø 9,0 mm / inside-Ø 4,5 mm; stainless steel	4 047075 062416
2.200.12	washer; outside-Ø 7,0 mm / inside-Ø 4,5 mm; stainless steel	4 047075 062379
2.200.13	washer; outside-Ø 8,0 mm / inside-Ø 4,5 mm; stainless steel	4 047075 062485
Inside diameter Ø 4.8 mm		
2.200.07	washer; outside-Ø 11 mm / inside-Ø 4,8 mm; stainless steel	4 047075 062560

Washers

Stainless steel



Item no. 2.200.05



Item no. 2.200.02



Item no. 2.202.35



Item no.	Item description	EAN
Inside diameter Ø 5.0 mm		
2.200.40	washer; outside-Ø 10 mm / inside-Ø 5,0 mm; stainless steel	4 047075 062409
2.202.40	washer with 4 spikes; outside-Ø 10,1 mm / inside-Ø 5,0 mm; stainless steel	4 047075 062423
Inside diameter Ø 6.7 mm		
2.200.03	washer; outside-Ø 13 mm / inside-Ø 6,7 mm; stainless steel	4 047075 062492
2.200.04	washer; outside-Ø 16 mm / inside-Ø 6,7 mm; stainless steel	4 047075 062508
2.202.45	washer with 4 spikes; outside-Ø 13,4 mm / inside-Ø 6,7 mm; stainless steel	4 047075 062331
2.203.45	washer with 10 spikes; outside-Ø 13,4 mm / inside-Ø 6,7 mm; stainless steel	4 047075 062270
2.203.65	washer with 10 spikes; outside-Ø 16 mm / inside-Ø 6,7 mm; stainless steel	4 047075 062287

SCREWS

Königsee Implantate



Your Partner in Osteosynthesis

-  Mini fragment
-  Small fragment
-  Large fragment

Cortical screws

Standard; titanium



Item no. 3.100.10



Item no. 3.110.10



Item no. 3.0224.16



Item no. 3.120.20



Item no. 3.128.30



Item no. 3.1281.18



Item no. 3.130.30



Item no. 3.132.30



Item no. 3.138.30



Item no. 3.150.30



Item no. 3.152.30

Item no.	Item description	EAN
----------	------------------	-----

Cortical screw 1.5 st

































3.100.06	cortical screw; Ø 1.5 x 6; fully threaded; self tapping; titanium	4 047075 087457
3.100.07	cortical screw; Ø 1.5 x 7; fully threaded; self tapping; titanium	4 047075 087563
3.100.08	cortical screw; Ø 1.5 x 8; fully threaded; self tapping; titanium	4 047075 087471
3.100.09	cortical screw; Ø 1.5 x 9; fully threaded; self tapping; titanium	4 047075 087488
3.100.10	cortical screw; Ø 1.5 x 10; fully threaded; self tapping; titanium	4 047075 087495
3.100.11	cortical screw; Ø 1.5 x 11; fully threaded; self tapping; titanium	4 047075 087389
3.100.12	cortical screw; Ø 1.5 x 12; fully threaded; self tapping; titanium	4 047075 087396
3.100.13	cortical screw; Ø 1.5 x 13; fully threaded; self tapping; titanium	4 047075 087419
3.100.14	cortical screw; Ø 1.5 x 14; fully threaded; self tapping; titanium	4 047075 087587
3.100.15	cortical screw; Ø 1.5 x 15; fully threaded; self tapping; titanium	4 047075 087594
3.100.16	cortical screw; Ø 1.5 x 16; fully threaded; self tapping; titanium	4 047075 087600
3.100.18	cortical screw; Ø 1.5 x 18; fully threaded; self tapping; titanium	4 047075 087501
3.100.20	cortical screw; Ø 1.5 x 20; fully threaded; self tapping; titanium	4 047075 087624
3.100.22	cortical screw; Ø 1.5 x 22; fully threaded; self tapping; titanium	4 047075 115631
3.100.24	cortical screw; Ø 1.5 x 24; fully threaded; self tapping; titanium	4 047075 115648

Cortical screw 2.0 st

3.110.06	cortical screw; Ø 2 x 6; fully threaded; self tapping; titanium	4 047075 087525
3.110.07	cortical screw; Ø 2 x 7; fully threaded; self tapping; titanium	4 047075 087532
3.110.08	cortical screw; Ø 2 x 8; fully threaded; self tapping; titanium	4 047075 087617
3.110.09	cortical screw; Ø 2 x 9; fully threaded; self tapping; titanium	4 047075 121366
3.110.10	cortical screw; Ø 2 x 10; fully threaded; self tapping; titanium	4 047075 087723
3.110.11	cortical screw; Ø 2 x 11; fully threaded; self tapping; titanium	4 047075 121373
3.110.12	cortical screw; Ø 2 x 12; fully threaded; self tapping; titanium	4 047075 087631
3.110.13	cortical screw; Ø 2 x 13; fully threaded; self tapping; titanium	4 047075 121380
3.110.14	cortical screw; Ø 2 x 14; fully threaded; self tapping; titanium	4 047075 087648
3.110.16	cortical screw; Ø 2 x 16; fully threaded; self tapping; titanium	4 047075 087655



































Cortical screws

Standard; titanium

Item no.	Item description	EAN
3.110.18	cortical screw; Ø 2 x 18; fully threaded; self tapping; titanium	 4 047075 087549
3.110.20	cortical screw; Ø 2 x 20; fully threaded; self tapping; titanium	 4 047075 087556
3.110.22	cortical screw; Ø 2 x 22; fully threaded; self tapping; titanium	 4 047075 087570
3.110.24	cortical screw; Ø 2 x 24; fully threaded; self tapping; titanium	 4 047075 087747
3.110.26	cortical screw; Ø 2 x 26; fully threaded; self tapping; titanium	 4 047075 087754
3.110.28	cortical screw; Ø 2 x 28; fully threaded; self tapping; titanium	 4 047075 087761
3.110.30	cortical screw; Ø 2 x 30; fully threaded; self tapping; titanium	 4 047075 087662
3.110.32	cortical screw; Ø 2 x 32; fully threaded; self tapping; titanium	 4 047075 087785
3.110.34	cortical screw; Ø 2 x 34; fully threaded; self tapping; titanium	 4 047075 087679
3.110.36	cortical screw; Ø 2 x 36; fully threaded; self tapping; titanium	 4 047075 087686
3.110.38	cortical screw; Ø 2 x 38; fully threaded; self tapping; titanium	 4 047075 087693
3.110.40	cortical screw; Ø 2 x 40; fully threaded; self tapping; titanium	 4 047075 087778
Cortical screw 2.4 SL8 st		
3.0224.12	cortical screw; Ø 2.4 x 12; fully threaded; self tapping; titanium	 4 047075 178018
3.0224.14	cortical screw; Ø 2.4 x 14; fully threaded; self tapping; titanium	 4 047075 178025
3.0224.16	cortical screw; Ø 2.4 x 16; fully threaded; self tapping; titanium	 4 047075 178032
3.0224.18	cortical screw; Ø 2.4 x 18; fully threaded; self tapping; titanium	 4 047075 178049
3.0224.20	cortical screw; Ø 2.4 x 20; fully threaded; self tapping; titanium	 4 047075 178056
Cortical screw 2.7 st		
3.120.06	cortical screw; Ø 2.7 x 6; fully threaded; self tapping; titanium	 4 047075 088034
3.120.08	cortical screw; Ø 2.7 x 8; fully threaded; self tapping; titanium	 4 047075 088041
3.120.10	cortical screw; Ø 2.7 x 10; fully threaded; self tapping; titanium	 4 047075 088133
3.120.12	cortical screw; Ø 2.7 x 12; fully threaded; self tapping; titanium	 4 047075 088249
3.120.13	cortical screw; Ø 2.7 x 13; fully threaded; self tapping; titanium	 4 047075 147342
3.120.14	cortical screw; Ø 2.7 x 14; fully threaded; self tapping; titanium	 4 047075 088157
3.120.15	cortical screw; Ø 2.7 x 15; fully threaded; self tapping; titanium	 4 047075 147359
3.120.16	cortical screw; Ø 2.7 x 16; fully threaded; self tapping; titanium	 4 047075 088164
3.120.17	cortical screw; Ø 2.7 x 17; fully threaded; self tapping; titanium	 4 047075 147366
3.120.18	cortical screw; Ø 2.7 x 18; fully threaded; self tapping; titanium	 4 047075 088171
3.120.19	cortical screw; Ø 2.7 x 19; fully threaded; self tapping; titanium	 4 047075 147373
3.120.20	cortical screw; Ø 2.7 x 20; fully threaded; self tapping; titanium	 4 047075 088058
3.120.22	cortical screw; Ø 2.7 x 22; fully threaded; self tapping; titanium	 4 047075 088065
3.120.24	cortical screw; Ø 2.7 x 24; fully threaded; self tapping; titanium	 4 047075 088089
3.120.26	cortical screw; Ø 2.7 x 26; fully threaded; self tapping; titanium	 4 047075 088263
3.120.28	cortical screw; Ø 2.7 x 28; fully threaded; self tapping; titanium	 4 047075 088270

































Cortical screws

Standard; titanium

Item no.	Item description	EAN
3.120.30	cortical screw; Ø 2.7 x 30; fully threaded; self tapping; titanium	 4 047075 088287
3.120.32	cortical screw; Ø 2.7 x 32; fully threaded; self tapping; titanium	 4 047075 088188
3.120.34	cortical screw; Ø 2.7 x 34; fully threaded; self tapping; titanium	 4 047075 088300
3.120.36	cortical screw; Ø 2.7 x 36; fully threaded; self tapping; titanium	 4 047075 088195
3.120.38	cortical screw; Ø 2.7 x 38; fully threaded; self tapping; titanium	 4 047075 088201
3.120.40	cortical screw; Ø 2.7 x 40; fully threaded; self tapping; titanium	 4 047075 088218
3.120.42	cortical screw; Ø 2.7 x 42; fully threaded; self tapping; titanium	 4 047075 088294
3.120.44	cortical screw; Ø 2.7 x 44; fully threaded; self tapping; titanium	 4 047075 088393
3.120.46	cortical screw; Ø 2.7 x 46; fully threaded; self tapping; titanium	 4 047075 088317
3.120.48	cortical screw; Ø 2.7 x 48; fully threaded; self tapping; titanium	 4 047075 088324
3.120.50	cortical screw; Ø 2.7 x 50; fully threaded; self tapping; titanium	 4 047075 088331
3.120.55	cortical screw; Ø 2.7 x 55; fully threaded; self tapping; titanium	 4 047075 160259
3.120.60	cortical screw; Ø 2.7 x 60; fully threaded; self tapping; titanium	 4 047075 160266
3.120.65	cortical screw; Ø 2.7 x 65; fully threaded; self tapping; titanium	 4 047075 160273
3.120.70	cortical screw; Ø 2.7 x 70; fully threaded; self tapping; titanium	 4 047075 160280
Cortical screw 2.7 flat head st		
3.128.10	cortical screw; Ø 2.7 x 10; fully threaded; self tapping; flat head; titanium	 4 047075 133093
3.128.12	cortical screw; Ø 2.7 x 12; fully threaded; self tapping; flat head; titanium	 4 047075 133109
3.128.14	cortical screw; Ø 2.7 x 14; fully threaded; self tapping; flat head; titanium	 4 047075 133116
3.128.16	cortical screw; Ø 2.7 x 16; fully threaded; self tapping; flat head; titanium	 4 047075 133123
3.128.18	cortical screw; Ø 2.7 x 18; fully threaded; self tapping; flat head; titanium	 4 047075 133130
3.128.20	cortical screw; Ø 2.7 x 20; fully threaded; self tapping; flat head; titanium	 4 047075 133147
3.128.22	cortical screw; Ø 2.7 x 22; fully threaded; self tapping; flat head; titanium	 4 047075 133154
3.128.24	cortical screw; Ø 2.7 x 24; fully threaded; self tapping; flat head; titanium	 4 047075 133161
3.128.26	cortical screw; Ø 2.7 x 26; fully threaded; self tapping; flat head; titanium	 4 047075 133178
3.128.28	cortical screw; Ø 2.7 x 28; fully threaded; self tapping; flat head; titanium	 4 047075 133185
3.128.30	cortical screw; Ø 2.7 x 30; fully threaded; self tapping; flat head; titanium	 4 047075 133192
3.128.32	cortical screw; Ø 2.7 x 32; fully threaded; self tapping; flat head; titanium	 4 047075 133208
3.128.34	cortical screw; Ø 2.7 x 34; fully threaded; self tapping; flat head; titanium	 4 047075 133215
3.128.36	cortical screw; Ø 2.7 x 36; fully threaded; self tapping; flat head; titanium	 4 047075 133222
3.128.38	cortical screw; Ø 2.7 x 38; fully threaded; self tapping; flat head; titanium	 4 047075 133239
3.128.40	cortical screw; Ø 2.7 x 40; fully threaded; self tapping; flat head; titanium	 4 047075 133246
3.128.42	cortical screw; Ø 2.7 x 42; fully threaded; self tapping; flat head; titanium	 4 047075 133253
3.128.44	cortical screw; Ø 2.7 x 44; fully threaded; self tapping; flat head; titanium	 4 047075 133260
3.128.46	cortical screw; Ø 2.7 x 46; fully threaded; self tapping; flat head; titanium	 4 047075 133277













Cortical screws

Standard; titanium

Item no.	Item description	EAN
3.128.48	cortical screw; Ø 2.7 x 48; fully threaded; self tapping; flat head; titanium	 4 047075 133284
3.128.50	cortical screw; Ø 2.7 x 50; fully threaded; self tapping; flat head; titanium	 4 047075 133291
Cortical screw 2.7 flat head SL10 st		
3.1281.08	cortical screw; Ø 2.7 x 08; fully threaded; self tapping; flat head; t 10; titanium	 4 047075 144266
3.1281.10	cortical screw; Ø 2.7 x 10; fully threaded; self tapping; flat head; t 10; titanium	 4 047075 142774
3.1281.12	cortical screw; Ø 2.7 x 12; fully threaded; self tapping; flat head; t 10; titanium	 4 047075 142781
3.1281.13	cortical screw; Ø 2.7 x 13; fully threaded; self tapping; flat head; t 10; titanium	 4 047075 150359
3.1281.14	cortical screw; Ø 2.7 x 14; fully threaded; self tapping; flat head; t 10; titanium	 4 047075 142798
3.1281.15	cortical screw; Ø 2.7 x 15; fully threaded; self tapping; flat head; t 10; titanium	 4 047075 150366
3.1281.16	cortical screw; Ø 2.7 x 16; fully threaded; self tapping; flat head; t 10; titanium	 4 047075 142804
3.1281.17	cortical screw; Ø 2.7 x 17; fully threaded; self tapping; flat head; t 10; titanium	 4 047075 150373
3.1281.18	cortical screw; Ø 2.7 x 18; fully threaded; self tapping; flat head; t 10; titanium	 4 047075 142811
3.1281.19	cortical screw; Ø 2.7 x 19; fully threaded; self tapping; flat head; t 10; titanium	 4 047075 150380
3.1281.20	cortical screw; Ø 2.7 x 20; fully threaded; self tapping; flat head; t 10; titanium	 4 047075 142828
3.1281.22	cortical screw; Ø 2.7 x 22; fully threaded; self tapping; flat head; t 10; titanium	 4 047075 142835
3.1281.24	cortical screw; Ø 2.7 x 24; fully threaded; self tapping; flat head; t 10; titanium	 4 047075 142842
3.1281.26	cortical screw; Ø 2.7 x 26; fully threaded; self tapping; flat head; t 10; titanium	 4 047075 142859
3.1281.28	cortical screw; Ø 2.7 x 28; fully threaded; self tapping; flat head; t 10; titanium	 4 047075 142866
3.1281.30	cortical screw; Ø 2.7 x 30; fully threaded; self tapping; flat head; t 10; titanium	 4 047075 142873
3.1281.32	cortical screw; Ø 2.7 x 32; fully threaded; self tapping; flat head; t 10; titanium	 4 047075 142880
3.1281.34	cortical screw; Ø 2.7 x 34; fully threaded; self tapping; flat head; t 10; titanium	 4 047075 142897
3.1281.36	cortical screw; Ø 2.7 x 36; fully threaded; self tapping; flat head; t 10; titanium	 4 047075 142903
3.1281.38	cortical screw; Ø 2.7 x 38; fully threaded; self tapping; flat head; t 10; titanium	 4 047075 142910
3.1281.40	cortical screw; Ø 2.7 x 40; fully threaded; self tapping; flat head; t 10; titanium	 4 047075 142927
Cortical screw 3.5 - on sale, only a few available. Please use the self-tapping alternative article		
3.130.08	cortical screw; Ø 3.5 x 8; fully threaded; titanium	 4 047075 088713
3.130.10	cortical screw; Ø 3.5 x 10; fully threaded; titanium	 4 047075 088881
3.130.12	cortical screw; Ø 3.5 x 12; fully threaded; titanium	 4 047075 088775
3.130.14	cortical screw; Ø 3.5 x 14; fully threaded; titanium	 4 047075 088904
3.130.16	cortical screw; Ø 3.5 x 16; fully threaded; titanium	 4 047075 088928
3.130.18	cortical screw; Ø 3.5 x 18; fully threaded; titanium	 4 047075 088935
3.130.20	cortical screw; Ø 3.5 x 20; fully threaded; titanium	 4 047075 088782
3.130.22	cortical screw; Ø 3.5 x 22; fully threaded; titanium	 4 047075 088799
3.130.24	cortical screw; Ø 3.5 x 24; fully threaded; titanium	 4 047075 088966
3.130.26	cortical screw; Ø 3.5 x 26; fully threaded; titanium	 4 047075 088812

Cortical screws

Standard; titanium

Item no.	Item description	EAN
3.130.28	cortical screw; Ø 3.5 x 28; fully threaded; titanium	 4 047075 088829
3.130.30	cortical screw; Ø 3.5 x 30; fully threaded; titanium	 4 047075 089079
3.130.32	cortical screw; Ø 3.5 x 32; fully threaded; titanium	 4 047075 089086
3.130.34	cortical screw; Ø 3.5 x 34; fully threaded; titanium	 4 047075 089093
3.130.36	cortical screw; Ø 3.5 x 36; fully threaded; titanium	 4 047075 088942
3.130.38	cortical screw; Ø 3.5 x 38; fully threaded; titanium	 4 047075 088959
3.130.40	cortical screw; Ø 3.5 x 40; fully threaded; titanium	 4 047075 089123
3.130.42	cortical screw; Ø 3.5 x 42; fully threaded; titanium	 4 047075 088973
3.130.44	cortical screw; Ø 3.5 x 44; fully threaded; titanium	 4 047075 088980
3.130.45	cortical screw; Ø 3.5 x 45; fully threaded; titanium	 4 047075 088997
3.130.46	cortical screw; Ø 3.5 x 46; fully threaded; titanium	 4 047075 089000
3.130.48	cortical screw; Ø 3.5 x 48; fully threaded; titanium	 4 047075 089017
3.130.50	cortical screw; Ø 3.5 x 50; fully threaded; titanium	 4 047075 088867
3.130.55	cortical screw; Ø 3.5 x 55; fully threaded; titanium	 4 047075 089291
3.130.60	cortical screw; Ø 3.5 x 60; fully threaded; titanium	 4 047075 089130
3.130.65	cortical screw; Ø 3.5 x 65; fully threaded; titanium	 4 047075 089147
3.130.70	cortical screw; Ø 3.5 x 70; fully threaded; titanium	 4 047075 089154
3.130.75	cortical screw; Ø 3.5 x 75; fully threaded; titanium	 4 047075 089161
3.130.80	cortical screw; Ø 3.5 x 80; fully threaded; titanium	 4 047075 089178
3.130.85	cortical screw; Ø 3.5 x 85; fully threaded; titanium	 4 047075 089024
3.130.90	cortical screw; Ø 3.5 x 90; fully threaded; titanium	 4 047075 089031
3.130.95	cortical screw; Ø 3.5 x 95; fully threaded; titanium	 4 047075 089192
3.130.100	cortical screw; Ø 3.5 x 100; fully threaded; titanium	 4 047075 088737
3.130.105	cortical screw; Ø 3.5 x 105; fully threaded; titanium	 4 047075 088744
3.130.110	cortical screw; Ø 3.5 x 110; fully threaded; titanium	 4 047075 088751
3.130.115	cortical screw; Ø 3.5 x 115; fully threaded; titanium	 4 047075 088768
3.130.120	cortical screw; Ø 3.5 x 120; fully threaded; titanium	 4 047075 088645
3.130.125	cortical screw; Ø 3.5 x 125; fully threaded; titanium	 4 047075 088874
3.130.130	cortical screw; Ø 3.5 x 130; fully threaded; titanium	 4 047075 089048
3.130.135	cortical screw; Ø 3.5 x 135; fully threaded; titanium	 4 047075 088898
3.130.140	cortical screw; Ø 3.5 x 140; fully threaded; titanium	 4 047075 088911
Cortical screw 3.5 st		
3.132.08	cortical screw; Ø 3.5 x 8; fully threaded; self tapping; titanium	 4 047075 089062
3.132.10	cortical screw; Ø 3.5 x 10; fully threaded; self tapping; titanium	 4 047075 089338
3.132.12	cortical screw; Ø 3.5 x 12; fully threaded; self tapping; titanium	 4 047075 089390































Cortical screws

Standard; titanium

Item no.	Item description	EAN
3.132.14	cortical screw; Ø 3.5 x 14; fully threaded; self tapping; titanium	 4 047075 089246
3.132.16	cortical screw; Ø 3.5 x 16; fully threaded; self tapping; titanium	 4 047075 089260
3.132.18	cortical screw; Ø 3.5 x 18; fully threaded; self tapping; titanium	 4 047075 089109
3.132.20	cortical screw; Ø 3.5 x 20; fully threaded; self tapping; titanium	 4 047075 089116
3.132.22	cortical screw; Ø 3.5 x 22; fully threaded; self tapping; titanium	 4 047075 089567
3.132.24	cortical screw; Ø 3.5 x 24; fully threaded; self tapping; titanium	 4 047075 089406
3.132.26	cortical screw; Ø 3.5 x 26; fully threaded; self tapping; titanium	 4 047075 089413
3.132.28	cortical screw; Ø 3.5 x 28; fully threaded; self tapping; titanium	 4 047075 089420
3.132.30	cortical screw; Ø 3.5 x 30; fully threaded; self tapping; titanium	 4 047075 089437
3.132.32	cortical screw; Ø 3.5 x 32; fully threaded; self tapping; titanium	 4 047075 089444
3.132.34	cortical screw; Ø 3.5 x 34; fully threaded; self tapping; titanium	 4 047075 089277
3.132.35	cortical screw; Ø 3.5 x 35; fully threaded; self tapping; titanium	 4 047075 089284
3.132.36	cortical screw; Ø 3.5 x 36; fully threaded; self tapping; titanium	 4 047075 089475
3.132.38	cortical screw; Ø 3.5 x 38; fully threaded; self tapping; titanium	 4 047075 089307
3.132.40	cortical screw; Ø 3.5 x 40; fully threaded; self tapping; titanium	 4 047075 089314
3.132.42	cortical screw; Ø 3.5 x 42; fully threaded; self tapping; titanium	 4 047075 089321
3.132.44	cortical screw; Ø 3.5 x 44; fully threaded; self tapping; titanium	 4 047075 089611
3.132.45	cortical screw; Ø 3.5 x 45; fully threaded; self tapping; titanium	 4 047075 089628
3.132.46	cortical screw; Ø 3.5 x 46; fully threaded; self tapping; titanium	 4 047075 089451
3.132.48	cortical screw; Ø 3.5 x 48; fully threaded; self tapping; titanium	 4 047075 089468
3.132.50	cortical screw; Ø 3.5 x 50; fully threaded; self tapping; titanium	 4 047075 089659
3.132.55	cortical screw; Ø 3.5 x 55; fully threaded; self tapping; titanium	 4 047075 089482
3.132.60	cortical screw; Ø 3.5 x 60; fully threaded; self tapping; titanium	 4 047075 089499
3.132.65	cortical screw; Ø 3.5 x 65; fully threaded; self tapping; titanium	 4 047075 089505
3.132.70	cortical screw; Ø 3.5 x 70; fully threaded; self tapping; titanium	 4 047075 089512
3.132.75	cortical screw; Ø 3.5 x 75; fully threaded; self tapping; titanium	 4 047075 089529
3.132.80	cortical screw; Ø 3.5 x 80; fully threaded; self tapping; titanium	 4 047075 089369
3.132.85	cortical screw; Ø 3.5 x 85; fully threaded; self tapping; titanium	 4 047075 089376
3.132.90	cortical screw; Ø 3.5 x 90; fully threaded; self tapping; titanium	 4 047075 089857
3.132.95	cortical screw; Ø 3.5 x 95; fully threaded; self tapping; titanium	 4 047075 089666
3.132.100	cortical screw; Ø 3.5 x 100; fully threaded; self tapping; titanium	 4 047075 089345
3.132.105	cortical screw; Ø 3.5 x 105; fully threaded; self tapping; titanium	 4 047075 089352
3.132.110	cortical screw; Ø 3.5 x 110; fully threaded; self tapping; titanium	 4 047075 089185
3.132.115	cortical screw; Ø 3.5 x 115; fully threaded; self tapping; titanium	 4 047075 089383
3.132.120	cortical screw; Ø 3.5 x 120; fully threaded; self tapping; titanium	 4 047075 089208

Cortical screws

Standard; titanium

Item no.	Item description	EAN
3.132.125	cortical screw; Ø 3.5 x 125; fully threaded; self tapping; titanium	 4 047075 089215
3.132.130	cortical screw; Ø 3.5 x 130; fully threaded; self tapping; titanium	 4 047075 089222
3.132.135	cortical screw; Ø 3.5 x 135; fully threaded; self tapping; titanium	 4 047075 089239
3.132.140	cortical screw; Ø 3.5 x 140; fully threaded; self tapping; titanium	 4 047075 089253
Cortical screw 3.5 st head 5		
3.138.10	cortical screw; Ø 3.5 x 10; fully threaded; head 5.0; self tapping; titanium; TiOB®	 4 047075 131808
3.138.12	cortical screw; Ø 3.5 x 12; fully threaded; head 5.0; self tapping; titanium; TiOB®	 4 047075 131815
3.138.14	cortical screw; Ø 3.5 x 14; fully threaded; head 5.0; self tapping; titanium; TiOB®	 4 047075 131839
3.138.16	cortical screw; Ø 3.5 x 16; fully threaded; head 5.0; self tapping; titanium; TiOB®	 4 047075 131846
3.138.18	cortical screw; Ø 3.5 x 18; fully threaded; head 5.0; self tapping; titanium; TiOB®	 4 047075 131853
3.138.20	cortical screw; Ø 3.5 x 20; fully threaded; head 5.0; self tapping; titanium; TiOB®	 4 047075 131860
3.138.22	cortical screw; Ø 3.5 x 22; fully threaded; head 5.0; self tapping; titanium; TiOB®	 4 047075 132324
3.138.24	cortical screw; Ø 3.5 x 24; fully threaded; head 5.0; self tapping; titanium; TiOB®	 4 047075 131877
3.138.26	cortical screw; Ø 3.5 x 26; fully threaded; head 5.0; self tapping; titanium; TiOB®	 4 047075 131884
3.138.28	cortical screw; Ø 3.5 x 28; fully threaded; head 5.0; self tapping; titanium; TiOB®	 4 047075 131891
3.138.30	cortical screw; Ø 3.5 x 30; fully threaded; head 5.0; self tapping; titanium; TiOB®	 4 047075 131907
3.138.32	cortical screw; Ø 3.5 x 32; fully threaded; head 5.0; self tapping; titanium; TiOB®	 4 047075 131914
3.138.34	cortical screw; Ø 3.5 x 34; fully threaded; head 5.0; self tapping; titanium; TiOB®	 4 047075 131921
3.138.36	cortical screw; Ø 3.5 x 36; fully threaded; head 5.0; self tapping; titanium; TiOB®	 4 047075 131938
3.138.38	cortical screw; Ø 3.5 x 38; fully threaded; head 5.0; self tapping; titanium; TiOB®	 4 047075 131945
3.138.40	cortical screw; Ø 3.5 x 40; fully threaded; head 5.0; self tapping; titanium; TiOB®	 4 047075 131952
3.138.42	cortical screw; Ø 3.5 x 42; fully threaded; head 5.0; self tapping; titanium; TiOB®	 4 047075 172610
3.138.44	cortical screw; Ø 3.5 x 44; fully threaded; head 5.0; self tapping; titanium; TiOB®	 4 047075 172627
3.138.46	cortical screw; Ø 3.5 x 46; fully threaded; head 5.0; self tapping; titanium; TiOB®	 4 047075 172634
3.138.48	cortical screw; Ø 3.5 x 48; fully threaded; head 5.0; self tapping; titanium; TiOB®	 4 047075 172641
3.138.50	cortical screw; Ø 3.5 x 50; fully threaded; head 5.0; self tapping; titanium; TiOB®	 4 047075 172658
Cortical screw 4.5 - on sale, only a few available. Please use the self-tapping alternative article		
3.150.10	cortical screw; Ø 4.5 x 10; fully threaded; titanium	 4 047075 091584
3.150.12	cortical screw; Ø 4.5 x 12; fully threaded; titanium	 4 047075 091638
3.150.14	cortical screw; Ø 4.5 x 14; fully threaded; titanium	 4 047075 091737
3.150.16	cortical screw; Ø 4.5 x 16; fully threaded; titanium	 4 047075 091645
3.150.18	cortical screw; Ø 4.5 x 18; fully threaded; titanium	 4 047075 091652
3.150.20	cortical screw; Ø 4.5 x 20; fully threaded; titanium	 4 047075 091560

Information

TiOB® is a trademark of Königsee Implantate GmbH registered in the EU countries, Switzerland and the USA. It is a surface treatment that brings optimized properties.



Königsee Implantate GmbH
OT Aschau | Am Sand 4
07426 Allendorf | Germany

Fon +49 36738 498-560
Fax +49 36738 498-569































Mail export@koenigsee-implantate.de

For further information please visit:
www.koenigsee-implantate.com

DaTi | Edition 02 | 2020-03
All pictured products are CE compliant.



















Cortical screws

Standard; titanium

Item no.	Item description	EAN
3.150.22	cortical screw; Ø 4.5 x 22; fully threaded; titanium	 4 047075 091720
3.150.24	cortical screw; Ø 4.5 x 24; fully threaded; titanium	 4 047075 091751
3.150.25	cortical screw; Ø 4.5 x 25; fully threaded; titanium	 4 047075 091768
3.150.26	cortical screw; Ø 4.5 x 26; fully threaded; titanium	 4 047075 091775
3.150.28	cortical screw; Ø 4.5 x 28; fully threaded; titanium	 4 047075 091782
3.150.30	cortical screw; Ø 4.5 x 30; fully threaded; titanium	 4 047075 091669
3.150.32	cortical screw; Ø 4.5 x 32; fully threaded; titanium	 4 047075 091805
3.150.34	cortical screw; Ø 4.5 x 34; fully threaded; titanium	 4 047075 091690
3.150.35	cortical screw; Ø 4.5 x 35; fully threaded; titanium	 4 047075 091881
3.150.36	cortical screw; Ø 4.5 x 36; fully threaded; titanium	 4 047075 091898
3.150.38	cortical screw; Ø 4.5 x 38; fully threaded; titanium	 4 047075 091799
3.150.40	cortical screw; Ø 4.5 x 40; fully threaded; titanium	 4 047075 091928
3.150.42	cortical screw; Ø 4.5 x 42; fully threaded; titanium	 4 047075 091812
3.150.44	cortical screw; Ø 4.5 x 44; fully threaded; titanium	 4 047075 091829
3.150.45	cortical screw; Ø 4.5 x 45; fully threaded; titanium	 4 047075 091836
3.150.46	cortical screw; Ø 4.5 x 46; fully threaded; titanium	 4 047075 091713
3.150.48	cortical screw; Ø 4.5 x 48; fully threaded; titanium	 4 047075 091911
3.150.50	cortical screw; Ø 4.5 x 50; fully threaded; titanium	 4 047075 091935
3.150.52	cortical screw; Ø 4.5 x 52; fully threaded; titanium	 4 047075 091942
3.150.54	cortical screw; Ø 4.5 x 54; fully threaded; titanium	 4 047075 091959
3.150.55	cortical screw; Ø 4.5 x 55; fully threaded; titanium	 4 047075 091966
3.150.56	cortical screw; Ø 4.5 x 56; fully threaded; titanium	 4 047075 091843
3.150.58	cortical screw; Ø 4.5 x 58; fully threaded; titanium	 4 047075 091850
3.150.60	cortical screw; Ø 4.5 x 60; fully threaded; titanium	 4 047075 091867
3.150.62	cortical screw; Ø 4.5 x 62; fully threaded; titanium	 4 047075 091874
3.150.64	cortical screw; Ø 4.5 x 64; fully threaded; titanium	 4 047075 092062
3.150.65	cortical screw; Ø 4.5 x 65; fully threaded; titanium	 4 047075 092079
3.150.66	cortical screw; Ø 4.5 x 66; fully threaded; titanium	 4 047075 091973
3.150.68	cortical screw; Ø 4.5 x 68; fully threaded; titanium	 4 047075 092093
3.150.70	cortical screw; Ø 4.5 x 70; fully threaded; titanium	 4 047075 091980
3.150.72	cortical screw; Ø 4.5 x 72; fully threaded; titanium	 4 047075 091997
3.150.74	cortical screw; Ø 4.5 x 74; fully threaded; titanium	 4 047075 092000
3.150.75	cortical screw; Ø 4.5 x 75; fully threaded; titanium	 4 047075 091904
3.150.76	cortical screw; Ø 4.5 x 76; fully threaded; titanium	 4 047075 092215

Cortical screws

Standard; titanium

Item no.	Item description	EAN
3.150.78	cortical screw; Ø 4.5 x 78; fully threaded; titanium	 4 047075 092109
3.150.80	cortical screw; Ø 4.5 x 80; fully threaded; titanium	 4 047075 092116
3.150.82	cortical screw; Ø 4.5 x 82; fully threaded; titanium	 4 047075 092123
3.150.85	cortical screw; Ø 4.5 x 85; fully threaded; titanium	 4 047075 092017
3.150.90	cortical screw; Ø 4.5 x 90; fully threaded; titanium	 4 047075 092024
3.150.95	cortical screw; Ø 4.5 x 95; fully threaded; titanium	 4 047075 092031
3.150.100	cortical screw; Ø 4.5 x 100; fully threaded; titanium	 4 047075 091591
3.150.105	cortical screw; Ø 4.5 x 105; fully threaded; titanium	 4 047075 091607
3.150.110	cortical screw; Ø 4.5 x 110; fully threaded; titanium	 4 047075 091614
3.150.115	cortical screw; Ø 4.5 x 115; fully threaded; titanium	 4 047075 091492
3.150.120	cortical screw; Ø 4.5 x 120; fully threaded; titanium	 4 047075 091515
3.150.125	cortical screw; Ø 4.5 x 125; fully threaded; titanium	 4 047075 091522
3.150.130	cortical screw; Ø 4.5 x 130; fully threaded; titanium	 4 047075 091706
3.150.135	cortical screw; Ø 4.5 x 135; fully threaded; titanium	 4 047075 091621
3.150.140	cortical screw; Ø 4.5 x 140; fully threaded; titanium	 4 047075 091744
Cortical screw 4.5 st		
3.152.12	cortical screw; Ø 4.5 x 12; fully threaded; self tapping; titanium	 4 047075 092154
3.152.14	cortical screw; Ø 4.5 x 14; fully threaded; self tapping; titanium	 4 047075 092338
3.152.16	cortical screw; Ø 4.5 x 16; fully threaded; self tapping; titanium	 4 047075 092260
3.152.18	cortical screw; Ø 4.5 x 18; fully threaded; self tapping; titanium	 4 047075 092277
3.152.20	cortical screw; Ø 4.5 x 20; fully threaded; self tapping; titanium	 4 047075 092192
3.152.22	cortical screw; Ø 4.5 x 22; fully threaded; self tapping; titanium	 4 047075 092208
3.152.24	cortical screw; Ø 4.5 x 24; fully threaded; self tapping; titanium	 4 047075 092222
3.152.26	cortical screw; Ø 4.5 x 26; fully threaded; self tapping; titanium	 4 047075 092239
3.152.28	cortical screw; Ø 4.5 x 28; fully threaded; self tapping; titanium	 4 047075 092376
3.152.30	cortical screw; Ø 4.5 x 30; fully threaded; self tapping; titanium	 4 047075 092383
3.152.32	cortical screw; Ø 4.5 x 32; fully threaded; self tapping; titanium	 4 047075 092284
3.152.34	cortical screw; Ø 4.5 x 34; fully threaded; self tapping; titanium	 4 047075 092406
3.152.35	cortical screw; Ø 4.5 x 35; fully threaded; self tapping; titanium	 4 047075 121397
3.152.36	cortical screw; Ø 4.5 x 36; fully threaded; self tapping; titanium	 4 047075 092291
3.152.38	cortical screw; Ø 4.5 x 38; fully threaded; self tapping; titanium	 4 047075 092307
3.152.40	cortical screw; Ø 4.5 x 40; fully threaded; self tapping; titanium	 4 047075 092314
3.152.42	cortical screw; Ø 4.5 x 42; fully threaded; self tapping; titanium	 4 047075 092253
3.152.44	cortical screw; Ø 4.5 x 44; fully threaded; self tapping; titanium	 4 047075 092529

Cortical screws

Standard; titanium

Item no.	Item description	EAN
3.152.45	cortical screw; Ø 4.5 x 45; fully threaded; self tapping; titanium	4 047075 092413
3.152.46	cortical screw; Ø 4.5 x 46; fully threaded; self tapping; titanium	4 047075 092420
3.152.48	cortical screw; Ø 4.5 x 48; fully threaded; self tapping; titanium	4 047075 092437
3.152.50	cortical screw; Ø 4.5 x 50; fully threaded; self tapping; titanium	4 047075 092444
3.152.52	cortical screw; Ø 4.5 x 52; fully threaded; self tapping; titanium	4 047075 092321
3.152.54	cortical screw; Ø 4.5 x 54; fully threaded; self tapping; titanium	4 047075 092468
3.152.55	cortical screw; Ø 4.5 x 55; fully threaded; self tapping; titanium	4 047075 092352
3.152.56	cortical screw; Ø 4.5 x 56; fully threaded; self tapping; titanium	4 047075 092369
3.152.58	cortical screw; Ø 4.5 x 58; fully threaded; self tapping; titanium	4 047075 092350
3.152.60	cortical screw; Ø 4.5 x 60; fully threaded; self tapping; titanium	4 047075 092367
3.152.62	cortical screw; Ø 4.5 x 62; fully threaded; self tapping; titanium	4 047075 092451
3.152.64	cortical screw; Ø 4.5 x 64; fully threaded; self tapping; titanium	4 047075 092381
3.152.65	cortical screw; Ø 4.5 x 65; fully threaded; self tapping; titanium	4 047075 092475
3.152.66	cortical screw; Ø 4.5 x 66; fully threaded; self tapping; titanium	4 047075 092482
3.152.68	cortical screw; Ø 4.5 x 68; fully threaded; self tapping; titanium	4 047075 092499
3.152.70	cortical screw; Ø 4.5 x 70; fully threaded; self tapping; titanium	4 047075 092305
3.152.72	cortical screw; Ø 4.5 x 72; fully threaded; self tapping; titanium	4 047075 092390
3.152.74	cortical screw; Ø 4.5 x 74; fully threaded; self tapping; titanium	4 047075 092703
3.152.75	cortical screw; Ø 4.5 x 75; fully threaded; self tapping; titanium	4 047075 092598
3.152.76	cortical screw; Ø 4.5 x 76; fully threaded; self tapping; titanium	4 047075 092604
3.152.78	cortical screw; Ø 4.5 x 78; fully threaded; self tapping; titanium	4 047075 092611
3.152.80	cortical screw; Ø 4.5 x 80; fully threaded; self tapping; titanium	4 047075 092512
3.152.85	cortical screw; Ø 4.5 x 85; fully threaded; self tapping; titanium	4 047075 092642
3.152.90	cortical screw; Ø 4.5 x 90; fully threaded; self tapping; titanium	4 047075 092536
3.152.95	cortical screw; Ø 4.5 x 95; fully threaded; self tapping; titanium	4 047075 092543
3.152.100	cortical screw; Ø 4.5 x 100; fully threaded; self tapping; titanium	4 047075 092055
3.152.105	cortical screw; Ø 4.5 x 105; fully threaded; self tapping; titanium	4 047075 092246
3.152.110	cortical screw; Ø 4.5 x 110; fully threaded; self tapping; titanium	4 047075 092130
3.152.115	cortical screw; Ø 4.5 x 115; fully threaded; self tapping; titanium	4 047075 092147
3.152.120	cortical screw; Ø 4.5 x 120; fully threaded; self tapping; titanium	4 047075 092161
3.152.125	cortical screw; Ø 4.5 x 125; fully threaded; self tapping; titanium	4 047075 092178
3.152.130	cortical screw; Ø 4.5 x 130; fully threaded; self tapping; titanium	4 047075 092185
3.152.135	cortical screw; Ø 4.5 x 135; fully threaded; self tapping; titanium	4 047075 092086
3.152.140	cortical screw; Ø 4.5 x 140; fully threaded; self tapping; titanium	4 047075 092345

Cortical screws

Standard; stainless steel



Item no. 2.100.20



Item no. 2.110.20



Item no. 2.120.20



Item no. 2.130.20



Item no. 2.132.20



Item no. 2.150.20



Item no. 2.152.30

Item no.	Item description	EAN
----------	------------------	-----

Cortical screw 1.5 st

2.100.06	cortical screw; Ø 1.5 x 6; fully threaded; self tapping; stainless steel	4 047075 067183
2.100.07	cortical screw; Ø 1.5 x 7; fully threaded; self tapping; stainless steel	4 047075 067190
2.100.08	cortical screw; Ø 1.5 x 8; fully threaded; self tapping; stainless steel	4 047075 067206
2.100.09	cortical screw; Ø 1.5 x 9; fully threaded; self tapping; stainless steel	4 047075 067015
2.100.10	cortical screw; Ø 1.5 x 10; fully threaded; self tapping; stainless steel	4 047075 067442
2.100.11	cortical screw; Ø 1.5 x 11; fully threaded; self tapping; stainless steel	4 047075 067336
2.100.12	cortical screw; Ø 1.5 x 12; fully threaded; self tapping; stainless steel	4 047075 067343
2.100.13	cortical screw; Ø 1.5 x 13; fully threaded; self tapping; stainless steel	4 047075 067350
2.100.14	cortical screw; Ø 1.5 x 14; fully threaded; self tapping; stainless steel	4 047075 067213
2.100.15	cortical screw; Ø 1.5 x 15; fully threaded; self tapping; stainless steel	4 047075 067381
2.100.16	cortical screw; Ø 1.5 x 16; fully threaded; self tapping; stainless steel	4 047075 067398
2.100.18	cortical screw; Ø 1.5 x 18; fully threaded; self tapping; stainless steel	4 047075 067268
2.100.20	cortical screw; Ø 1.5 x 20; fully threaded; self tapping; stainless steel	4 047075 067466
2.100.22	cortical screw; Ø 1.5 x 22; fully threaded; self tapping; stainless steel	4 047075 067367
2.100.24	cortical screw; Ø 1.5 x 24; fully threaded; self tapping; stainless steel	4 047075 067374

Cortical screw 2.0 st

2.110.06	cortical screw; Ø 2 x 6; fully threaded; self tapping; stainless steel	4 047075 067404
2.110.08	cortical screw; Ø 2 x 8; fully threaded; self tapping; stainless steel	4 047075 067411
2.110.10	cortical screw; Ø 2 x 10; fully threaded; self tapping; stainless steel	4 047075 067428
2.110.12	cortical screw; Ø 2 x 12; fully threaded; self tapping; stainless steel	4 047075 067305
2.110.14	cortical screw; Ø 2 x 14; fully threaded; self tapping; stainless steel	4 047075 067633
2.110.15	cortical screw; Ø 2 x 15; fully threaded; self tapping; stainless steel	4 047075 067640
2.110.16	cortical screw; Ø 2 x 16; fully threaded; self tapping; stainless steel	4 047075 067534
2.110.18	cortical screw; Ø 2 x 18; fully threaded; self tapping; stainless steel	4 047075 067664
2.110.20	cortical screw; Ø 2 x 20; fully threaded; self tapping; stainless steel	4 047075 067558
2.110.22	cortical screw; Ø 2 x 22; fully threaded; self tapping; stainless steel	4 047075 067565























Cortical screws

Standard; stainless steel

Item no.	Item description	EAN
2.110.24	cortical screw; Ø 2 x 24; fully threaded; self tapping; stainless steel	 4 047075 067572
2.110.26	cortical screw; Ø 2 x 26; fully threaded; self tapping; stainless steel	 4 047075 067473
2.110.28	cortical screw; Ø 2 x 28; fully threaded; self tapping; stainless steel	 4 047075 067763
2.110.30	cortical screw; Ø 2 x 30; fully threaded; self tapping; stainless steel	 4 047075 067770
2.110.32	cortical screw; Ø 2 x 32; fully threaded; self tapping; stainless steel	 4 047075 067671
2.110.34	cortical screw; Ø 2 x 34; fully threaded; self tapping; stainless steel	 4 047075 067688
2.110.36	cortical screw; Ø 2 x 36; fully threaded; self tapping; stainless steel	 4 047075 067589
2.110.38	cortical screw; Ø 2 x 38; fully threaded; self tapping; stainless steel	 4 047075 067596
2.110.40	cortical screw; Ø 2 x 40; fully threaded; self tapping; stainless steel	 4 047075 067701
Cortical screw 2.7 st		
2.120.06	cortical screw; Ø 2.7 x 6; fully threaded; self tapping; stainless steel	 4 047075 067756
2.120.08	cortical screw; Ø 2.7 x 8; fully threaded; self tapping; stainless steel	 4 047075 067886
2.120.10	cortical screw; Ø 2.7 x 10; fully threaded; self tapping; stainless steel	 4 047075 067893
2.120.12	cortical screw; Ø 2.7 x 12; fully threaded; self tapping; stainless steel	 4 047075 067787
2.120.14	cortical screw; Ø 2.7 x 14; fully threaded; self tapping; stainless steel	 4 047075 068005
2.120.16	cortical screw; Ø 2.7 x 16; fully threaded; self tapping; stainless steel	 4 047075 067862
2.120.18	cortical screw; Ø 2.7 x 18; fully threaded; self tapping; stainless steel	 4 047075 067879
2.120.20	cortical screw; Ø 2.7 x 20; fully threaded; self tapping; stainless steel	 4 047075 068029
2.120.22	cortical screw; Ø 2.7 x 22; fully threaded; self tapping; stainless steel	 4 047075 067909
2.120.24	cortical screw; Ø 2.7 x 24; fully threaded; self tapping; stainless steel	 4 047075 067916
2.120.26	cortical screw; Ø 2.7 x 26; fully threaded; self tapping; stainless steel	 4 047075 067923
2.120.28	cortical screw; Ø 2.7 x 28; fully threaded; self tapping; stainless steel	 4 047075 067817
2.120.30	cortical screw; Ø 2.7 x 30; fully threaded; self tapping; stainless steel	 4 047075 068142
2.120.32	cortical screw; Ø 2.7 x 32; fully threaded; self tapping; stainless steel	 4 047075 068036
2.120.34	cortical screw; Ø 2.7 x 34; fully threaded; self tapping; stainless steel	 4 047075 068043
2.120.36	cortical screw; Ø 2.7 x 36; fully threaded; self tapping; stainless steel	 4 047075 068050
2.120.38	cortical screw; Ø 2.7 x 38; fully threaded; self tapping; stainless steel	 4 047075 067930
2.120.40	cortical screw; Ø 2.7 x 40; fully threaded; self tapping; stainless steel	 4 047075 068081
2.120.42	cortical screw; Ø 2.7 x 42; fully threaded; self tapping; stainless steel	 4 047075 068098
2.120.44	cortical screw; Ø 2.7 x 44; fully threaded; self tapping; stainless steel	 4 047075 067978
2.120.46	cortical screw; Ø 2.7 x 46; fully threaded; self tapping; stainless steel	 4 047075 067985
2.120.48	cortical screw; Ø 2.7 x 48; fully threaded; self tapping; stainless steel	 4 047075 067992
2.120.50	cortical screw; Ø 2.7 x 50; fully threaded; self tapping; stainless steel	 4 047075 068166
Cortical screw 3.5 - on sale, only a few available. Please use the self-tapping alternative article		
2.130.06	cortical screw; Ø 3.5 x 6; fully threaded; stainless steel	 4 047075 068388

Cortical screws

Standard; stainless steel

Item no.	Item description	EAN
2.130.08	cortical screw; Ø 3.5 x 8; fully threaded; stainless steel	 4 047075 068395
2.130.10	cortical screw; Ø 3.5 x 10; fully threaded; stainless steel	 4 047075 068272
2.130.12	cortical screw; Ø 3.5 x 12; fully threaded; stainless steel	 4 047075 068197
2.130.14	cortical screw; Ø 3.5 x 14; fully threaded; stainless steel	 4 047075 068425
2.130.16	cortical screw; Ø 3.5 x 16; fully threaded; stainless steel	 4 047075 068319
2.130.18	cortical screw; Ø 3.5 x 18; fully threaded; stainless steel	 4 047075 068463
2.130.20	cortical screw; Ø 3.5 x 20; fully threaded; stainless steel	 4 047075 068470
2.130.22	cortical screw; Ø 3.5 x 22; fully threaded; stainless steel	 4 047075 068333
2.130.24	cortical screw; Ø 3.5 x 24; fully threaded; stainless steel	 4 047075 068562
2.130.26	cortical screw; Ø 3.5 x 26; fully threaded; stainless steel	 4 047075 068579
2.130.28	cortical screw; Ø 3.5 x 28; fully threaded; stainless steel	 4 047075 068586
2.130.30	cortical screw; Ø 3.5 x 30; fully threaded; stainless steel	 4 047075 068449
2.130.32	cortical screw; Ø 3.5 x 32; fully threaded; stainless steel	 4 047075 068456
2.130.34	cortical screw; Ø 3.5 x 34; fully threaded; stainless steel	 4 047075 068623
2.130.36	cortical screw; Ø 3.5 x 36; fully threaded; stainless steel	 4 047075 068630
2.130.38	cortical screw; Ø 3.5 x 38; fully threaded; stainless steel	 4 047075 068487
2.130.40	cortical screw; Ø 3.5 x 40; fully threaded; stainless steel	 4 047075 068494
2.130.42	cortical screw; Ø 3.5 x 42; fully threaded; stainless steel	 4 047075 068500
2.130.44	cortical screw; Ø 3.5 x 44; fully threaded; stainless steel	 4 047075 068517
2.130.45	cortical screw; Ø 3.5 x 45; fully threaded; stainless steel	 4 047075 068357
2.130.46	cortical screw; Ø 3.5 x 46; fully threaded; stainless steel	 4 047075 068616
2.130.48	cortical screw; Ø 3.5 x 48; fully threaded; stainless steel	 4 047075 068807
2.130.50	cortical screw; Ø 3.5 x 50; fully threaded; stainless steel	 4 047075 068814
2.130.52	cortical screw; Ø 3.5 x 52; fully threaded; stainless steel	 4 047075 068647
2.130.55	cortical screw; Ø 3.5 x 55; fully threaded; stainless steel	 4 047075 068654
2.130.60	cortical screw; Ø 3.5 x 60; fully threaded; stainless steel	 4 047075 068661
2.130.65	cortical screw; Ø 3.5 x 65; fully threaded; stainless steel	 4 047075 068678
2.130.70	cortical screw; Ø 3.5 x 70; fully threaded; stainless steel	 4 047075 068524
2.130.75	cortical screw; Ø 3.5 x 75; fully threaded; stainless steel	 4 047075 068531
2.130.80	cortical screw; Ø 3.5 x 80; fully threaded; stainless steel	 4 047075 068708
2.130.85	cortical screw; Ø 3.5 x 85; fully threaded; stainless steel	 4 047075 068715
2.130.90	cortical screw; Ø 3.5 x 90; fully threaded; stainless steel	 4 047075 068722
2.130.95	cortical screw; Ø 3.5 x 95; fully threaded; stainless steel	 4 047075 068555
2.130.100	cortical screw; Ø 3.5 x 100; fully threaded; stainless steel	 4 047075 068289
2.130.105	cortical screw; Ø 3.5 x 105; fully threaded; stainless steel	 4 047075 068296

Cortical screws

Standard; stainless steel

Item no.	Item description	EAN
2.130.110	cortical screw; Ø 3.5 x 110; fully threaded; stainless steel	4 047075 068302
2.130.115	cortical screw; Ø 3.5 x 115; fully threaded; stainless steel	4 047075 068180
2.130.120	cortical screw; Ø 3.5 x 120; fully threaded; stainless steel	4 047075 068364
2.130.125	cortical screw; Ø 3.5 x 125; fully threaded; stainless steel	4 047075 068548
2.130.130	cortical screw; Ø 3.5 x 130; fully threaded; stainless steel	4 047075 068401
2.130.135	cortical screw; Ø 3.5 x 135; fully threaded; stainless steel	4 047075 068418
2.130.140	cortical screw; Ø 3.5 x 140; fully threaded; stainless steel	4 047075 068432
Cortical screw 3.5 st		
2.132.08	cortical screw; Ø 3.5 x 8; fully threaded; self tapping; stainless steel	4 047075 068869
2.132.10	cortical screw; Ø 3.5 x 10; fully threaded; self tapping; stainless steel	4 047075 068876
2.132.12	cortical screw; Ø 3.5 x 12; fully threaded; self tapping; stainless steel	4 047075 068920
2.132.14	cortical screw; Ø 3.5 x 14; fully threaded; self tapping; stainless steel	4 047075 068753
2.132.16	cortical screw; Ø 3.5 x 16; fully threaded; self tapping; stainless steel	4 047075 068777
2.132.18	cortical screw; Ø 3.5 x 18; fully threaded; self tapping; stainless steel	4 047075 068593
2.132.20	cortical screw; Ø 3.5 x 20; fully threaded; self tapping; stainless steel	4 047075 068809
2.132.22	cortical screw; Ø 3.5 x 22; fully threaded; self tapping; stainless steel	4 047075 069095
2.132.24	cortical screw; Ø 3.5 x 24; fully threaded; self tapping; stainless steel	4 047075 069101
2.132.26	cortical screw; Ø 3.5 x 26; fully threaded; self tapping; stainless steel	4 047075 068944
2.132.28	cortical screw; Ø 3.5 x 28; fully threaded; self tapping; stainless steel	4 047075 068951
2.132.30	cortical screw; Ø 3.5 x 30; fully threaded; self tapping; stainless steel	4 047075 068968
2.132.32	cortical screw; Ø 3.5 x 32; fully threaded; self tapping; stainless steel	4 047075 068975
2.132.34	cortical screw; Ø 3.5 x 34; fully threaded; self tapping; stainless steel	4 047075 068784
2.132.36	cortical screw; Ø 3.5 x 36; fully threaded; self tapping; stainless steel	4 047075 068791
2.132.38	cortical screw; Ø 3.5 x 38; fully threaded; self tapping; stainless steel	4 047075 069002
2.132.40	cortical screw; Ø 3.5 x 40; fully threaded; self tapping; stainless steel	4 047075 069019
2.132.42	cortical screw; Ø 3.5 x 42; fully threaded; self tapping; stainless steel	4 047075 068821
2.132.44	cortical screw; Ø 3.5 x 44; fully threaded; self tapping; stainless steel	4 047075 068838
2.132.45	cortical screw; Ø 3.5 x 45; fully threaded; self tapping; stainless steel	4 047075 069125
2.132.46	cortical screw; Ø 3.5 x 46; fully threaded; self tapping; stainless steel	4 047075 069132
2.132.48	cortical screw; Ø 3.5 x 48; fully threaded; self tapping; stainless steel	4 047075 069149
2.132.50	cortical screw; Ø 3.5 x 50; fully threaded; self tapping; stainless steel	4 047075 068982
2.132.55	cortical screw; Ø 3.5 x 55; fully threaded; self tapping; stainless steel	4 047075 068999
2.132.60	cortical screw; Ø 3.5 x 60; fully threaded; self tapping; stainless steel	4 047075 069163
2.132.65	cortical screw; Ø 3.5 x 65; fully threaded; self tapping; stainless steel	4 047075 069170
2.132.68	cortical screw; Ø 3.5 x 68; fully threaded; self tapping; stainless steel	4 047075 069026











Cortical screws

Standard; stainless steel

Item no.	Item description	EAN
2.132.70	cortical screw; Ø 3.5 x 70; fully threaded; self tapping; stainless steel	4 047075 069033
2.132.75	cortical screw; Ø 3.5 x 75; fully threaded; self tapping; stainless steel	4 047075 069040
2.132.80	cortical screw; Ø 3.5 x 80; fully threaded; self tapping; stainless steel	4 047075 069057
2.132.85	cortical screw; Ø 3.5 x 85; fully threaded; self tapping; stainless steel	4 047075 069064
2.132.90	cortical screw; Ø 3.5 x 90; fully threaded; self tapping; stainless steel	4 047075 068883
2.132.95	cortical screw; Ø 3.5 x 95; fully threaded; self tapping; stainless steel	4 047075 068890
2.132.100	cortical screw; Ø 3.5 x 100; fully threaded; self tapping; stainless steel	4 047075 068685
2.132.105	cortical screw; Ø 3.5 x 105; fully threaded; self tapping; stainless steel	4 047075 068692
2.132.110	cortical screw; Ø 3.5 x 110; fully threaded; self tapping; stainless steel	4 047075 068906
2.132.115	cortical screw; Ø 3.5 x 115; fully threaded; self tapping; stainless steel	4 047075 068913
2.132.120	cortical screw; Ø 3.5 x 120; fully threaded; self tapping; stainless steel	4 047075 068937
2.132.125	cortical screw; Ø 3.5 x 125; fully threaded; self tapping; stainless steel	4 047075 068739
2.132.135	cortical screw; Ø 3.5 x 135; fully threaded; self tapping; stainless steel	4 047075 068746
2.132.140	cortical screw; Ø 3.5 x 140; fully threaded; self tapping; stainless steel	4 047075 068760
Cortical screw 4.5 - on sale, only a few available. Please use the self-tapping alternative article		
2.150.12	cortical screw; Ø 4.5 x 12; fully threaded; stainless steel	4 047075 070664
2.150.14	cortical screw; Ø 4.5 x 14; fully threaded; stainless steel	4 047075 070756
2.150.16	cortical screw; Ø 4.5 x 16; fully threaded; stainless steel	4 047075 070671
2.150.18	cortical screw; Ø 4.5 x 18; fully threaded; stainless steel	4 047075 070688
2.150.20	cortical screw; Ø 4.5 x 20; fully threaded; stainless steel	4 047075 070565
2.150.22	cortical screw; Ø 4.5 x 22; fully threaded; stainless steel	4 047075 070701
2.150.24	cortical screw; Ø 4.5 x 24; fully threaded; stainless steel	4 047075 070596
2.150.25	cortical screw; Ø 4.5 x 25; fully threaded; stainless steel	4 047075 070787
2.150.26	cortical screw; Ø 4.5 x 26; fully threaded; stainless steel	4 047075 070794
2.150.28	cortical screw; Ø 4.5 x 28; fully threaded; stainless steel	4 047075 070695
2.150.30	cortical screw; Ø 4.5 x 30; fully threaded; stainless steel	4 047075 070817
2.150.32	cortical screw; Ø 4.5 x 32; fully threaded; stainless steel	4 047075 070718
2.150.34	cortical screw; Ø 4.5 x 34; fully threaded; stainless steel	4 047075 070725
2.150.35	cortical screw; Ø 4.5 x 35; fully threaded; stainless steel	4 047075 070732
2.150.36	cortical screw; Ø 4.5 x 36; fully threaded; stainless steel	4 047075 070633
2.150.38	cortical screw; Ø 4.5 x 38; fully threaded; stainless steel	4 047075 070916
2.150.40	cortical screw; Ø 4.5 x 40; fully threaded; stainless steel	4 047075 070824
2.150.42	cortical screw; Ø 4.5 x 42; fully threaded; stainless steel	4 047075 070831
2.150.44	cortical screw; Ø 4.5 x 44; fully threaded; stainless steel	4 047075 070848
2.150.45	cortical screw; Ø 4.5 x 45; fully threaded; stainless steel	4 047075 070749

















Cortical screws

Standard; stainless steel

Item no.	Item description	EAN
2.150.46	cortical screw; Ø 4.5 x 46; fully threaded; stainless steel	 4 047075 070862
2.150.48	cortical screw; Ø 4.5 x 48; fully threaded; stainless steel	 4 047075 070770
2.150.50	cortical screw; Ø 4.5 x 50; fully threaded; stainless steel	 4 047075 070930
2.150.52	cortical screw; Ø 4.5 x 52; fully threaded; stainless steel	 4 047075 070947
2.150.54	cortical screw; Ø 4.5 x 54; fully threaded; stainless steel	 4 047075 070855
2.150.55	cortical screw; Ø 4.5 x 55; fully threaded; stainless steel	 4 047075 070978
2.150.56	cortical screw; Ø 4.5 x 56; fully threaded; stainless steel	 4 047075 070985
2.150.58	cortical screw; Ø 4.5 x 58; fully threaded; stainless steel	 4 047075 070886
2.150.60	cortical screw; Ø 4.5 x 60; fully threaded; stainless steel	 4 047075 070893
2.150.62	cortical screw; Ø 4.5 x 62; fully threaded; stainless steel	 4 047075 070800
2.150.64	cortical screw; Ø 4.5 x 64; fully threaded; stainless steel	 4 047075 070961
2.150.65	cortical screw; Ø 4.5 x 65; fully threaded; stainless steel	 4 047075 071098
2.150.66	cortical screw; Ø 4.5 x 66; fully threaded; stainless steel	 4 047075 070992
2.150.68	cortical screw; Ø 4.5 x 68; fully threaded; stainless steel	 4 047075 071005
2.150.70	cortical screw; Ø 4.5 x 70; fully threaded; stainless steel	 4 047075 071012
2.150.72	cortical screw; Ø 4.5 x 72; fully threaded; stainless steel	 4 047075 070909
2.150.74	cortical screw; Ø 4.5 x 74; fully threaded; stainless steel	 4 047075 071036
2.150.75	cortical screw; Ø 4.5 x 75; fully threaded; stainless steel	 4 047075 070923
2.150.76	cortical screw; Ø 4.5 x 76; fully threaded; stainless steel	 4 047075 071111
2.150.78	cortical screw; Ø 4.5 x 78; fully threaded; stainless steel	 4 047075 071128
2.150.80	cortical screw; Ø 4.5 x 80; fully threaded; stainless steel	 4 047075 071029
2.150.85	cortical screw; Ø 4.5 x 85; fully threaded; stainless steel	 4 047075 071159
2.150.90	cortical screw; Ø 4.5 x 90; fully threaded; stainless steel	 4 047075 071166
2.150.95	cortical screw; Ø 4.5 x 95; fully threaded; stainless steel	 4 047075 071043
2.150.100	cortical screw; Ø 4.5 x 100; fully threaded; stainless steel	 4 047075 070619
2.150.105	cortical screw; Ø 4.5 x 105; fully threaded; stainless steel	 4 047075 070626
2.150.110	cortical screw; Ø 4.5 x 110; fully threaded; stainless steel	 4 047075 070527
2.150.120	cortical screw; Ø 4.5 x 120; fully threaded; stainless steel	 4 047075 070541
2.150.125	cortical screw; Ø 4.5 x 125; fully threaded; stainless steel	 4 047075 070558
2.150.130	cortical screw; Ø 4.5 x 130; fully threaded; stainless steel	 4 047075 070480
2.150.135	cortical screw; Ø 4.5 x 135; fully threaded; stainless steel	 4 047075 070640
2.150.140	cortical screw; Ø 4.5 x 140; fully threaded; stainless steel	 4 047075 070763
Cortical screw 4.5 st		
2.152.10	cortical screw; Ø 4.5 x 10; fully threaded; self tapping; stainless steel	 4 047075 071074
2.152.12	cortical screw; Ø 4.5 x 12; fully threaded; self tapping; stainless steel	 4 047075 071197

















Cortical screws

Standard; stainless steel

Item no.	Item description	EAN
2.152.14	cortical screw; Ø 4.5 x 14; fully threaded; self tapping; stainless steel	 4 047075 071289
2.152.16	cortical screw; Ø 4.5 x 16; fully threaded; self tapping; stainless steel	 4 047075 071210
2.152.18	cortical screw; Ø 4.5 x 18; fully threaded; self tapping; stainless steel	 4 047075 071319
2.152.20	cortical screw; Ø 4.5 x 20; fully threaded; self tapping; stainless steel	 4 047075 071234
2.152.22	cortical screw; Ø 4.5 x 22; fully threaded; self tapping; stainless steel	 4 047075 071241
2.152.24	cortical screw; Ø 4.5 x 24; fully threaded; self tapping; stainless steel	 4 047075 071258
2.152.26	cortical screw; Ø 4.5 x 26; fully threaded; self tapping; stainless steel	 4 047075 071135
2.152.28	cortical screw; Ø 4.5 x 28; fully threaded; self tapping; stainless steel	 4 047075 071432
2.152.30	cortical screw; Ø 4.5 x 30; fully threaded; self tapping; stainless steel	 4 047075 071326
2.152.32	cortical screw; Ø 4.5 x 32; fully threaded; self tapping; stainless steel	 4 047075 071333
2.152.34	cortical screw; Ø 4.5 x 34; fully threaded; self tapping; stainless steel	 4 047075 071340
2.152.35	cortical screw; Ø 4.5 x 35; fully threaded; self tapping; stainless steel	 4 047075 071265
2.152.36	cortical screw; Ø 4.5 x 36; fully threaded; self tapping; stainless steel	 4 047075 071371
2.152.38	cortical screw; Ø 4.5 x 38; fully threaded; self tapping; stainless steel	 4 047075 071388
2.152.40	cortical screw; Ø 4.5 x 40; fully threaded; self tapping; stainless steel	 4 047075 071272
2.152.42	cortical screw; Ø 4.5 x 42; fully threaded; self tapping; stainless steel	 4 047075 071456
2.152.44	cortical screw; Ø 4.5 x 44; fully threaded; self tapping; stainless steel	 4 047075 071357
2.152.45	cortical screw; Ø 4.5 x 45; fully threaded; self tapping; stainless steel	 4 047075 071364
2.152.46	cortical screw; Ø 4.5 x 46; fully threaded; self tapping; stainless steel	 4 047075 071470
2.152.48	cortical screw; Ø 4.5 x 48; fully threaded; self tapping; stainless steel	 4 047075 071395
2.152.50	cortical screw; Ø 4.5 x 50; fully threaded; self tapping; stainless steel	 4 047075 071401
2.152.52	cortical screw; Ø 4.5 x 52; fully threaded; self tapping; stainless steel	 4 047075 071418
2.152.54	cortical screw; Ø 4.5 x 54; fully threaded; self tapping; stainless steel	 4 047075 071302
2.152.55	cortical screw; Ø 4.5 x 55; fully threaded; self tapping; stainless steel	 4 047075 071593
2.152.56	cortical screw; Ø 4.5 x 56; fully threaded; self tapping; stainless steel	 4 047075 071487
2.152.58	cortical screw; Ø 4.5 x 58; fully threaded; self tapping; stainless steel	 4 047075 071494
2.152.60	cortical screw; Ø 4.5 x 60; fully threaded; self tapping; stainless steel	 4 047075 071500
2.152.62	cortical screw; Ø 4.5 x 62; fully threaded; self tapping; stainless steel	 4 047075 071425
2.152.64	cortical screw; Ø 4.5 x 64; fully threaded; self tapping; stainless steel	 4 047075 071531
2.152.65	cortical screw; Ø 4.5 x 65; fully threaded; self tapping; stainless steel	 4 047075 071548
2.152.66	cortical screw; Ø 4.5 x 66; fully threaded; self tapping; stainless steel	 4 047075 071449
2.152.68	cortical screw; Ø 4.5 x 68; fully threaded; self tapping; stainless steel	 4 047075 071647
2.152.70	cortical screw; Ø 4.5 x 70; fully threaded; self tapping; stainless steel	 4 047075 071784
2.152.72	cortical screw; Ø 4.5 x 72; fully threaded; self tapping; stainless steel	 4 047075 071661
2.152.74	cortical screw; Ø 4.5 x 74; fully threaded; self tapping; stainless steel	 4 047075 071678

Cortical screws

Standard; stainless steel

Item no.	Item description	EAN
2.152.75	cortical screw; Ø 4.5 x 75; fully threaded; self tapping; stainless steel	 4 ⁰ 047075 ⁰ 071685 ¹
2.152.76	cortical screw; Ø 4.5 x 76; fully threaded; self tapping; stainless steel	 4 ⁰ 047075 ⁰ 071586 ¹
2.152.78	cortical screw; Ø 4.5 x 78; fully threaded; self tapping; stainless steel	 4 ⁰ 047075 ⁰ 071722 ¹
2.152.80	cortical screw; Ø 4.5 x 80; fully threaded; self tapping; stainless steel	 4 ⁰ 047075 ⁰ 071609 ¹
2.152.85	cortical screw; Ø 4.5 x 85; fully threaded; self tapping; stainless steel	 4 ⁰ 047075 ⁰ 065097 ¹
2.152.90	cortical screw; Ø 4.5 x 90; fully threaded; self tapping; stainless steel	 4 ⁰ 047075 ⁰ 065226 ¹
2.152.95	cortical screw; Ø 4.5 x 95; fully threaded; self tapping; stainless steel	 4 ⁰ 047075 ⁰ 065127 ¹
2.152.100	cortical screw; Ø 4.5 x 100; fully threaded; self tapping; stainless steel	 4 ⁰ 047075 ⁰ 070954 ¹
2.152.105	cortical screw; Ø 4.5 x 105; fully threaded; self tapping; stainless steel	 4 ⁰ 047075 ⁰ 071142 ¹
2.152.110	cortical screw; Ø 4.5 x 110; fully threaded; self tapping; stainless steel	 4 ⁰ 047075 ⁰ 071173 ¹
2.152.115	cortical screw; Ø 4.5 x 115; fully threaded; self tapping; stainless steel	 4 ⁰ 047075 ⁰ 071180 ¹
2.152.120	cortical screw; Ø 4.5 x 120; fully threaded; self tapping; stainless steel	 4 ⁰ 047075 ⁰ 071203 ¹
2.152.125	cortical screw; Ø 4.5 x 125; fully threaded; self tapping; stainless steel	 4 ⁰ 047075 ⁰ 071081 ¹
2.152.130	cortical screw; Ø 4.5 x 130; fully threaded; self tapping; stainless steel	 4 ⁰ 047075 ⁰ 071227 ¹
2.152.135	cortical screw; Ø 4.5 x 135; fully threaded; self tapping; stainless steel	 4 ⁰ 047075 ⁰ 071104 ¹
2.152.140	cortical screw; Ø 4.5 x 140; fully threaded; self tapping; stainless steel	 4 ⁰ 047075 ⁰ 071296 ¹

Cancellous screws

Standard; titanium



Item no. 2.230.20



Item no. 3.232.18



Item no. 3.140.30



Item no. 3.145.30



Item no. 3.183.60



Item no. 3.170.70



Item no. 3.180.70



Item no. 3.190.70





























Item no.	Item description	EAN
----------	------------------	-----

Cancellous screw 3.5

3.230.10	cancellous screw; Ø 3.5 x 10; fully threaded; titanium	4 047075 094707
3.230.12	cancellous screw; Ø 3.5 x 12; fully threaded; titanium	4 047075 094608
3.230.14	cancellous screw; Ø 3.5 x 14; fully threaded; titanium	4 047075 094790
3.230.16	cancellous screw; Ø 3.5 x 16; fully threaded; titanium	4 047075 094806
3.230.18	cancellous screw; Ø 3.5 x 18; fully threaded; titanium	4 047075 094691
3.230.20	cancellous screw; Ø 3.5 x 20; fully threaded; titanium	4 047075 094820
3.230.22	cancellous screw; Ø 3.5 x 22; fully threaded; titanium	4 047075 094714
3.230.24	cancellous screw; Ø 3.5 x 24; fully threaded; titanium	4 047075 094721
3.230.26	cancellous screw; Ø 3.5 x 26; fully threaded; titanium	4 047075 094738
3.230.28	cancellous screw; Ø 3.5 x 28; fully threaded; titanium	4 047075 094639
3.230.30	cancellous screw; Ø 3.5 x 30; fully threaded; titanium	4 047075 094943
3.230.32	cancellous screw; Ø 3.5 x 32; fully threaded; titanium	4 047075 094837
3.230.34	cancellous screw; Ø 3.5 x 34; fully threaded; titanium	4 047075 094844
3.230.35	cancellous screw; Ø 3.5 x 35; fully threaded; titanium	4 047075 094851
3.230.36	cancellous screw; Ø 3.5 x 36; fully threaded; titanium	4 047075 094745
3.230.38	cancellous screw; Ø 3.5 x 38; fully threaded; titanium	4 047075 094752
3.230.40	cancellous screw; Ø 3.5 x 40; fully threaded; titanium	4 047075 094769
3.230.42	cancellous screw; Ø 3.5 x 42; fully threaded; titanium	4 047075 094776
3.230.44	cancellous screw; Ø 3.5 x 44; fully threaded; titanium	4 047075 094783
3.230.45	cancellous screw; Ø 3.5 x 45; fully threaded; titanium	4 047075 094974
3.230.46	cancellous screw; Ø 3.5 x 46; fully threaded; titanium	4 047075 094868
3.230.48	cancellous screw; Ø 3.5 x 48; fully threaded; titanium	4 047075 094875
3.230.50	cancellous screw; Ø 3.5 x 50; fully threaded; titanium	4 047075 094882
3.230.55	cancellous screw; Ø 3.5 x 55; fully threaded; titanium	4 047075 094899
3.230.60	cancellous screw; Ø 3.5 x 60; fully threaded; titanium	4 047075 094905
3.230.65	cancellous screw; Ø 3.5 x 65; fully threaded; titanium	4 047075 094912

Cancellous screws

Standard; titanium

Item no.	Item description	EAN
3.230.70	cancellous screw; Ø 3.5 x 70; fully threaded; titanium	
3.230.80	cancellous screw; Ø 3.5 x 80; fully threaded; titanium	
Cancellous screw 3.5 st		
3.232.10	cancellous screw; Ø 3.5 x 10; fully threaded; self tapping; titanium	
3.232.12	cancellous screw; Ø 3.5 x 12; fully threaded; self tapping; titanium	
3.232.14	cancellous screw; Ø 3.5 x 14; fully threaded; self tapping; titanium	
3.232.16	cancellous screw; Ø 3.5 x 16; fully threaded; self tapping; titanium	
3.232.18	cancellous screw; Ø 3.5 x 18; fully threaded; self tapping; titanium	
3.232.20	cancellous screw; Ø 3.5 x 20; fully threaded; self tapping; titanium	
3.232.22	cancellous screw; Ø 3.5 x 22; fully threaded; self tapping; titanium	
3.232.24	cancellous screw; Ø 3.5 x 24; fully threaded; self tapping; titanium	
3.232.26	cancellous screw; Ø 3.5 x 26; fully threaded; self tapping; titanium	
3.232.28	cancellous screw; Ø 3.5 x 28; fully threaded; self tapping; titanium	
3.232.30	cancellous screw; Ø 3.5 x 30; fully threaded; self tapping; titanium	
3.232.32	cancellous screw; Ø 3.5 x 32; fully threaded; self tapping; titanium	
3.232.34	cancellous screw; Ø 3.5 x 34; fully threaded; self tapping; titanium	
3.232.35	cancellous screw; Ø 3.5 x 35; fully threaded; self tapping; titanium	
3.232.36	cancellous screw; Ø 3.5 x 36; fully threaded; self tapping; titanium	
3.232.38	cancellous screw; Ø 3.5 x 38; fully threaded; self tapping; titanium	
3.232.40	cancellous screw; Ø 3.5 x 40; fully threaded; self tapping; titanium	
3.232.45	cancellous screw; Ø 3.5 x 45; fully threaded; self tapping; titanium	
3.232.50	cancellous screw; Ø 3.5 x 50; fully threaded; self tapping; titanium	
3.232.55	cancellous screw; Ø 3.5 x 55; fully threaded; self tapping; titanium	
3.232.60	cancellous screw; Ø 3.5 x 60; fully threaded; self tapping; titanium	
Cancellous screw 4.0 partial thread bt		
3.140.10	cancellous screw; Ø 4 x 10; thread 5; back tapping; titanium	
3.140.12	cancellous screw; Ø 4 x 12; thread 5; back tapping; titanium	
3.140.14	cancellous screw; Ø 4 x 14; thread 5; back tapping; titanium	
3.140.16	cancellous screw; Ø 4 x 16; thread 6; back tapping; titanium	
3.140.18	cancellous screw; Ø 4 x 18; thread 7; back tapping; titanium	
3.140.20	cancellous screw; Ø 4 x 20; thread 8; back tapping; titanium	
3.140.22	cancellous screw; Ø 4 x 22; thread 9; back tapping; titanium	
3.140.24	cancellous screw; Ø 4 x 24; thread 10; back tapping; titanium	
3.140.26	cancellous screw; Ø 4 x 26; thread 12; back tapping; titanium	
3.140.28	cancellous screw; Ø 4 x 28; thread 14; back tapping; titanium	

Cancellous screws

Standard; titanium

Item no.	Item description	EAN
3.140.30	cancellous screw; Ø 4 x 30; thread 14; back tapping; titanium	4 047075 090402
3.140.32	cancellous screw; Ø 4 x 32; thread 14; back tapping; titanium	4 047075 090297
3.140.34	cancellous screw; Ø 4 x 34; thread 14; back tapping; titanium	4 047075 090303
3.140.35	cancellous screw; Ø 4 x 35; thread 14; back tapping; titanium	4 047075 090501
3.140.36	cancellous screw; Ø 4 x 36; thread 14; back tapping; titanium	4 047075 090389
3.140.38	cancellous screw; Ø 4 x 38; thread 14; back tapping; titanium	4 047075 090396
3.140.40	cancellous screw; Ø 4 x 40; thread 14; back tapping; titanium	4 047075 090419
3.140.42	cancellous screw; Ø 4 x 42; thread 15; back tapping; titanium	4 047075 090426
3.140.44	cancellous screw; Ø 4 x 44; thread 15; back tapping; titanium	4 047075 090433
3.140.45	cancellous screw; Ø 4 x 45; thread 15; back tapping; titanium	4 047075 090440
3.140.46	cancellous screw; Ø 4 x 46; thread 15; back tapping; titanium	4 047075 090334
3.140.48	cancellous screw; Ø 4 x 48; thread 15; back tapping; titanium	4 047075 090600
3.140.50	cancellous screw; Ø 4 x 50; thread 15; back tapping; titanium	4 047075 090525
3.140.52	cancellous screw; Ø 4 x 52; thread 16; back tapping; titanium	4 047075 090532
3.140.54	cancellous screw; Ø 4 x 54; thread 16; back tapping; titanium	4 047075 090549
3.140.55	cancellous screw; Ø 4 x 55; thread 16; back tapping; titanium	4 047075 090457
3.140.56	cancellous screw; Ø 4 x 56; thread 16; back tapping; titanium	4 047075 090464
3.140.58	cancellous screw; Ø 4 x 58; thread 16; back tapping; titanium	4 047075 090488
3.140.60	cancellous screw; Ø 4 x 60; thread 16; back tapping; titanium	4 047075 090495
3.140.64	cancellous screw; Ø 4 x 64; thread 17; back tapping; titanium	4 047075 090624
3.140.65	cancellous screw; Ø 4 x 65; thread 17; back tapping; titanium	4 047075 090631
3.140.70	cancellous screw; Ø 4 x 70; thread 17; back tapping; titanium	4 047075 090556
3.140.75	cancellous screw; Ø 4 x 75; thread 17; back tapping; titanium	4 047075 090662
3.140.80	cancellous screw; Ø 4 x 80; thread 17; back tapping; titanium	4 047075 090563
3.140.85	cancellous screw; Ø 4 x 85; thread 18; back tapping; titanium	4 047075 090570
3.140.90	cancellous screw; Ø 4 x 90; thread 18; back tapping; titanium	4 047075 090587
3.140.95	cancellous screw; Ø 4 x 95; thread 18; back tapping; titanium	4 047075 090518
3.140.100	cancellous screw; Ø 4 x 100; thread 18; back tapping; titanium	4 047075 090341
3.140.105	cancellous screw; Ø 4 x 105; thread 18; back tapping; titanium	4 047075 061112
3.140.110	cancellous screw; Ø 4 x 110; thread 18; back tapping; titanium	4 047075 037919
Cancellous screw 4.0		
3.145.10	cancellous screw; Ø 4 x 10; fully threaded; titanium	4 047075 090952
3.145.12	cancellous screw; Ø 4 x 12; fully threaded; titanium	4 047075 090877
3.145.14	cancellous screw; Ø 4 x 14; fully threaded; titanium	4 047075 090990
3.145.15	cancellous screw; Ø 4 x 15; fully threaded; titanium	4 047075 090891

































Cancellous screws

Standard; titanium

Item no.	Item description	EAN
3.145.16	cancellous screw; Ø 4 x 16; fully threaded; titanium	4 047075 090907
3.145.18	cancellous screw; Ø 4 x 18; fully threaded; titanium	4 047075 090914
3.145.20	cancellous screw; Ø 4 x 20; fully threaded; titanium	4 047075 090808
3.145.22	cancellous screw; Ø 4 x 22; fully threaded; titanium	4 047075 090983
3.145.24	cancellous screw; Ø 4 x 24; fully threaded; titanium	4 047075 091003
3.145.25	cancellous screw; Ø 4 x 25; fully threaded; titanium	4 047075 091010
3.145.26	cancellous screw; Ø 4 x 26; fully threaded; titanium	4 047075 091027
3.145.28	cancellous screw; Ø 4 x 28; fully threaded; titanium	4 047075 091034
3.145.30	cancellous screw; Ø 4 x 30; fully threaded; titanium	4 047075 090921
3.145.32	cancellous screw; Ø 4 x 32; fully threaded; titanium	4 047075 091058
3.145.34	cancellous screw; Ø 4 x 34; fully threaded; titanium	4 047075 090938
3.145.35	cancellous screw; Ø 4 x 35; fully threaded; titanium	4 047075 091126
3.145.36	cancellous screw; Ø 4 x 36; fully threaded; titanium	4 047075 091133
3.145.38	cancellous screw; Ø 4 x 38; fully threaded; titanium	4 047075 091041
3.145.40	cancellous screw; Ø 4 x 40; fully threaded; titanium	4 047075 091164
3.145.42	cancellous screw; Ø 4 x 42; fully threaded; titanium	4 047075 091065
3.145.44	cancellous screw; Ø 4 x 44; fully threaded; titanium	4 047075 091072
3.145.45	cancellous screw; Ø 4 x 45; fully threaded; titanium	4 047075 091089
3.145.46	cancellous screw; Ø 4 x 46; fully threaded; titanium	4 047075 090976
3.145.48	cancellous screw; Ø 4 x 48; fully threaded; titanium	4 047075 091157
3.145.50	cancellous screw; Ø 4 x 50; fully threaded; titanium	4 047075 091171
3.145.52	cancellous screw; Ø 4 x 52; fully threaded; titanium	4 047075 091188
3.145.54	cancellous screw; Ø 4 x 54; fully threaded; titanium	4 047075 091195
3.145.55	cancellous screw; Ø 4 x 55; fully threaded; titanium	4 047075 091201
3.145.56	cancellous screw; Ø 4 x 56; fully threaded; titanium	4 047075 091096
3.145.58	cancellous screw; Ø 4 x 58; fully threaded; titanium	4 047075 002238
3.145.60	cancellous screw; Ø 4 x 60; fully threaded; titanium	4 047075 091102
3.145.65	cancellous screw; Ø 4 x 65; fully threaded; titanium	4 047075 091232
3.145.70	cancellous screw; Ø 4 x 70; fully threaded; titanium	4 047075 091119
3.145.75	cancellous screw; Ø 4 x 75; fully threaded; titanium	4 047075 091324
3.145.80	cancellous screw; Ø 4 x 80; fully threaded; titanium	4 047075 091331
3.145.85	cancellous screw; Ø 4 x 85; fully threaded; titanium	4 047075 037971
3.145.90	cancellous screw; Ø 4 x 90; fully threaded; titanium	4 047075 037988
3.145.95	cancellous screw; Ø 4 x 95; fully threaded; titanium	4 047075 037995
3.145.100	cancellous screw; Ø 4 x 100; fully threaded; titanium	4 047075 038008

Cancellous screws

Standard; titanium

Item no.	Item description	EAN
3.145.105	cancellous screw; Ø 4 x 105; fully threaded; titanium	 4 047075 038015
3.145.110	cancellous screw; Ø 4 x 110; fully threaded; titanium	 4 047075 038022
Cancellous screw 6.0 thread 32		
3.183.45	cancellous screw; Ø 6 x 45; thread 32; titanium	 4 047075 153053
3.183.50	cancellous screw; Ø 6 x 50; thread 32; titanium	 4 047075 153060
3.183.55	cancellous screw; Ø 6 x 55; thread 32; titanium	 4 047075 153077
3.183.60	cancellous screw; Ø 6 x 60; thread 32; titanium	 4 047075 153084
3.183.65	cancellous screw; Ø 6 x 65; thread 32; titanium	 4 047075 153091
3.183.70	cancellous screw; Ø 6 x 70; thread 32; titanium	 4 047075 153107
3.183.75	cancellous screw; Ø 6 x 75; thread 32; titanium	 4 047075 153114
3.183.80	cancellous screw; Ø 6 x 80; thread 32; titanium	 4 047075 153121
3.183.85	cancellous screw; Ø 6 x 85; thread 32; titanium	 4 047075 153138
3.183.90	cancellous screw; Ø 6 x 90; thread 32; titanium	 4 047075 153145
3.183.95	cancellous screw; Ø 6 x 95; thread 32; titanium	 4 047075 153152
Cancellous screw 6.5 thread 16		
3.170.25	cancellous screw; Ø 6.5 x 25; thread 16; titanium	 4 047075 093700
3.170.30	cancellous screw; Ø 6.5 x 30; thread 16; titanium	 4 047075 093717
3.170.35	cancellous screw; Ø 6.5 x 35; thread 16; titanium	 4 047075 093618
3.170.40	cancellous screw; Ø 6.5 x 40; thread 16; titanium	 4 047075 093786
3.170.45	cancellous screw; Ø 6.5 x 45; thread 16; titanium	 4 047075 093809
3.170.50	cancellous screw; Ø 6.5 x 50; thread 16; titanium	 4 047075 093816
3.170.55	cancellous screw; Ø 6.5 x 55; thread 16; titanium	 4 047075 093823
3.170.60	cancellous screw; Ø 6.5 x 60; thread 16; titanium	 4 047075 093830
3.170.65	cancellous screw; Ø 6.5 x 65; thread 16; titanium	 4 047075 093724
3.170.70	cancellous screw; Ø 6.5 x 70; thread 16; titanium	 4 047075 093854
3.170.75	cancellous screw; Ø 6.5 x 75; thread 16; titanium	 4 047075 093748
3.170.80	cancellous screw; Ø 6.5 x 80; thread 16; titanium	 4 047075 093946
3.170.85	cancellous screw; Ø 6.5 x 85; thread 16; titanium	 4 047075 093953
3.170.90	cancellous screw; Ø 6.5 x 90; thread 16; titanium	 4 047075 093847
3.170.95	cancellous screw; Ø 6.5 x 95; thread 16; titanium	 4 047075 093977
3.170.100	cancellous screw; Ø 6.5 x 100; thread 16; titanium	 4 047075 093755
3.170.105	cancellous screw; Ø 6.5 x 105; thread 16; titanium	 4 047075 093762
3.170.110	cancellous screw; Ø 6.5 x 110; thread 16; titanium	 4 047075 093670
3.170.115	cancellous screw; Ø 6.5 x 115; thread 16; titanium	 4 047075 093793
3.170.120	cancellous screw; Ø 6.5 x 120; thread 16; titanium	 4 047075 093694













Cancellous screws

Standard; titanium

Item no.	Item description	EAN
Cancellous screw 6.5 thread 32		
3.180.45	cancellous screw; Ø 6.5 x 45; thread 32; titanium	4 047075 094097
3.180.50	cancellous screw; Ø 6.5 x 50; thread 32; titanium	4 047075 094103
3.180.55	cancellous screw; Ø 6.5 x 55; thread 32; titanium	4 047075 094011
3.180.60	cancellous screw; Ø 6.5 x 60; thread 32; titanium	4 047075 094127
3.180.65	cancellous screw; Ø 6.5 x 65; thread 32; titanium	4 047075 094028
3.180.70	cancellous screw; Ø 6.5 x 70; thread 32; titanium	4 047075 094035
3.180.75	cancellous screw; Ø 6.5 x 75; thread 32; titanium	4 047075 094042
3.180.80	cancellous screw; Ø 6.5 x 80; thread 32; titanium	4 047075 093960
3.180.85	cancellous screw; Ø 6.5 x 85; thread 32; titanium	4 047075 094240
3.180.90	cancellous screw; Ø 6.5 x 90; thread 32; titanium	4 047075 094134
3.180.95	cancellous screw; Ø 6.5 x 95; thread 32; titanium	4 047075 094141
3.180.100	cancellous screw; Ø 6.5 x 100; thread 32; titanium	4 047075 093878
3.180.105	cancellous screw; Ø 6.5 x 105; thread 32; titanium	4 047075 093885
3.180.110	cancellous screw; Ø 6.5 x 110; thread 32; titanium	4 047075 093892
3.180.115	cancellous screw; Ø 6.5 x 115; thread 32; titanium	4 047075 093779
3.180.120	cancellous screw; Ø 6.5 x 120; thread 32; titanium	4 047075 094066
3.180.125	cancellous screw; Ø 6.5 x 125; thread 32; titanium	4 047075 093984
3.180.130	cancellous screw; Ø 6.5 x 130; thread 32; titanium	4 047075 093991
3.180.135	cancellous screw; Ø 6.5 x 135; thread 32; titanium	4 047075 094004
3.180.140	cancellous screw; Ø 6.5 x 140; thread 32; titanium	4 047075 093908
3.180.145	cancellous screw; Ø 6.5 x 145; thread 32; titanium	4 047075 093915
3.180.150	cancellous screw; Ø 6.5 x 150; thread 32; titanium	4 047075 093922
Cancellous screw 6.5		
3.190.15	cancellous screw; Ø 6.5 x 15; fully threaded; titanium	4 047075 094080
3.190.20	cancellous screw; Ø 6.5 x 20; fully threaded; titanium	4 047075 094271
3.190.25	cancellous screw; Ø 6.5 x 25; fully threaded; titanium	4 047075 094288
3.190.30	cancellous screw; Ø 6.5 x 30; fully threaded; titanium	4 047075 094172
3.190.35	cancellous screw; Ø 6.5 x 35; fully threaded; titanium	4 047075 094301
3.190.40	cancellous screw; Ø 6.5 x 40; fully threaded; titanium	4 047075 094196
3.190.45	cancellous screw; Ø 6.5 x 45; fully threaded; titanium	4 047075 094202
3.190.50	cancellous screw; Ø 6.5 x 50; fully threaded; titanium	4 047075 094219
3.190.55	cancellous screw; Ø 6.5 x 55; fully threaded; titanium	4 047075 094110
3.190.60	cancellous screw; Ø 6.5 x 60; fully threaded; titanium	4 047075 094394
3.190.65	cancellous screw; Ø 6.5 x 65; fully threaded; titanium	4 047075 094318

Cancellous screws

Standard; titanium

Item no.	Item description	EAN
3.190.70	cancellous screw; Ø 6.5 x 70; fully threaded; titanium	 4 047075 094325
3.190.75	cancellous screw; Ø 6.5 x 75; fully threaded; titanium	 4 047075 094332
3.190.80	cancellous screw; Ø 6.5 x 80; fully threaded; titanium	 4 047075 094226
3.190.85	cancellous screw; Ø 6.5 x 85; fully threaded; titanium	 4 047075 094233
3.190.90	cancellous screw; Ø 6.5 x 90; fully threaded; titanium	 4 047075 094257
3.190.95	cancellous screw; Ø 6.5 x 95; fully threaded; titanium	 4 047075 094264
3.190.100	cancellous screw; Ø 6.5 x 100; fully threaded; titanium	 4 047075 094165
3.190.105	cancellous screw; Ø 6.5 x 105; fully threaded; titanium	 4 047075 094059
3.190.110	cancellous screw; Ø 6.5 x 110; fully threaded; titanium	 4 047075 094189
3.190.115	cancellous screw; Ø 6.5 x 115; fully threaded; titanium	 4 047075 094073
3.190.120	cancellous screw; Ø 6.5 x 120; fully threaded; titanium	 4 047075 119660
3.190.125	cancellous screw; Ø 6.5 x 125; fully threaded; titanium	 4 047075 119677
3.190.130	cancellous screw; Ø 6.5 x 130; fully threaded; titanium	 4 047075 119684

Cancellous screws

Standard; stainless steel



Item no. 2.230.18



Item no. 2.232.20



Item no. 2.140.30



Item no. 2.145.30



Item no. 2.170.50



Item no. 2.180.50



Item no. 2.190.50

Item no.	Item description	EAN
----------	------------------	-----

Cancellous screw 3.5

2.230.10	cancellous screw; Ø 3.5 x 10; fully threaded; stainless steel	4 047075 062201
2.230.12	cancellous screw; Ø 3.5 x 12; fully threaded; stainless steel	4 047075 062324
2.230.14	cancellous screw; Ø 3.5 x 14; fully threaded; stainless steel	4 047075 062218
2.230.16	cancellous screw; Ø 3.5 x 16; fully threaded; stainless steel	4 047075 062225
2.230.18	cancellous screw; Ø 3.5 x 18; fully threaded; stainless steel	4 047075 062232
2.230.20	cancellous screw; Ø 3.5 x 20; fully threaded; stainless steel	4 047075 062102
2.230.22	cancellous screw; Ø 3.5 x 22; fully threaded; stainless steel	4 047075 062263
2.230.24	cancellous screw; Ø 3.5 x 24; fully threaded; stainless steel	4 047075 062157
2.230.26	cancellous screw; Ø 3.5 x 26; fully threaded; stainless steel	4 047075 062164
2.230.28	cancellous screw; Ø 3.5 x 28; fully threaded; stainless steel	4 047075 062171
2.230.30	cancellous screw; Ø 3.5 x 30; fully threaded; stainless steel	4 047075 062041
2.230.32	cancellous screw; Ø 3.5 x 32; fully threaded; stainless steel	4 047075 076215
2.230.34	cancellous screw; Ø 3.5 x 34; fully threaded; stainless steel	4 047075 076222
2.230.35	cancellous screw; Ø 3.5 x 35; fully threaded; stainless steel	4 047075 076130
2.230.36	cancellous screw; Ø 3.5 x 36; fully threaded; stainless steel	4 047075 076147
2.230.38	cancellous screw; Ø 3.5 x 38; fully threaded; stainless steel	4 047075 076048
2.230.40	cancellous screw; Ø 3.5 x 40; fully threaded; stainless steel	4 047075 076055
2.230.42	cancellous screw; Ø 3.5 x 42; fully threaded; stainless steel	4 047075 076178
2.230.44	cancellous screw; Ø 3.5 x 44; fully threaded; stainless steel	4 047075 076079
2.230.45	cancellous screw; Ø 3.5 x 45; fully threaded; stainless steel	4 047075 076246
2.230.46	cancellous screw; Ø 3.5 x 46; fully threaded; stainless steel	4 047075 076253
2.230.48	cancellous screw; Ø 3.5 x 48; fully threaded; stainless steel	4 047075 076154
2.230.50	cancellous screw; Ø 3.5 x 50; fully threaded; stainless steel	4 047075 076161
2.230.55	cancellous screw; Ø 3.5 x 55; fully threaded; stainless steel	4 047075 076284
2.230.60	cancellous screw; Ø 3.5 x 60; fully threaded; stainless steel	4 047075 076291
2.230.65	cancellous screw; Ø 3.5 x 65; fully threaded; stainless steel	4 047075 076185























Cortical screws

Standard; stainless steel

Item no.	Item description	EAN
2.110.24	cortical screw; Ø 2 x 24; fully threaded; self tapping; stainless steel	 4 047075 067572
2.110.26	cortical screw; Ø 2 x 26; fully threaded; self tapping; stainless steel	 4 047075 067473
2.110.28	cortical screw; Ø 2 x 28; fully threaded; self tapping; stainless steel	 4 047075 067763
2.110.30	cortical screw; Ø 2 x 30; fully threaded; self tapping; stainless steel	 4 047075 067770
2.110.32	cortical screw; Ø 2 x 32; fully threaded; self tapping; stainless steel	 4 047075 067671
2.110.34	cortical screw; Ø 2 x 34; fully threaded; self tapping; stainless steel	 4 047075 067688
2.110.36	cortical screw; Ø 2 x 36; fully threaded; self tapping; stainless steel	 4 047075 067589
2.110.38	cortical screw; Ø 2 x 38; fully threaded; self tapping; stainless steel	 4 047075 067596
2.110.40	cortical screw; Ø 2 x 40; fully threaded; self tapping; stainless steel	 4 047075 067701
Cortical screw 2.7 st		
2.120.06	cortical screw; Ø 2.7 x 6; fully threaded; self tapping; stainless steel	 4 047075 067756
2.120.08	cortical screw; Ø 2.7 x 8; fully threaded; self tapping; stainless steel	 4 047075 067886
2.120.10	cortical screw; Ø 2.7 x 10; fully threaded; self tapping; stainless steel	 4 047075 067893
2.120.12	cortical screw; Ø 2.7 x 12; fully threaded; self tapping; stainless steel	 4 047075 067787
2.120.14	cortical screw; Ø 2.7 x 14; fully threaded; self tapping; stainless steel	 4 047075 068005
2.120.16	cortical screw; Ø 2.7 x 16; fully threaded; self tapping; stainless steel	 4 047075 067862
2.120.18	cortical screw; Ø 2.7 x 18; fully threaded; self tapping; stainless steel	 4 047075 067879
2.120.20	cortical screw; Ø 2.7 x 20; fully threaded; self tapping; stainless steel	 4 047075 068029
2.120.22	cortical screw; Ø 2.7 x 22; fully threaded; self tapping; stainless steel	 4 047075 067909
2.120.24	cortical screw; Ø 2.7 x 24; fully threaded; self tapping; stainless steel	 4 047075 067916
2.120.26	cortical screw; Ø 2.7 x 26; fully threaded; self tapping; stainless steel	 4 047075 067923
2.120.28	cortical screw; Ø 2.7 x 28; fully threaded; self tapping; stainless steel	 4 047075 067817
2.120.30	cortical screw; Ø 2.7 x 30; fully threaded; self tapping; stainless steel	 4 047075 068142
2.120.32	cortical screw; Ø 2.7 x 32; fully threaded; self tapping; stainless steel	 4 047075 068036
2.120.34	cortical screw; Ø 2.7 x 34; fully threaded; self tapping; stainless steel	 4 047075 068043
2.120.36	cortical screw; Ø 2.7 x 36; fully threaded; self tapping; stainless steel	 4 047075 068050
2.120.38	cortical screw; Ø 2.7 x 38; fully threaded; self tapping; stainless steel	 4 047075 067930
2.120.40	cortical screw; Ø 2.7 x 40; fully threaded; self tapping; stainless steel	 4 047075 068081
2.120.42	cortical screw; Ø 2.7 x 42; fully threaded; self tapping; stainless steel	 4 047075 068098
2.120.44	cortical screw; Ø 2.7 x 44; fully threaded; self tapping; stainless steel	 4 047075 067978
2.120.46	cortical screw; Ø 2.7 x 46; fully threaded; self tapping; stainless steel	 4 047075 067985
2.120.48	cortical screw; Ø 2.7 x 48; fully threaded; self tapping; stainless steel	 4 047075 067992
2.120.50	cortical screw; Ø 2.7 x 50; fully threaded; self tapping; stainless steel	 4 047075 068166
Cortical screw 3.5 - on sale, only a few available. Please use the self-tapping alternative article		
2.130.06	cortical screw; Ø 3.5 x 6; fully threaded; stainless steel	 4 047075 068388

Cancellous screws

Standard; stainless steel

Item no.	Item description	EAN
2.140.55	cancellous screw; Ø 4 x 55; thread 16; back tapping; stainless steel	 4 047075 069606
2.140.56	cancellous screw; Ø 4 x 56; thread 16; back tapping; stainless steel	 4 047075 069798
2.140.58	cancellous screw; Ø 4 x 58; thread 16; back tapping; stainless steel	 4 047075 069804
2.140.60	cancellous screw; Ø 4 x 60; thread 16; back tapping; stainless steel	 4 047075 069705
2.140.62	cancellous screw; Ø 4 x 62; thread 17; back tapping; stainless steel	 4 047075 069712
2.140.64	cancellous screw; Ø 4 x 64; thread 17; back tapping; stainless steel	 4 047075 069828
2.140.65	cancellous screw; Ø 4 x 65; thread 17; back tapping; stainless steel	 4 047075 069736
2.140.70	cancellous screw; Ø 4 x 70; thread 17; back tapping; stainless steel	 4 047075 069743
2.140.75	cancellous screw; Ø 4 x 75; thread 17; back tapping; stainless steel	 4 047075 069750
2.140.80	cancellous screw; Ø 4 x 80; thread 17; back tapping; stainless steel	 4 047075 069637
2.140.85	cancellous screw; Ø 4 x 85; thread 18; back tapping; stainless steel	 4 047075 069941
2.140.90	cancellous screw; Ø 4 x 90; thread 18; back tapping; stainless steel	 4 047075 069835
2.140.95	cancellous screw; Ø 4 x 95; thread 18; back tapping; stainless steel	 4 047075 069842
2.140.100	cancellous screw; Ø 4 x 100; thread 18; back tapping; stainless steel	 4 047075 069415
Cancellous screw 4.0		
2.145.10	cancellous screw; Ø 4 x 10; fully threaded; stainless steel	 4 047075 070268
2.145.12	cancellous screw; Ø 4 x 12; fully threaded; stainless steel	 4 047075 070176
2.145.14	cancellous screw; Ø 4 x 14; fully threaded; stainless steel	 4 047075 070183
2.145.16	cancellous screw; Ø 4 x 16; fully threaded; stainless steel	 4 047075 070091
2.145.18	cancellous screw; Ø 4 x 18; fully threaded; stainless steel	 4 047075 070107
2.145.20	cancellous screw; Ø 4 x 20; fully threaded; stainless steel	 4 047075 070206
2.145.22	cancellous screw; Ø 4 x 22; fully threaded; stainless steel	 4 047075 070121
2.145.24	cancellous screw; Ø 4 x 24; fully threaded; stainless steel	 4 047075 070299
2.145.26	cancellous screw; Ø 4 x 26; fully threaded; stainless steel	 4 047075 070305
2.145.28	cancellous screw; Ø 4 x 28; fully threaded; stainless steel	 4 047075 070190
2.145.30	cancellous screw; Ø 4 x 30; fully threaded; stainless steel	 4 047075 070329
2.145.32	cancellous screw; Ø 4 x 32; fully threaded; stainless steel	 4 047075 070213
2.145.34	cancellous screw; Ø 4 x 34; fully threaded; stainless steel	 4 047075 070220
2.145.35	cancellous screw; Ø 4 x 35; fully threaded; stainless steel	 4 047075 070237
2.145.36	cancellous screw; Ø 4 x 36; fully threaded; stainless steel	 4 047075 070145
2.145.38	cancellous screw; Ø 4 x 38; fully threaded; stainless steel	 4 047075 070428
2.145.40	cancellous screw; Ø 4 x 40; fully threaded; stainless steel	 4 047075 070435
2.145.42	cancellous screw; Ø 4 x 42; fully threaded; stainless steel	 4 047075 070336
2.145.44	cancellous screw; Ø 4 x 44; fully threaded; stainless steel	 4 047075 070343
2.145.45	cancellous screw; Ø 4 x 45; fully threaded; stainless steel	 4 047075 070244

Cortical screws

Standard; stainless steel

Item no.	Item description	EAN
2.130.110	cortical screw; Ø 3.5 x 110; fully threaded; stainless steel	4 047075 068302
2.130.115	cortical screw; Ø 3.5 x 115; fully threaded; stainless steel	4 047075 068180
2.130.120	cortical screw; Ø 3.5 x 120; fully threaded; stainless steel	4 047075 068364
2.130.125	cortical screw; Ø 3.5 x 125; fully threaded; stainless steel	4 047075 068548
2.130.130	cortical screw; Ø 3.5 x 130; fully threaded; stainless steel	4 047075 068401
2.130.135	cortical screw; Ø 3.5 x 135; fully threaded; stainless steel	4 047075 068418
2.130.140	cortical screw; Ø 3.5 x 140; fully threaded; stainless steel	4 047075 068432
Cortical screw 3.5 st		
2.132.08	cortical screw; Ø 3.5 x 8; fully threaded; self tapping; stainless steel	4 047075 068869
2.132.10	cortical screw; Ø 3.5 x 10; fully threaded; self tapping; stainless steel	4 047075 068876
2.132.12	cortical screw; Ø 3.5 x 12; fully threaded; self tapping; stainless steel	4 047075 068920
2.132.14	cortical screw; Ø 3.5 x 14; fully threaded; self tapping; stainless steel	4 047075 068753
2.132.16	cortical screw; Ø 3.5 x 16; fully threaded; self tapping; stainless steel	4 047075 068777
2.132.18	cortical screw; Ø 3.5 x 18; fully threaded; self tapping; stainless steel	4 047075 068593
2.132.20	cortical screw; Ø 3.5 x 20; fully threaded; self tapping; stainless steel	4 047075 068609
2.132.22	cortical screw; Ø 3.5 x 22; fully threaded; self tapping; stainless steel	4 047075 069095
2.132.24	cortical screw; Ø 3.5 x 24; fully threaded; self tapping; stainless steel	4 047075 069101
2.132.26	cortical screw; Ø 3.5 x 26; fully threaded; self tapping; stainless steel	4 047075 068944
2.132.28	cortical screw; Ø 3.5 x 28; fully threaded; self tapping; stainless steel	4 047075 068951
2.132.30	cortical screw; Ø 3.5 x 30; fully threaded; self tapping; stainless steel	4 047075 068968
2.132.32	cortical screw; Ø 3.5 x 32; fully threaded; self tapping; stainless steel	4 047075 068975
2.132.34	cortical screw; Ø 3.5 x 34; fully threaded; self tapping; stainless steel	4 047075 068784
2.132.36	cortical screw; Ø 3.5 x 36; fully threaded; self tapping; stainless steel	4 047075 068791
2.132.38	cortical screw; Ø 3.5 x 38; fully threaded; self tapping; stainless steel	4 047075 069002
2.132.40	cortical screw; Ø 3.5 x 40; fully threaded; self tapping; stainless steel	4 047075 069019
2.132.42	cortical screw; Ø 3.5 x 42; fully threaded; self tapping; stainless steel	4 047075 068821
2.132.44	cortical screw; Ø 3.5 x 44; fully threaded; self tapping; stainless steel	4 047075 068838
2.132.45	cortical screw; Ø 3.5 x 45; fully threaded; self tapping; stainless steel	4 047075 069125
2.132.46	cortical screw; Ø 3.5 x 46; fully threaded; self tapping; stainless steel	4 047075 069132
2.132.48	cortical screw; Ø 3.5 x 48; fully threaded; self tapping; stainless steel	4 047075 069149
2.132.50	cortical screw; Ø 3.5 x 50; fully threaded; self tapping; stainless steel	4 047075 068982
2.132.55	cortical screw; Ø 3.5 x 55; fully threaded; self tapping; stainless steel	4 047075 068999
2.132.60	cortical screw; Ø 3.5 x 60; fully threaded; self tapping; stainless steel	4 047075 069163
2.132.65	cortical screw; Ø 3.5 x 65; fully threaded; self tapping; stainless steel	4 047075 069170
2.132.68	cortical screw; Ø 3.5 x 68; fully threaded; self tapping; stainless steel	4 047075 069026





























Cortical screws

Standard; stainless steel

Item no.	Item description	EAN
2.132.70	cortical screw; Ø 3.5 x 70; fully threaded; self tapping; stainless steel	4 047075 069033
2.132.75	cortical screw; Ø 3.5 x 75; fully threaded; self tapping; stainless steel	4 047075 069040
2.132.80	cortical screw; Ø 3.5 x 80; fully threaded; self tapping; stainless steel	4 047075 069057
2.132.85	cortical screw; Ø 3.5 x 85; fully threaded; self tapping; stainless steel	4 047075 069064
2.132.90	cortical screw; Ø 3.5 x 90; fully threaded; self tapping; stainless steel	4 047075 068883
2.132.95	cortical screw; Ø 3.5 x 95; fully threaded; self tapping; stainless steel	4 047075 068890
2.132.100	cortical screw; Ø 3.5 x 100; fully threaded; self tapping; stainless steel	4 047075 068685
2.132.105	cortical screw; Ø 3.5 x 105; fully threaded; self tapping; stainless steel	4 047075 068692
2.132.110	cortical screw; Ø 3.5 x 110; fully threaded; self tapping; stainless steel	4 047075 068906
2.132.115	cortical screw; Ø 3.5 x 115; fully threaded; self tapping; stainless steel	4 047075 068913
2.132.120	cortical screw; Ø 3.5 x 120; fully threaded; self tapping; stainless steel	4 047075 068937
2.132.125	cortical screw; Ø 3.5 x 125; fully threaded; self tapping; stainless steel	4 047075 068739
2.132.135	cortical screw; Ø 3.5 x 135; fully threaded; self tapping; stainless steel	4 047075 068746
2.132.140	cortical screw; Ø 3.5 x 140; fully threaded; self tapping; stainless steel	4 047075 068760
Cortical screw 4.5 - on sale, only a few available. Please use the self-tapping alternative article		
2.150.12	cortical screw; Ø 4.5 x 12; fully threaded; stainless steel	4 047075 070664
2.150.14	cortical screw; Ø 4.5 x 14; fully threaded; stainless steel	4 047075 070756
2.150.16	cortical screw; Ø 4.5 x 16; fully threaded; stainless steel	4 047075 070671
2.150.18	cortical screw; Ø 4.5 x 18; fully threaded; stainless steel	4 047075 070688
2.150.20	cortical screw; Ø 4.5 x 20; fully threaded; stainless steel	4 047075 070565
2.150.22	cortical screw; Ø 4.5 x 22; fully threaded; stainless steel	4 047075 070701
2.150.24	cortical screw; Ø 4.5 x 24; fully threaded; stainless steel	4 047075 070596
2.150.25	cortical screw; Ø 4.5 x 25; fully threaded; stainless steel	4 047075 070787
2.150.26	cortical screw; Ø 4.5 x 26; fully threaded; stainless steel	4 047075 070794
2.150.28	cortical screw; Ø 4.5 x 28; fully threaded; stainless steel	4 047075 070695
2.150.30	cortical screw; Ø 4.5 x 30; fully threaded; stainless steel	4 047075 070817
2.150.32	cortical screw; Ø 4.5 x 32; fully threaded; stainless steel	4 047075 070718
2.150.34	cortical screw; Ø 4.5 x 34; fully threaded; stainless steel	4 047075 070725
2.150.35	cortical screw; Ø 4.5 x 35; fully threaded; stainless steel	4 047075 070732
2.150.36	cortical screw; Ø 4.5 x 36; fully threaded; stainless steel	4 047075 070633
2.150.38	cortical screw; Ø 4.5 x 38; fully threaded; stainless steel	4 047075 070916
2.150.40	cortical screw; Ø 4.5 x 40; fully threaded; stainless steel	4 047075 070824
2.150.42	cortical screw; Ø 4.5 x 42; fully threaded; stainless steel	4 047075 070831
2.150.44	cortical screw; Ø 4.5 x 44; fully threaded; stainless steel	4 047075 070848
2.150.45	cortical screw; Ø 4.5 x 45; fully threaded; stainless steel	4 047075 070749

Cancellous screws

Standard; stainless steel

Item no.	Item description	EAN
2.180.150	cancellous screw; Ø 6.5 x 150; thread 32; stainless steel	 4 047075 063178
Cancellous screw 6.5		
2.190.16	cancellous screw; Ø 6.5 x 16; fully threaded; stainless steel	 4 047075 062836
2.190.20	cancellous screw; Ø 6.5 x 20; fully threaded; stainless steel	 4 047075 062843
2.190.25	cancellous screw; Ø 6.5 x 25; fully threaded; stainless steel	 4 047075 062850
2.190.30	cancellous screw; Ø 6.5 x 30; fully threaded; stainless steel	 4 047075 062775
2.190.35	cancellous screw; Ø 6.5 x 35; fully threaded; stainless steel	 4 047075 062904
2.190.40	cancellous screw; Ø 6.5 x 40; fully threaded; stainless steel	 4 047075 062911
2.190.42	cancellous screw; Ø 6.5 x 42; fully threaded; stainless steel	 4 047075 062799
2.190.44	cancellous screw; Ø 6.5 x 44; fully threaded; stainless steel	 4 047075 062805
2.190.45	cancellous screw; Ø 6.5 x 45; fully threaded; stainless steel	 4 047075 062706
2.190.46	cancellous screw; Ø 6.5 x 46; fully threaded; stainless steel	 4 047075 062713
2.190.48	cancellous screw; Ø 6.5 x 48; fully threaded; stainless steel	 4 047075 062829
2.190.50	cancellous screw; Ø 6.5 x 50; fully threaded; stainless steel	 4 047075 062744
2.190.52	cancellous screw; Ø 6.5 x 52; fully threaded; stainless steel	 4 047075 062751
2.190.54	cancellous screw; Ø 6.5 x 54; fully threaded; stainless steel	 4 047075 062768
2.190.55	cancellous screw; Ø 6.5 x 55; fully threaded; stainless steel	 4 047075 062645
2.190.56	cancellous screw; Ø 6.5 x 56; fully threaded; stainless steel	 4 047075 062782
2.190.60	cancellous screw; Ø 6.5 x 60; fully threaded; stainless steel	 4 047075 062676
2.190.65	cancellous screw; Ø 6.5 x 65; fully threaded; stainless steel	 4 047075 062683
2.190.70	cancellous screw; Ø 6.5 x 70; fully threaded; stainless steel	 4 047075 062690
2.190.75	cancellous screw; Ø 6.5 x 75; fully threaded; stainless steel	 4 047075 062607
2.190.80	cancellous screw; Ø 6.5 x 80; fully threaded; stainless steel	 4 047075 062720
2.190.85	cancellous screw; Ø 6.5 x 85; fully threaded; stainless steel	 4 047075 062737
2.190.90	cancellous screw; Ø 6.5 x 90; fully threaded; stainless steel	 4 047075 062621
2.190.95	cancellous screw; Ø 6.5 x 95; fully threaded; stainless steel	 4 047075 062638
2.190.100	cancellous screw; Ø 6.5 x 100; fully threaded; stainless steel	 4 047075 062935
2.190.105	cancellous screw; Ø 6.5 x 105; fully threaded; stainless steel	 4 047075 062942
2.190.110	cancellous screw; Ø 6.5 x 110; fully threaded; stainless steel	 4 047075 062959
2.190.115	cancellous screw; Ø 6.5 x 115; fully threaded; stainless steel	 4 047075 062812
2.190.120	cancellous screw; Ø 6.5 x 120; fully threaded; stainless steel	 4 047075 062973
2.190.125	cancellous screw; Ø 6.5 x 125; fully threaded; stainless steel	 4 047075 111152
2.190.130	cancellous screw; Ø 6.5 x 130; fully threaded; stainless steel	 4 047075 111978
2.190.135	cancellous screw; Ø 6.5 x 135; fully threaded; stainless steel	 4 047075 126286
2.190.140	cancellous screw; Ø 6.5 x 140; fully threaded; stainless steel	4 047075 126293

Cortical screw

angle-stable; titanium



Item no. 3.114.14



Item no. 3.114.20

Item no.	Item description	EAN
Cortical screw Ø 2.0 mm; angle-stable; titanium		
3.114.06	Cortical screw with conical head thread and depth stop; Ø 2.0 x 6.0 mm; fully threaded; self tapping; titanium	4 047075 127542
3.114.07	Cortical screw with conical head thread and depth stop; Ø 2.0 x 7.0 mm; fully threaded; self tapping; titanium	4 047075 127559
3.114.08	Cortical screw with conical head thread and depth stop; Ø 2.0 x 8.0 mm; fully threaded; self tapping; titanium	4 047075 127566
3.114.09	Cortical screw with conical head thread and depth stop; Ø 2.0 x 9.0 mm; fully threaded; self tapping; titanium	4 047075 127573
3.114.10	Cortical screw with conical head thread and depth stop; Ø 2.0 x 10 mm; fully threaded; self tapping; titanium	4 047075 127580
3.114.11	Cortical screw with conical head thread and depth stop; Ø 2.0 x 11 mm; fully threaded; self tapping; titanium	4 047075 127597
3.114.12	Cortical screw with conical head thread and depth stop; Ø 2.0 x 12 mm; fully threaded; self tapping; titanium	4 047075 127603
3.114.13	Cortical screw with conical head thread and depth stop; Ø 2.0 x 13 mm; fully threaded; self tapping; titanium	4 047075 127610
3.114.14	Cortical screw with conical head thread and depth stop; Ø 2.0 x 14 mm; fully threaded; self tapping; titanium	4 047075 127627
3.114.15	Cortical screw with conical head thread and depth stop; Ø 2.0 x 15 mm; fully threaded; self tapping; titanium	4 047075 127634
3.114.16	Cortical screw with conical head thread and depth stop; Ø 2.0 x 16 mm; fully threaded; self tapping; titanium	4 047075 127641
3.114.18	Cortical screw with conical head thread and depth stop; Ø 2.0 x 18 mm; fully threaded; self tapping; titanium	4 047075 128136
3.114.20	Cortical screw with conical head thread and depth stop; Ø 2.0 x 20 mm; fully threaded; self tapping; titanium	4 047075 128143
3.114.22	Cortical screw with conical head thread and depth stop; Ø 2.0 x 22 mm; fully threaded; self tapping; titanium	4 047075 128150
3.114.24	Cortical screw with conical head thread and depth stop; Ø 2.0 x 24 mm; fully threaded; self tapping; titanium	4 047075 128167
3.114.26	Cortical screw with conical head thread and depth stop; Ø 2.0 x 26 mm; fully threaded; self tapping; titanium	4 047075 128174
3.114.28	Cortical screw with conical head thread and depth stop; Ø 2.0 x 28 mm; fully threaded; self tapping; titanium	4 047075 128181
3.114.30	Cortical screw with conical head thread and depth stop; Ø 2.0 x 30 mm; fully threaded; self tapping; titanium	4 047075 128198

Cortical screw

angle-stable; titanium



Item no. 3.0124.20



Item no. 3.125.10

Item no.	Item description	EAN
Cortical screw Ø 2.4 mm; angle-stable; titanium		
3.0124.10	Cortical screw; Ø 2.4 x 10 mm; angle-stable; fully threaded; self tapping; titanium	4 047075 177912
3.0124.12	Cortical screw; Ø 2.4 x 12 mm; angle-stable; fully threaded; self tapping; titanium	4 047075 177929
3.0124.14	Cortical screw; Ø 2.4 x 14 mm; angle-stable; fully threaded; self tapping; titanium	4 047075 177936
3.0124.16	Cortical screw; Ø 2.4 x 16 mm; angle-stable; fully threaded; self tapping; titanium	4 047075 177943
3.0124.18	Cortical screw; Ø 2.4 x 18 mm; angle-stable; fully threaded; self tapping; titanium	4 047075 177950
3.0124.20	Cortical screw; Ø 2.4 x 20 mm; angle-stable; fully threaded; self tapping; titanium	4 047075 177967
3.0124.22	Cortical screw; Ø 2.4 x 22 mm; angle-stable; fully threaded; self tapping; titanium	4 047075 177974
3.0124.24	Cortical screw; Ø 2.4 x 24 mm; angle-stable; fully threaded; self tapping; titanium	4 047075 177981
3.0124.26	Cortical screw; Ø 2.4 x 26 mm; angle-stable; fully threaded; self tapping; titanium	4 047075 177998
3.0124.28	Cortical screw; Ø 2.4 x 28 mm; angle-stable; fully threaded; self tapping; titanium	4 047075 178001
Cortical screw Ø 2.7 mm; angle-stable; head Ø 5.0 mm; titanium		
3.125.08	Cortical screw with conical head thread; Ø 2.7 x 8.0 mm; fully threaded; self tapping; head Ø 5.0 mm; titanium	4 047075 128211
3.125.10	Cortical screw with conical head thread; Ø 2.7 x 10 mm; fully threaded; self tapping; head Ø 5.0 mm; titanium	4 047075 115297
3.125.12	Cortical screw with conical head thread; Ø 2.7 x 12 mm; fully threaded; self tapping; head Ø 5.0 mm; titanium	4 047075 115303
3.125.13	Cortical screw with conical head thread; Ø 2.7 x 13 mm; fully threaded; self tapping; head Ø 5.0 mm; titanium	4 047075 147380
3.125.14	Cortical screw with conical head thread; Ø 2.7 x 14 mm; fully threaded; self tapping; head Ø 5.0 mm; titanium	4 047075 115341
3.125.15	Cortical screw with conical head thread; Ø 2.7 x 15 mm; fully threaded; self tapping; head Ø 5.0 mm; titanium	4 047075 147397
3.125.16	Cortical screw with conical head thread; Ø 2.7 x 16 mm; fully threaded; self tapping; head Ø 5.0 mm; titanium	4 047075 115358
3.125.17	Cortical screw with conical head thread; Ø 2.7 x 17 mm; fully threaded; self tapping; head Ø 5.0 mm; titanium	4 047075 147403
3.125.18	Cortical screw with conical head thread; Ø 2.7 x 18 mm; fully threaded; self tapping; head Ø 5.0 mm; titanium	4 047075 115365

Cortical screw

angle-stable; titanium



Item no. 3.125.20



Item no. 3.125.30

Item no.	Item description	EAN
Cortical screw Ø 2.7 mm; angle-stable; head Ø 5.0 mm; titanium		
3.125.19	Cortical screw with conical head thread; Ø 2.7 x 19 mm; fully threaded; self tapping; head Ø 5.0 mm; titanium	4 047075 147410
3.125.20	Cortical screw with conical head thread; Ø 2.7 x 20 mm; fully threaded; self tapping; head Ø 5.0 mm; titanium	4 047075 115372
3.125.21	Cortical screw with conical head thread; Ø 2.7 x 21 mm; fully threaded; self tapping; head Ø 5.0 mm; titanium	4 047075 147427
3.125.22	Cortical screw with conical head thread; Ø 2.7 x 22 mm; fully threaded; self tapping; head Ø 5.0 mm; titanium	4 047075 115389
3.125.23	Cortical screw with conical head thread; Ø 2.7 x 23 mm; fully threaded; self tapping; head Ø 5.0 mm; titanium	4 047075 147434
3.125.24	Cortical screw with conical head thread; Ø 2.7 x 24 mm; fully threaded; self tapping; head Ø 5.0 mm; titanium	4 047075 115396
3.125.25	Cortical screw with conical head thread; Ø 2.7 x 25 mm; fully threaded; self tapping; head Ø 5.0 mm; titanium	4 047075 147441
3.125.26	Cortical screw with conical head thread; Ø 2.7 x 26 mm; fully threaded; self tapping; head Ø 5.0 mm; titanium	4 047075 115402
3.125.27	Cortical screw with conical head thread; Ø 2.7 x 27 mm; fully threaded; self tapping; head Ø 5.0 mm; titanium	4 047075 147458
3.125.28	Cortical screw with conical head thread; Ø 2.7 x 28 mm; fully threaded; self tapping; head Ø 5.0 mm; titanium	4 047075 115419
3.125.29	Cortical screw with conical head thread; Ø 2.7 x 29 mm; fully threaded; self tapping; head Ø 5.0 mm; titanium	4 047075 147465
3.125.30	Cortical screw with conical head thread; Ø 2.7 x 30 mm; fully threaded; self tapping; head Ø 5.0 mm; titanium	4 047075 115426
3.125.31	Cortical screw with conical head thread; Ø 2.7 x 31 mm; fully threaded; self tapping; head Ø 5.0 mm; titanium	4 047075 147472
3.125.32	Cortical screw with conical head thread; Ø 2.7 x 32 mm; fully threaded; self tapping; head Ø 5.0 mm; titanium	4 047075 115433
3.125.33	Cortical screw with conical head thread; Ø 2.7 x 33 mm; fully threaded; self tapping; head Ø 5.0 mm; titanium	4 047075 147489
3.125.34	Cortical screw with conical head thread; Ø 2.7 x 34 mm; fully threaded; self tapping; head Ø 5.0 mm; titanium	4 047075 115440
3.125.36	Cortical screw with conical head thread; Ø 2.7 x 36 mm; fully threaded; self tapping; head Ø 5.0 mm; titanium	4 047075 115457

Cortical screw

angle-stable; titanium



Item no. 3.125.30



Item no. 3.1251.20

Item no.	Item description	EAN
Cortical screw Ø 2.7 mm; angle-stable; head Ø 5.0 mm; titanium		
3.125.38	Cortical screw with conical head thread; Ø 2.7 x 38 mm; fully threaded; self tapping; head Ø 5.0 mm; titanium	4 047075 115464
3.125.40	Cortical screw with conical head thread; Ø 2.7 x 40 mm; fully threaded; self tapping; head Ø 5.0 mm; titanium	4 047075 115471
3.125.45	Cortical screw with conical head thread; Ø 2.7 x 45 mm; fully threaded; self tapping; head Ø 5.0 mm; titanium	4 047075 133055
3.125.50	Cortical screw with conical head thread; Ø 2.7 x 50 mm; fully threaded; self tapping; head Ø 5.0 mm; titanium	4 047075 133062
Cortical screw Ø 2.7 mm; angle-stable; six lobe 10; titanium		
3.1251.08	Cortical screw with conical head thread; Ø 2.7 x 8.0 mm; fully threaded; self tapping; six lobe 10; titanium	4 047075 144310
3.1251.10	Cortical screw with conical head thread; Ø 2.7 x 10 mm; fully threaded; self tapping; six lobe 10; titanium	4 047075 142590
3.1251.12	Cortical screw with conical head thread; Ø 2.7 x 12 mm; fully threaded; self tapping; six lobe 10; titanium	4 047075 142606
3.1251.13	Cortical screw with conical head thread; Ø 2.7 x 13 mm; fully threaded; self tapping; six lobe 10; titanium	4 047075 150243
3.1251.14	Cortical screw with conical head thread; Ø 2.7 x 14 mm; fully threaded; self tapping; six lobe 10; titanium	4 047075 142613
3.1251.15	Cortical screw with conical head thread; Ø 2.7 x 15 mm; fully threaded; self tapping; six lobe 10; titanium	4 047075 150250
3.1251.16	Cortical screw with conical head thread; Ø 2.7 x 16 mm; fully threaded; self tapping; six lobe 10; titanium	4 047075 142620
3.1251.17	Cortical screw with conical head thread; Ø 2.7 x 17 mm; fully threaded; self tapping; six lobe 10; titanium	4 047075 150267
3.1251.18	Cortical screw with conical head thread; Ø 2.7 x 18 mm; fully threaded; self tapping; six lobe 10; titanium	4 047075 142637
3.1251.19	Cortical screw with conical head thread; Ø 2.7 x 19 mm; fully threaded; self tapping; six lobe 10; titanium	4 047075 150274
3.1251.20	Cortical screw with conical head thread; Ø 2.7 x 20 mm; fully threaded; self tapping; six lobe 10; titanium	4 047075 142644

Cortical screw

angle-stable; titanium



Item no. 3.1251.20



Item no. 3.1251.24

Item no.	Item description	EAN
Cortical screw Ø 2.7 mm; angle-stable; six lobe 10; titanium		
3.1251.21	Cortical screw with conical head thread; Ø 2.7 x 21 mm; fully threaded; self tapping; six lobe 10; titanium	4 047075 150281
3.1251.22	Cortical screw with conical head thread; Ø 2.7 x 22 mm; fully threaded; self tapping; six lobe 10; titanium	4 047075 142651
3.1251.23	Cortical screw with conical head thread; Ø 2.7 x 23 mm; fully threaded; self tapping; six lobe 10; titanium	4 047075 150298
3.1251.24	Cortical screw with conical head thread; Ø 2.7 x 24 mm; fully threaded; self tapping; six lobe 10; titanium	4 047075 142668
3.1251.25	Cortical screw with conical head thread; Ø 2.7 x 25 mm; fully threaded; self tapping; six lobe 10; titanium	4 047075 150304
3.1251.26	Cortical screw with conical head thread; Ø 2.7 x 26 mm; fully threaded; self tapping; six lobe 10; titanium	4 047075 142675
3.1251.27	Cortical screw with conical head thread; Ø 2.7 x 27 mm; fully threaded; self tapping; six lobe 10; titanium	4 047075 150311
3.1251.28	Cortical screw with conical head thread; Ø 2.7 x 28 mm; fully threaded; self tapping; six lobe 10; titanium	4 047075 142682
3.1251.29	Cortical screw with conical head thread; Ø 2.7 x 29 mm; fully threaded; self tapping; six lobe 10; titanium	4 047075 150328
3.1251.30	Cortical screw with conical head thread; Ø 2.7 x 30 mm; fully threaded; self tapping; six lobe 10; titanium	4 047075 142699
3.1251.31	Cortical screw with conical head thread; Ø 2.7 x 31 mm; fully threaded; self tapping; six lobe 10; titanium	4 047075 150335
3.1251.32	Cortical screw with conical head thread; Ø 2.7 x 32 mm; fully threaded; self tapping; six lobe 10; titanium	4 047075 142705
3.1251.33	Cortical screw with conical head thread; Ø 2.7 x 33 mm; fully threaded; self tapping; six lobe 10; titanium	4 047075 150342
3.1251.34	Cortical screw with conical head thread; Ø 2.7 x 34 mm; fully threaded; self tapping; six lobe 10; titanium	4 047075 142712
3.1251.36	Cortical screw with conical head thread; Ø 2.7 x 36 mm; fully threaded; self tapping; six lobe 10; titanium	4 047075 142729
3.1251.38	Cortical screw with conical head thread; Ø 2.7 x 38 mm; fully threaded; self tapping; six lobe 10; titanium	4 047075 142736
3.1251.40	Cortical screw with conical head thread; Ø 2.7 x 40 mm; fully threaded; self tapping; six lobe 10; titanium	4 047075 142743

Cortical screw

angle-stable; titanium



Item no. 3.133.16



Item no. 3.133.30

Item no.	Item description	EAN
Cortical screw Ø 3.5 mm; angle-stable; titanium		
3.133.10	Cortical screw with conical head thread; Ø 3.5 x 10 mm; fully threaded; self tapping; titanium	4 047075 089673
3.133.12	Cortical screw with conical head thread; Ø 3.5 x 12 mm; fully threaded; self tapping; titanium	4 047075 089697
3.133.14	Cortical screw with conical head thread; Ø 3.5 x 14 mm; fully threaded; self tapping; titanium	4 047075 089536
3.133.16	Cortical screw with conical head thread; Ø 3.5 x 16 mm; fully threaded; self tapping; titanium	4 047075 089550
3.133.18	Cortical screw with conical head thread; Ø 3.5 x 18 mm; fully threaded; self tapping; titanium	4 047075 089574
3.133.20	Cortical screw with conical head thread; Ø 3.5 x 20 mm; fully threaded; self tapping; titanium	4 047075 089598
3.133.22	Cortical screw with conical head thread; Ø 3.5 x 22 mm; fully threaded; self tapping; titanium	4 047075 089901
3.133.24	Cortical screw with conical head thread; Ø 3.5 x 24 mm; fully threaded; self tapping; titanium	4 047075 089925
3.133.26	Cortical screw with conical head thread; Ø 3.5 x 26 mm; fully threaded; self tapping; titanium	4 047075 089727
3.133.28	Cortical screw with conical head thread; Ø 3.5 x 28 mm; fully threaded; self tapping; titanium	4 047075 089956
3.133.30	Cortical screw with conical head thread; Ø 3.5 x 30 mm; fully threaded; self tapping; titanium	4 047075 089765
3.133.32	Cortical screw with conical head thread; Ø 3.5 x 32 mm; fully threaded; self tapping; titanium	4 047075 089789
3.133.34	Cortical screw with conical head thread; Ø 3.5 x 34 mm; fully threaded; self tapping; titanium	4 047075 089802
3.133.35	Cortical screw with conical head thread; Ø 3.5 x 35 mm; fully threaded; self tapping; titanium	4 047075 089826
3.133.36	Cortical screw with conical head thread; Ø 3.5 x 36 mm; fully threaded; self tapping; titanium	4 047075 089642
3.133.38	Cortical screw with conical head thread; Ø 3.5 x 38 mm; fully threaded; self tapping; titanium	4 047075 090112
3.133.40	Cortical screw with conical head thread; Ø 3.5 x 40 mm; fully threaded; self tapping; titanium	4 047075 089963

Cortical screw

angle-stable; titanium



Item no. 3.133.30



Item no. 3.133.42

Item no.	Item description	EAN
Cortical screw Ø 3.5 mm; angle-stable; titanium		
3.133.42	Cortical screw with conical head thread; Ø 3.5 x 42 mm; fully threaded; self tapping; titanium	4 ⁰ 047075 ⁰ 089987
3.133.44	Cortical screw with conical head thread; Ø 3.5 x 44 mm; fully threaded; self tapping; titanium	4 ⁰ 047075 ⁰ 090006
3.133.45	Cortical screw with conical head thread; Ø 3.5 x 45 mm; fully threaded; self tapping; titanium	4 ⁰ 047075 ⁰ 090013
3.133.46	Cortical screw with conical head thread; Ø 3.5 x 46 mm; fully threaded; self tapping; titanium	4 ⁰ 047075 ⁰ 169924
3.133.48	Cortical screw with conical head thread; Ø 3.5 x 48 mm; fully threaded; self tapping; titanium	4 ⁰ 047075 ⁰ 090037
3.133.50	Cortical screw with conical head thread; Ø 3.5 x 50 mm; fully threaded; self tapping; titanium	4 ⁰ 047075 ⁰ 089833
3.133.52	Cortical screw with conical head thread; Ø 3.5 x 52 mm; fully threaded; self tapping; titanium	4 ⁰ 047075 ⁰ 169931
3.133.54	Cortical screw with conical head thread; Ø 3.5 x 54 mm; fully threaded; self tapping; titanium	4 ⁰ 047075 ⁰ 169948
3.133.55	Cortical screw with conical head thread; Ø 3.5 x 55 mm; fully threaded; self tapping; titanium	4 ⁰ 047075 ⁰ 090051
3.133.56	Cortical screw with conical head thread; Ø 3.5 x 56 mm; fully threaded; self tapping; titanium	4 ⁰ 047075 ⁰ 169955
3.133.58	Cortical screw with conical head thread; Ø 3.5 x 58 mm; fully threaded; self tapping; titanium	4 ⁰ 047075 ⁰ 169962
3.133.60	Cortical screw with conical head thread; Ø 3.5 x 60 mm; fully threaded; self tapping; titanium	4 ⁰ 047075 ⁰ 090068
3.133.65	Cortical screw with conical head thread; Ø 3.5 x 65 mm; fully threaded; self tapping; titanium	4 ⁰ 047075 ⁰ 089864
3.133.70	Cortical screw with conical head thread; Ø 3.5 x 70 mm; fully threaded; self tapping; titanium	4 ⁰ 047075 ⁰ 089888

Cortical screw

angle-stable; titanium



Item no. 3.136.16



Item no. 3.136.40

Item no.	Item description	EAN
Cortical screw Ø 3.5 mm; angle-stable; titanium		
3.136.10	Cortical screw with conical head thread; Ø 3.5 x 10 mm; fully threaded; self tapping; head Ø 5.0 mm; titanium	4 047075 128228
3.136.12	Cortical screw with conical head thread; Ø 3.5 x 12 mm; fully threaded; self tapping; head Ø 5.0 mm; titanium	4 047075 128235
3.136.14	Cortical screw with conical head thread; Ø 3.5 x 14 mm; fully threaded; self tapping; head Ø 5.0 mm; titanium	4 047075 128242
3.136.16	Cortical screw with conical head thread; Ø 3.5 x 16 mm; fully threaded; self tapping; head Ø 5.0 mm; titanium	4 047075 128259
3.136.18	Cortical screw with conical head thread; Ø 3.5 x 18 mm; fully threaded; self tapping; head Ø 5.0 mm; titanium	4 047075 128266
3.136.20	Cortical screw with conical head thread; Ø 3.5 x 20 mm; fully threaded; self tapping; head Ø 5.0 mm; titanium	4 047075 128273
3.136.22	Cortical screw with conical head thread; Ø 3.5 x 22 mm; fully threaded; self tapping; head Ø 5.0 mm; titanium	4 047075 128570
3.136.24	Cortical screw with conical head thread; Ø 3.5 x 24 mm; fully threaded; self tapping; head Ø 5.0 mm; titanium	4 047075 128587
3.136.26	Cortical screw with conical head thread; Ø 3.5 x 26 mm; fully threaded; self tapping; head Ø 5.0 mm; titanium	4 047075 128594
3.136.28	Cortical screw with conical head thread; Ø 3.5 x 28 mm; fully threaded; self tapping; head Ø 5.0 mm; titanium	4 047075 128600
3.136.30	Cortical screw with conical head thread; Ø 3.5 x 30 mm; fully threaded; self tapping; head Ø 5.0 mm; titanium	4 047075 128617
3.136.32	Cortical screw with conical head thread; Ø 3.5 x 32 mm; fully threaded; self tapping; head Ø 5.0 mm; titanium	4 047075 128624
3.136.34	Cortical screw with conical head thread; Ø 3.5 x 34 mm; fully threaded; self tapping; head Ø 5.0 mm; titanium	4 047075 128631
3.136.36	Cortical screw with conical head thread; Ø 3.5 x 36 mm; fully threaded; self tapping; head Ø 5.0 mm; titanium	4 047075 128648
3.136.38	Cortical screw with conical head thread; Ø 3.5 x 38 mm; fully threaded; self tapping; head Ø 5.0 mm; titanium	4 047075 128655
3.136.40	Cortical screw with conical head thread; Ø 3.5 x 40 mm; fully threaded; self tapping; head Ø 5.0 mm; titanium	4 047075 128662

Cortical screw

angle-stable; titanium



Item no. 3.148.26



Item no. 3.148.40

Item no.	Item description	EAN
Cortical screw Ø 4.0 mm; angle-stable; titanium		
3.148.10	Cortical screw with conical head thread; Ø 4.0 x 10 mm; self tapping; titanium	4 047075 156139
3.148.12	Cortical screw with conical head thread; Ø 4.0 x 12 mm; self tapping; titanium	4 047075 156146
3.148.14	Cortical screw with conical head thread; Ø 4.0 x 14 mm; self tapping; titanium	4 047075 156153
3.148.16	Cortical screw with conical head thread; Ø 4.0 x 16 mm; self tapping; titanium	4 047075 156160
3.148.18	Cortical screw with conical head thread; Ø 4.0 x 18 mm; self tapping; titanium	4 047075 156177
3.148.20	Cortical screw with conical head thread; Ø 4.0 x 20 mm; self tapping; titanium	4 047075 145843
3.148.22	Cortical screw with conical head thread; Ø 4.0 x 22 mm; self tapping; titanium	4 047075 145850
3.148.24	Cortical screw with conical head thread; Ø 4.0 x 24 mm; self tapping; titanium	4 047075 136766
3.148.26	Cortical screw with conical head thread; Ø 4.0 x 26 mm; self tapping; titanium	4 047075 145867
3.148.28	Cortical screw with conical head thread; Ø 4.0 x 28 mm; self tapping; titanium	4 047075 145874
3.148.30	Cortical screw with conical head thread; Ø 4.0 x 30 mm; self tapping; titanium	4 047075 136773
3.148.32	Cortical screw with conical head thread; Ø 4.0 x 32 mm; self tapping; titanium	4 047075 145881
3.148.34	Cortical screw with conical head thread; Ø 4.0 x 34 mm; self tapping; titanium	4 047075 145898
3.148.36	Cortical screw with conical head thread; Ø 4.0 x 36 mm; self tapping; titanium	4 047075 136780
3.148.38	Cortical screw with conical head thread; Ø 4.0 x 38 mm; self tapping; titanium	4 047075 145904
3.148.40	Cortical screw with conical head thread; Ø 4.0 x 40 mm; self tapping; titanium	4 047075 145911
3.148.42	Cortical screw with conical head thread; Ø 4.0 x 42 mm; self tapping; titanium	4 047075 136797
3.148.44	Cortical screw with conical head thread; Ø 4.0 x 44 mm; self tapping; titanium	4 047075 145928
3.148.45	Cortical screw with conical head thread; Ø 4.0 x 45 mm; self tapping; titanium	4 047075 156184
3.148.46	Cortical screw with conical head thread; Ø 4.0 x 46 mm; self tapping; titanium	4 047075 145935
3.148.48	Cortical screw with conical head thread; Ø 4.0 x 48 mm; self tapping; titanium	4 047075 136803
3.148.50	Cortical screw with conical head thread; Ø 4.0 x 50 mm; self tapping; titanium	4 047075 145942
3.148.52	Cortical screw with conical head thread; Ø 4.0 x 52 mm; self tapping; titanium	4 047075 145959
3.148.54	Cortical screw with conical head thread; Ø 4.0 x 54 mm; self tapping; titanium	4 047075 145966
3.148.55	Cortical screw with conical head thread; Ø 4.0 x 55 mm; self tapping; titanium	4 047075 156191

Cortical screw

angle-stable; titanium











Item no. 3.148.40











Item no. 3.0140.30

Item no.	Item description	EAN
----------	------------------	-----

Cortical screw Ø 4.0 mm; angle-stable; titanium

3.148.56	Cortical screw with conical head thread; Ø 4.0 x 56 mm; self tapping; titanium	
3.148.58	Cortical screw with conical head thread; Ø 4.0 x 58 mm; self tapping; titanium	
3.148.60	Cortical screw with conical head thread; Ø 4.0 x 60 mm; self tapping; titanium	
3.148.65	Cortical screw with conical head thread; Ø 4.0 x 65 mm; self tapping; titanium	
3.148.70	Cortical screw with conical head thread; Ø 4.0 x 70 mm; self tapping; titanium	
3.148.75	Cortical screw with conical head thread; Ø 4.0 x 75 mm; self tapping; titanium	
3.148.80	Cortical screw with conical head thread; Ø 4.0 x 80 mm; self tapping; titanium	
3.148.85	Cortical screw with conical head thread; Ø 4.0 x 85 mm; self tapping; titanium	
3.148.90	Cortical screw with conical head thread; Ø 4.0 x 90 mm; self tapping; titanium	

Cortical screw Ø 4.0 mm; angle-stable; six lobe 15; titanium

3.0140.10	Cortical screw; Ø 4.0 x 10 mm; angle-stable; fully threaded; self tapping; six lobe 15; titanium	
3.0140.12	Cortical screw; Ø 4.0 x 12 mm; angle-stable; fully threaded; self tapping; six lobe 15; titanium	
3.0140.14	Cortical screw; Ø 4.0 x 14 mm; angle-stable; fully threaded; self tapping; six lobe 15; titanium	
3.0140.16	Cortical screw; Ø 4.0 x 16 mm; angle-stable; fully threaded; self tapping; six lobe 15; titanium	
3.0140.18	Cortical screw; Ø 4.0 x 18 mm; angle-stable; fully threaded; self tapping; six lobe 15; titanium	
3.0140.20	Cortical screw; Ø 4.0 x 20 mm; angle-stable; fully threaded; self tapping; six lobe 15; titanium	
3.0140.22	Cortical screw; Ø 4.0 x 22 mm; angle-stable; fully threaded; self tapping; six lobe 15; titanium	
3.0140.24	Cortical screw; Ø 4.0 x 24 mm; angle-stable; fully threaded; self tapping; six lobe 15; titanium	
3.0140.26	Cortical screw; Ø 4.0 x 26 mm; angle-stable; fully threaded; self tapping; six lobe 15; titanium	
3.0140.28	Cortical screw; Ø 4.0 x 28 mm; angle-stable; fully threaded; self tapping; six lobe 15; titanium	

Cortical screw

angle-stable; titanium



Item no. 3.0140.30



Item no. 3.0140.60

Item no.	Item description	EAN
Cortical screw Ø 4.0 mm; angle-stable; six lobe 15; titanium		
3.0140.30	Cortical screw; Ø 4.0 x 30 mm; angle-stable; fully threaded; self tapping; six lobe 15; titanium	4 047075 189236
3.0140.32	Cortical screw; Ø 4.0 x 32 mm; angle-stable; fully threaded; self tapping; six lobe 15; titanium	4 047075 189243
3.0140.34	Cortical screw; Ø 4.0 x 34 mm; angle-stable; fully threaded; self tapping; six lobe 15; titanium	4 047075 189250
3.0140.36	Cortical screw; Ø 4.0 x 36 mm; angle-stable; fully threaded; self tapping; six lobe 15; titanium	4 047075 189267
3.0140.38	Cortical screw; Ø 4.0 x 38 mm; angle-stable; fully threaded; self tapping; six lobe 15; titanium	4 047075 189274
3.0140.40	Cortical screw; Ø 4.0 x 40 mm; angle-stable; fully threaded; self tapping; six lobe 15; titanium	4 047075 189281
3.0140.42	Cortical screw; Ø 4.0 x 42 mm; angle-stable; fully threaded; self tapping; six lobe 15; titanium	4 047075 189298
3.0140.44	Cortical screw; Ø 4.0 x 44 mm; angle-stable; fully threaded; self tapping; six lobe 15; titanium	4 047075 189304
3.0140.46	Cortical screw; Ø 4.0 x 46 mm; angle-stable; fully threaded; self tapping; six lobe 15; titanium	4 047075 189328
3.0140.48	Cortical screw; Ø 4.0 x 48 mm; angle-stable; fully threaded; self tapping; six lobe 15; titanium	4 047075 189335
3.0140.50	Cortical screw; Ø 4.0 x 50 mm; angle-stable; fully threaded; self tapping; six lobe 15; titanium	4 047075 189342
3.0140.52	Cortical screw; Ø 4.0 x 52 mm; angle-stable; fully threaded; self tapping; six lobe 15; titanium	4 047075 189359
3.0140.54	Cortical screw; Ø 4.0 x 54 mm; angle-stable; fully threaded; self tapping; six lobe 15; titanium	4 047075 189366
3.0140.56	Cortical screw; Ø 4.0 x 56 mm; angle-stable; fully threaded; self tapping; six lobe 15; titanium	4 047075 189380
3.0140.58	Cortical screw; Ø 4.0 x 58 mm; angle-stable; fully threaded; self tapping; six lobe 15; titanium	4 047075 189397
3.0140.60	Cortical screw; Ø 4.0 x 60 mm; angle-stable; fully threaded; self tapping; six lobe 15; titanium	4 047075 189403
3.0140.65	Cortical screw; Ø 4.0 x 65 mm; angle-stable; fully threaded; self tapping; six lobe 15; titanium	4 047075 189410

Cortical screw

angle-stable; titanium



Item no. 3.0140.60



Item no. 3.545.30

Item no.	Item description	EAN
Cortical screw Ø 4.0 mm; angle-stable; six lobe 15; titanium		
3.0140.70	Cortical screw; Ø 4.0 x 70 mm; angle-stable; fully threaded; self tapping; six lobe 15; titanium	4 047075 189427
3.0140.75	Cortical screw; Ø 4.0 x 75 mm; angle-stable; fully threaded; self tapping; six lobe 15; titanium	4 047075 189434
3.0140.80	Cortical screw; Ø 4.0 x 80 mm; angle-stable; fully threaded; self tapping; six lobe 15; titanium	4 047075 189441
3.0140.85	Cortical screw; Ø 4.0 x 85 mm; angle-stable; fully threaded; self tapping; six lobe 15; titanium	4 047075 189458
3.0140.90	Cortical screw; Ø 4.0 x 90 mm; angle-stable; fully threaded; self tapping; six lobe 15; titanium	4 047075 189465
Cortical screw Ø 4.5 mm; angle-stable; titanium		
3.545.12	Cortical screw with conical head thread; Ø 4.5 x 12 mm; fully threaded; self tapping; titanium	4 047075 132980
3.545.14	Cortical screw with conical head thread; Ø 4.5 x 14 mm; fully threaded; self tapping; titanium	4 047075 132997
3.545.16	Cortical screw with conical head thread; Ø 4.5 x 16 mm; fully threaded; self tapping; titanium	4 047075 124538
3.545.18	Cortical screw with conical head thread; Ø 4.5 x 18 mm; fully threaded; self tapping; titanium	4 047075 100453
3.545.20	Cortical screw with conical head thread; Ø 4.5 x 20 mm; fully threaded; self tapping; titanium	4 047075 100583
3.545.22	Cortical screw with conical head thread; Ø 4.5 x 22 mm; fully threaded; self tapping; titanium	4 047075 100477
3.545.24	Cortical screw with conical head thread; Ø 4.5 x 24 mm; fully threaded; self tapping; titanium	4 047075 100668
3.545.26	Cortical screw with conical head thread; Ø 4.5 x 26 mm; fully threaded; self tapping; titanium	4 047075 100675
3.545.28	Cortical screw with conical head thread; Ø 4.5 x 28 mm; fully threaded; self tapping; titanium	4 047075 100569
3.545.30	Cortical screw with conical head thread; Ø 4.5 x 30 mm; fully threaded; self tapping; titanium	4 047075 100576
3.545.32	Cortical screw with conical head thread; Ø 4.5 x 32 mm; fully threaded; self tapping; titanium	4 047075 100590

Cortical screw

angle-stable; titanium



Item no. 3.545.30

Item no.	Item description	EAN
Cortical screw Ø 4.5 mm; angle-stable; titanium		
3.545.34	Cortical screw with conical head thread; Ø 4.5 x 34 mm; fully threaded; self tapping; titanium	4 ⁰ 047075 ¹ 100606
3.545.36	Cortical screw with conical head thread; Ø 4.5 x 36 mm; fully threaded; self tapping; titanium	4 ⁰ 047075 ¹ 100613
3.545.38	Cortical screw with conical head thread; Ø 4.5 x 38 mm; fully threaded; self tapping; titanium	4 ⁰ 047075 ¹ 100620
3.545.40	Cortical screw with conical head thread; Ø 4.5 x 40 mm; fully threaded; self tapping; titanium	4 ⁰ 047075 ¹ 100682
3.545.42	Cortical screw with conical head thread; Ø 4.5 x 42 mm; fully threaded; self tapping; titanium	4 ⁰ 047075 ¹ 100811
3.545.44	Cortical screw with conical head thread; Ø 4.5 x 44 mm; fully threaded; self tapping; titanium	4 ⁰ 047075 ¹ 100699
3.545.45	Cortical screw with conical head thread; Ø 4.5 x 45 mm; fully threaded; self tapping; titanium	4 ⁰ 047075 ¹ 059294
3.545.46	Cortical screw with conical head thread; Ø 4.5 x 46 mm; fully threaded; self tapping; titanium	4 ⁰ 047075 ¹ 100705
3.545.48	Cortical screw with conical head thread; Ø 4.5 x 48 mm; fully threaded; self tapping; titanium	4 ⁰ 047075 ¹ 126385
3.545.50	Cortical screw with conical head thread; Ø 4.5 x 50 mm; fully threaded; self tapping; titanium	4 ⁰ 047075 ¹ 100712
3.545.52	Cortical screw with conical head thread; Ø 4.5 x 52 mm; fully threaded; self tapping; titanium	4 ⁰ 047075 ¹ 126392
3.545.54	Cortical screw with conical head thread; Ø 4.5 x 54 mm; fully threaded; self tapping; titanium	4 ⁰ 047075 ¹ 126408
3.545.55	Cortical screw with conical head thread; Ø 4.5 x 55 mm; fully threaded; self tapping; titanium	4 ⁰ 047075 ¹ 113712
3.545.56	Cortical screw with conical head thread; Ø 4.5 x 56 mm; fully threaded; self tapping; titanium	4 ⁰ 047075 ¹ 126415
3.545.60	Cortical screw with conical head thread; Ø 4.5 x 60 mm; fully threaded; self tapping; titanium	4 ⁰ 047075 ¹ 113729
3.545.65	Cortical screw with conical head thread; Ø 4.5 x 65 mm; fully threaded; self tapping; titanium	4 ⁰ 047075 ¹ 113736
3.545.70	Cortical screw with conical head thread; Ø 4.5 x 70 mm; fully threaded; self tapping; titanium	4 ⁰ 047075 ¹ 121427

Cortical screw

angle-stable; titanium



Item no. 3.545.30



Item no. 3.549.40

Item no.	Item description	EAN
Cortical screw Ø 4.5 mm; angle-stable; titanium		
3.545.75	Cortical screw with conical head thread; Ø 4.5 x 75 mm; fully threaded; self tapping; titanium	4 047075 121434
3.545.80	Cortical screw with conical head thread; Ø 4.5 x 80 mm; fully threaded; self tapping; titanium	4 047075 121441
3.545.85	Cortical screw with conical head thread; Ø 4.5 x 85 mm; fully threaded; self tapping; titanium	4 047075 121458
3.545.90	Cortical screw with conical head thread; Ø 4.5 x 90 mm; fully threaded; self tapping; titanium	4 047075 121465
Cortical screw Ø 5.5 mm; angle-stable; titanium		
3.549.12	Cortical screw with conical head thread; Ø 5.5 x 12 mm; fully threaded; self tapping; titanium	4 047075 156207
3.549.14	Cortical screw with conical head thread; Ø 5.5 x 14 mm; fully threaded; self tapping; titanium	4 047075 156214
3.549.18	Cortical screw with conical head thread; Ø 5.5 x 18 mm; fully threaded; self tapping; titanium	4 047075 156221
3.549.22	Cortical screw with conical head thread; Ø 5.5 x 22 mm; fully threaded; self tapping; titanium	4 047075 156238
3.549.26	Cortical screw with conical head thread; Ø 5.5 x 26 mm; fully threaded; self tapping; titanium	4 047075 156245
3.549.30	Cortical screw with conical head thread; Ø 5.5 x 30 mm; fully threaded; self tapping; titanium	4 047075 156528
3.549.34	Cortical screw with conical head thread; Ø 5.5 x 34 mm; fully threaded; self tapping; titanium	4 047075 156252
3.549.38	Cortical screw with conical head thread; Ø 5.5 x 38 mm; fully threaded; self tapping; titanium	4 047075 156375
3.549.40	Cortical screw with conical head thread; Ø 5.5 x 40 mm; fully threaded; self tapping; titanium	4 047075 139675
3.549.42	Cortical screw with conical head thread; Ø 5.5 x 42 mm; fully threaded; self tapping; titanium	4 047075 156269
3.549.45	Cortical screw with conical head thread; Ø 5.5 x 45 mm; fully threaded; self tapping; titanium	4 047075 139682
3.549.50	Cortical screw with conical head thread; Ø 5.5 x 50 mm; fully threaded; self tapping; titanium	4 047075 139699

Cortical screw









angle-stable; titanium



Item no. 3.549.40



Item no. 3.549.80

Item no.	Item description	EAN
Cortical screw Ø 5.5 mm; angle-stable; titanium		
3.549.55	Cortical screw with conical head thread; Ø 5.5 x 55 mm; fully threaded; self tapping; titanium	 4 ⁰ 047075 ¹ 139705
3.549.60	Cortical screw with conical head thread; Ø 5.5 x 60 mm; fully threaded; self tapping; titanium	 4 ⁰ 047075 ¹ 139712
3.549.65	Cortical screw with conical head thread; Ø 5.5 x 65 mm; fully threaded; self tapping; titanium	 4 ⁰ 047075 ¹ 139729
3.549.70	Cortical screw with conical head thread; Ø 5.5 x 70 mm; fully threaded; self tapping; titanium	 4 ⁰ 047075 ¹ 139736
3.549.75	Cortical screw with conical head thread; Ø 5.5 x 75 mm; fully threaded; self tapping; titanium	 4 ⁰ 047075 ¹ 139743
3.549.80	Cortical screw with conical head thread; Ø 5.5 x 80 mm; fully threaded; self tapping; titanium	 4 ⁰ 047075 ¹ 139750
3.549.85	Cortical screw with conical head thread; Ø 5.5 x 85 mm; fully threaded; self tapping; titanium	 4 ⁰ 047075 ¹ 139767
3.549.90	Cortical screw with conical head thread; Ø 5.5 x 90 mm; fully threaded; self tapping; titanium	 4 ⁰ 047075 ¹ 139774

Cortical screw

angle-stable; stainless steel



Item no. 2.114.14



Item no. 2.125.26



Item no. 2.133.20



Item no. 2.545.24



Item no. 2.549.40

Item no.	Item description	EAN
Cortical screw Ø 2.0 mm; angle-stable; stainless steel		
2.114.06	Cortical screw with conical head thread; Ø 2.0 x 6 mm; fully threaded; self tapping; stainless steel	4 047075 129669
2.114.08	Cortical screw with conical head thread; Ø 2.0 x 8 mm; fully threaded; self tapping; stainless steel	4 047075 129676
2.114.10	Cortical screw with conical head thread; Ø 2.0 x 10 mm; fully threaded; self tapping; stainless steel	4 047075 129683
2.114.12	Cortical screw with conical head thread; Ø 2.0 x 12 mm; fully threaded; self tapping; stainless steel	4 047075 129690
2.114.14	Cortical screw with conical head thread; Ø 2.0 x 14 mm; fully threaded; self tapping; stainless steel	4 047075 129706
2.114.16	Cortical screw with conical head thread; Ø 2.0 x 16 mm; fully threaded; self tapping; stainless steel	4 047075 142170
2.114.18	Cortical screw with conical head thread; Ø 2.0 x 18 mm; fully threaded; self tapping; stainless steel	4 047075 142187
2.114.20	Cortical screw with conical head thread; Ø 2.0 x 20 mm; fully threaded; self tapping; stainless steel	4 047075 129713
2.114.22	Cortical screw with conical head thread; Ø 2.0 x 22 mm; fully threaded; self tapping; stainless steel	4 047075 142194
2.114.24	Cortical screw with conical head thread; Ø 2.0 x 24 mm; fully threaded; self tapping; stainless steel	4 047075 142200
2.114.26	Cortical screw with conical head thread; Ø 2.0 x 26 mm; fully threaded; self tapping; stainless steel	4 047075 142217
Cortical screw Ø 2.7 mm; angle-stable; stainless steel		
2.125.08	Cortical screw with conical head thread; Ø 2.7 x 8 mm; fully threaded; self tapping; head 5.0 mm; stainless steel	4 047075 129218
2.125.10	Cortical screw with conical head thread; Ø 2.7 x 10 mm; fully threaded; self tapping; head 5.0 mm; stainless steel	4 047075 124244
2.125.12	Cortical screw with conical head thread; Ø 2.7 x 12 mm; fully threaded; self tapping; head 5.0 mm; stainless steel	4 047075 124251
2.125.14	Cortical screw with conical head thread; Ø 2.7 x 14 mm; fully threaded; self tapping; head 5.0 mm; stainless steel	4 047075 124268
2.125.16	Cortical screw with conical head thread; Ø 2.7 x 16 mm; fully threaded; self tapping; head 5.0 mm; stainless steel	4 047075 124275

Cancellous screw

angle-stable; stainless steel



Item no. 2.147.20



Item no. 2.163.45

Item no.	Item description	EAN
Cancellous screw Ø 4.0 mm; angle-stable; stainless steel		
2.147.46	Cancellous screw with conical head thread; Ø 4.0 x 46 mm; fully threaded; self tapping; stainless steel	4 047075 060528
2.147.48	Cancellous screw with conical head thread; Ø 4.0 x 48 mm; fully threaded; self tapping; stainless steel	4 047075 060535
2.147.50	Cancellous screw with conical head thread; Ø 4.0 x 50 mm; fully threaded; self tapping; stainless steel	4 047075 060542
2.147.52	Cancellous screw with conical head thread; Ø 4.0 x 52 mm; fully threaded; self tapping; stainless steel	4 047075 060537
2.147.54	Cancellous screw with conical head thread; Ø 4.0 x 54 mm; fully threaded; self tapping; stainless steel	4 047075 060544
2.147.55	Cancellous screw with conical head thread; Ø 4.0 x 55 mm; fully threaded; self tapping; stainless steel	4 047075 114023
2.147.56	Cancellous screw with conical head thread; Ø 4.0 x 56 mm; fully threaded; self tapping; stainless steel	4 047075 060566
2.147.60	Cancellous screw with conical head thread; Ø 4.0 x 60 mm; fully threaded; self tapping; stainless steel	4 047075 110964
2.147.65	Cancellous screw with conical head thread; Ø 4.0 x 65 mm; fully threaded; self tapping; stainless steel	4 047075 110971
2.147.70	Cancellous screw with conical head thread; Ø 4.0 x 70 mm; fully threaded; self tapping; stainless steel	4 047075 110988
2.147.75	Cancellous screw with conical head thread; Ø 4.0 x 75 mm; fully threaded; self tapping; stainless steel	4 047075 110995
2.147.80	Cancellous screw with conical head thread; Ø 4.0 x 80 mm; fully threaded; self tapping; stainless steel	4 047075 111008
2.147.85	Cancellous screw with conical head thread; Ø 4.0 x 85 mm; fully threaded; self tapping; stainless steel	4 047075 111015
2.147.90	Cancellous screw with conical head thread; Ø 4.0 x 90 mm; fully threaded; self tapping; stainless steel	4 047075 111022
2.147.95	Cancellous screw with conical head thread; Ø 4.0 x 95 mm; fully threaded; self tapping; stainless steel	4 047075 111039

Cortical screw

angle-stable; stainless steel



Item no. 2.114.14



Item no. 2.125.26



















Item no. 2.133.20



Item no. 2.545.24



Item no. 2.549.40

Item no.	Item description	EAN
Cortical screw Ø 3.5 mm; angle-stable; stainless steel		
2.133.10	Cortical screw with conical head thread; Ø 3.5 x 10 mm; fully threaded; self tapping; stainless steel	
2.133.12	Cortical screw with conical head thread; Ø 3.5 x 12 mm; fully threaded; self tapping; stainless steel	
2.133.14	Cortical screw with conical head thread; Ø 3.5 x 14 mm; fully threaded; self tapping; stainless steel	
2.133.16	Cortical screw with conical head thread; Ø 3.5 x 16 mm; fully threaded; self tapping; stainless steel	
2.133.18	Cortical screw with conical head thread; Ø 3.5 x 18 mm; fully threaded; self tapping; stainless steel	
2.133.20	Cortical screw with conical head thread; Ø 3.5 x 20 mm; fully threaded; self tapping; stainless steel	
2.133.22	Cortical screw with conical head thread; Ø 3.5 x 22 mm; fully threaded; self tapping; stainless steel	
2.133.24	Cortical screw with conical head thread; Ø 3.5 x 24 mm; fully threaded; self tapping; stainless steel	
2.133.26	Cortical screw with conical head thread; Ø 3.5 x 26 mm; fully threaded; self tapping; stainless steel	
2.133.28	Cortical screw with conical head thread; Ø 3.5 x 28 mm; fully threaded; self tapping; stainless steel	
2.133.30	Cortical screw with conical head thread; Ø 3.5 x 30 mm; fully threaded; self tapping; stainless steel	
2.133.32	Cortical screw with conical head thread; Ø 3.5 x 32 mm; fully threaded; self tapping; stainless steel	
2.133.34	Cortical screw with conical head thread; Ø 3.5 x 34 mm; fully threaded; self tapping; stainless steel	
2.133.35	Cortical screw with conical head thread; Ø 3.5 x 35 mm; fully threaded; self tapping; stainless steel	
2.133.36	Cortical screw with conical head thread; Ø 3.5 x 36 mm; fully threaded; self tapping; stainless steel	
2.133.38	Cortical screw with conical head thread; Ø 3.5 x 38 mm; fully threaded; self tapping; stainless steel	
2.133.40	Cortical screw with conical head thread; Ø 3.5 x 40 mm; fully threaded; self tapping; stainless steel	

Cortical screw

angle-stable; stainless steel



Item no. 2.114.14



Item no. 2.125.26



Item no. 2.133.20



Item no. 2.545.24



Item no. 2.549.40

Item no.	Item description	EAN
Cortical screw Ø 3.5 mm; angle-stable; stainless steel		
2.133.42	Cortical screw with conical head thread; Ø 3.5 x 42 mm; fully threaded; self tapping; stainless steel	4 047075 069446
2.133.44	Cortical screw with conical head thread; Ø 3.5 x 44 mm; fully threaded; self tapping; stainless steel	4 047075 069347
2.133.45	Cortical screw with conical head thread; Ø 3.5 x 45 mm; fully threaded; self tapping; stainless steel	4 047075 113996
2.133.46	Cortical screw with conical head thread; Ø 3.5 x 46 mm; fully threaded; self tapping; stainless steel	4 047075 069354
2.133.48	Cortical screw with conical head thread; Ø 3.5 x 48 mm; fully threaded; self tapping; stainless steel	4 047075 069255
2.133.50	Cortical screw with conical head thread; Ø 3.5 x 50 mm; fully threaded; self tapping; stainless steel	4 047075 069262
2.133.55	Cortical screw with conical head thread; Ø 3.5 x 55 mm; fully threaded; self tapping; stainless steel	4 047075 113972
2.133.60	Cortical screw with conical head thread; Ø 3.5 x 60 mm; fully threaded; self tapping; stainless steel	4 047075 069378
2.133.65	Cortical screw with conical head thread; Ø 3.5 x 65 mm; fully threaded; self tapping; stainless steel	4 047075 069293
Cortical screw Ø 4.5 mm; angle-stable; stainless steel		
2.545.10	Cortical screw with conical head thread; Ø 4.5 x 10 mm; fully threaded; self tapping; stainless steel	4 047075 080748
2.545.12	Cortical screw with conical head thread; Ø 4.5 x 12 mm; fully threaded; self tapping; stainless steel	4 047075 080632
2.545.14	Cortical screw with conical head thread; Ø 4.5 x 14 mm; fully threaded; self tapping; stainless steel	4 047075 080649
2.545.16	Cortical screw with conical head thread; Ø 4.5 x 16 mm; fully threaded; self tapping; stainless steel	4 047075 080779
2.545.18	Cortical screw with conical head thread; Ø 4.5 x 18 mm; fully threaded; self tapping; stainless steel	4 047075 080878
2.545.20	Cortical screw with conical head thread; Ø 4.5 x 20 mm; fully threaded; self tapping; stainless steel	4 047075 080885
2.545.22	Cortical screw with conical head thread; Ø 4.5 x 22 mm; fully threaded; self tapping; stainless steel	4 047075 080755

Cortical screw

angle-stable; stainless steel



Item no. 2.114.14



Item no. 2.125.26



Item no. 2.133.20



Item no. 2.545.24



Item no. 2.549.40

Item no.	Item description	EAN
Cortical screw Ø 4.5 mm; angle-stable; stainless steel		
2.545.24	Cortical screw with conical head thread; Ø 4.5 x 24 mm; fully threaded; self tapping; stainless steel	4 047075 080762
2.545.26	Cortical screw with conical head thread; Ø 4.5 x 26 mm; fully threaded; self tapping; stainless steel	4 047075 080915
2.545.28	Cortical screw with conical head thread; Ø 4.5 x 28 mm; fully threaded; self tapping; stainless steel	4 047075 080922
2.545.30	Cortical screw with conical head thread; Ø 4.5 x 30 mm; fully threaded; self tapping; stainless steel	4 047075 080793
2.545.32	Cortical screw with conical head thread; Ø 4.5 x 32 mm; fully threaded; self tapping; stainless steel	4 047075 080809
2.545.34	Cortical screw with conical head thread; Ø 4.5 x 34 mm; fully threaded; self tapping; stainless steel	4 047075 080892
2.545.36	Cortical screw with conical head thread; Ø 4.5 x 36 mm; fully threaded; self tapping; stainless steel	4 047075 080908
2.545.38	Cortical screw with conical head thread; Ø 4.5 x 38 mm; fully threaded; self tapping; stainless steel	4 047075 081028
2.545.40	Cortical screw with conical head thread; Ø 4.5 x 40 mm; fully threaded; self tapping; stainless steel	4 047075 080939
2.545.42	Cortical screw with conical head thread; Ø 4.5 x 42 mm; fully threaded; self tapping; stainless steel	4 047075 080946
2.545.44	Cortical screw with conical head thread; Ø 4.5 x 44 mm; fully threaded; self tapping; stainless steel	4 047075 080816
2.545.45	Cortical screw with conical head thread; Ø 4.5 x 45 mm; fully threaded; self tapping; stainless steel	4 047075 080823
2.545.46	Cortical screw with conical head thread; Ø 4.5 x 46 mm; fully threaded; self tapping; stainless steel	4 047075 080977
2.545.48	Cortical screw with conical head thread; Ø 4.5 x 48 mm; fully threaded; self tapping; stainless steel	4 047075 081035
2.545.50	Cortical screw with conical head thread; Ø 4.5 x 50 mm; fully threaded; self tapping; stainless steel	4 047075 081042
2.545.52	Cortical screw with conical head thread; Ø 4.5 x 52 mm; fully threaded; self tapping; stainless steel	4 047075 080953
2.545.54	Cortical screw with conical head thread; Ø 4.5 x 54 mm; fully threaded; self tapping; stainless steel	4 047075 080960

Cortical screw

angle-stable; stainless steel



Item no. 2.114.14



Item no. 2.125.26



Item no. 2.133.20



Item no. 2.545.24



Item no. 2.549.40

Item no.	Item description	EAN
Cortical screw Ø 4.5 mm; angle-stable; stainless steel		
2.545.55	Cortical screw with conical head thread; Ø 4.5 x 55 mm; fully threaded; self tapping; stainless steel	4 047075 081073
2.545.56	Cortical screw with conical head thread; Ø 4.5 x 56 mm; fully threaded; self tapping; stainless steel	4 047075 081080
2.545.58	Cortical screw with conical head thread; Ø 4.5 x 58 mm; fully threaded; self tapping; stainless steel	4 047075 080984
2.545.60	Cortical screw with conical head thread; Ø 4.5 x 60 mm; fully threaded; self tapping; stainless steel	4 047075 080991
2.545.62	Cortical screw with conical head thread; Ø 4.5 x 62 mm; fully threaded; self tapping; stainless steel	4 047075 081059
2.545.64	Cortical screw with conical head thread; Ø 4.5 x 64 mm; fully threaded; self tapping; stainless steel	4 047075 081066
2.545.65	Cortical screw with conical head thread; Ø 4.5 x 65 mm; fully threaded; self tapping; stainless steel	4 047075 033065
2.545.66	Cortical screw with conical head thread; Ø 4.5 x 66 mm; fully threaded; self tapping; stainless steel	4 047075 081189
2.545.68	Cortical screw with conical head thread; Ø 4.5 x 68 mm; fully threaded; self tapping; stainless steel	4 047075 081097
2.545.70	Cortical screw with conical head thread; Ø 4.5 x 70 mm; fully threaded; self tapping; stainless steel	4 047075 081103
2.545.75	Cortical screw with conical head thread; Ø 4.5 x 75 mm; fully threaded; self tapping; stainless steel	4 047075 069972
2.545.80	Cortical screw with conical head thread; Ø 4.5 x 80 mm; fully threaded; self tapping; stainless steel	4 047075 094424
2.545.85	Cortical screw with conical head thread; Ø 4.5 x 85 mm; fully threaded; self tapping; stainless steel	4 047075 094431

Cortical screw

angle-stable; stainless steel



Item no. 2.114.14



Item no. 2.125.26















Item no. 2.133.20



Item no. 2.545.24



Item no. 2.549.40

Item no.	Item description	EAN
Cortical screw Ø 5.5 mm; angle-stable; stainless steel		
2.549.20	Cortical screw with conical head thread; Ø 5.5 x 20 mm; fully threaded; self tapping; stainless steel	 4 ⁰ 047075 ¹ 146970
2.549.35	Cortical screw with conical head thread; Ø 5.5 x 35 mm; fully threaded; self tapping; stainless steel	 4 ⁰ 047075 ¹ 146987
2.549.40	Cortical screw with conical head thread; Ø 5.5 x 40 mm; fully threaded; self tapping; stainless steel	 4 ⁰ 047075 ¹ 139569
2.549.45	Cortical screw with conical head thread; Ø 5.5 x 45 mm; fully threaded; self tapping; stainless steel	 4 ⁰ 047075 ¹ 139576
2.549.50	Cortical screw with conical head thread; Ø 5.5 x 50 mm; fully threaded; self tapping; stainless steel	 4 ⁰ 047075 ¹ 139583
2.549.55	Cortical screw with conical head thread; Ø 5.5 x 55 mm; fully threaded; self tapping; stainless steel	 4 ⁰ 047075 ¹ 139590
2.549.60	Cortical screw with conical head thread; Ø 5.5 x 60 mm; fully threaded; self tapping; stainless steel	 4 ⁰ 047075 ¹ 139606
2.549.65	Cortical screw with conical head thread; Ø 5.5 x 65 mm; fully threaded; self tapping; stainless steel	 4 ⁰ 047075 ¹ 139613
2.549.70	Cortical screw with conical head thread; Ø 5.5 x 70 mm; fully threaded; self tapping; stainless steel	 4 ⁰ 047075 ¹ 139620
2.549.75	Cortical screw with conical head thread; Ø 5.5 x 75 mm; fully threaded; self tapping; stainless steel	 4 ⁰ 047075 ¹ 139637
2.549.80	Cortical screw with conical head thread; Ø 5.5 x 80 mm; fully threaded; self tapping; stainless steel	 4 ⁰ 047075 ¹ 139644
2.549.85	Cortical screw with conical head thread; Ø 5.5 x 85 mm; fully threaded; self tapping; stainless steel	 4 ⁰ 047075 ¹ 139651
2.549.90	Cortical screw with conical head thread; Ø 5.5 x 90 mm; fully threaded; self tapping; stainless steel	 4 ⁰ 047075 ¹ 139668

Cancellous screw

angle-stable; titanium



Item no. 3.147.40



Item no. 3.163.45

Item no.	Item description	EAN
Cancellous screw Ø 4.0 mm; angle-stable; titanium		
3.147.10	Cancellous screw with conical head thread; Ø 4.0 x 10 mm; fully threaded; self tapping; titanium	4 047075 091225
3.147.12	Cancellous screw with conical head thread; Ø 4.0 x 12 mm; fully threaded; self tapping; titanium	4 047075 091355
3.147.14	Cancellous screw with conical head thread; Ø 4.0 x 14 mm; fully threaded; self tapping; titanium	4 047075 091249
3.147.16	Cancellous screw with conical head thread; Ø 4.0 x 16 mm; fully threaded; self tapping; titanium	4 047075 091256
3.147.18	Cancellous screw with conical head thread; Ø 4.0 x 18 mm; fully threaded; self tapping; titanium	4 047075 091263
3.147.20	Cancellous screw with conical head thread; Ø 4.0 x 20 mm; fully threaded; self tapping; titanium	4 047075 091140
3.147.22	Cancellous screw with conical head thread; Ø 4.0 x 22 mm; fully threaded; self tapping; titanium	4 047075 091508
3.147.24	Cancellous screw with conical head thread; Ø 4.0 x 24 mm; fully threaded; self tapping; titanium	4 047075 091362
3.147.26	Cancellous screw with conical head thread; Ø 4.0 x 26 mm; fully threaded; self tapping; titanium	4 047075 091379
3.147.28	Cancellous screw with conical head thread; Ø 4.0 x 28 mm; fully threaded; self tapping; titanium	4 047075 091386
3.147.30	Cancellous screw with conical head thread; Ø 4.0 x 30 mm; fully threaded; self tapping; titanium	4 047075 091270
3.147.32	Cancellous screw with conical head thread; Ø 4.0 x 32 mm; fully threaded; self tapping; titanium	4 047075 091287
3.147.34	Cancellous screw with conical head thread; Ø 4.0 x 34 mm; fully threaded; self tapping; titanium	4 047075 091416
3.147.35	Cancellous screw with conical head thread; Ø 4.0 x 35 mm; fully threaded; self tapping; titanium	4 047075 091423
3.147.36	Cancellous screw with conical head thread; Ø 4.0 x 36 mm; fully threaded; self tapping; titanium	4 047075 091294
3.147.38	Cancellous screw with conical head thread; Ø 4.0 x 38 mm; fully threaded; self tapping; titanium	4 047075 091300
3.147.40	Cancellous screw with conical head thread; Ø 4.0 x 40 mm; fully threaded; self tapping; titanium	4 047075 091317

Cancellous screw

angle-stable; titanium



Item no. 3.147.40



Item no. 3.163.45

Item no.	Item description	EAN
Cancellous screw Ø 4.0 mm; angle-stable; titanium		
3.147.42	Cancellous screw with conical head thread; Ø 4x42 mm; fully threaded; self tapping; titanium	4 047075 091539
3.147.44	Cancellous screw with conical head thread; Ø 4x44 mm; fully threaded; self tapping; titanium	4 047075 091546
3.147.45	Cancellous screw with conical head thread; Ø 4x45 mm; fully threaded; self tapping; titanium	4 047075 091553
3.147.46	Cancellous screw with conical head thread; Ø 4x46 mm; fully threaded; self tapping; titanium	4 047075 091393
3.147.48	Cancellous screw with conical head thread; Ø 4x48 mm; fully threaded; self tapping; titanium	4 047075 091409
3.147.50	Cancellous screw with conical head thread; Ø 4x50 mm; fully threaded; self tapping; titanium	4 047075 091577
3.147.52	Cancellous screw with conical head thread; Ø 4x52 mm; fully threaded; self tapping; titanium	4 047075 091430
3.147.54	Cancellous screw with conical head thread; Ø 4x54 mm; fully threaded; self tapping; titanium	4 047075 091447
3.147.55	Cancellous screw with conical head thread; Ø 4x55 mm; fully threaded; self tapping; titanium	4 047075 091454
3.147.56	Cancellous screw with conical head thread; Ø 4x56 mm; fully threaded; self tapping; titanium	4 047075 091461
3.147.58	Cancellous screw with conical head thread; Ø 4x58 mm; fully threaded; self tapping; titanium	4 047075 091478
3.147.60	Cancellous screw with conical head thread; Ø 4x60 mm; fully threaded; self tapping; titanium	4 047075 091485
3.147.65	Cancellous screw with conical head thread; Ø 4x65 mm; fully threaded; self tapping; titanium	4 047075 116041
3.147.70	Cancellous screw with conical head thread; Ø 4x70 mm; fully threaded; self tapping; titanium	4 047075 091348
3.147.75	Cancellous screw with conical head thread; Ø 4x75 mm; fully threaded; self tapping; titanium	4 047075 116058
3.147.80	Cancellous screw with conical head thread; Ø 4x80 mm; fully threaded; self tapping; titanium	4 047075 116065

Cancellous screw

















angle-stable; titanium



Item no. 3.147.40



Item no. 3.163.45

Item no.	Item description	EAN
Cancellous screw; Ø 6.0 mm; angle-stable; titanium		
3.163.24	Cancellous screw with conical head thread; Ø 6.0 x 24 mm; fully threaded; self tapping; titanium	 4 047075 093472
3.163.26	Cancellous screw with conical head thread; Ø 6.0 x 26 mm; fully threaded; self tapping; titanium	 4 047075 093359
3.163.28	Cancellous screw with conical head thread; Ø 6.0 x 28 mm; fully threaded; self tapping; titanium	 4 047075 093366
3.163.30	Cancellous screw with conical head thread; Ø 6.0 x 30 mm; fully threaded; self tapping; titanium	 4 047075 093496
3.163.32	Cancellous screw with conical head thread; Ø 6.0 x 32 mm; fully threaded; self tapping; titanium	 4 047075 093373
3.163.34	Cancellous screw with conical head thread; Ø 6.0 x 34 mm; fully threaded; self tapping; titanium	 4 047075 093588
3.163.35	Cancellous screw with conical head thread; Ø 6.0 x 35 mm; fully threaded; self tapping; titanium	 4 047075 093595
3.163.36	Cancellous screw with conical head thread; Ø 6.0 x 36 mm; fully threaded; self tapping; titanium	 4 047075 093601
3.163.38	Cancellous screw with conical head thread; Ø 6.0 x 38 mm; fully threaded; self tapping; titanium	 4 047075 093489
3.163.40	Cancellous screw with conical head thread; Ø 6.0 x 40 mm; fully threaded; self tapping; titanium	 4 047075 093625
3.163.42	Cancellous screw with conical head thread; Ø 6.0 x 42 mm; fully threaded; self tapping; titanium	 4 047075 093502
3.163.44	Cancellous screw with conical head thread; Ø 6.0 x 44 mm; fully threaded; self tapping; titanium	 4 047075 093519
3.163.45	Cancellous screw with conical head thread; Ø 6.0 x 45 mm; fully threaded; self tapping; titanium	 4 047075 093526
3.163.46	Cancellous screw with conical head thread; Ø 6.0 x 46 mm; fully threaded; self tapping; titanium	 4 047075 093533
3.163.48	Cancellous screw with conical head thread; Ø 6.0 x 48 mm; fully threaded; self tapping; titanium	 4 047075 093403
3.163.50	Cancellous screw with conical head thread; Ø 6.0 x 50 mm; fully threaded; self tapping; titanium	 4 047075 093731
3.163.52	Cancellous screw with conical head thread; Ø 6.0 x 52 mm; fully threaded; self tapping; titanium	 4 047075 093632

Cancellous screw

angle-stable; titanium



Item no. 3.147.40



Item no. 3.163.45

Item no.	Item description	EAN
Cancellous screw; Ø 6.0 mm; angle-stable; titanium		
3.163.54	Cancellous screw with conical head thread; Ø 6.0 x 54 mm; fully threaded; self tapping; titanium	4 047075 093649
3.163.55	Cancellous screw with conical head thread; Ø 6.0 x 55 mm; fully threaded; self tapping; titanium	4 047075 093656
3.163.56	Cancellous screw with conical head thread; Ø 6.0 x 56 mm; fully threaded; self tapping; titanium	4 047075 093663
3.163.58	Cancellous screw with conical head thread; Ø 6.0 x 58 mm; fully threaded; self tapping; titanium	4 047075 093540
3.163.60	Cancellous screw with conical head thread; Ø 6.0 x 60 mm; fully threaded; self tapping; titanium	4 047075 093687
3.163.62	Cancellous screw with conical head thread; Ø 6.0 x 62 mm; fully threaded; self tapping; titanium	4 047075 119615
3.163.64	Cancellous screw with conical head thread; Ø 6.0 x 64 mm; fully threaded; self tapping; titanium	4 047075 119622
3.163.65	Cancellous screw with conical head thread; Ø 6.0 x 65 mm; fully threaded; self tapping; titanium	4 047075 093557
3.163.66	Cancellous screw with conical head thread; Ø 6.0 x 66 mm; fully threaded; self tapping; titanium	4 047075 119639
3.163.68	Cancellous screw with conical head thread; Ø 6.0 x 68 mm; fully threaded; self tapping; titanium	4 047075 119646
3.163.70	Cancellous screw with conical head thread; Ø 6.0 x 70 mm; fully threaded; self tapping; titanium	4 047075 093564
3.163.72	Cancellous screw with conical head thread; Ø 6.0 x 72 mm; fully threaded; self tapping; titanium	4 047075 126361
3.163.74	Cancellous screw with conical head thread; Ø 6.0 x 74 mm; fully threaded; self tapping; titanium	4 047075 119653
3.163.75	Cancellous screw with conical head thread; Ø 6.0 x 75 mm; fully threaded; self tapping; titanium	4 047075 059515
3.163.76	Cancellous screw with conical head thread; Ø 6.0 x 76 mm; fully threaded; self tapping; titanium	4 047075 128808
3.163.78	Cancellous screw with conical head thread; Ø 6.0 x 78 mm; fully threaded; self tapping; titanium	4 047075 128716
3.163.80	Cancellous screw with conical head thread; Ø 6.0 x 80 mm; fully threaded; self tapping; titanium	4 047075 093571

Cancellous screw

angle-stable; titanium



Item no. 3.147.40



Item no. 3.163.45

Item no.	Item description	EAN
Cancellous screw; Ø 6.0 mm; angle-stable; titanium		
3.163.82	Cancellous screw with conical head thread; Ø 6.0 x 82 mm; fully threaded; self tapping; titanium	4 ⁰ 047075 ⁰ 128815
3.163.84	Cancellous screw with conical head thread; Ø 6.0 x 84 mm; fully threaded; self tapping; titanium	4 ⁰ 047075 ⁰ 128822
3.163.85	Cancellous screw with conical head thread; Ø 6.0 x 85 mm; fully threaded; self tapping; titanium	4 ⁰ 047075 ⁰ 059522
3.163.86	Cancellous screw with conical head thread; Ø 6.0 x 86 mm; fully threaded; self tapping; titanium	4 ⁰ 047075 ⁰ 128839
3.163.90	Cancellous screw with conical head thread; Ø 6.0 x 90 mm; fully threaded; self tapping; titanium	4 ⁰ 047075 ⁰ 059300

Cancellous screw

angle-stable; stainless steel



Item no. 2.147.20



Item no. 2.163.45

Item no.	Item description	EAN
Cancellous screw Ø 4.0 mm; angle-stable; stainless steel		
2.147.16	Cancellous screw with conical head thread; Ø 4.0 x 16 mm; fully threaded; self tapping; stainless steel	4 047075 130023
2.147.18	Cancellous screw with conical head thread; Ø 4.0 x 18 mm; fully threaded; self tapping; stainless steel	4 047075 130030
2.147.20	Cancellous screw with conical head thread; Ø 4.0 x 20 mm; fully threaded; self tapping; stainless steel	4 047075 130047
2.147.22	Cancellous screw with conical head thread; Ø 4.0 x 22 mm; fully threaded; self tapping; stainless steel	4 047075 130054
2.147.24	Cancellous screw with conical head thread; Ø 4.0 x 24 mm; fully threaded; self tapping; stainless steel	4 047075 120581
2.147.26	Cancellous screw with conical head thread; Ø 4.0 x 26 mm; fully threaded; self tapping; stainless steel	4 047075 120598
2.147.28	Cancellous screw with conical head thread; Ø 4.0 x 28 mm; fully threaded; self tapping; stainless steel	4 047075 120604
2.147.30	Cancellous screw with conical head thread; Ø 4.0 x 30 mm; fully threaded; self tapping; stainless steel	4 047075 120611
2.147.32	Cancellous screw with conical head thread; Ø 4.0 x 32 mm; fully threaded; self tapping; stainless steel	4 047075 120628
2.147.34	Cancellous screw with conical head thread; Ø 4.0 x 34 mm; fully threaded; self tapping; stainless steel	4 047075 060634
2.147.35	Cancellous screw with conical head thread; Ø 4.0 x 35 mm; fully threaded; self tapping; stainless steel	4 047075 126033
2.147.36	Cancellous screw with conical head thread; Ø 4.0 x 36 mm; fully threaded; self tapping; stainless steel	4 047075 060450
2.147.38	Cancellous screw with conical head thread; Ø 4.0 x 38 mm; fully threaded; self tapping; stainless steel	4 047075 060467
2.147.40	Cancellous screw with conical head thread; Ø 4.0 x 40 mm; fully threaded; self tapping; stainless steel	4 047075 060658
2.147.42	Cancellous screw with conical head thread; Ø 4.0 x 42 mm; fully threaded; self tapping; stainless steel	4 047075 060665
2.147.44	Cancellous screw with conical head thread; Ø 4.0 x 44 mm; fully threaded; self tapping; stainless steel	4 047075 060511
2.147.45	Cancellous screw with conical head thread; Ø 4.0 x 45 mm; fully threaded; self tapping; stainless steel	4 047075 114016

Cancellous screw

angle-stable; stainless steel



Item no. 2.147.20



Item no. 2.163.45

Item no.	Item description	EAN
Cancellous screw Ø 4.0 mm; angle-stable; stainless steel		
2.147.46	Cancellous screw with conical head thread; Ø 4.0 x 46 mm; fully threaded; self tapping; stainless steel	4 047075 060528
2.147.48	Cancellous screw with conical head thread; Ø 4.0 x 48 mm; fully threaded; self tapping; stainless steel	4 047075 060535
2.147.50	Cancellous screw with conical head thread; Ø 4.0 x 50 mm; fully threaded; self tapping; stainless steel	4 047075 060542
2.147.52	Cancellous screw with conical head thread; Ø 4.0 x 52 mm; fully threaded; self tapping; stainless steel	4 047075 060537
2.147.54	Cancellous screw with conical head thread; Ø 4.0 x 54 mm; fully threaded; self tapping; stainless steel	4 047075 060344
2.147.55	Cancellous screw with conical head thread; Ø 4.0 x 55 mm; fully threaded; self tapping; stainless steel	4 047075 114023
2.147.56	Cancellous screw with conical head thread; Ø 4.0 x 56 mm; fully threaded; self tapping; stainless steel	4 047075 060566
2.147.60	Cancellous screw with conical head thread; Ø 4.0 x 60 mm; fully threaded; self tapping; stainless steel	4 047075 110964
2.147.65	Cancellous screw with conical head thread; Ø 4.0 x 65 mm; fully threaded; self tapping; stainless steel	4 047075 110971
2.147.70	Cancellous screw with conical head thread; Ø 4.0 x 70 mm; fully threaded; self tapping; stainless steel	4 047075 110988
2.147.75	Cancellous screw with conical head thread; Ø 4.0 x 75 mm; fully threaded; self tapping; stainless steel	4 047075 110995
2.147.80	Cancellous screw with conical head thread; Ø 4.0 x 80 mm; fully threaded; self tapping; stainless steel	4 047075 111008
2.147.85	Cancellous screw with conical head thread; Ø 4.0 x 85 mm; fully threaded; self tapping; stainless steel	4 047075 111015
2.147.90	Cancellous screw with conical head thread; Ø 4.0 x 90 mm; fully threaded; self tapping; stainless steel	4 047075 111022
2.147.95	Cancellous screw with conical head thread; Ø 4.0 x 95 mm; fully threaded; self tapping; stainless steel	4 047075 111039

Cancellous screw

















angle-stable; titanium



Item no. 3.147.40



Item no. 3.163.45

Item no.	Item description	EAN
Cancellous screw; Ø 6.0 mm; angle-stable; titanium		
3.163.24	Cancellous screw with conical head thread; Ø 6.0 x 24 mm; fully threaded; self tapping; titanium	 4 047075 093472
3.163.26	Cancellous screw with conical head thread; Ø 6.0 x 26 mm; fully threaded; self tapping; titanium	 4 047075 093359
3.163.28	Cancellous screw with conical head thread; Ø 6.0 x 28 mm; fully threaded; self tapping; titanium	 4 047075 093366
3.163.30	Cancellous screw with conical head thread; Ø 6.0 x 30 mm; fully threaded; self tapping; titanium	 4 047075 093496
3.163.32	Cancellous screw with conical head thread; Ø 6.0 x 32 mm; fully threaded; self tapping; titanium	 4 047075 093373
3.163.34	Cancellous screw with conical head thread; Ø 6.0 x 34 mm; fully threaded; self tapping; titanium	 4 047075 093588
3.163.35	Cancellous screw with conical head thread; Ø 6.0 x 35 mm; fully threaded; self tapping; titanium	 4 047075 093595
3.163.36	Cancellous screw with conical head thread; Ø 6.0 x 36 mm; fully threaded; self tapping; titanium	 4 047075 093601
3.163.38	Cancellous screw with conical head thread; Ø 6.0 x 38 mm; fully threaded; self tapping; titanium	 4 047075 093489
3.163.40	Cancellous screw with conical head thread; Ø 6.0 x 40 mm; fully threaded; self tapping; titanium	 4 047075 093625
3.163.42	Cancellous screw with conical head thread; Ø 6.0 x 42 mm; fully threaded; self tapping; titanium	 4 047075 093502
3.163.44	Cancellous screw with conical head thread; Ø 6.0 x 44 mm; fully threaded; self tapping; titanium	 4 047075 093519
3.163.45	Cancellous screw with conical head thread; Ø 6.0 x 45 mm; fully threaded; self tapping; titanium	 4 047075 093526
3.163.46	Cancellous screw with conical head thread; Ø 6.0 x 46 mm; fully threaded; self tapping; titanium	 4 047075 093533
3.163.48	Cancellous screw with conical head thread; Ø 6.0 x 48 mm; fully threaded; self tapping; titanium	 4 047075 093403
3.163.50	Cancellous screw with conical head thread; Ø 6.0 x 50 mm; fully threaded; self tapping; titanium	 4 047075 093731
3.163.52	Cancellous screw with conical head thread; Ø 6.0 x 52 mm; fully threaded; self tapping; titanium	 4 047075 093632

Cancellous screw

angle-stable; titanium



Item no. 3.147.40



Item no. 3.163.45

Item no.	Item description	EAN
Cancellous screw; Ø 6.0 mm; angle-stable; titanium		
3.163.54	Cancellous screw with conical head thread; Ø 6.0 x 54 mm; fully threaded; self tapping; titanium	4 047075 093649
3.163.55	Cancellous screw with conical head thread; Ø 6.0 x 55 mm; fully threaded; self tapping; titanium	4 047075 093656
3.163.56	Cancellous screw with conical head thread; Ø 6.0 x 56 mm; fully threaded; self tapping; titanium	4 047075 093663
3.163.58	Cancellous screw with conical head thread; Ø 6.0 x 58 mm; fully threaded; self tapping; titanium	4 047075 093540
3.163.60	Cancellous screw with conical head thread; Ø 6.0 x 60 mm; fully threaded; self tapping; titanium	4 047075 093687
3.163.62	Cancellous screw with conical head thread; Ø 6.0 x 62 mm; fully threaded; self tapping; titanium	4 047075 119615
3.163.64	Cancellous screw with conical head thread; Ø 6.0 x 64 mm; fully threaded; self tapping; titanium	4 047075 119622
3.163.65	Cancellous screw with conical head thread; Ø 6.0 x 65 mm; fully threaded; self tapping; titanium	4 047075 093557
3.163.66	Cancellous screw with conical head thread; Ø 6.0 x 66 mm; fully threaded; self tapping; titanium	4 047075 119639
3.163.68	Cancellous screw with conical head thread; Ø 6.0 x 68 mm; fully threaded; self tapping; titanium	4 047075 119646
3.163.70	Cancellous screw with conical head thread; Ø 6.0 x 70 mm; fully threaded; self tapping; titanium	4 047075 093564
3.163.72	Cancellous screw with conical head thread; Ø 6.0 x 72 mm; fully threaded; self tapping; titanium	4 047075 126361
3.163.74	Cancellous screw with conical head thread; Ø 6.0 x 74 mm; fully threaded; self tapping; titanium	4 047075 119653
3.163.75	Cancellous screw with conical head thread; Ø 6.0 x 75 mm; fully threaded; self tapping; titanium	4 047075 059515
3.163.76	Cancellous screw with conical head thread; Ø 6.0 x 76 mm; fully threaded; self tapping; titanium	4 047075 128808
3.163.78	Cancellous screw with conical head thread; Ø 6.0 x 78 mm; fully threaded; self tapping; titanium	4 047075 128716
3.163.80	Cancellous screw with conical head thread; Ø 6.0 x 80 mm; fully threaded; self tapping; titanium	4 047075 093571

Cancellous screw

angle-stable; titanium



Item no. 3.147.40



Item no. 3.163.45

Item no.	Item description	EAN
Cancellous screw; Ø 6.0 mm; angle-stable; titanium		
3.163.82	Cancellous screw with conical head thread; Ø 6.0 x 82 mm; fully threaded; self tapping; titanium	4 ⁰ 047075 ⁰ 128815
3.163.84	Cancellous screw with conical head thread; Ø 6.0 x 84 mm; fully threaded; self tapping; titanium	4 ⁰ 047075 ⁰ 128822
3.163.85	Cancellous screw with conical head thread; Ø 6.0 x 85 mm; fully threaded; self tapping; titanium	4 ⁰ 047075 ⁰ 059522
3.163.86	Cancellous screw with conical head thread; Ø 6.0 x 86 mm; fully threaded; self tapping; titanium	4 ⁰ 047075 ⁰ 128839
3.163.90	Cancellous screw with conical head thread; Ø 6.0 x 90 mm; fully threaded; self tapping; titanium	4 ⁰ 047075 ⁰ 059300

Set Screw container for Large fragment

titanium; Set no. 19.168.40



Item no. 3.152.30



Item no. 3.170.70



Item no. 3.180.70



Item no. 3.190.70



Set no. 19.168.40 *  internal hexagon

Item no.	Item description	Quant.
Implants – screws		
Cortical screw Ø 4.5 mm; fully threaded; self tapping; titanium		
3.152.14	length 14 mm	3
3.152.16	length 16 mm	3
3.152.18	length 18 mm	3
3.152.20	length 20 mm	3
3.152.22	length 22 mm	3
3.152.24	length 24 mm	3
3.152.26	length 26 mm	3
3.152.28	length 28 mm	3
3.152.30	length 30 mm	3
3.152.32	length 32 mm	3
3.152.34	length 34 mm	3
3.152.36	length 36 mm	3
3.152.38	length 38 mm	3
3.152.40	length 40 mm	3
3.152.42	length 42 mm	3
3.152.44	length 44 mm	3
3.152.46	length 46 mm	3
3.152.48	length 48 mm	3
3.152.50	length 50 mm	2
3.152.52	length 52 mm	2
3.152.54	length 54 mm	2
3.152.56	length 56 mm	2
3.152.58	length 58 mm	2
3.152.60	length 60 mm	2

Item no.	Item description	Quant.
Implants – screws		
Cortical screw Ø 4.5 mm; fully threaded; self tapping; titanium		
3.152.64	length 64 mm	2
3.152.68	length 68 mm	2
3.152.70	length 70 mm	2
3.152.72	length 72 mm	2

Item no.	Item description	Quant.
Cancellous screw Ø 6.5 mm; thread 16; titanium		
3.170.30	length 30 mm	3
3.170.35	length 35 mm	3
3.170.40	length 40 mm	3
3.170.45	length 45 mm	3
3.170.50	length 50 mm	3
3.170.55	length 55 mm	3
3.170.60	length 60 mm	3
3.170.65	length 65 mm	3
3.170.70	length 70 mm	3
3.170.75	length 75 mm	3
3.170.80	length 80 mm	3
3.170.85	length 85 mm	3
3.170.90	length 90 mm	3
3.170.95	length 95 mm	3
3.170.100	length 100 mm	3
3.170.105	length 105 mm	3
3.170.110	length 110 mm	3

Set Screw container for Large fragment

titanium; Set no. 19.168.40

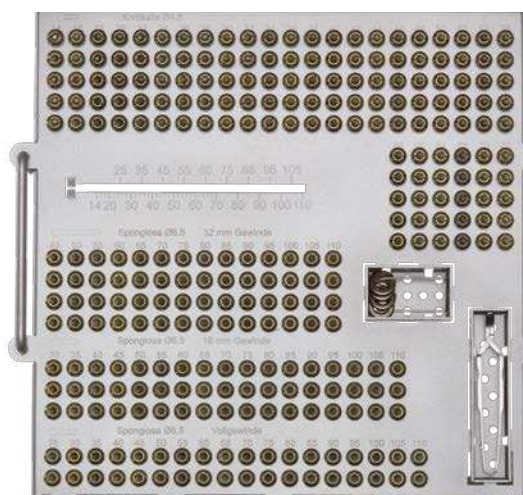

Set no. 19.168.40 *  internal hexagon

Item no.	Item description	Quant.
Implants – screws		
Cancellous screw Ø 6.5 mm; thread 32; titanium		
3.180.45	length 45 mm	3
3.180.50	length 50 mm	3
3.180.55	length 55 mm	3
3.180.60	length 60 mm	3
3.180.65	length 65 mm	3
3.180.70	length 70 mm	3
3.180.75	length 75 mm	3
3.180.80	length 80 mm	3
3.180.85	length 85 mm	3
3.180.90	length 90 mm	3
3.180.95	length 95 mm	3
3.180.100	length 100 mm	3
3.180.105	length 105 mm	3
3.180.110	length 110 mm	3

Instruments		
2.954.01	screw forceps; self holding	1
20.502.00	holding clamp; big	1

Implants - washers		
3.200.03	washer; outside Ø 13 mm / inside Ø 6.7 mm; titanium	3

* Example illustration can show different number of screws.

Item no.	Item description	Quant.
Implants – screws		
Cancellous screw Ø 6.5 mm; fully threaded; titanium		
3.190.25	length 25 mm	2
3.190.30	length 30 mm	2
3.190.35	length 35 mm	2
3.190.40	length 40 mm	2
3.190.45	length 45 mm	2
3.190.50	length 50 mm	2
3.190.55	length 55 mm	2
3.190.60	length 60 mm	2
3.190.65	length 65 mm	2
3.190.70	length 70 mm	2
3.190.75	length 75 mm	2
3.190.80	length 80 mm	2
3.190.85	length 85 mm	2
3.190.90	length 90 mm	2
3.190.95	length 95 mm	2
3.190.100	length 100 mm	2
3.190.105	length 105 mm	2
3.190.110	length 110 mm	2

Container		
19.168.00	screw container for large fragment; empty	1

Set Screw container for Large fragment

stainless steel; Set no. 19.168.20



Item no. 2.152.30



Item no. 2.170.50



Item no. 2.180.50



Item no. 2.190.50

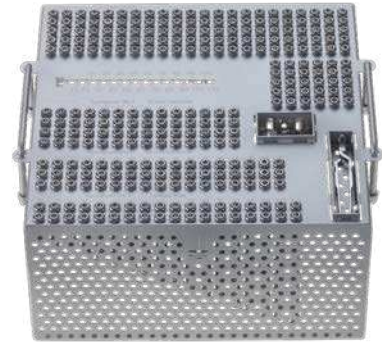

Set no. 19.168.20 *  internal hexagon

Item no.	Item description	Quant.
Implants – screws		
Cortical screw Ø 4.5 mm; fully threaded; self tapping; stainless steel		
2.152.14	length 14 mm	3
2.152.16	length 16 mm	3
2.152.18	length 18 mm	3
2.152.20	length 20 mm	3
2.152.22	length 22 mm	3
2.152.24	length 24 mm	3
2.152.26	length 26 mm	3
2.152.28	length 28 mm	3
2.152.30	length 30 mm	3
2.152.32	length 32 mm	3
2.152.34	length 34 mm	3
2.152.36	length 36 mm	3
2.152.38	length 38 mm	3
2.152.40	length 40 mm	3
2.152.42	length 42 mm	3
2.152.44	length 44 mm	3
2.152.46	length 46 mm	3
2.152.48	length 48 mm	3
2.152.50	length 50 mm	2
2.152.52	length 52 mm	2
2.152.54	length 54 mm	2
2.152.56	length 56 mm	2
2.152.58	length 58 mm	2
2.152.60	length 60 mm	2

Item no.	Item description	Quant.
Implants – screws		
Cortical screw Ø 4.5 mm; fully threaded; self tapping; stainless steel		
2.152.64	length 64 mm	2
2.152.68	length 68 mm	2
2.152.70	length 70 mm	2
2.152.72	length 72 mm	2

Cancellous screw Ø 6.5 mm; thread 16; stainless steel		
2.170.30	length 30 mm	3
2.170.35	length 35 mm	3
2.170.40	length 40 mm	3
2.170.45	length 45 mm	3
2.170.50	length 50 mm	3
2.170.55	length 55 mm	3
2.170.60	length 60 mm	3
2.170.65	length 65 mm	3
2.170.70	length 70 mm	3
2.170.75	length 75 mm	3
2.170.80	length 80 mm	3
2.170.85	length 85 mm	3
2.170.90	length 90 mm	3
2.170.95	length 95 mm	3
2.170.100	length 100 mm	3
2.170.105	length 105 mm	3
2.170.110	length 110 mm	3

Set Screw container for Large fragment

stainless steel; Set no. 19.168.20

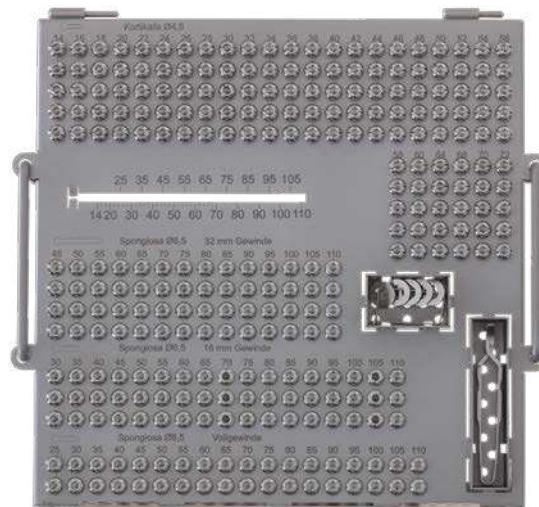

Set no. 19.168.20 *  internal hexagon

Item no.	Item description	Quant.
Implants – screws		
Cancellous screw Ø 6.5 mm; thread 32; stainless steel		
2.180.45	length 45 mm	3
2.180.50	length 50 mm	3
2.180.55	length 55 mm	3
2.180.60	length 60 mm	3
2.180.65	length 65 mm	3
2.180.70	length 70 mm	3
2.180.75	length 75 mm	3
2.180.80	length 80 mm	3
2.180.85	length 85 mm	3
2.180.90	length 90 mm	3
2.180.95	length 95 mm	3
2.180.100	length 100 mm	3
2.180.105	length 105 mm	3
2.180.110	length 110 mm	3

Instruments		
2.954.01	screw forceps; self holding	1
20.502.00	holding clamp; big	1

Implants – washers		
2.200.03	washer; outside Ø 13 mm / inside Ø 6.7 mm; stainless steel	3

* Example illustration can show different number of screws.

Item no.	Item description	Quant.
Implants – screws		
Cancellous screw Ø 6.5 mm; fully threaded; stainless steel		
2.190.25	length 25 mm	2
2.190.30	length 30 mm	2
2.190.35	length 35 mm	2
2.190.40	length 40 mm	2
2.190.45	length 45 mm	2
2.190.50	length 50 mm	2
2.190.55	length 55 mm	2
2.190.60	length 60 mm	2
2.190.65	length 65 mm	2
2.190.70	length 70 mm	2
2.190.75	length 75 mm	2
2.190.80	length 80 mm	2
2.190.85	length 85 mm	2
2.190.90	length 90 mm	2
2.190.95	length 95 mm	2
2.190.100	length 100 mm	2
2.190.105	length 105 mm	2
2.190.110	length 110 mm	2

Container		
19.168.00	screw container for large fragment; empty	1

Schanz screws

Titanium



Item no. 7.122.10



Item no. 7.141.10

Item no. Item description

Schanz screw with flat point and triangular shank

7.120.01	Schanz screw with flat point and triangular shank, Ø3x60, thread 20, ti
7.120.03	Schanz screw with flat point and triangular shank, Ø3x80, thread 25, ti
7.120.05	Schanz screw with flat point and triangular shank, Ø3x100, thread 30, ti
7.121.01	Schanz screw with flat point and triangular shank, Ø4x60, thread 20, ti
7.121.02	Schanz screw with flat point and triangular shank, Ø4x70, thread 20, ti
7.121.03	Schanz screw with flat point and triangular shank, Ø4x80, thread 25, ti
7.121.04	Schanz screw with flat point and triangular shank, Ø4x90, thread 30, ti
7.121.05	Schanz screw with flat point and triangular shank, Ø4x100, thread 30, ti
7.121.06	Schanz screw with flat point and triangular shank, Ø4x110, thread 35, ti
7.121.08	Schanz screw with flat point and triangular shank, Ø4x130, thread 40, ti
7.121.10	Schanz screw with flat point and triangular shank, Ø4x150, thread 40, ti
7.121.12	Schanz screw with flat point and triangular shank, Ø4x170, thread 50, ti
7.122.03	Schanz screw with flat point and triangular shank, Ø5x80, thread 25, ti
7.122.05	Schanz screw with flat point and triangular shank, Ø5x100, thread 30, ti
7.122.07	Schanz screw with flat point and triangular shank, Ø5x120, thread 35, ti
7.122.08	Schanz screw with flat point and triangular shank, Ø5x130, thread 40, ti
7.122.10	Schanz screw with flat point and triangular shank, Ø5x150, thread 40, ti
7.122.12	Schanz screw with flat point and triangular shank, Ø5x170, thread 50, ti
7.122.13	Schanz screw with flat point and triangular shank, Ø5x200, thread 50, ti
7.122.14	Schanz screw with flat point and triangular shank, Ø5x250, thread 50, ti
7.123.07	Schanz screw with flat point and triangular shank, Ø6x120, thread 35, ti
7.123.10	Schanz screw with flat point and triangular shank, Ø6x150, thread 40, ti
7.123.12	Schanz screw with flat point and triangular shank, Ø6x170, thread 50, ti

Schanz screw with triangular shank

7.140.01	Schanz screw with triangular shank, Ø3x60, thread 20, self tapping, ti
7.140.03	Schanz screw with triangular shank, Ø3x80, thread 25, self tapping, ti
7.140.05	Schanz screw with triangular shank, Ø3x100, thread 30, self tapping, ti
7.141.01	Schanz screw with triangular shank, Ø4x60, thread 20, self tapping, ti
7.141.02	Schanz screw with triangular shank, Ø4x70, thread 20, self tapping, ti
7.141.03	Schanz screw with triangular shank, Ø4x80, thread 25, self tapping, ti

Schanz screws

Titanium



Item no. 7.143.10



Item no. 7.126.10

Item no.	Item description
7.141.04	Schanz screw with triangular shank, Ø4x90, thread 30, self tapping, ti
7.141.05	Schanz screw with triangular shank, Ø4x100, thread 30, self tapping, ti
7.141.06	Schanz screw with triangular shank, Ø4x110, thread 35, self tapping, ti
7.141.08	Schanz screw with triangular shank, Ø4x130, thread 40, self tapping, ti
7.141.10	Schanz screw with triangular shank, Ø4x150, thread 40, self tapping, ti
7.141.12	Schanz screw with triangular shank, Ø4x170, thread 50, self tapping, ti
7.142.03	Schanz screw with triangular shank, Ø5x80, thread 25, self tapping, ti
7.142.05	Schanz screw with triangular shank, Ø5x100, thread 30, self tapping, ti
7.142.07	Schanz screw with triangular shank, Ø5x120, thread 35, self tapping, ti
7.142.08	Schanz screw with triangular shank, Ø5x130, thread 40, self tapping, ti
7.142.10	Schanz screw with triangular shank, Ø5x150, thread 40, self tapping, ti
7.142.12	Schanz screw with triangular shank, Ø5x170, thread 50, self tapping, ti
7.142.13	Schanz screw with triangular shank, Ø5x200, thread 50, self tapping, ti
7.142.14	Schanz screw with triangular shank, Ø5x250, thread 50, self tapping, ti
7.143.05	Schanz screw with triangular shank, Ø6x100, thread 30, self tapping, ti
7.143.07	Schanz screw with triangular shank, Ø6x120, thread 35, self tapping, ti
7.143.09	Schanz screw with triangular shank, Ø6x145, thread 40, self tapping, ti
7.143.10	Schanz screw with triangular shank, Ø6x150, thread 40, self tapping, ti
7.143.11	Schanz screw with triangular shank, Ø6x165, thread 40, self tapping, ti
7.143.12	Schanz screw with triangular shank, Ø6x190, thread 50, self tapping, ti
Schanz screw with trocar point and triangular shank	
7.125.01	Schanz screw with trocar point and triangular shank, Ø3x60, thread 20, ti
7.125.03	Schanz screw with trocar point and triangular shank, Ø3x80, thread 25, ti
7.125.05	Schanz screw with trocar point and triangular shank, Ø3x100, thread 30, ti
7.126.01	Schanz screw with trocar point and triangular shank, Ø4x60, thread 20, ti
7.126.02	Schanz screw with trocar point and triangular shank, Ø4x70, thread 20, ti
7.126.03	Schanz screw with trocar point and triangular shank, Ø4x80, thread 25, ti
7.126.04	Schanz screw with trocar point and triangular shank, Ø4x90, thread 30, ti
7.126.05	Schanz screw with trocar point and triangular shank, Ø4x100, thread 35, ti
7.126.06	Schanz screw with trocar point and triangular shank, Ø4x110, thread 35, ti
7.126.08	Schanz screw with trocar point and triangular shank, Ø4x130, thread 40, ti
7.126.10	Schanz screw with trocar point and triangular shank, Ø4x150, thread 40, ti

Schanz screws

Titanium



Item no. 7.128.10



Item no. 7.144.13

Item no.	Item description
7.126.12	Schanz screw with trocar point and triangular shank, Ø4x170, thread 50, ti
7.127.03	Schanz screw with trocar point and triangular shank, Ø5x80, thread 25, ti
7.127.05	Schanz screw with trocar point and triangular shank, Ø5x100, thread 30, ti
7.127.07	Schanz screw with trocar point and triangular shank, Ø5x120, thread 35, ti
7.127.08	Schanz screw with trocar point and triangular shank, Ø5x130, thread 40, ti
7.127.10	Schanz screw with trocar point and triangular shank, Ø5x150, thread 40, ti
7.127.12	Schanz screw with trocar point and triangular shank, Ø5x170, thread 50, ti
7.127.13	Schanz screw with trocar point and triangular shank, Ø5x200, thread 50, ti
7.127.14	Schanz screw with trocar point and triangular shank, Ø5x250, thread 50, ti
7.128.05	Schanz screw with trocar point and triangular shank, Ø6x100, thread 30, ti
7.128.07	Schanz screw with trocar point and triangular shank, Ø6x120, thread 35, ti
7.128.09	Schanz screw with trocar point and triangular shank, Ø6x145, thread 40, ti
7.128.10	Schanz screw with trocar point and triangular shank, Ø6x150, thread 40, ti
7.128.11	Schanz screw with trocar point and triangular shank, Ø6x165, thread 40, ti
7.128.13	Schanz screw with trocar point and triangular shank, Ø6x200, thread 50, ti
Schanz screw with conical thread	
7.154.70	Schanz screw with conical thread, Ø4x70, thread 20, ti
Schanz screw with drilling point and triangular shank	
7.144.125	Schanz screw with drilling point and triangular shank, Ø5x175, ti
7.144.13	Schanz screw with drilling point and triangular shank, Ø5x200, ti
7.144.14	Schanz screw with drilling point and triangular shank, Ø5x250, ti

Schanz screws

Stainless Steel



Item no. 6.122.10



Item no. 6.141.10

Item no.	Item description
----------	------------------

Schanz screw with flat point and triangular shank

6.120.03	Schanz screw with flat point and triangular shank, Ø3x80, thread 25, stainless steel
6.120.05	Schanz screw with flat point and triangular shank, Ø3x100, thread 30, stainless steel
6.121.01	Schanz screw with flat point and triangular shank, Ø4x60, thread 20, stainless steel
6.121.03	Schanz screw with flat point and triangular shank, Ø4x80, thread 25, stainless steel
6.121.05	Schanz screw with flat point and triangular shank, Ø4x100, thread 30, stainless steel
6.121.12	Schanz screw with flat point and triangular shank, Ø4x170, thread 50, stainless steel
6.122.03	Schanz screw with flat point and triangular shank, Ø5x80, thread 25, stainless steel
6.122.05	Schanz screw with flat point and triangular shank, Ø5x100, thread 30, stainless steel
6.122.07	Schanz screw with flat point and triangular shank, Ø5x120, thread 35, stainless steel
6.122.10	Schanz screw with flat point and triangular shank, Ø5x150, thread 40, stainless steel
6.122.12	Schanz screw with flat point and triangular shank, Ø5x170, thread 50, stainless steel
6.122.13	Schanz screw with flat point and triangular shank, Ø5x200, thread 50, stainless steel

Schanz screw with triangular shank

6.140.01	Schanz screw with triangular shank, Ø3x60, thread 20, self tapping, stainless steel
6.140.03	Schanz screw with triangular shank, Ø3x80, thread 25, self tapping, stainless steel
6.140.05	Schanz screw with triangular shank, Ø3x100, thread 30, self tapping, stainless steel
6.141.01	Schanz screw with triangular shank, Ø4x60, thread 20, self tapping, stainless steel
6.141.03	Schanz screw with triangular shank, Ø4x80, thread 25, self tapping, stainless steel
6.141.06	Schanz screw with triangular shank, Ø4x110, thread 35, self tapping, stainless steel
6.141.08	Schanz screw with triangular shank, Ø4x130, thread 40, self tapping, stainless steel
6.141.10	Schanz screw with triangular shank, Ø4x150, thread 40, self tapping, stainless steel
6.141.12	Schanz screw with triangular shank, Ø4x170, thread 50, self tapping, stainless steel
6.142.07/25	Schanz screw with triangular shank, Ø5x120, thread 25, self tapping, stainless steel
6.142.10	Schanz screw with triangular shank, Ø5x150, thread 40, self tapping, stainless steel
6.142.10/30	Schanz screw with triangular shank, Ø5x150, thread 30, self tapping, stainless steel
6.142.12	Schanz screw with triangular shank, Ø5x170, thread 50, self tapping, stainless steel
6.142.13	Schanz screw with triangular shank, Ø5x200, thread 50, self tapping, stainless steel
6.143.05	Schanz screw with triangular shank, Ø6x100, thread 30, self tapping, stainless steel
6.143.07	Schanz screw with triangular shank, Ø6x120, thread 35, self tapping, stainless steel
6.143.12	Schanz screw with triangular shank, Ø6x190, thread 50, self tapping, stainless steel

Schanz screws

Stainless Steel



Item no. 6.126.10



Item no. 6.144.14

Item no. Item description

Schanz screw with trocar point and triangular shank

6.125.01	Schanz screw with trocar point and triangular shank, Ø3x60, thread 20, stainless steel
6.125.03	Schanz screw with trocar point and triangular shank, Ø3x80, thread 25, stainless steel
6.125.05	Schanz screw with trocar point and triangular shank, Ø3x100, thread 30, stainless steel
6.126.00	Schanz screw with trocar point and triangular shank, Ø3/Ø4x80, thread 25, stainless steel
6.126.03	Schanz screw with trocar point and triangular shank, Ø4x80, thread 25, stainless steel
6.126.05	Schanz screw with trocar point and triangular shank, Ø4x100, thread 35, stainless steel
6.126.06	Schanz screw with trocar point and triangular shank, Ø4x110, thread 35, stainless steel
6.126.08	Schanz screw with trocar point and triangular shank, Ø4x130, thread 40, stainless steel
6.126.10	Schanz screw with trocar point and triangular shank, Ø4x150, thread 40, stainless steel
6.126.12	Schanz screw with trocar point and triangular shank, Ø4x170, thread 50, stainless steel
6.126.348	Schanz screw with trocar point and triangular shank, Ø3/Ø4x80, thread 20, stainless steel
6.127.05	Schanz screw with trocar point and triangular shank, Ø5x100, thread 30, stainless steel
6.127.07	Schanz screw with trocar point and triangular shank, Ø5x120, thread 35, stainless steel
6.127.08	Schanz screw with trocar point and triangular shank, Ø5x130, thread 40, stainless steel
6.127.09	Schanz screw with trocar point and triangular shank, Ø5x145, thread 40, stainless steel
6.127.10	Schanz screw with trocar point and triangular shank, Ø5x150, thread 40, stainless steel
6.127.11	Schanz screw with trocar point and triangular shank, Ø5x165, thread 50, stainless steel
6.127.12	Schanz screw with trocar point and triangular shank, Ø5x170, thread 50, stainless steel
6.127.125	Schanz screw with trocar point and triangular shank, Ø5x175, thread 50, stainless steel
6.127.13	Schanz screw with trocar point and triangular shank, Ø5x200, thread 50, stainless steel
6.127.14	Schanz screw with trocar point and triangular shank, Ø5x250, thread 50, stainless steel
6.128.07	Schanz screw with trocar point and triangular shank, Ø6x120, thread 35, stainless steel
6.128.11	Schanz screw with trocar point and triangular shank, Ø6x165, thread 40, stainless steel
6.128.13	Schanz screw with trocar point and triangular shank, Ø6x200, thread 50, stainless steel

Schanz screw reduced

6.127.80	Schanz screw reduced, Ø4/Ø5x80, thread 25, stainless steel
----------	--

Schanz screw with drilling point and triangular shank

6.144.125	Schanz screw with drilling point and triangular shank, Ø5x175, stainless steel
6.144.14	Schanz screw with drilling point and triangular shank, Ø5x250, stainless steel

Product overview Screw heads with conical thread



pict. 8.933.02



pict. 8.936.03

Item no.	Item description
----------	------------------

Mini fragment

8.933.02	Screw head with conical thread \varnothing 3.0 mm x 2.0 mm; mini fragment; stainless steel
----------	--

Small fragment

8.934.025	Screw head with conical thread \varnothing 5.0 mm x 2.5 mm; system 2,7; stainless steel
-----------	---

9.934.025	Screw head with conical thread \varnothing 5.0 mm x 2.5 mm; system 2,7; titanium
-----------	--

8.936.03	Screw head with conical thread \varnothing 6.0 mm x 3.0 mm; small fragment; stainless steel
----------	---

9.936.03	Screw head with conical thread \varnothing 6.0 mm x 3.0 mm; small fragment; titanium
----------	--

Large fragment

8.946.05	Screw head with conical thread \varnothing 8.0 mm x 5.0 mm; large fragment; stainless steel
----------	---

9.946.05	Screw head with conical thread \varnothing 8.0 mm x 5.0 mm; large fragment; titanium
----------	--

Information:

All item no. are available on request.



We hope, this offer meets your expectations
and we would be happy to receive your order.

SYSTEMS

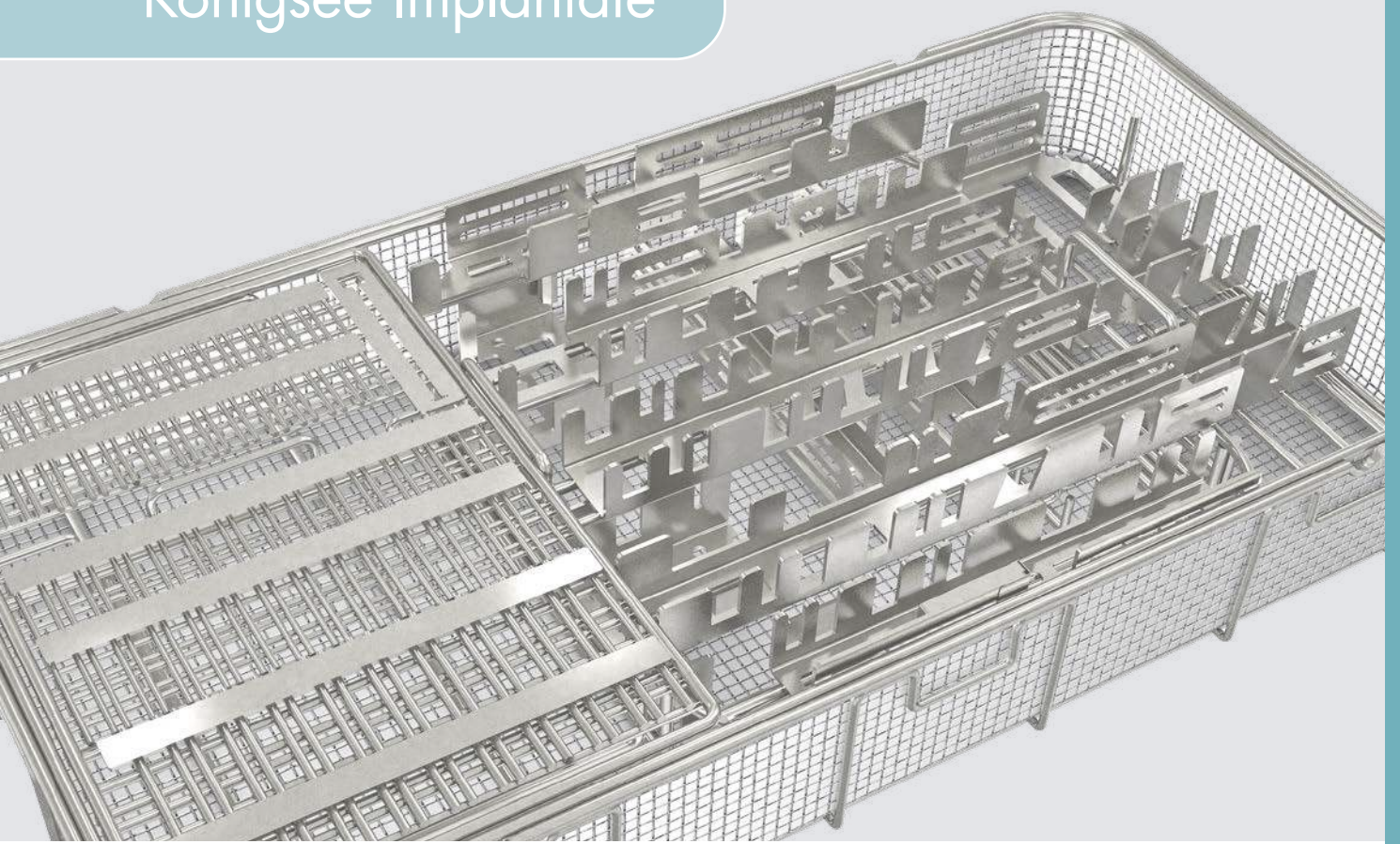
Königsee Implantate



Your Partner in Osteosynthesis

-  Mini fragment
-  Small fragment
-  Large fragment

Rep-Ret-System

Mini fragment; Set no. 19.426.00



Item no. 19.426.00

Item description	Item no.	Quant.
Instruments and accessories		
Thread rod Rep-Ret mini fragment Ø 1.6 mm; length 120 mm	2.917.01	10
Knurled nut Rep-Ret mini fragment Ø 4.0 mm; length 30 mm; Inside thread M 1.6	2.917.02	2
Distance sleeve Rep-Ret mini fragment length 30 mm; Inside diameter 2.4 mm	2.917.30	2
Distance sleeve Rep-Ret mini fragment length 40 mm; Inside diameter 2.4 mm	2.917.40	2
Distance sleeve Rep-Ret mini fragment length 50 mm; Inside diameter 2.4 mm	2.917.50	2
Guide rod with ball Rep-Ret Ø 2.0 mm; length 120 mm	2.917.04	2
Storage Sorting bank Rep-Ret mini fragment 160 mm x 105 mm x 26 mm	20.150.22	1
Positioning aid: Kirschner wire with trocar point and round end; Ø 1.0 mm; length 150 mm; stainless steel	6.031.10	3

Rep-Ret-System

small fragment; Set no. 19.424.00

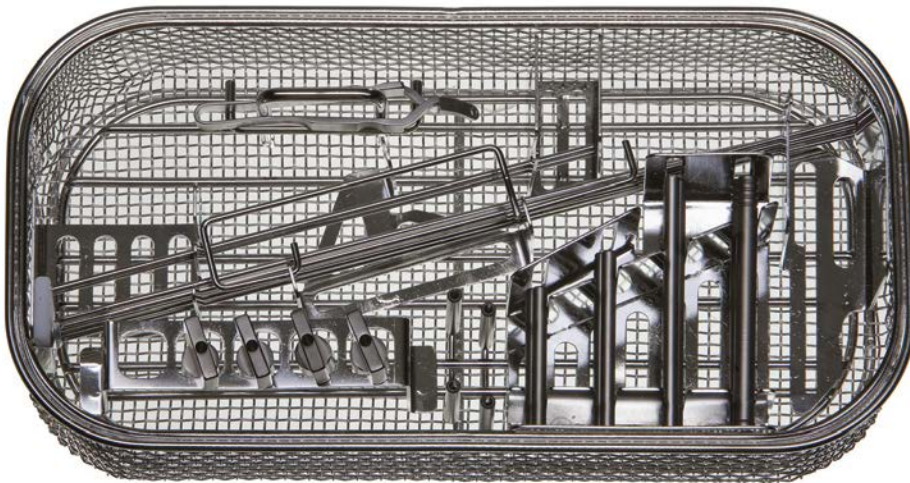

Item no. 19.424.00

Item description	Item no.	Quant.	Depiction
Instruments and accessories			
Thread rod Rep-Ret small fragment Ø 2.0 mm; length 220 mm	2.916.01	10	
Sleeve with ball Rep-Ret small fragment length 70 mm; inside diameter 2.2 mm	2.916.05	4	
Cap wing nut Rep-Ret small fragment thread diameter M2	2.916.02	4	
Distance sleeve Rep-Ret small fragment Ø 4.0 mm; length 30 mm; inside diameter 2.4 mm	2.916.30	4	
Distance sleeve Rep-Ret small fragment Ø 4.0 mm; length 40 mm; inside diameter 2.4 mm	2.916.40	4	
Distance sleeve Rep-Ret small fragment Ø 4.0 mm; length 50 mm; inside diameter 2.4 mm	2.916.50	4	
Distance sleeve Rep-Ret small fragment Ø 4.0 mm; length 70 mm; inside diameter 2.4 mm	2.916.70	4	
Guide rod with ball Rep-Ret; Ø 2.0 mm; length 150 mm	2.916.04	2	
Screw forceps; self holding	2.954.01	1	
Perforated autoclavable container with inset for instruments for Rep-Ret-System small fragment	19.422.00	1	

Rep-Ret-System

large fragment; Set no. 19.425.00

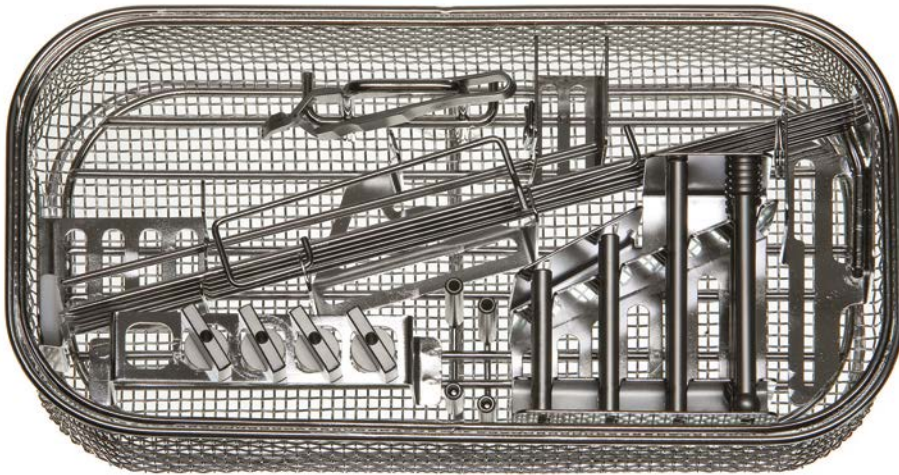

Item no. 19.425.00

Item description	Item no.	Quant.	Depiction
Instruments and accessories			
Thread rod Rep-Ret large fragment Ø 2.5 mm; length 220 mm	2.915.01	10	
Sleeve with ball Rep-Ret large fragment length 70 mm; inside diameter 2.7 mm	2.915.05	4	
Cap wing nut Rep-Ret large fragment thread diameter M 2.5	2.915.02	4	
Distance sleeve Rep-Ret large fragment Ø 5.0 mm; length 30 mm; inside diameter 2.8 mm	2.915.30	4	
Distance sleeve Rep-Ret large fragment Ø 5.0 mm; length 40 mm; inside diameter 2.8 mm	2.915.40	4	
Distance sleeve Rep-Ret large fragment Ø 5.0 mm; length 50 mm; inside diameter 2.8 mm	2.915.50	4	
Distance sleeve Rep-Ret large fragment Ø 5.0 mm; length 70 mm; inside diameter 2.8 mm	2.915.70	4	
Guide rod with ball Rep-Ret Ø 2.0 mm; length 150 mm	2.916.04	2	
Screw forceps; self holding	2.954.01	1	
Perforated autoclavable container with inset for instruments for Rep-Ret-System large fragment	19.423.00	1	

IMPLANTEX⁷®

Set-Nr. 19.511.10

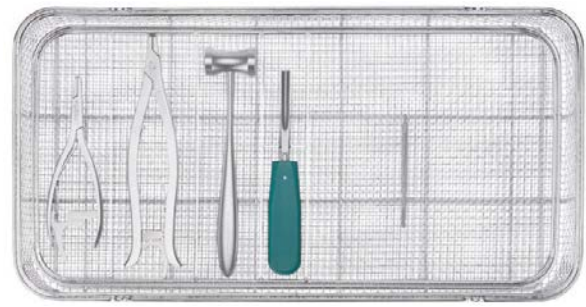
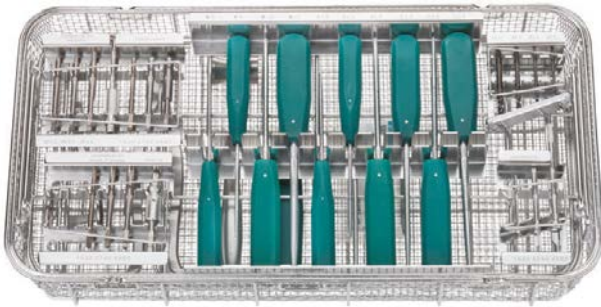

Item description	Item no.	quantity
Instruments		
cross-head screwdriver with plastic-handle; size 1.5	2.9366.15	1
cross-head screwdriver with plastic-handle; size 2.5	2.9366.25	1
cross-head screwdriver with plastic-handle; size 3.5	2.9366.35	1
screwdriver with plastic-handle for six-lobe 6	2.9386.06	1
screwdriver with plastic-handle for six-lobe 8	2.9386.08	1
screwdriver with plastic-handle for six-lobe 15	2.9386.15	1
screwdriver with plastic-handle for six-lobe 25	2.9386.25	1
hex screwdriver with plastic-handle for screws Ø 1.5 mm - Ø 2.0 mm; AF 1.5; conical	2.9406.15	1
hex screwdriver with plastic-handle for screws Ø 2.7 mm - Ø 4.0 mm; AF 2.5; conical	2.9406.25	1
hex screwdriver with plastic-handle for screws Ø 4.5 mm - Ø 7.0 mm; AF 3.5; length 215 mm	2.9406.35	1
screwdriver inset for +10	2.941.110	0
screwdriver for extraction for quick coupling; wrench width 1.5	2.948.15A	1
screwdriver for extraction for quick coupling; wrench width 2.5	2.948.25A	1
screwdriver for extraction for quick coupling; wrench width 3.5	2.948.35A	1
metal hammer; weight 300 g	2.975.03	1
drill bit; Ø 2.5 mm x 46 mm; spiral length 14 mm; double spiral; DLC-coated	2.9042.025	1
drill bit; Ø 3.0 mm x 50 mm; spiral length 17 mm; double spiral; DLC-coated	2.9042.030	1
drill bit; Ø 4.0 mm x 54 mm; spiral length 22 mm; double spiral; DLC-coated	2.9042.040	1
drill bit; Ø 5.0 mm x 62 mm; spiral length 26 mm; double spiral; DLC-coated	2.9042.050	1
hollow cutter with quick coupling for screws Ø 1.5 mm - Ø 2.0 mm	2.9101.15	1
hollow cutter with quick coupling for screws Ø 2.7 mm - Ø 4.0 mm	2.9101.35	1
hollow cutter with quick coupling for screws Ø 4.5 mm - Ø 7.0 mm	2.9101.45	1
screwdriver for extraction from shank of screws Ø 1.5 mm to Ø 2.0 mm for quick coupling	2.9481.15	1
screwdriver for extraction from shank of screws Ø 2.7 mm to Ø 4.0 mm for quick coupling	2.9481.27	1
screwdriver for extraction from shank of screws Ø 4.5 mm to Ø 6.0 mm for quick coupling	2.9481.45	1
gauge with plastic-handle	10.2406.05	1
coupling device from dental coupling to quick coupling	10.305.10	1
screw holding forceps; mini fragment	10.426.10	1
screw holding forceps; small fragment and large fragment	10.426.20	1
countersink for dental coupling; length 57 mm; for screws Ø 1.5 mm and Ø 2.0 mm	10.505.15	1
countersink for quick coupling; length 72 mm; for screws Ø 2.7 mm / Ø 3.5 mm / Ø 4.0 mm	10.505.40	1
countersink for quick coupling; length 110 mm; for screws Ø 4.5 mm and Ø 6.5 mm	10.505.81	1
Thandle with quick coupling; length 93.5 mm	10.305.05	1
Container		
Perforated autoclavable container with inset for IMPLANTEX ⁷ ; english	19.510.10	1

IMPLANTEX[®]

Set-Nr. 19.511.10

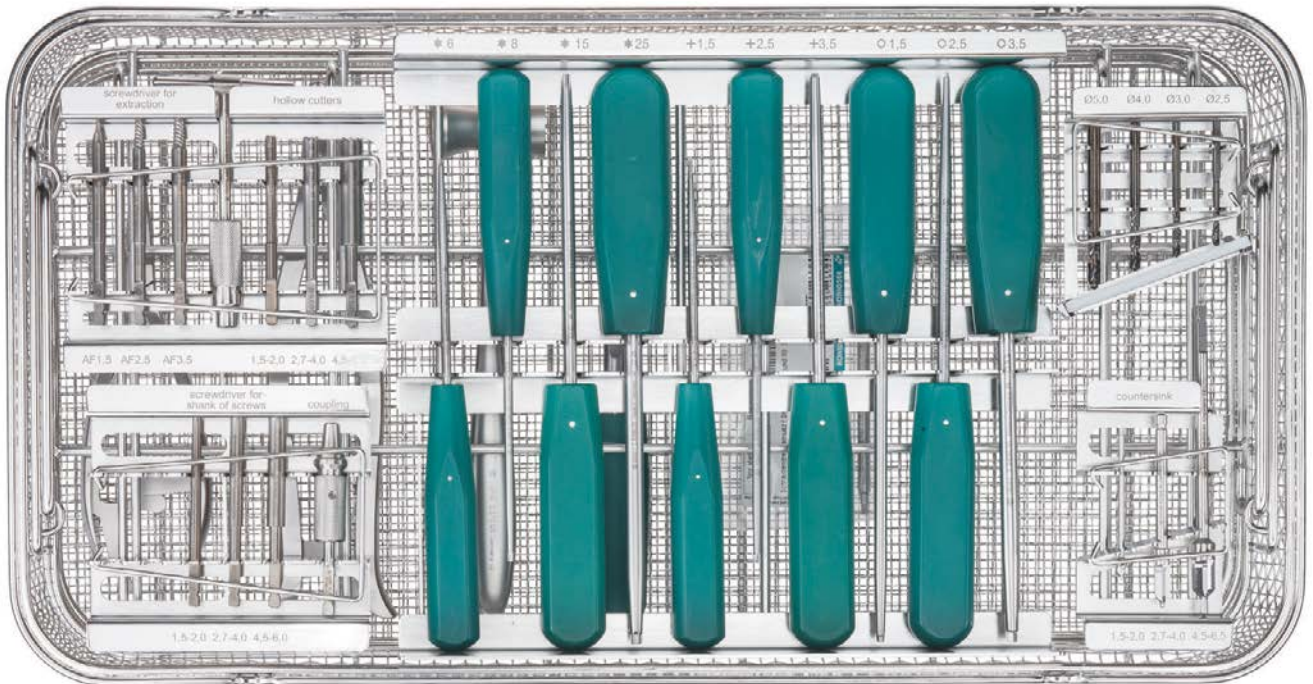

16/05/2014/KaMo



Königsee Implantate GmbH
 OT Aschau - Am Sand 4
 07426 Allendorf /Germany
 Fon + 49 36738 498-0
 Fax + 49 36738 498-559
 E-Mail: export@koenigsee-implantate.de

For further information please visit:
www.koenigsee-implantate.de

Set Instruments 2.7 SL

for screws Ø 2.7 mm; Set no. 19.027.10I

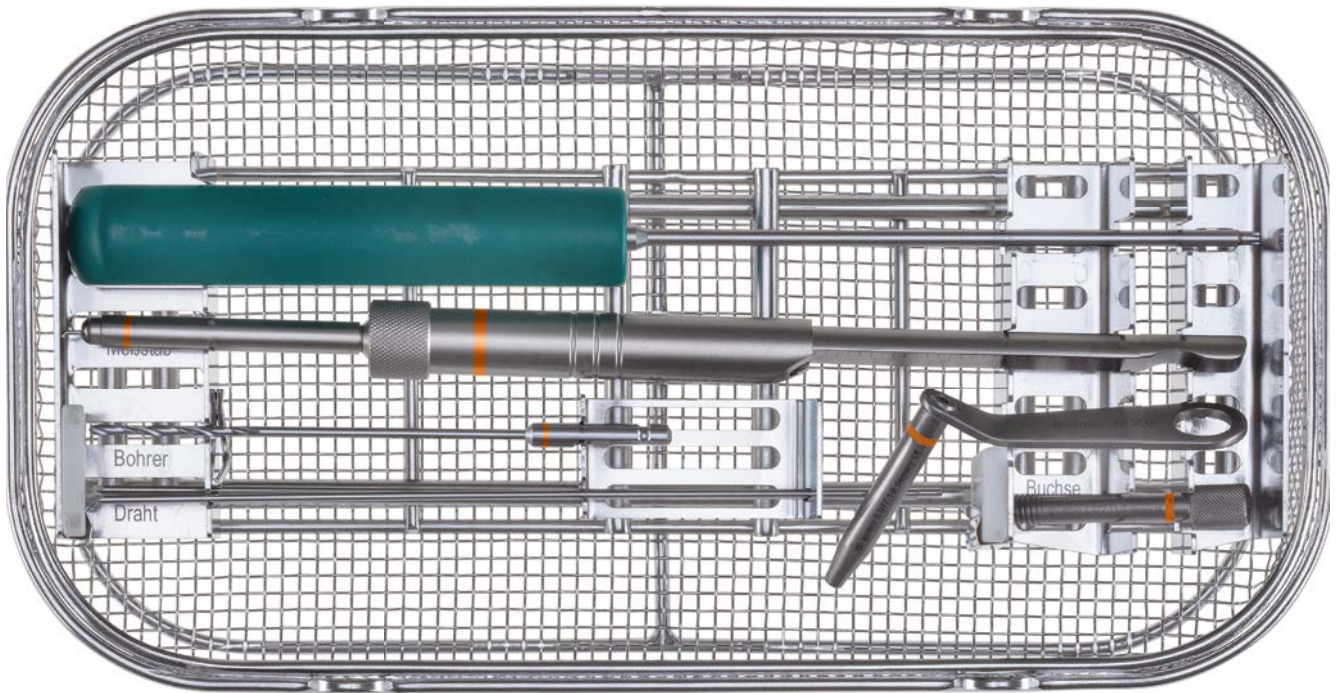

Set no. 19.027.10I Six lobe

Item no.	Item description	Quant.
Instruments		
2.904.03	drill bit for quick coupling; Ø 2.0 x 105; spiral length 30; double spiral	1
2.9386.10	screwdriver with handle for six-lobe 10	1
2.953.65	gauge w. clasp for screws Ø2.7; measuring range 60	1
2.977.19	drill guide with handle for variable angle stable screwing 2.7; length 42	1
2.977.11/3	drill guide for angle stable screwing 2.7; length 44; single thread with knurl	2

Item no.	Item description	Quant.
Wires		
6.031.16	Kirschner wire with trocar point and round end; Ø 1.6 x 150; st.st.	5

Container		
19.027.01	Perforated autoclavable container for instruments 2.7	1

Optionally available:

- 10.180.05 – guide block for distal radius plate 5.9823.xx; right
- 10.181.05 – guide block for distal radius plate 5.9833.xx; left
- 10.180.07 – guide block for distal radius plate 5.9843.xx; right
- 10.181.07 – guide block for distal radius plate 5.9853.xx; left

Can be combined with: 19.1161.00 19.1161.00PS 19.1161.00PS+

Module standard Minifragment - MFI

for MFI-implants and instruments - Titanium

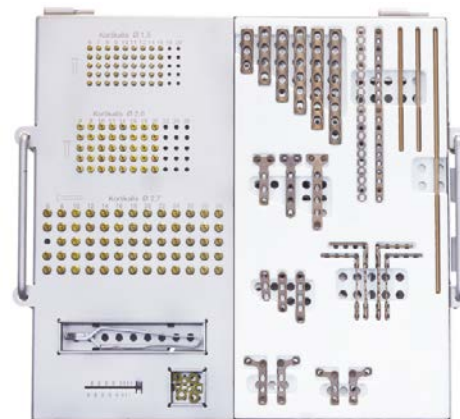

Code No.
Set complete
Titanium
19.141.00

■ Instruments

Item designation	Code No.	Quantity
drill bit for quick coupling, Ø1.1x65, spiral length 26, double spiral	2.904.01	1
drill bit for quick coupling, Ø1.5x88, spiral length 30, double spiral	2.904.02	1
drill bit for quick coupling, Ø2.0x105, spiral length 50, double spiral	2.904.03	1
drill bit for quick coupling, Ø2.7x105, spiral length 50, double spiral	2.904.07	1
countersink for quick coupling, length 72, for screws Ø2.7/Ø3.5 / Ø4.0	10.505.40	1
countersink for dental coupling, length 57, for screws Ø1.5/Ø2.0	10.505.15	1
tap for dental coupling for cortical screws, Ø1.5x50	2.924.15	1
tap for dental coupling for cortical screws, Ø2.0x53	2.924.20	1
tap for quick coupling for cortical screws, Ø2.7x100	2.924.27	1
handle with dental coupling	10.205.05	1
T-handle with quick coupling, length 93.5	10.305.05	1
double drill guide, Ø1.1/Ø1.5	10.500.07	1
double drill guide, Ø2.0/Ø2.7	10.500.09	1
triple drill guide Ø2.0	10.520.20	1
hex screwdriver with holding sleeve for screw Ø1.5 to Ø2.0	2.946.15	1
hex screwdriver with handle for screw Ø2.7 until Ø4.0, wrench width 2.5	2.940.25SA	1
gauge with clasp for screws Ø1.5 and Ø2, measuring range 40	2.953.15	1
gauge with clasp for screws Ø2.7, measuring range 70	2.953.27	1
sharp hook	10.508.00	1
screw forceps, self holding	2.954.01	1
bending device for plates for mini fragment 1.5 and 2.0	2.911.04	2
bending device for plates for mini fragment 2.0 and small fragment 3.5	2.911.03	1
bending forceps for mini plates 1.5 until 2.0	10.428.01	2
holding forceps for mini plates	10.429.00	1
repositioning forceps with teeth, length 135	10.425.135	1
extraction forceps for wires, flat	10.421.01	1
bone lever, width 6, narrow	10.507.06	2
bone lever, width 8, narrow	10.507.08	2
bone lever, width 1.5, broad	10.507.15	1
elavator, breadth 3.0, extra narrow, arched, straight edge	10.506.01	1
power cutter for wires to maximum Ø2.0	6.906.01	1

■ Plates

One quarter tubular plate Item designation	Code No.	Quantity
one quarter tubular plate w. collar 2.7; 3holes; 23x7; ti	5.412.03	0
one quarter tubular plate w. collar 2.7; 4holes; 31x7; ti	5.412.04	0
one quarter tubular plate w. collar 2.7; 5holes; 39x7; ti	5.412.05	0
one quarter tubular plate w. collar 2.7; 6holes; 47x7; ti	5.412.06	0
one quarter tubular plate w. collar 2.7; 7holes; 55x7; ti	5.412.07	0
one quarter tubular plate w. collar 2.7; 8holes; 63x7; ti	5.412.08	0

Straight Miniplates Item designation	Code No.	Quantity
straight mini plate with round holes 2.0; 3holes; 17x5; ti	5.900.03	1
straight mini plate with round holes 2.0; 4holes; 23x5; ti	5.900.04	1
straight mini plate with round holes 2.0; 5holes; 29x5; ti	5.900.05	1

■ Plates

Mini L-plates Item designation	Code No.	Quantity
Mini L-plate 2.0/1.5; 2h; 20x5; oblique, r; ti	5.920.02	1
Mini L-plate 2.0/1.5; 3h; 26x5; oblique, r; ti	5.920.03	1
Mini L-plate 2.0/1.5; 2h; 20x5; oblique, l; ti	5.921.02	1
Mini L-plate 2.0/1.5; 3h; 26x5; oblique, l; ti	5.921.03	1

Mini T-plates Item designation	Code No.	Quantity
Mini T-plate 2.0/2.5; 3holes; 29x5.5; lh in shank; ti	5.930.03	1
Mini T-plate 2.0/2.5; 4holes; 36x5.5; lh in shank; ti	5.930.04	1
Mini T-plate 2.0/2.5; 5holes; 43x5.5; lh in shank; ti	5.930.05	2

Mini-adaption plate Item designation	Code No.	Quantity
Mini-adaption plate 2.0; 20holes; 100x5; ti	5.307.20	1

Straight Miniplate Item designation	Code No.	Quantity
Straight miniplate 1.5; 20holes; 100x4.0; ti	5.404.15	1

Mini condylar plate Item designation	Bestell-Nr.	Anzahl
Mini condylar plate 1.5; 36x3,5; pin length 19; pin, right; ti	5.405.15	1
Mini condylar plate 1.5; 36x3,5; pin length 19; pin left; ti	5.405.16	1
Mini condylar plate 2.0; 41x5; pin length 19; pin, right; ti	5.405.20	1
Mini condylar plate 2.0; 41x5; pin length 19; pin, left; ti	5.405.21	1

■ Storage

Item designation	Code No.	Quantity
perforated autoclavable container with inset f. instruments/implants mini fragm.	19.142.00	1



Königsee Implantate GmbH
OT Aschau - Am Sand 4
D-07426 Allendorf
Fon +49 (0) 36738 498-0
Fax +49 (0) 36738 498-19
e-Mail: info@koenigsee-implantate.de

Module standard Minifragment - MFI

for MFI-implantats and instruments - Titanium

■ Screws

Cortical screws diameter 1.5

Item designation	Code No.	Quantity
Cortical screw; diameter 1.5x6;full thread;st;ti	3.100.06	5
Cortical screw; diameter 1.5x7;full thread;st;ti	3.100.07	5
Cortical screw; diameter 1.5x8;full thread;st;ti	3.100.08	5
Cortical screw; diameter 1.5x9;full thread;st;ti	3.100.09	5
Cortical screw; diameter 1.5x10;full thread;st;ti	3.100.10	5
Cortical screw; diameter 1.5x11;full thread;st;ti	3.100.11	5
Cortical screw; diameter 1.5x12;full thread;st;ti	3.100.12	5
Cortical screw; diameter 1.5x14;full thread;st;ti	3.100.14	5
Cortical screw; diameter 1.5x16;full thread;st;ti	3.100.16	5

Cortical screws diameter 2.0

Item designation	Code No.	Quantity
Cortical screw; diameter 2.0x6;full thread;st;ti	3.110.06	5
Cortical screw; diameter 2.0x8;full thread;st;ti	3.110.08	5
Cortical screw; diameter 2.0x10;full thread;st;ti	3.110.10	5
Cortical screw; diameter 2.0x12;full thread;st;ti	3.110.12	5
Cortical screw; diameter 2.0x14;full thread;st;ti	3.110.14	5
Cortical screw; diameter 2.0x16;full thread;st;ti	3.110.16	5
Cortical screw; diameter 2.0x18;full thread;st;ti	3.110.18	5
Cortical screw; diameter 2.0x20;full thread;st;ti	3.110.20	5

Cortical screws diameter 2.7

Item designation	Code No.	Quantity
Cortical screw diameter 2.7x6;full thread;st;ti	3.120.06	5
Cortical screw diameter 2.7x8;full thread;st;ti	3.120.08	5
Cortical screw diameter 2.7x10;full thread;st;ti	3.120.10	5
Cortical screw diameter 2.7x12;full thread;st;ti	3.120.12	5
Cortical screw diameter 2.7x14;full thread;st;ti	3.120.14	5
Cortical screw diameter 2.7x16;full thread;st;ti	3.120.16	5
Cortical screw diameter 2.7x18;full thread;st;ti	3.120.18	5
Cortical screw diameter 2.7x20;full thread;st;ti	3.120.20	5
Cortical screw diameter 2.7x22;full thread;st;ti	3.120.22	5
Cortical screw diameter 2.7x24;full thread;st;ti	3.120.24	5
Cortical screw diameter 2.7x26;full thread;st;ti	3.120.26	5
Cortical screw diameter 2.7x28;full thread;st;ti	3.120.28	5
Cortical screw diameter 2.7x30;full thread;st;ti	3.120.30	5

■ Washer

Item designation	Code No.	Quantity
washer,outside Ø4.5 / inside Ø2.2,ti.	3.200.05	5
washer,outside Ø6.0 / inside Ø3.0,ti.	3.200.10	5
holding clamp, 30 x 16 (for washer)	20.502.00	1

■ Kirschner wire

Item designation	Code No.	Quantity
Kirschner wire with trocar point and round end; diameter 1.0x70;ti	7.011.10	5
Kirschner wire with trocar point and round end; diameter 1.2x70;ti	7.011.12	5
Kirschner wire with trocar point and round end; diameter 1.4x150;ti	7.031.14	5



Königsee Implantate GmbH
OT Aschau - Am Sand 4
D-07426 Allendorf
Fon +49 (0) 36738 498-0
Fax +49 (0) 36738 498-19
e-Mail: info@koenigsee-implantate.de

Module standard Minifragment - MFI

for MFI-implantats and instruments - Titanium

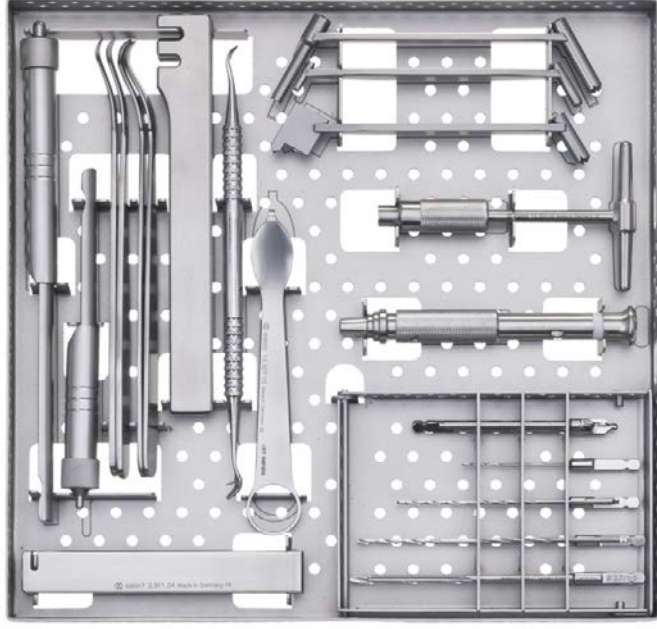
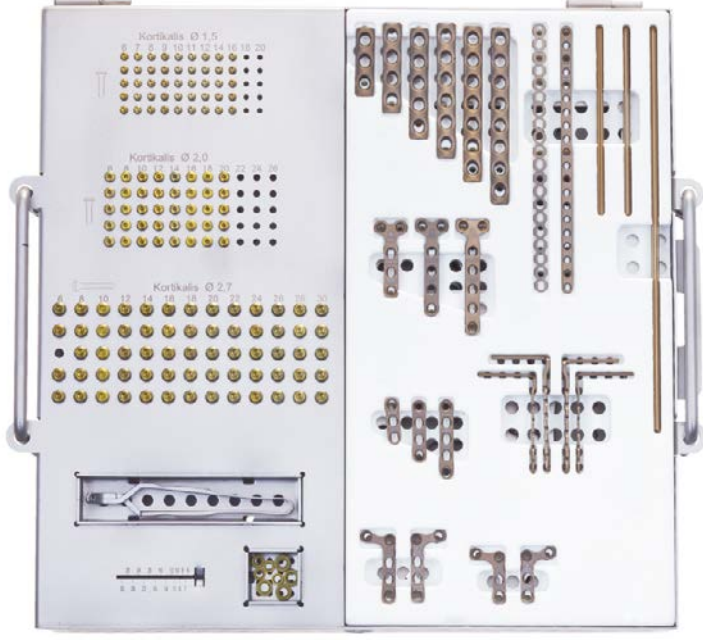

Set Mini Fragment Standard

Implants and instruments; several levels; stainless steel; Set no. 19.140.00

Level 1



Item no. 4.412.05



Item no. 4.900.05



Item no. 4.920.03



Item no. 4.920.02



Item no. 4.930.03



Item no. 4.404.15



Set no. 19.140.00 Level 1

Internal hexagon

Item no.	Item description	Quant.
Implants - plates; stainless steel		
4.412.03	one quarter tubular plate with collar 2.7, 3 holes, 26x7	0
4.412.04	one quarter tubular plate with collar 2.7, 4 holes, 34x7	0
4.412.05	one quarter tubular plate with collar 2.7, 5 holes, 42x7	0
4.412.06	one quarter tubular plate with collar 2.7, 6 holes, 50x7	0
4.412.07	one quarter tubular plate with collar 2.7, 7 holes, 58x7	0
4.412.08	one quarter tubular plate with collar 2.7, 8 holes, 66x7	0

4.900.03	straight mini plate with round holes 2.0, 3 holes, 17x5	1
4.900.04	straight mini plate with round holes 2.0, 4 holes, 23x5	1
4.900.05	straight mini plate with round holes 2.0, 5 holes, 29x5	1

4.920.02	mini L-plate 2.0, 2 holes, 20x5, oblique, right	1
4.920.03	mini L-plate 2.0, 3 holes, 26x5, oblique, right	1
4.921.02	mini L-plate 2.0, 2 holes, 20x5, oblique, left	1
4.921.03	mini L-plate 2.0, 3 holes, 26x5, oblique, left	1

4.930.03	mini T-plate 2.0, 3 holes, 29x5.5, long hole in shank	1
4.930.04	mini T-plate 2.0, 4 holes, 36x5.5, long hole in shank	1
4.930.05	mini T-plate 2.0, 5 holes, 43x5.5, long hole in shank	2

4.307.20	mini adaptation-plate 2.0, 20 holes, 100x5	1
4.404.15	straight mini plate 1.5, 20 holes, 100x4	1

Item no.	Item description	Quant.
Accessories		
2.200.05	washer, outside Ø4.5 / inside Ø2.2	5
2.200.10	washer, outside Ø6 / inside Ø3	5
20.502.01	holding clamp, small	1
2.954.01	screw forceps, self holding	1

Item no.	Item description	Quant.
Wires		
6.011.10	Kirschner wire with trocar point and round end, Ø1x70	5
6.011.12	Kirschner wire with trocar point and round end, Ø1.2x70	5
6.031.14	Kirschner wire with trocar point and round end, Ø1.4x150	5

Set Mini Fragment Standard

Implants and instruments; several levels; stainless steel; Set no. 19.140.00

Level 1



Item no. 2.100.16

Internal hexagon



Item no. 2.110.20

Internal hexagon



Item no. 2.120.20

Internal hexagon

Item no.	Item description	Quant.
Implants - screws		
Cortical screw Ø 1.5 mm; fully threaded; self tapping; stainless steel		
2.100.06	Length 6.0 mm	5
2.100.07	Length 7.0 mm	5
2.100.08	Length 8.0 mm	5
2.100.09	Length 9.0 mm	5
2.100.10	Length 10 mm	5
2.100.11	Length 11 mm	5
2.100.12	Length 12 mm	5
2.100.14	Length 14 mm	5
2.100.16	Length 16 mm	5

Cortical screw Ø 2.0 mm; fully threaded; self tapping; stainless steel		
2.110.06	Length 6.0 mm	5
2.110.08	Length 8.0 mm	5
2.110.10	Length 10 mm	5
2.110.12	Length 12 mm	5
2.110.14	Length 14 mm	5
2.110.16	Length 16 mm	5
2.110.18	Length 18 mm	5
2.110.20	Length 20 mm	5

Item no.	Item description	Quant.
Implants - screws		
Cortical screw Ø 2.7 mm; fully threaded; self tapping; stainless steel		
2.120.06	Length 6.0 mm	5
2.120.08	Length 8.0 mm	5
2.120.10	Length 10 mm	5
2.120.12	Length 12 mm	5
2.120.14	Length 14 mm	5
2.120.16	Length 16 mm	5
2.120.18	Length 18 mm	5
2.120.20	Length 20 mm	5
2.120.22	Length 22 mm	5
2.120.24	Length 24 mm	5
2.120.26	Length 26 mm	5
2.120.28	Length 28 mm	5
2.120.30	Length 30 mm	5

Level 2

Item no.	Item description	Quant.
Instruments		
6.906.01	head and side cutter for wires to maximum Ø1.7	1



Set no. 19.140.00 Level 2

Set Mini Fragment Standard

Implants and instruments; several levels; stainless steel; Set no. 19.140.00

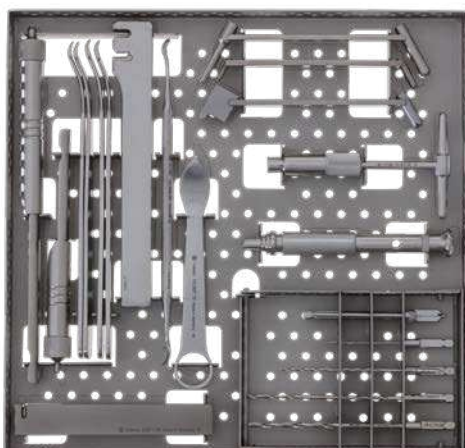

Set no. 19.140.00 Level 3



Set no. 19.140.00 Level 4

 Internal hexagon

Level 3

Item no.	Item description	Quant.
Instruments		
2.904.01	drill bit for quick coupling, Ø1.1x65, spiral length 15, double spiral	1
2.904.02	drill bit for quick coupling, Ø1.5x88, spiral length 25, double spiral	1
2.904.03	drill bit for quick coupling, Ø2x105, spiral length 30, double spiral	1
2.904.07	drill bit for quick coupling, Ø2.7x105, spiral length 50, double spiral	1
10.505.40	countersink for quick coupling, length 72, for screws Ø2.7 / Ø3.5 / Ø4.0	1
10.505.15	countersink for dental coupling, length 57, for screws Ø1.5 and Ø2.0	1
2.924.15	tap for dental coupling for cortical screws, Ø1.5x50	1
2.924.20	tap for dental coupling for cortical screws, Ø2x53	1
2.924.27	tap for quick coupling for cortical screws, Ø2.7x100	1
10.205.05	handle with dental coupling	1
10.305.05	T-handle with quick coupling, length 93.5	1
10.500.07	double drill guide, Ø1.1/Ø1.5	1
10.500.09	double drill guide, Ø2/Ø2.7	1
10.520.20	triple drill guide Ø2	1
2.953.15	gauge with clasp for screws Ø1.5 and Ø2, measuring range 40	1
2.953.27	gauge with clasp for screws Ø2.7, measuring range 70	1
10.508.00	sharp hook	1
2.911.04	bending device for plates for mini fragment 1.5 and 2.0	2
2.911.03	bending device for plates for mini fragment 2.0 and small fragment 3.5	1
10.507.06	bone lever, width 6, narrow	2
10.507.08	bone lever, width 8, narrow	2
10.507.15	bone lever, width 15, broad	1

Level 4

Item no.	Item description	Quant.
Instruments		
2.946.15	hex screwdriver with holding sleeve for screw Ø1.5	1
2.9406.25	hex screwdriver with handle for screws Ø2.7-Ø4.0, AF2.5, conical	1
10.428.01	bending forceps for mini plates 1.5 until 2.0	2
10.429.00	holding forceps for mini plates	1
10.425.135	repositioning forceps with teeth, length 135	1
10.421.01	extraction forceps for wires, flat	1
10.506.01	raspatory, breadth 3, extra narrow, arched, straight edge	1

Container

Item no.	Item description	Quant.
19.142.00	perforated autoclavable container with inset for instruments/implants mini fragment	1

Set Mini Fragment Standard

Implants and instruments; several levels; stainless steel; Set no. 19.140.00

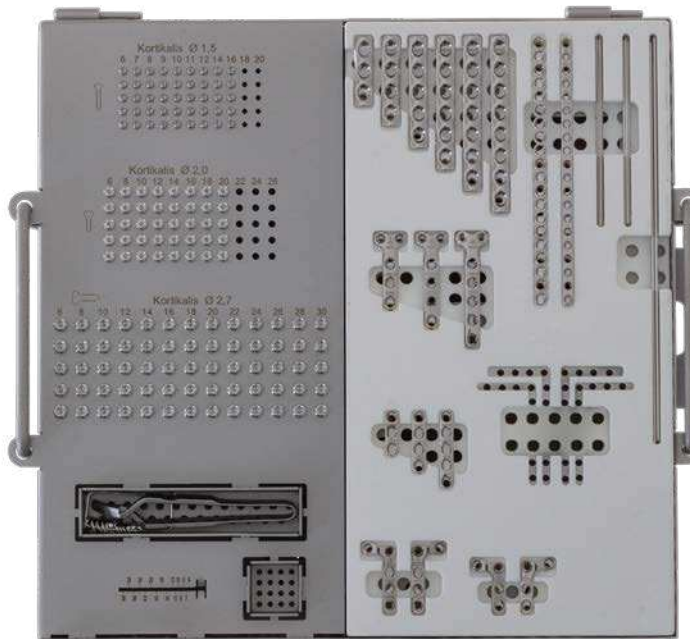

Set no. 19.140.00 Level 1



Set no. 19.140.00 Level 2

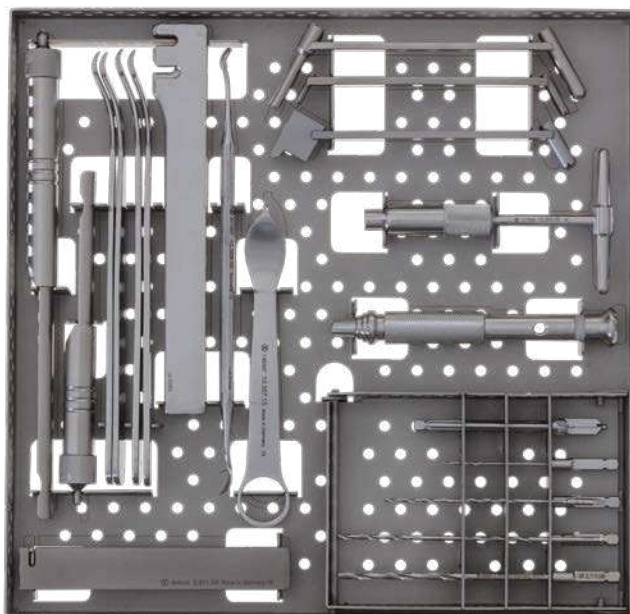

Set no. 19.140.00 Level 3



Set no. 19.140.00 Level 4

Small Fragment Set Standard - Straight Plates

for Instruments and Screws Ø 3.5 mm; Titanium; Set no. 19.535.00



Item no. 5.3133.06



Item no. 5.809.06



Item no. 5.823.06



Item no. 5.07803.07



Set no. 19.535.00

Item no.	Item description	Quant.
Implants - plates		
Reco-plate with conical thread Ø 3.5 mm straight; strong; variable angle-stable; titanium		
5.3133.05	5 holes; 58 x 10 mm	1
5.3133.06	6 holes; 70 x 10 mm	1
5.3133.07	7 holes; 82 x 10 mm	1
5.3133.08	8 holes; 94 x 10 mm	1
5.3133.09	9 holes; 106 x 10 mm	1
5.3133.10	10 holes; 118 x 10 mm	1
5.3133.12	12 holes; 142 x 10 mm	1

One third tubular plate with conical thread Ø 3.5 mm; titanium		
5.809.05	5 holes; 61 x 9.0 mm	1
5.809.06	6 holes; 73 x 9.0 mm	1
5.809.07	7 holes; 85 x 9.0 mm	1
5.809.08	8 holes; 97 x 9.0 mm	1
5.809.09	9 holes; 109 x 9.0 mm	1
5.809.10	10 holes; 121 x 9.0 mm	1
5.809.12	12 holes; 145 x 9.0 mm	1

Item no.	Item description	Quant.
Implants - plates		
Straight Platte with conical thread Ø 3.5 mm variable angle-stable; titanium		
5.823.05	5 holes; 64 x 11 mm	1
5.823.06	6 holes; 77 x 11 mm	1
5.823.07	7 holes; 90 x 11 mm	1
5.823.08	8 holes; 103 x 11 mm	1
5.823.09	9 holes; 116 x 11 mm	1
5.823.10	10 holes; 129 x 11 mm	1

Fibula plate with conical thread Ø 3.5 mm variable angle-stable; titanium		
5.07803.07	7 holes; 96 x 10 mm	1
5.07803.09	9 holes; 122 x 10 mm	1
5.07803.11	11 holes; 148 x 10 mm	1

Container		
19.534.00	perforated autoclavable container with inset for implants-modul straight plate	1

Small Fragment Set Standard - Straight Plates

for Instruments and Screws \varnothing 3.5 mm; Titanium; Set no. 19.535.00

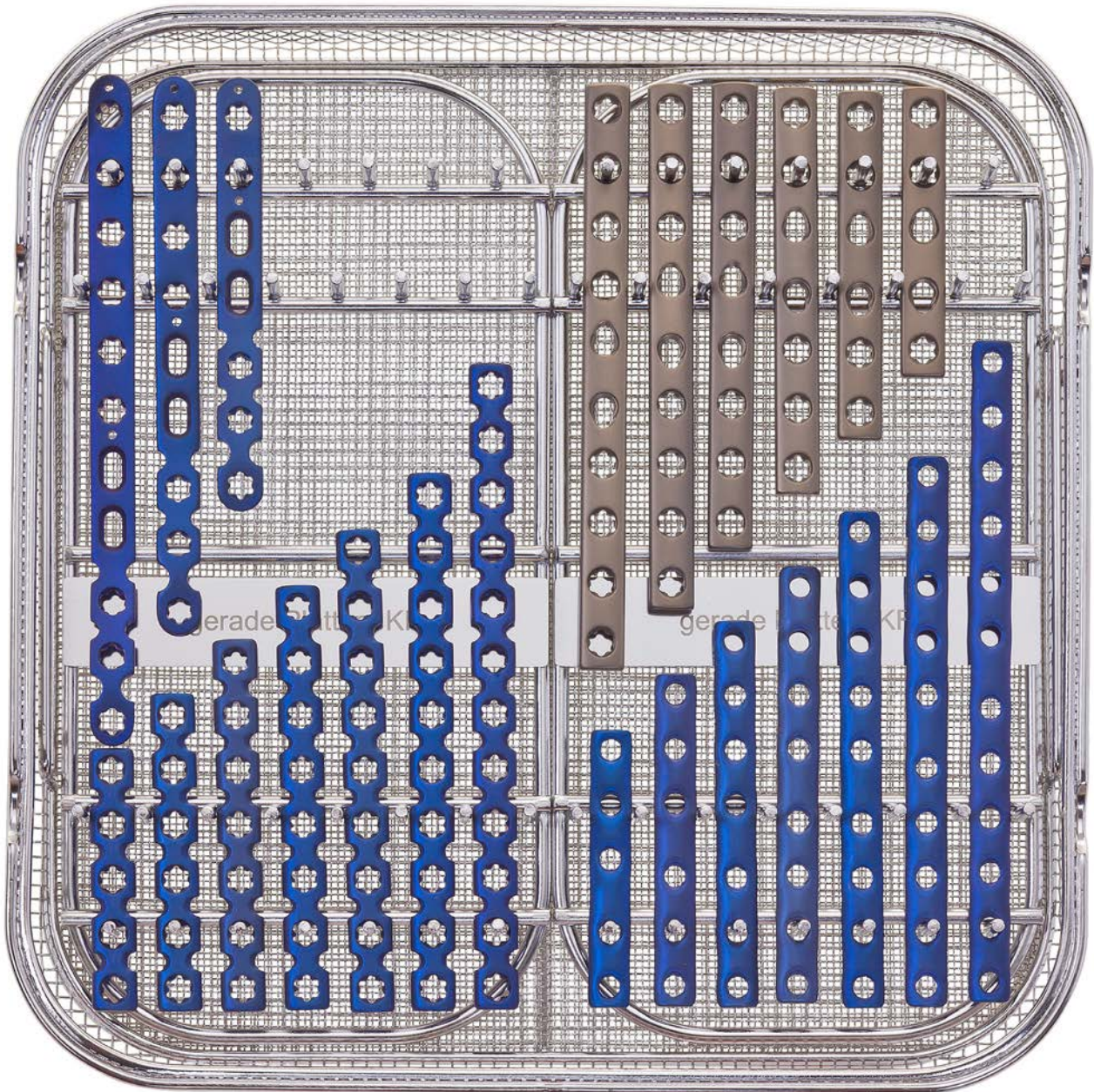

Set no. 19.535.00

Set Small Fragment Standard

Implants and instruments; several levels; Titanium; Set no. 19.467.00

LEVEL 1



Item no. 3.140.30



Item no. 3.132.30



Set no. 19.467.00 Level 1 Internal hexagon

Item no.	Item description	Quant.
Implants – screws		
	cancellous screw Ø 4.0 mm; partial thread; back tapping; Titanium	
3.140.10	Length 10 mm; Thread 5	3
3.140.12	Length 12 mm; Thread 5	3
3.140.14	Length 14 mm; Thread 5	3
3.140.16	Length 16 mm; Thread 6	3
3.140.18	Length 18 mm; Thread 7	3
3.140.20	Length 20 mm; Thread 8	3
3.140.22	Length 22 mm; Thread 9	3
3.140.24	Length 24 mm; Thread 10	3
3.140.26	Length 26 mm; Thread 12	3
3.140.28	Length 28 mm; Thread 14	3
3.140.30	Length 30 mm; Thread 14	3
3.140.32	Length 32 mm; Thread 14	3
3.140.34	Length 34 mm; Thread 14	3
3.140.35	Length 35 mm; Thread 14	3
3.140.36	Length 36 mm; Thread 14	3
3.140.38	Length 38 mm; Thread 14	3
3.140.40	Length 40 mm; Thread 14	3
3.140.45	Length 45 mm; Thread 15	3
3.140.50	Length 50 mm; Thread 15	3
3.140.55	Length 55 mm; Thread 16	3
3.140.60	Length 60 mm; Thread 16	3

Item no.	Item description	Quant.
Implants – screws		
	Cortical Screw Ø 3.5 mm; self tapping; full thread; Titanium	
3.132.10	Length 10 mm	8
3.132.12	Length 12 mm	8
3.132.14	Length 14 mm	8
3.132.16	Length 16 mm	8
3.132.18	Length 18 mm	8
3.132.20	Length 20 mm	8
3.132.22	Length 22 mm	8
3.132.24	Length 24 mm	8
3.132.26	Length 26 mm	8
3.132.28	Length 28 mm	8
3.132.30	Length 30 mm	8
3.132.32	Length 32 mm	8
3.132.34	Length 34 mm	8
3.132.36	Length 36 mm	8
3.132.38	Length 38 mm	8
3.132.40	Length 40 mm	8
3.132.45	Length 45 mm	5
3.132.50	Length 50 mm	4
3.132.55	Length 55 mm	4
3.132.60	Length 60 mm	4

Set Small Fragment Standard

Implants and instruments; several levels; Titanium; Set no. 19.467.00

LEVEL 1



Item no. 3.145.30



Item no. 2.954.01



Set no. 19.467.00 Level 1 Internal hexagon

Item no.	Item description	Quant.
Instruments		
2.904.05	drill bit for quick coupling, Ø2.5x105, spiral length 50, double spiral	2
2.904.10	drill bit for quick coupling, Ø3.5x110, spiral length 40, double spiral	1
10.505.40	countersink for quick coupling, length 72, for screws Ø2.7 / Ø3.5 / Ø4.0	1
10.305.05	T-handle with quick coupling, length 93.5	1
10.520.30	double drill guide Ø2.5/Ø3.5, spring bushing	1
10.510.35	inserting drill guide, Ø3.5/2.5	1
2.9406.25	hex screwdriver with handle for screws Ø2.7-Ø4.0, AF2.5, conical	1
2.941.25A	hex screwdriver inset f.quick coupling f.screw Ø2.7-Ø4.0, wrench width 2.5, conic	1
2.954.35A	holding sleeve for screws Ø3.5 and Ø4.0	1
2.953.27	gauge with clasp for screws Ø2.7, measuring range 70	1
10.508.00	sharp hook	1
2.954.01	screw forceps, self holding	1
10.500.04	drill guide for neutral and compression position, Ø2.5	1
10.520.20	triple drill guide Ø2	1
10.506.00	raspatory, breadth 6, narrow, arched, straight edge	1

Item no.	Item description	Quant.
Implants – screws		
cancellous screw Ø 4.0 mm; full thread; Titanium		
Internal hexagon		
3.145.10	Length 10 mm	3
3.145.12	Length 12 mm	3
3.145.14	Length 14 mm	3
3.145.16	Length 16 mm	3
3.145.18	Length 18 mm	3
3.145.20	Length 20 mm	3
3.145.22	Length 22 mm	3
3.145.24	Length 24 mm	3
3.145.26	Length 26 mm	3
3.145.28	Length 28 mm	3
3.145.30	Length 30 mm	3
3.145.32	Length 32 mm	3
3.145.34	Length 34 mm	3
3.145.35	Length 35 mm	3
3.145.36	Length 36 mm	3
3.145.38	Length 38 mm	3
3.145.40	Length 40 mm	3
3.145.45	Length 45 mm	3
3.145.50	Length 50 mm	3
3.145.55	Length 55 mm	3
3.145.60	Length 60 mm	3

Set Small Fragment Standard

Implants and instruments; several levels; Titanium; Set no.19.467.00

LEVEL 2



Item no. 5.313.06



Item no. 5.812.33



Item no. 5.863.01



Item no. 5.817.33

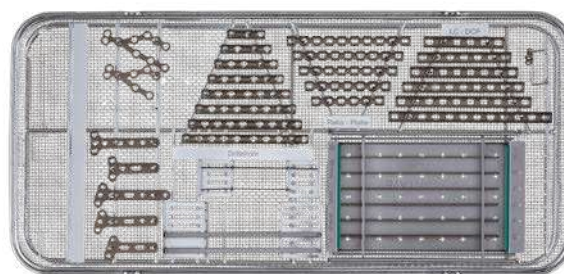

Set no. 19.467.00 Level 2

Item no.	Item description	Quant.
Implants – plates		
5.220.06	low-contact plate 3.5 and 4.0, 6 holes, 77x11	1
5.220.07	low-contact plate 3.5 and 4.0, 7 holes, 90x11	1
5.220.08	low-contact plate 3.5 and 4.0, 8 holes, 103x11	1
5.220.09	low-contact plate 3.5 and 4.0, 9 holes, 116x11	1
5.220.10	low-contact plate 3.5 and 4.0, 10 holes, 129x11	1
5.220.12	low-contact plate 3.5 and 4.0, 12 holes, 155x11	1
5.313.06	reco-plate 3.5, 6 holes, 70x10, straight, strong	1
5.313.07	reco-plate 3.5, 7 holes, 82x10, straight, strong	1
5.313.08	reco-plate 3.5, 8 holes, 94x10, straight, strong	1
5.313.09	reco-plate 3.5, 9 holes, 106x10, straight, strong	1
5.313.10	reco-plate 3.5, 10 holes, 118x10, straight, strong	1
5.808.03	one third tubular plate with collar 3.5, 3 holes, 37x9	1
5.808.04	one third tubular plate with collar 3.5, 4 holes, 49x9	1
5.808.05	one third tubular plate with collar 3.5, 5 holes, 61x9	1
5.808.06	one third tubular plate with collar 3.5, 6 holes, 73x9	1
5.808.07	one third tubular plate with collar 3.5, 7 holes, 85x9	1
5.808.08	one third tubular plate with collar 3.5, 8 holes, 97x9	1
5.808.09	one third tubular plate with collar 3.5, 9 holes, 109x9	1
5.808.10	one third tubular plate with collar 3.5, 10 holes, 121x9	1
5.812.33	T-plate 3.5/3.5, 3/3 holes, 52x10, oblique, 2 long hole in shank	1
5.812.34	T-plate 3.5/3.5, 3/4 holes, 63x10, oblique, 2 long hole in shank	1
5.812.35	T-plate 3.5/3.5, 3/5 holes, 74x10, oblique, 2 long hole in shank	1
5.817.33	T-plate 3.5/3.5, 3/3 holes, 50x10, rectangular	1
5.817.35	T-plate 3.5/3.5, 3/5 holes, 67x10, rectangular	1
5.862.01	calcaneus plate 3.5, 10 holes, length 73, big	1
5.863.01	calcaneus plate 3.5, 8 holes, length 55, small	1
3.200.02	washer, outside Ø7 / inside Ø3.8	5

Item no.	Item description	Quant.
Wires		
7.031.10	Kirschner wire with trocar point and round end, Ø1x150, ti	5
7.031.12	Kirschner wire with trocar point and round end, Ø1.2x150, ti	5
7.031.14	Kirschner wire with trocar point and round end, Ø1.4x150, ti	5
7.031.16	Kirschner wire with trocar point and round end, Ø1.6x150, ti	5
7.031.18	Kirschner wire with trocar point and round end, Ø1.8x150, ti	5
7.031.20	Kirschner wire with trocar point and round end, Ø2x150, ti	5

Item no.	Item description	Quant.
Instruments		
2.911.03	bending device for plates for mini fragment 2.0 and small fragment 3.5	1
10.450.07	bending model for small fragment-plates, 7 holes, 85x10	1
10.450.09	bending model for small fragment-plates, 9 holes, 110x10	1
20.502.00	holding clamp, big	1

Item no.	Item description	Quant.
Container		
20.150.20	sorting bank, 160x105x26, for wires Ø1.0 to Ø2.0, Ln 150	1

Set Small Fragment Standard

Implants and instruments; several levels; Titanium; Set no. 19.467.00

LEVEL 3



Item no. 10.421.01

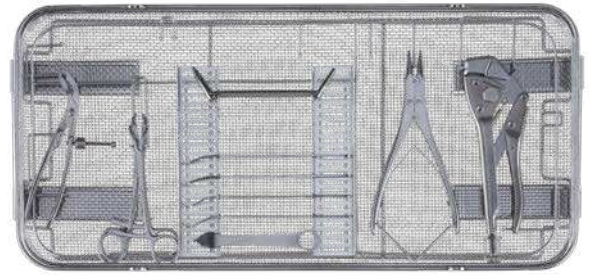

Set no. 19.467.00 Level 3

Item no.	Item description	Quant.
Instruments		
10.421.02	extraction forceps for wires, round	1
10.507.08	bone lever, width 8, narrow	2
10.507.15	bone lever, width 15, broad	1
10.428.03	bending forceps for mini plates 2.7 until 3.5	1
10.427.00	bone holding forceps, length 150, self-balancing	1
10.507.06	bone lever, width 6, narrow	2
10.425.135	repositioning forceps with teeth, length 135	1
10.425.145	repositioning forceps with block, length 145, serrated	1
10.520.35	double drill guide Ø2.5/Ø3.5	1

Item no.	Item description	Quant.
Container		
19.462.00/1	perforated autoclavable container with inset f. instruments/implants small fragm.	1

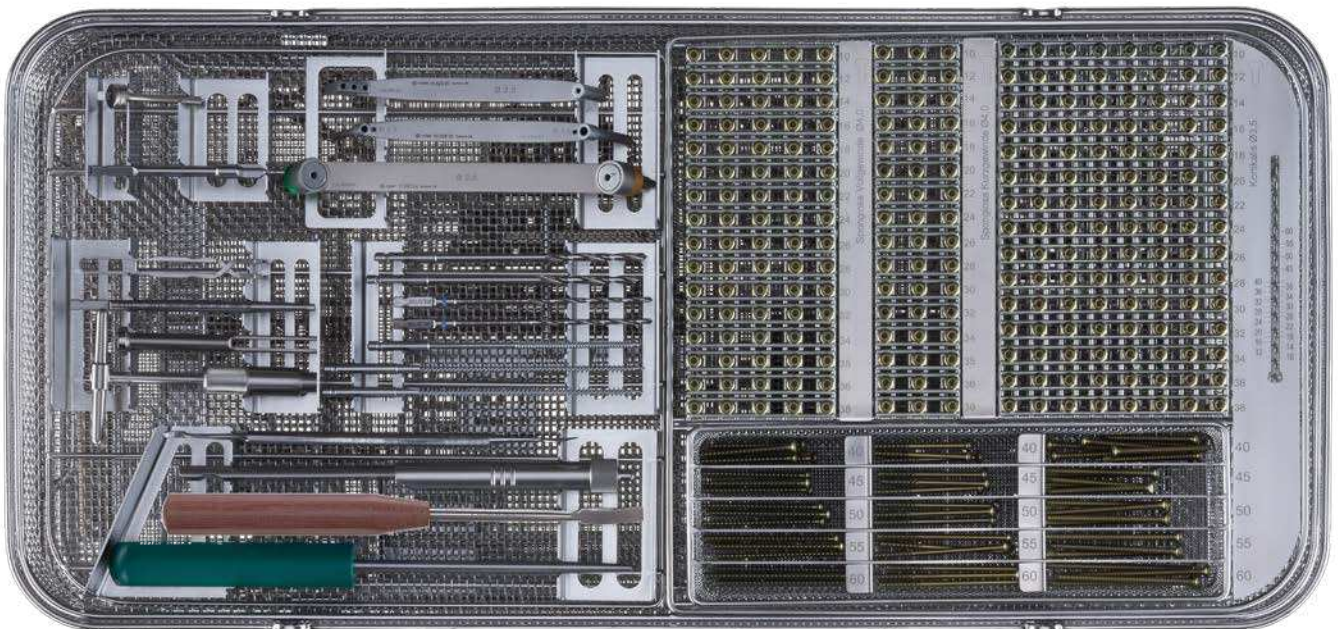

Set no. 19.467.00 complete



Königsee Implantate GmbH
OT Aschau | Am Sand 4
07426 Allendorf | Germany

Fon +49 36738 498-560
Fax +49 36738 498-569

Mail export@koenigsee-implantate.de

For further information please visit:
www.koenigsee-implantate.com

AnSp | Edition 02 | 2020-07
All pictured products are CE compliant.

Modul Standard Kleinfragment - KFI

für KFI-Implantate und Instrumente - Stahl, selbstschneidend - Komplettsset-Nr. 19.466.00

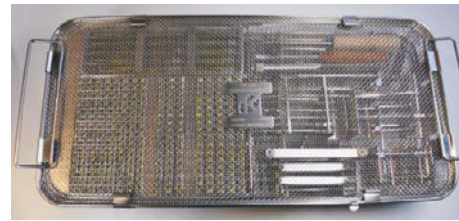

Bestell-Nr.
Komplettsset
Stahl:

19.466.00

EBENE 1

Schrauben

Kortikalisschrauben D 3,5, selbstschneidend

Bezeichnung	Bestell-Nr.	Anzahl
Kortikalisschraube; D 3,5 x 10; VG;ss;S	2.132.10	8
Kortikalisschraube; D 3,5 x 12; VG;ss;S	2.132.12	8
Kortikalisschraube; D 3,5 x 14; VG;ss;S	2.132.14	8
Kortikalisschraube; D 3,5 x 16; VG;ss;S	2.132.16	8
Kortikalisschraube; D 3,5 x 18; VG;ss;S	2.132.18	8
Kortikalisschraube; D 3,5 x 20; VG;ss;S	2.132.20	8
Kortikalisschraube; D 3,5 x 22; VG;ss;S	2.132.22	8
Kortikalisschraube; D 3,5 x 24; VG;ss;S	2.132.24	8
Kortikalisschraube; D 3,5 x 26; VG;ss;S	2.132.26	8
Kortikalisschraube; D 3,5 x 28; VG;ss;S	2.132.28	8
Kortikalisschraube; D 3,5 x 30; VG;ss;S	2.132.30	8
Kortikalisschraube; D 3,5 x 32; VG;ss;S	2.132.32	8
Kortikalisschraube; D 3,5 x 34; VG;ss;S	2.132.34	8
Kortikalisschraube; D 3,5 x 36; VG;ss;S	2.132.36	8
Kortikalisschraube; D 3,5 x 38; VG;ss;S	2.132.38	8
Kortikalisschraube; D 3,5 x 40; VG;ss;S	2.132.40	8
Kortikalisschraube; D 3,5 x 45; VG;ss;S	2.132.45	4
Kortikalisschraube; D 3,5 x 50; VG;ss;S	2.132.50	4
Kortikalisschraube; D 3,5 x 55; VG;ss;S	2.132.55	4
Kortikalisschraube; D 3,5 x 60; VG;ss;S	2.132.60	4

Schrauben

Spongiaschrauben D 4,0; Teilgewinde, rückschneidend

Bezeichnung	Bestell-Nr.	Anzahl
Spongiaschraube; D 4 x 10; Gew.5;rs;S	2.140.10	3
Spongiaschraube; D 4 x 12; Gew.5;rs;S	2.140.12	3
Spongiaschraube; D 4 x 14; Gew.5;rs;S	2.140.14	3
Spongiaschraube; D 4 x 16; Gew.6;rs;S	2.140.16	3
Spongiaschraube; D 4 x 18; Gew.7;rs;S	2.140.18	3
Spongiaschraube; D 4 x 20; Gew.8;rs;S	2.140.20	3
Spongiaschraube; D 4 x 22; Gew.9;rs;S	2.140.22	3
Spongiaschraube; D 4 x 24; Gew.10;rs;S	2.140.24	3
Spongiaschraube; D 4 x 26; Gew.12;rs;S	2.140.26	3
Spongiaschraube; D 4 x 28; Gew.14;rs;S	2.140.28	3
Spongiaschraube; D 4 x 30; Gew.14;rs;S	2.140.30	3
Spongiaschraube; D 4 x 32; Gew.14;rs;S	2.140.32	3
Spongiaschraube; D 4 x 34; Gew.14;rs;S	2.140.34	3
Spongiaschraube; D 4 x 36; Gew.14;rs;S	2.140.36	3
Spongiaschraube; D 4 x 38; Gew.14;rs;S	2.140.38	3
Spongiaschraube; D 4 x 40; Gew.14;rs;S	2.140.40	3
Spongiaschraube; D 4 x 45; Gew.15;rs;S	2.140.45	3
Spongiaschraube; D 4 x 50; Gew.15;rs;S	2.140.50	3
Spongiaschraube; D 4 x 55; Gew.16;rs;S	2.140.55	3
Spongiaschraube; D 4 x 60; Gew.16;rs;S	2.140.60	3

Schrauben

Spongiaschrauben D 4,0; Vollgewinde

Bezeichnung	Bestell-Nr.	Anzahl
Spongiaschraube; D 4 x 10; VG; S	2.145.10	5
Spongiaschraube; D 4 x 12; VG; S	2.145.12	5
Spongiaschraube; D 4 x 14; VG; S	2.145.14	5
Spongiaschraube; D 4 x 16; VG; S	2.145.16	5
Spongiaschraube; D 4 x 18; VG; S	2.145.18	5
Spongiaschraube; D 4 x 20; VG; S	2.145.20	5
Spongiaschraube; D 4 x 22; VG; S	2.145.22	5
Spongiaschraube; D 4 x 24; VG; S	2.145.24	5
Spongiaschraube; D 4 x 26; VG; S	2.145.26	5
Spongiaschraube; D 4 x 28; VG; S	2.145.28	5
Spongiaschraube; D 4 x 30; VG; S	2.145.30	5
Spongiaschraube; D 4 x 32; VG; S	2.145.32	5
Spongiaschraube; D 4 x 34; VG; S	2.145.34	5
Spongiaschraube; D 4 x 35; VG; S	2.145.35	5
Spongiaschraube; D 4 x 36; VG; S	2.145.36	5
Spongiaschraube; D 4 x 38; VG; S	2.145.38	5
Spongiaschraube; D 4 x 40; VG; S	2.145.40	5
Spongiaschraube; D 4 x 45; VG; S	2.145.45	3
Spongiaschraube; D 4 x 50; VG; S	2.145.50	3
Spongiaschraube; D 4 x 55; VG; S	2.145.55	3
Spongiaschraube; D 4 x 60; VG; S	2.145.60	3

Instrumente

Bezeichnung	Bestell-Nr.	Anzahl
Unterlegscheibe; AØ 7/1Ø 3,8; S	2.200.02	5
Spiralbohrer f.SK, Ø3;5x105;Spl50;2-lippig	2.904.05	2
Spiralbohrer f.SK, Ø3;5x110;Spl40;2-lippig	2.904.10	2
Kopfraumfräser f.SK, L72mm,f. Schr. D 2,7 - 4,0	10.505.40	1
Gewindebohrer f.SK f.Kortikalisschrauben Ø 3,5 x 110	2.924.35	1
Gewindebohrer f.SK f.Spongiaschrauben,Ø4x130	2.927.40	2
T-Griffstück m.SK; Ln 93,5	10.305.05	1
Doppelbohrbuchse m.Feder; Ø2,5/Ø3,5	10.520.30	1
Doppelbohrbuchse; Ø2,5/Ø3,5	10.520.35	1
Steckbohrbuchse; Ø3,5/Ø2,5	10.510.35	1
Sechskantschraubendreher m.Griff f.Ø2,7-4,0;SW 2,5;kan.	2.940.25SA	1
Sechskantschraubendrehereinsatz f.SK f.Ø2,7,4,0;SW 2,5	2.941.25A	1
Haltehülse f.Schrauben Ø3,5 u.Ø4,0	2.954.35A	1
Messgerät m.Haken f.Schrauben Ø2,7;MB 70	2.953.27	1
Scharfer Haken	10.508.00	1
Selbsthaltende Schraubenpinzette	2.954.01	1
Bohrbuchse f.Neutral-u.Kompressionsstellung; Ø2,5	10.500.04	1
Dreifach-Zielbohrbuchse; Ø2	10.520.20	1

Modul Standard Kleinfragment - KFI

für KFI-Implantate und Instrumente - Stahl, selbstschneidend - Komplettsset-Nr. 19.466.00

EBENE 2

Platten

Bezeichnung	Bestell-Nr.	Anzahl
Low-Contact-Platte 3.5 und 4.0; 6L; 77x10; S	4.220.06	1
Low-Contact-Platte 3.5 und 4.0; 7L; 90x10; S	4.220.07	1
Low-Contact-Platte 3.5 und 4.0; 8L; 103x10; S	4.220.08	1
Low-Contact-Platte 3.5 und 4.0; 9L; 116x10; S	4.220.09	1
Low-Contact-Platte 3.5 und 4.0; 10L; 129x10; S	4.220.10	1
Low-Contact-Platte 3.5 und 4.0; 12L; 155x10; S	4.220.12	1
Reko-Platte 3.5; 6L; 70x10; gerade, stark; S	4.313.06	1
Reko-Platte 3.5; 7L; 82x10; gerade, stark; S	4.313.07	1
Reko-Platte 3.5; 8L; 94x10; gerade, stark; S	4.313.08	1
Reko-Platte 3.5; 9L; 106x10; gerade, stark; S	4.313.09	1
Reko-Platte 3.5; 10L; 118x10; gerade, stark; S	4.313.10	1
Halswirbelplatte 3.5; 11L; 59x19; Teilung 16+18+18; S	4.560.06	0
Kleeblattplatte 3.5; 3L; 88x15; S	5.730.03	0
Kleeblattplatte 3.5; 4L; 104x15; S	5.730.04	0
Drittelrohrplatte m. Wulst 3.5; 3L; 37x9; S	4.808.03	1
Drittelrohrplatte m. Wulst 3.5; 4L; 49x9; S	4.808.04	1
Drittelrohrplatte m. Wulst 3.5; 5L; 61x9; S	4.808.05	1
Drittelrohrplatte m. Wulst 3.5; 6L; 73x9; S	4.808.06	1
Drittelrohrplatte m. Wulst 3.5; 7L; 85x9; S	4.808.07	1
Drittelrohrplatte m. Wulst 3.5; 8L; 97x9; S	4.808.08	1
Drittelrohrplatte m. Wulst 3.5; 9L; 109x9; S	4.808.09	1
Drittelrohrplatte m. Wulst 3.5; 10L; 121x9; S	4.808.10	1
T-Platte 3.5/3.5; 3/3L; 52x10; schrägwi., 2 LL im Schaft; S	4.812.33	2
T-Platte 3.5/3.5; 3/4L; 63x10; schrägwi., 2 LL im Schaft; S	4.812.34	2
T-Platte 3.5/3.5; 3/5L; 74x10; schrägwi., 2 LL im Schaft; S	4.812.35	2
T-Platte 3.5/3.5; 3/3L; 50x10; rechteckig; S	4.817.33	2
T-Platte 3.5/3.5; 3/5L; 67x10; rechteckig; S	4.817.35	2
Fersenbeinplatte 3.5; 10L; Ln 73; groß; S	4.862.01	1
Fersenbeinplatte 3.5; 8L; Ln 55; klein; S	4.863.01	1

Kirschnerdrähte

Bezeichnung	Bestell-Nr.	Anzahl
Kirschnerdraht m. Trokarsp.u.rd.Ende; Ø1x150; S	6.031.10	5
Kirschnerdraht m. Trokarsp.u.rd.Ende; Ø1,2x150; S	6.031.12	5
Kirschnerdraht m. Trokarsp.u.rd.Ende; Ø1,4x150; S	6.031.14	5
Kirschnerdraht m. Trokarsp.u.rd.Ende; Ø1,6x150; S	6.031.16	5
Kirschnerdraht m. Trokarsp.u.rd.Ende; Ø1,8x150; S	6.031.18	5
Kirschnerdraht m. Trokarsp.u.rd.Ende; Ø2x150; S	6.031.20	5
Sortiergestell; 160x105x26; f.Drähte Ø1,0-Ø2,0; Ln 150	20.150.20	1

Instrumente

Bezeichnung	Bestell-Nr.	Anzahl
Biegeisen f. Platten f. MF 2.7 u. KF 3.5 (Paar)	2.911.03	1
Biegeschablone f. KF-Platten; 7L; 85x10	10.450.07	1
Biegeschablone f. KF-Platten; 9L; 110x10	10.450.09	1
Halteklammer, 30 x 16 (für Unterlegscheiben)	20.502.00	2

EBENE 3

Instrumente

Bezeichnung	Bestell-Nr.	Anzahl
Extraktionszange f.Drähte;rund	10.421.02	1
Knochenheber; B 8; schmal	10.507.08	2
Knochenheber; B 15; breit	10.507.15	1
Biegezange f.Platten 2.7-3.5	10.428.03	1
Knochenhaltezange; Ln 150; selbstzentrierend	10.427.00	1
Knochenheber; B 6; schmal	10.507.06	2
Elevatorium; Breite 6; schmal, gebogen, gerade Schneide	10.506.00	1
Repositionszange m.Spitzen; Ln 135	10.425.135	1
Repositionszange m.Sperre; Ln 145; gezahnt	10.425.145	1
Siebkorb m.Einsatz f.Instrumente/Implantate KF	19.462.00/1	1

OP set module instruments

for small fragment implants, complete set item no. 19.531.00

item designation	item no.	quant.
instruments		
hex screwdriver with handle for screws Ø 2.7 - Ø 4.0, AF2.5, conical	2.9406.25	1
drill bit for quick coupling, Ø 2.5 x 105, spiral length 50, double spiral	2.904.05	1
drill bit for quick coupling, Ø 3.5 x 110, spiral length 40, double spiral	2.904.10	1
drill bit for quick coupling, Ø 2.5 x 155, spiral length 60, double spiral	2.904.22	1
tap for quick coupling for cortical screws, Ø 3.5 x 110	2.924.35	1
tap for quick coupling for cancellous screws, Ø 4 x 130	2.927.40	1
drill guide with handle for small fragment, handle length 55 mm	10.500.27A	1
double drill guide Ø 2.5/Ø 3.5, spring bushing	10.520.30	1
Kirschner wire with trocar point and round end, Ø 1.6 x 150, st.st.	6.031.16	5
T-handle with quick coupling, length 93.5	10.305.05	1
<u>optional:</u>		
torque screwdriver handle, 2.2 newton meter	2.934.25	1
hex screwdriver inset for quick coupling for screws Ø 2.7 - Ø 4.0, wrench width 2.5, conical	2.941.25A	1

item designation	item no.	quant.
Extension of instruments for bone plates		
drill guide for angle stable screwing, length 45, small fragment	2.977.01	2
drill guide w.handle for variable angle stable screwing, small fragment, length 45	2.977.08	1
drill guide for angle stable compression hole, SF	2.9771.35	1
gauge w. clasp for screws w. conical head thread Ø 3.5, Ø 4.0, measuring range 60	2.953.60	1
bending lever for reco plates small fragment	2.911.06	2
<u>optional:</u>		
bending model for small fragment plates, 7 holes, 85 x 10 mm	10.450.07	1
bending model for small fragment plates, 9 holes; 110 x 10 mm	10.450.09	1

Extension of instruments for joint plates		
drill guide for angle stable screwing, length 68, small fragment	2.977.04	2
drill guide w.handle for variable angle stable screwing, length 68, small fragment	2.977.09	1
gauge w. clasp for screws w. conical head thread Ø 3.5, Ø 4.0, measuring range 70	2.953.70	1
guide block for proximal small fragment humerus plates, 8 holes in head, flat	10.179.10	1
sleeve for guide block for proximal small fragment humerus plates	10.173.01	2
screw driver for guide block	10.173.05	1

electively for implants proximal humerus plates with 5 holes		
guide block for proximal small fragment humerus plates with 5 head holes	10.173.00	1

Container		
perforated autoclavable container with inset for instruments - module small fragment	19.530.00	1



Komplett-Set Art.-Nr. 19.531.00

OP set module instruments

for small fragment implants, complete set item no. 19.531.00

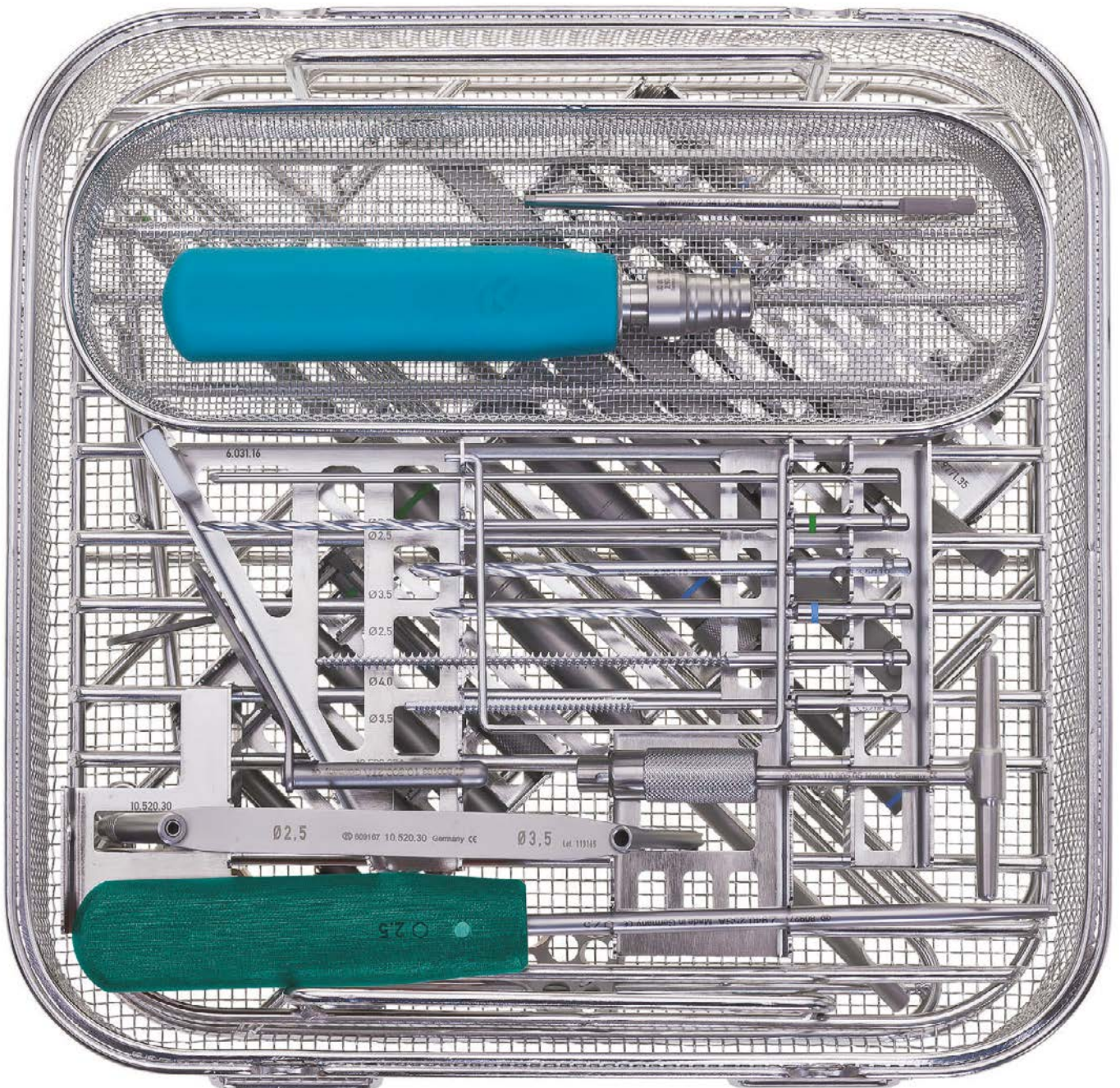

Combined Set 2.7/3.5; Screws and Instruments

variable angle-stable; titanium; set no. 19.671.00



Item no. 3.125.30



Item no. 3.136.30



Item no. 3.128.18



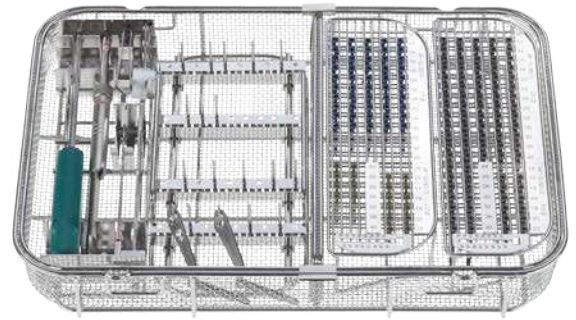

Item no. 3.138.30





Item no. 19.671.00

Internal hexagon

Item no.	Item description	Quant.
Implants - screws		
Cortical screws Ø 2.7 mm; head 5.0; conical headthread; fully threaded; self tapping; titanium		 Internal hexagon
3.125.12	length 12 mm	5
3.125.14	length 14 mm	5
3.125.16	length 16 mm	5
3.125.18	length 18 mm	5
3.125.20	length 20 mm	5
3.125.22	length 22 mm	5
3.125.24	length 24 mm	5
3.125.26	length 26 mm	5
3.125.28	length 28 mm	5
3.125.30	length 30 mm	5

Item no.	Item description	Quant.
Implants - screws		
Cortical screws Ø 3.5 mm; head 5.0; conical headthread; fully threaded; self tapping; titanium		 Internal hexagon
3.136.12	length 12 mm	5
3.136.14	length 14 mm	5
3.136.16	length 16 mm	5
3.136.18	length 18 mm	5
3.136.20	length 20 mm	5
3.136.22	length 22 mm	5
3.136.24	length 24 mm	5
3.136.26	length 26 mm	5
3.136.28	length 28 mm	5
3.136.30	length 30 mm	5
3.136.32	length 32 mm	5
3.136.36	length 36 mm	5
3.136.40	length 40 mm	5

Cortical screws Ø 2.7 mm; fully threaded; self tapping; flacher head; titanium		 Internal hexagon
3.128.12	length 12 mm	2
3.128.14	length 14 mm	2
3.128.16	length 16 mm	2
3.128.18	length 18 mm	2
3.128.20	length 20 mm	2
3.128.22	length 22 mm	2
3.128.24	length 24 mm	2
3.128.26	length 26 mm	2
3.128.28	length 28 mm	2
3.128.30	length 30 mm	2

Cortical screws Ø 3.5 mm; head 5.0 fully threaded; self tapping; titanium		 Internal hexagon
3.138.12	length 12 mm	2
3.138.14	length 14 mm	2
3.138.16	length 16 mm	2
3.138.18	length 18 mm	2
3.138.20	length 20 mm	2
3.138.22	length 22 mm	2
3.138.24	length 24 mm	2
3.138.26	length 26 mm	2
3.138.28	length 28 mm	2
3.138.30	length 30 mm	2
3.138.32	length 32 mm	2
3.138.36	length 36 mm	2
3.138.40	length 40 mm	2

Combined Set 2.7/3.5; Screws and Instruments

variable angle-stable; titanium; set no. 19.671.00

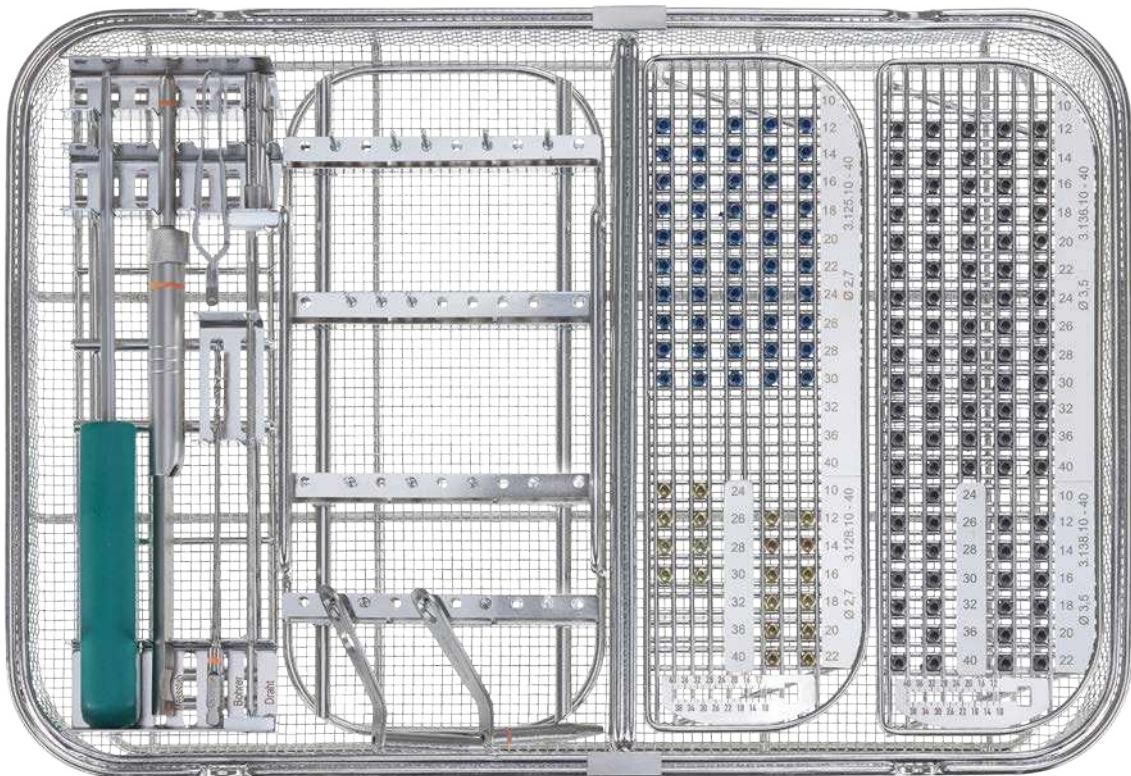

Item no. 19.671.00

 Internal hexagon

Item no.	Item description	Quant.
Instruments		
2.9406.25	hex screwdriver with handle for screws Ø 2.7 mm - Ø 4.0 mm; AF 2.5; conical	1
2.977.10	drill guide with handle for variable angle-stable screwing; mini fragment; length 45 mm	1
2.977.11	drill guide for variable angle-stable screwing 2.7; length 44 mm	2
2.977.12	drill guide with handle for variable angle-stable screwing; with head Ø 5.0 mm	1
2.977.13	drill guide for variable angle-stable screwing 3.5; with head Ø 5.0 mm; length 44 mm	2
2.904.04	drill bit for quick coupling; Ø 2.0 mm x 125 mm; spiral length 30 mm; double spiral	1
2.904.06	drill bit for quick coupling; Ø 2.5 mm x 125 mm; spiral length 60 mm; double spiral	1
2.953.65	gauge with clasp for screws Ø 2.7 mm; measuring range 60 mm	1
2.954.01	screw forceps; self holding	1

Item no.	Item description	Quant.
Wire		
6.031.10	Kirschner wire with trocar point; round end; Ø 1.0 mm x 150 mm; stainless steel	5

Container		
19.670.00	perforated autoclavable container with inset for instruments and implants for combined set 2.7/3.5; variable angle-stable	1

OP-set combined 3.5/4.5

with instruments and screws, titanium, set item no. 19.675.00

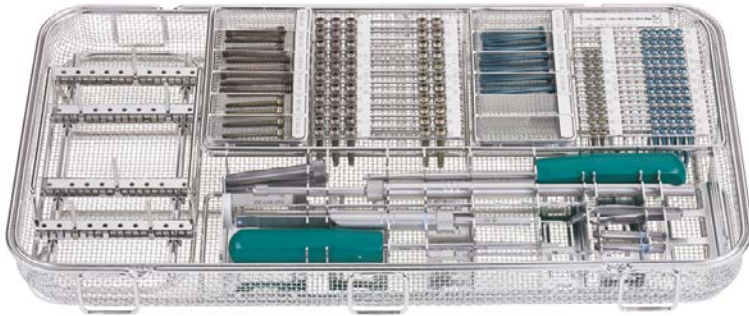

item no. complete set 19.675.00

Item description	Item no.	quantity
Instruments for small fragment		
hex screwdriver with handle for screws Ø 2.7 - Ø 4.0, AF 2.5, conical	2.9406.25	1
gauge with clasp for screws with conical head thread Ø 3.5, Ø 4.0 measuring range 60	2.953.60	1
drill bit for quick coupling, Ø 2.5 x 125, spiral length 60, double spiral	2.904.06	1
drill guide for angle stable screwing, length 45, small fragment	2.977.01	2

Instruments for large fragment		
hex screwdriver with handle for screws Ø 4.5 - Ø 7.0, AF 3.5, length 215	2.9406.35	1
gauge with clasp for screws with conical head thread Ø 4.5, Ø 6.0, measuring range 90	2.953.90	1
drill bit for quick coupling, Ø 3.2 x 195, spiral length 60, double spiral	2.904.09	1
drill guide for angle stable screwing, length 70, large fragment	2.977.02	2

Container		
perforated autoclavable container with inset for instruments and implants combined-set 3.5/4.5	19.674.00	1

Wire		
Kirschner wire with trocar point and round end, Ø 2.0 x 150, st.st.	6.031.20	1

Item description	Item no.	quantity
Instruments for large fragment and small fragment		
screw forceps, self holding	2.954.01	1

Item description	Item no.	quantity
Angle-stable cortical screws - small fragment		
fully threaded, self tapping, titanium Ø 3.5 mm		



length 20 mm	3.133.20	5
length 22 mm	3.133.22	5
length 24 mm	3.133.24	5
length 26 mm	3.133.26	5
length 28 mm	3.133.28	5
length 30 mm	3.133.30	5
length 32 mm	3.133.32	5
length 34 mm	3.133.34	5
length 36 mm	3.133.36	5
length 38 mm	3.133.38	5
length 40 mm	3.133.40	5
length 42 mm	3.133.42	5
length 45 mm	3.133.45	5
length 48 mm	3.133.48	5
length 50 mm	3.133.50	5

Item description	Item no.	quantity
Cortical screws - small fragment		
fully threaded, self tapping, titanium Ø 3.5 mm		



length 24 mm	3.132.24	2
length 26 mm	3.132.26	2
length 28 mm	3.132.28	2
length 30 mm	3.132.30	2
length 32 mm	3.132.32	2
length 34 mm	3.132.34	2
length 36 mm	3.132.36	2
length 38 mm	3.132.38	2
length 40 mm	3.132.40	2

OP-set combined 3.5/4.5

with instruments and screws, titanium, set item no. 19.675.00

Item description	Item no.	quantity
Cortical screws - large fragment		
fully threaded, self tapping, titanium Ø 4.5 mm		
		
length 18 mm	3.152.18	2
length 20 mm	3.152.20	2
length 22 mm	3.152.22	2
length 24 mm	3.152.24	2
length 26 mm	3.152.26	2
length 28 mm	3.152.28	2
length 30 mm	3.152.30	2
length 32 mm	3.152.32	2
length 34 mm	3.152.34	2
length 36 mm	3.152.36	2
length 38 mm	3.152.38	2
length 40 mm	3.152.40	2
length 42 mm	3.152.42	2

Item description	Item no.	quantity
Angle-stable cortical screws large fragment		
fully threaded, self tapping, titanium Ø 4.5 mm		
		
length 18 mm	3.545.18	3
length 20 mm	3.545.20	3
length 22 mm	3.545.22	3
length 24 mm	3.545.24	3
length 26 mm	3.545.26	3
length 28 mm	3.545.28	3
length 30 mm	3.545.30	3
length 32 mm	3.545.32	3
length 34 mm	3.545.34	3
length 36 mm	3.545.36	3
length 38 mm	3.545.38	3
length 40 mm	3.545.40	3
length 42 mm	3.545.42	3
length 45 mm	3.545.45	3
length 50 mm	3.545.50	3

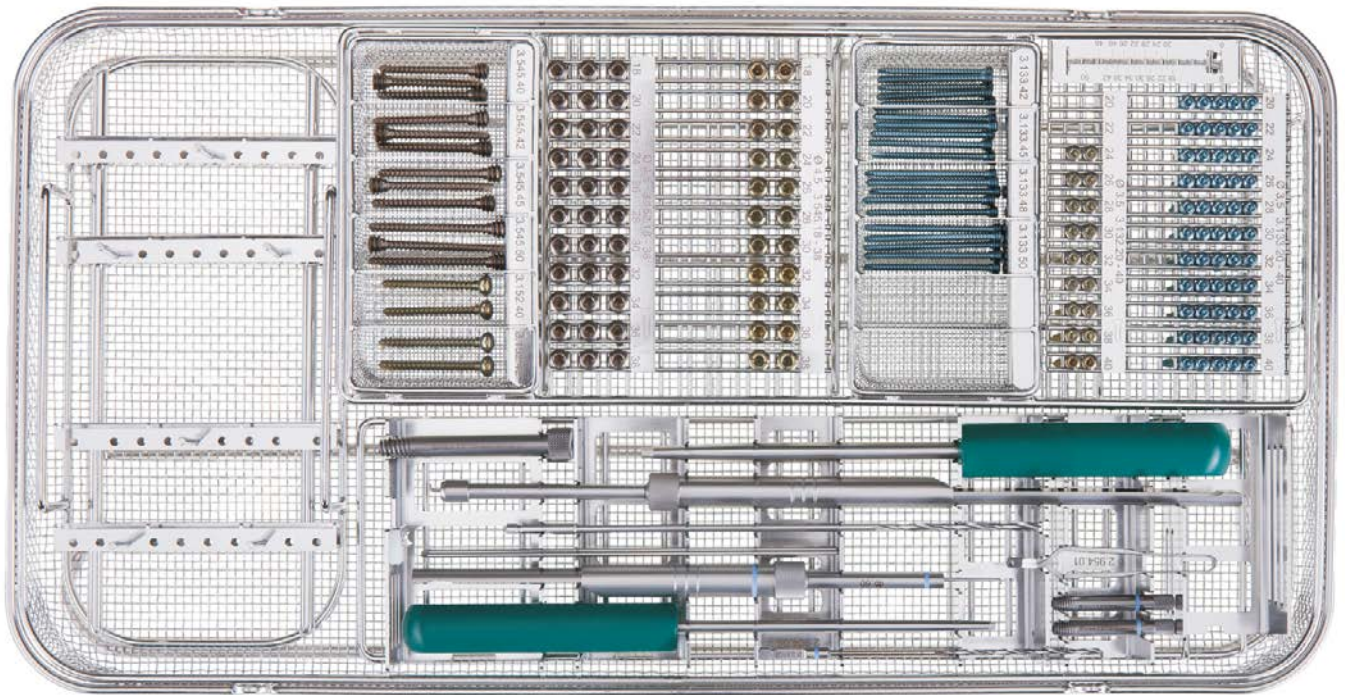

Module Screws - SFI

for SFI-Implants



Set - complete: 19.533.00

Set - autoclavable container: 19.532.00

■ Screws

Item designation		Code-No.	Quantity
Cortical screw; 3,5 x 10; fully threaded; st, T		3.132.10	2
Cortical screw; 3,5 x 12; fully threaded; st, T		3.132.12	2
Cortical screw; 3,5 x 14; fully threaded; st, T		3.132.14	2
Cortical screw; 3,5 x 16; fully threaded; st, T		3.132.16	2
Cortical screw; 3,5 x 18; fully threaded; st, T		3.132.18	2
Cortical screw; 3,5 x 20; fully threaded; st, T		3.132.20	2
Cortical screw; 3,5 x 22; fully threaded; st, T		3.132.22	2
Cortical screw; 3,5 x 24; fully threaded; st, T		3.132.24	2
Cortical screw; 3,5 x 26; fully threaded; st, T		3.132.26	2
Cortical screw; 3,5 x 28; fully threaded; st, T		3.132.28	2
Cortical screw; 3,5 x 30; fully threaded; st, T		3.132.30	2
Cortical screw; 3,5 x 32; fully threaded; st, T		3.132.32	2
Cortical screw; 3,5 x 34; fully threaded; st, T		3.132.34	2
Cortical screw; 3,5 x 36; fully threaded; st, T		3.132.36	2
Cortical screw; 3,5 x 38; fully threaded; st, T		3.132.38	2
Cortical screw; 3,5 x 40; fully threaded; st, T		3.132.40	2
Cortical screw; 3,5 x 45; fully threaded; st, T		3.132.45	2
Cortical screw; 3,5 x 50; fully threaded; st, T		3.132.50	2
Cortical screw; 3,5 x 55; fully threaded; st, T		3.132.55	2
Cortical screw; 3,5 x 60; fully threaded; st, T		3.132.60	2

Item designation		Code-No.	Quantity
Cortical screw w. con. thread; 3,5 x 10; fully threaded, st, T		3.133.10	5
Cortical screw w. con. thread; 3,5 x 12; fully threaded, st, T		3.133.12	5
Cortical screw w. con. thread; 3,5 x 14; fully threaded, st, T		3.133.14	5
Cortical screw w. con. thread; 3,5 x 16; fully threaded, st, T		3.133.16	5
Cortical screw w. con. thread; 3,5 x 18; fully threaded, st, T		3.133.18	5
Cortical screw w. con. thread; 3,5 x 20; fully threaded, st, T		3.133.20	5
Cortical screw w. con. thread; 3,5 x 22; fully threaded, st, T		3.133.22	5
Cortical screw w. con. thread; 3,5 x 24; fully threaded, st, T		3.133.24	5
Cortical screw w. con. thread; 3,5 x 26; fully threaded, st, T		3.133.26	5
Cortical screw w. con. thread; 3,5 x 28; fully threaded, st, T		3.133.28	5
Cortical screw w. con. thread; 3,5 x 30; fully threaded, st, T		3.133.30	5
Cortical screw w. con. thread; 3,5 x 32; fully threaded, st, T		3.133.32	5
Cortical screw w. con. thread; 3,5 x 34; fully threaded, st, T		3.133.34	5
Cortical screw w. con. thread; 3,5 x 36; fully threaded, st, T		3.133.36	5
Cortical screw w. con. thread; 3,5 x 38; fully threaded, st, T		3.133.38	5
Cortical screw w. con. thread; 3,5 x 40; fully threaded, st, T		3.133.40	4
Cortical screw w. con. thread; 3,5 x 45; fully threaded, st, T		3.133.45	4
Cortical screw w. con. thread; 3,5 x 50; fully threaded, st, T		3.133.50	4
Cortical screw w. con. thread; 3,5 x 55; fully threaded, st, T		3.133.55	4
Cortical screw w. con. thread; 3,5 x 60; fully threaded, st, T		3.133.60	4



KÖNIGSEE IMPLANTATE GmbH
 AM SAND
 D-07426 ALLENDORF
 Fon +49 (0) 36738 498-0
 Fax +49 (0) 36738 498-19
 e-Mail: info@koenigsee-implantate.de

04/2011/AnKi

More information on our website:
www.koenigsee-implantate.de

Module Screws - SFI

for SFI-Implants

■ Screws

Item designation		Code-No.	Quantity
Cancellous screw w. con. thread; 4 x 10; fully threaded; st, T		3.147.10	5
Cancellous screw w. con. thread; 4 x 12; fully threaded; st, T		3.147.12	5
Cancellous screw w. con. thread; 4 x 14; fully threaded; st, T		3.147.14	5
Cancellous screw w. con. thread; 4 x 16; fully threaded; st, T		3.147.16	5
Cancellous screw w. con. thread; 4 x 18; fully threaded; st, T		3.147.18	5
Cancellous screw w. con. thread; 4 x 20; fully threaded; st, T		3.147.20	5
Cancellous screw w. con. thread; 4 x 22; fully threaded; st, T		3.147.22	5
Cancellous screw w. con. thread; 4 x 24; fully threaded; st, T		3.147.24	5
Cancellous screw w. con. thread; 4 x 26; fully threaded; st, T		3.147.26	5
Cancellous screw w. con. thread; 4 x 28; fully threaded; st, T		3.147.28	5
Cancellous screw w. con. thread; 4 x 30; fully threaded; st, T		3.147.30	5
Cancellous screw w. con. thread; 4 x 32; fully threaded; st, T		3.147.32	5
Cancellous screw w. con. thread; 4 x 34; fully threaded; st, T		3.147.34	5
Cancellous screw w. con. thread; 4 x 36; fully threaded; st, T		3.147.36	5
Cancellous screw w. con. thread; 4 x 38; fully threaded; st, T		3.147.38	5
Cancellous screw w. con. thread; 4 x 40; fully threaded; st, T		3.147.40	4
Cancellous screw w. con. thread; 4 x 45; fully threaded; st, T		3.147.45	4
Cancellous screw w. con. thread; 4 x 50; fully threaded; st, T		3.147.50	4
Cancellous screw w. con. thread; 4 x 55; fully threaded; st, T		3.147.55	4
Cancellous screw w. con. thread; 4 x 60; fully threaded; st, T		3.147.60	4

Item designation		Code-No.	Quantity
Cancellous screw; 4 x 10; thread 5; bt, T		3.140.10	2
Cancellous screw; 4 x 12;thread 5; bt, T		3.140.12	2
Cancellous screw; 4 x 14;thread 5; bt, T		3.140.14	2
Cancellous screw; 4 x 16;thread 6; bt, T		3.140.16	2
Cancellous screw; 4 x 18;thread 7; bt, T		3.140.18	2
Cancellous screw; 4 x 20;thread 8; bt, T		3.140.20	2
Cancellous screw; 4 x 22;thread 9; bt, T		3.140.22	2
Cancellous screw; 4 x 24;thread 10; bt, T		3.140.24	2
Cancellous screw; 4 x 26;thread 12; bt, T		3.140.26	2
Cancellous screw; 4 x 28;thread 14; bt, T		3.140.28	2
Cancellous screw; 4 x 30;thread 14; bt, T		3.140.30	2
Cancellous screw; 4 x 32;thread 14; bt, T		3.140.32	2
Cancellous screw; 4 x 34;thread 14; bt, T		3.140.34	2
Cancellous screw; 4 x 36;thread 14; bt, T		3.140.36	2
Cancellous screw; 4 x 38;thread 14; bt, T		3.140.38	2
Cancellous screw; 4 x 40;thread 14; bt, T		3.140.40	1
Cancellous screw; 4 x 45;thread 15; bt, T		3.140.45	1
Cancellous screw; 4 x 50;thread 15; bt, T		3.140.50	1
Cancellous screw; 4 x 55;thread 16; bt, T		3.140.55	1
Cancellous screw; 4 x 60;thread 16; bt, T		3.140.60	1

Module Screws - SFI

for SFI-Implants

■ Screws

Item designation		Code-No.	Quantity
Cancellous screw; 4 x 10; fully threaded; T		3.145.10	2
Cancellous screw; 4 x 12; fully threaded; T		3.145.12	2
Cancellous screw; 4 x 14; fully threaded; T		3.145.14	2
Cancellous screw; 4 x 16; fully threaded; T		3.145.16	2
Cancellous screw; 4 x 18; fully threaded; T		3.145.18	2
Cancellous screw; 4 x 20; fully threaded; T		3.145.20	2
Cancellous screw; 4 x 22; fully threaded; T		3.145.22	2
Cancellous screw; 4 x 24; fully threaded; T		3.145.24	2
Cancellous screw; 4 x 26; fully threaded; T		3.145.26	2
Cancellous screw; 4 x 28; fully threaded; T		3.145.28	2
Cancellous screw; 4 x 30; fully threaded; T		3.145.30	2
Cancellous screw; 4 x 32; fully threaded; T		3.145.32	2
Cancellous screw; 4 x 34; fully threaded; T		3.145.34	2
Cancellous screw; 4 x 36; fully threaded; T		3.145.36	2
Cancellous screw; 4 x 38; fully threaded; T		3.145.38	2
Cancellous screw; 4 x 40; fully threaded; T		3.145.40	1
Cancellous screw; 4 x 45; fully threaded; T		3.145.45	1
Cancellous screw; 4 x 50; fully threaded; T		3.145.50	1
Cancellous screw; 4 x 55; fully threaded; T		3.145.55	1
Cancellous screw; 4 x 60; fully threaded; T		3.145.60	1

screw forceps, self holding		2.954.01	1
perforated autoclavable container with inset for screws		19.532.00	1

Module Screws - SFI

for SFI-Implants



Set - complete: 19.533.10

Set - autoclavable container: 19.532.10

■ Screws

Item designation	Code-No.	Quantity
Cortical screw; 3,5 x 10; fully threaded; st, T	3.132.10	2
Cortical screw; 3,5 x 12; fully threaded; st, T	3.132.12	2
Cortical screw; 3,5 x 14; fully threaded; st, T	3.132.14	2
Cortical screw; 3,5 x 16; fully threaded; st, T	3.132.16	2
Cortical screw; 3,5 x 18; fully threaded; st, T	3.132.18	2
Cortical screw; 3,5 x 20; fully threaded; st, T	3.132.20	2
Cortical screw; 3,5 x 22; fully threaded; st, T	3.132.22	2
Cortical screw; 3,5 x 24; fully threaded; st, T	3.132.24	2
Cortical screw; 3,5 x 26; fully threaded; st, T	3.132.26	2
Cortical screw; 3,5 x 28; fully threaded; st, T	3.132.28	2
Cortical screw; 3,5 x 30; fully threaded; st, T	3.132.30	2
Cortical screw; 3,5 x 32; fully threaded; st, T	3.132.32	2
Cortical screw; 3,5 x 34; fully threaded; st, T	3.132.34	2
Cortical screw; 3,5 x 36; fully threaded; st, T	3.132.36	2
Cortical screw; 3,5 x 38; fully threaded; st, T	3.132.38	2
Cortical screw; 3,5 x 40; fully threaded; st, T	3.132.40	2
Cortical screw; 3,5 x 45; fully threaded; st, T	3.132.45	2
Cortical screw; 3,5 x 50; fully threaded; st, T	3.132.50	2
Cortical screw; 3,5 x 55; fully threaded; st, T	3.132.55	2
Cortical screw; 3,5 x 60; fully threaded; st, T	3.132.60	2

Item designation	Code-No.	Quantity
Cortical screw w. con. thread; 3,5 x 10; fully threaded, st, T	3.133.10	5
Cortical screw w. con. thread; 3,5 x 12; fully threaded, st, T	3.133.12	5
Cortical screw w. con. thread; 3,5 x 14; fully threaded, st, T	3.133.14	5
Cortical screw w. con. thread; 3,5 x 16; fully threaded, st, T	3.133.16	5
Cortical screw w. con. thread; 3,5 x 18; fully threaded, st, T	3.133.18	5
Cortical screw w. con. thread; 3,5 x 20; fully threaded, st, T	3.133.20	5
Cortical screw w. con. thread; 3,5 x 22; fully threaded, st, T	3.133.22	5
Cortical screw w. con. thread; 3,5 x 24; fully threaded, st, T	3.133.24	5
Cortical screw w. con. thread; 3,5 x 26; fully threaded, st, T	3.133.26	5
Cortical screw w. con. thread; 3,5 x 28; fully threaded, st, T	3.133.28	5
Cortical screw w. con. thread; 3,5 x 30; fully threaded, st, T	3.133.30	5
Cortical screw w. con. thread; 3,5 x 32; fully threaded, st, T	3.133.32	5
Cortical screw w. con. thread; 3,5 x 34; fully threaded, st, T	3.133.34	5
Cortical screw w. con. thread; 3,5 x 36; fully threaded, st, T	3.133.36	5
Cortical screw w. con. thread; 3,5 x 38; fully threaded, st, T	3.133.38	5
Cortical screw w. con. thread; 3,5 x 40; fully threaded, st, T	3.133.40	4
Cortical screw w. con. thread; 3,5 x 45; fully threaded, st, T	3.133.45	4
Cortical screw w. con. thread; 3,5 x 50; fully threaded, st, T	3.133.50	4
Cortical screw w. con. thread; 3,5 x 55; fully threaded, st, T	3.133.55	4
Cortical screw w. con. thread; 3,5 x 60; fully threaded, st, T	3.133.60	4





KÖNIGSEE IMPLANTATE GmbH
AM SAND
D-07426 ALLENDORF
Fon +49 (0) 36738 498-0
Fax +49 (0) 36738 498-19
e-Mail: info@koenigsee-implantate.de

Module Screws - SFI

for SFI-Implants

■ Screws

Item designation		Code-No.	Quantity
Cortical screw w. con. thread; 4 x 10; fully threaded; st, T		3.148.10	5
Cortical screw w. con. thread; 4 x 12; fully threaded; st, T		3.148.12	5
Cortical screw w. con. thread; 4 x 14; fully threaded; st, T		3.148.14	5
Cortical screw w. con. thread; 4 x 16; fully threaded; st, T		3.148.16	5
Cortical screw w. con. thread; 4 x 18; fully threaded; st, T		3.148.18	5
Cortical screw w. con. thread; 4 x 20; fully threaded; st, T		3.148.20	5
Cortical screw w. con. thread; 4 x 22; fully threaded; st, T		3.148.22	5
Cortical screw w. con. thread; 4 x 24; fully threaded; st, T		3.148.24	5
Cortical screw w. con. thread; 4 x 26; fully threaded; st, T		3.148.26	5
Cortical screw w. con. thread; 4 x 28; fully threaded; st, T		3.148.28	5
Cortical screw w. con. thread; 4 x 30; fully threaded; st, T		3.148.30	5
Cortical screw w. con. thread; 4 x 32; fully threaded; st, T		3.148.32	5
Cortical screw w. con. thread; 4 x 34; fully threaded; st, T		3.148.34	5
Cortical screw w. con. thread; 4 x 36; fully threaded; st, T		3.148.36	5
Cortical screw w. con. thread; 4 x 38; fully threaded; st, T		3.148.38	5
Cortical screw w. con. thread; 4 x 40; fully threaded; st, T		3.148.40	4
Cortical screw w. con. thread; 4 x 45; fully threaded; st, T		3.148.45	4
Cortical screw w. con. thread; 4 x 50; fully threaded; st, T		3.148.50	4
Cortical screw w. con. thread; 4 x 55; fully threaded; st, T		3.148.55	4
Cortical screw w. con. thread; 4 x 60; fully threaded; st, T		3.148.60	4

Item designation		Code-No.	Quantity
Cancellous screw; 4 x 10; thread 5; bt, T		3.140.10	2
Cancellous screw; 4 x 12; thread 5; bt, T		3.140.12	2
Cancellous screw; 4 x 14; thread 5; bt, T		3.140.14	2
Cancellous screw; 4 x 16; thread 6; bt, T		3.140.16	2
Cancellous screw; 4 x 18; thread 7; bt, T		3.140.18	2
Cancellous screw; 4 x 20; thread 8; bt, T		3.140.20	2
Cancellous screw; 4 x 22; thread 9; bt, T		3.140.22	2
Cancellous screw; 4 x 24; thread 10; bt, T		3.140.24	2
Cancellous screw; 4 x 26; thread 12; bt, T		3.140.26	2
Cancellous screw; 4 x 28; thread 14; bt, T		3.140.28	2
Cancellous screw; 4 x 30; thread 14; bt, T		3.140.30	2
Cancellous screw; 4 x 32; thread 14; bt, T		3.140.32	2
Cancellous screw; 4 x 34; thread 14; bt, T		3.140.34	2
Cancellous screw; 4 x 36; thread 14; bt, T		3.140.36	2
Cancellous screw; 4 x 38; thread 14; bt, T		3.140.38	2
Cancellous screw; 4 x 40; thread 14; bt, T		3.140.40	1
Cancellous screw; 4 x 45; thread 15; bt, T		3.140.45	1
Cancellous screw; 4 x 50; thread 15; bt, T		3.140.50	1
Cancellous screw; 4 x 55; thread 16; bt, T		3.140.55	1
Cancellous screw; 4 x 60; thread 16; bt, T		3.140.60	1

Module Screws - SFI

for SFI-Implants

■ Screws

Item designation		Code-No.	Quantity
Cancellous screw; 4 x 10; fully threaded; T		3.145.10	2
Cancellous screw; 4 x 12; fully threaded; T		3.145.12	2
Cancellous screw; 4 x 14; fully threaded; T		3.145.14	2
Cancellous screw; 4 x 16; fully threaded; T		3.145.16	2
Cancellous screw; 4 x 18; fully threaded; T		3.145.18	2
Cancellous screw; 4 x 20; fully threaded; T		3.145.20	2
Cancellous screw; 4 x 22; fully threaded; T		3.145.22	2
Cancellous screw; 4 x 24; fully threaded; T		3.145.24	2
Cancellous screw; 4 x 26; fully threaded; T		3.145.26	2
Cancellous screw; 4 x 28; fully threaded; T		3.145.28	2
Cancellous screw; 4 x 30; fully threaded; T		3.145.30	2
Cancellous screw; 4 x 32; fully threaded; T		3.145.32	2
Cancellous screw; 4 x 34; fully threaded; T		3.145.34	2
Cancellous screw; 4 x 36; fully threaded; T		3.145.36	2
Cancellous screw; 4 x 38; fully threaded; T		3.145.38	2
Cancellous screw; 4 x 40; fully threaded; T		3.145.40	1
Cancellous screw; 4 x 45; fully threaded; T		3.145.45	1
Cancellous screw; 4 x 50; fully threaded; T		3.145.50	1
Cancellous screw; 4 x 55; fully threaded; T		3.145.55	1
Cancellous screw; 4 x 60; fully threaded; T		3.145.60	1

screw forceps, self holding  2.954.01 1

perforated autoclavable container with inset for screws 19.532.10 1

Module Screws - SFI

for SFI-Implants

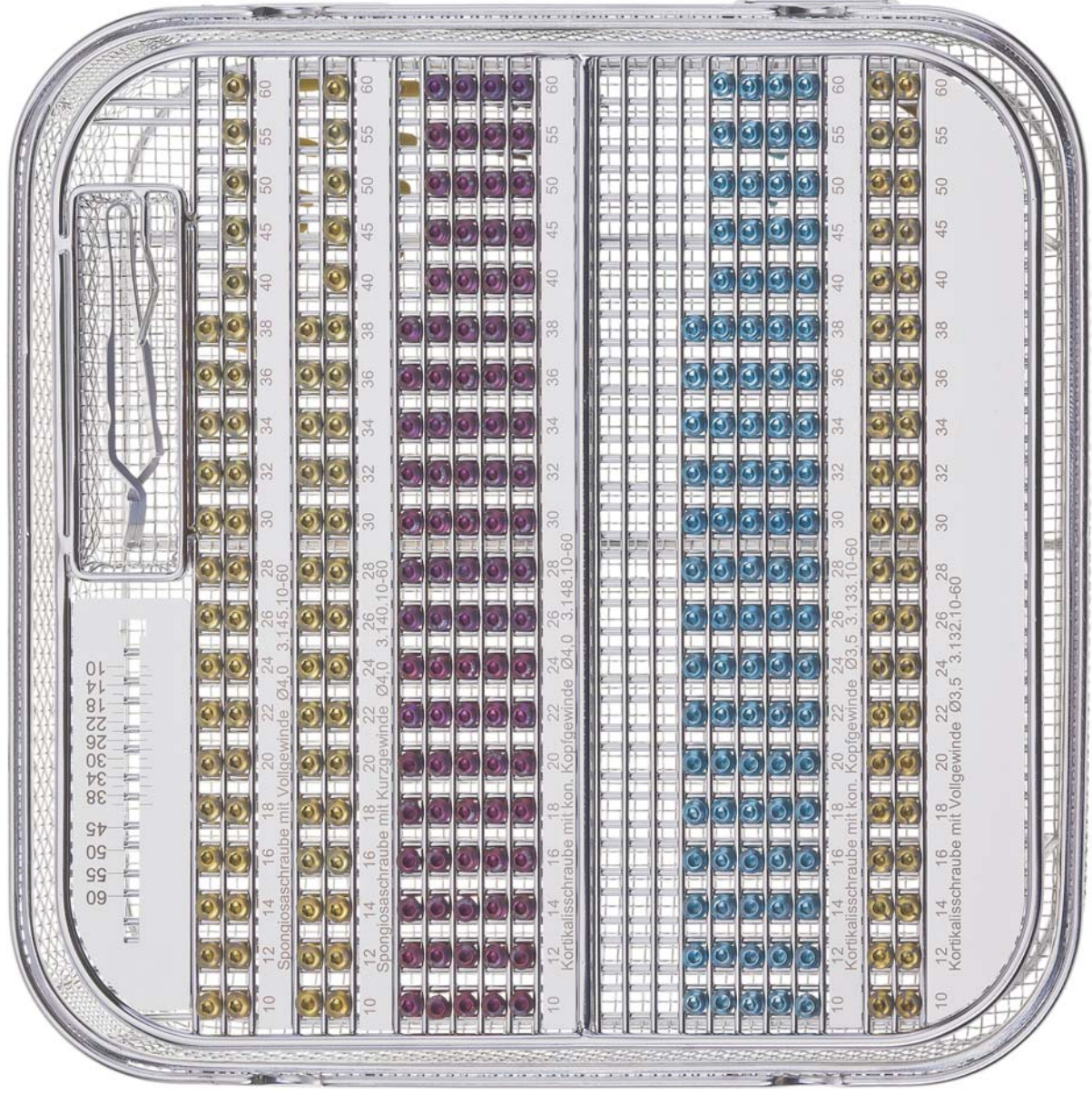

Module plates - Large fragment

titanium; Set No. 19.162.00

■ Semitubular plates

Item designation	Item No.	Quantity
Semitubular plate with round holes 4.5; 4 holes; 71x12; ti	5.500.04	0
Semitubular plate with round holes 4.5; 5 holes; 87x12; ti	5.500.05	0
Semitubular plate with round holes 4.5; 6 holes; 103x12; ti	5.500.06	0
Semitubular plate with round holes 4.5; 7 holes; 119x12; ti	5.500.07	0

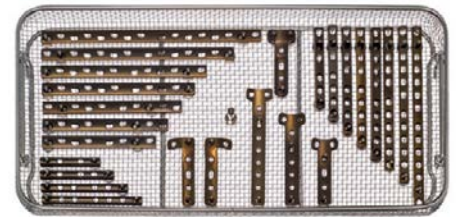

Item No.
complete set
titanium
19.162.00

■ Straight DC-plates - narrow

Item designation	Item No.	Quantity
Straight DC-plate 4.5 and 6.5; 6 holes; 103x12; narrow; ti	5.530.06	1
Straight DC-plate 4.5 and 6.5; 7 holes; 119x12; narrow; ti	5.530.07	1
Straight DC-plate 4.5 and 6.5; 8 holes; 135x12; narrow; ti	5.530.08	1
Straight DC-plate 4.5 and 6.5; 9 holes; 151x12; narrow; ti	5.530.09	1
Straight DC-plate 4.5 and 6.5; 10 holes; 167x12; narrow; ti	5.530.10	1
Straight DC-plate 4.5 and 6.5; 11 holes; 183x12; narrow; ti	5.530.11	1
Straight DC-plate 4.5 and 6.5; 12 holes; 199x12; narrow; ti	5.530.12	1
Straight DC-plate 4.5 and 6.5; 14 holes; 231x12; narrow; ti	5.530.14	1

■ Straight DC-plates - broad, staggered

Item designation	Item No.	Quantity
Straight DC-plate 4.5 and 6.5; 8 holes; 135x16; brad, staggered; ti	5.540.08	1
Straight DC-plate 4.5 and 6.5; 9 holes; 151x16; brad, staggered; ti	5.540.09	1
Straight DC-plate 4.5 and 6.5; 10 holes; 167x16; brad, staggered; ti	5.540.10	1
Straight DC-plate 4.5 and 6.5; 11 holes; 183x16; brad, staggered; ti	5.540.11	1
Straight DC-plate 4.5 and 6.5; 12 holes; 199x16; brad, staggered; ti	5.540.12	1
Straight DC-plate 4.5 and 6.5; 14 holes; 231x16; brad, staggered; ti	5.540.14	1
Straight DC-plate 4.5 and 6.5; 16 holes; 263x16; brad, staggered; ti	5.540.16	1

■ T-plate

Item designation	Item No.	Quantity
T-plate 6.5/4.5; 4 holes; 84x17; ti	5.720.04	1
T-plate 6.5/4.5; 6 holes; 116x17; ti	5.720.06	1
T-plate 6.5/4.5; 8 holes; 148x17; ti	5.720.08	1

■ T-support plate

Item designation	Item No.	Quantity
T-support plate 4.5; 4 holes; 81x17; ti	5.770.04	0

■ L-support plate

Item designation	Item No.	Quantity
L-support plate 6.5/4.5; 4 holes; 87x16; L; S	5.762.04	0
L-support plate 6.5/4.5; 4 holes; 87x16; R; S	5.760.04	0

■ Container

Item designation	Item No.	Quantity
Autoclavable container w. inset f. instruments module LFI	19.166.00	1



Königsee
Implantate

Königsee Implantate GmbH
OT Aschau | Am Sand 4
07426 Allendorf | Germany
Fon + 49 36738 498-360
Fax + 49 36738 498-559
E-Mail: export@koenigsee-implantate.de

09/02/2015

For further information please visit:
www.koenigsee-implantate.com

Module plates - Large fragment

titanium; Set No. 19.162.00

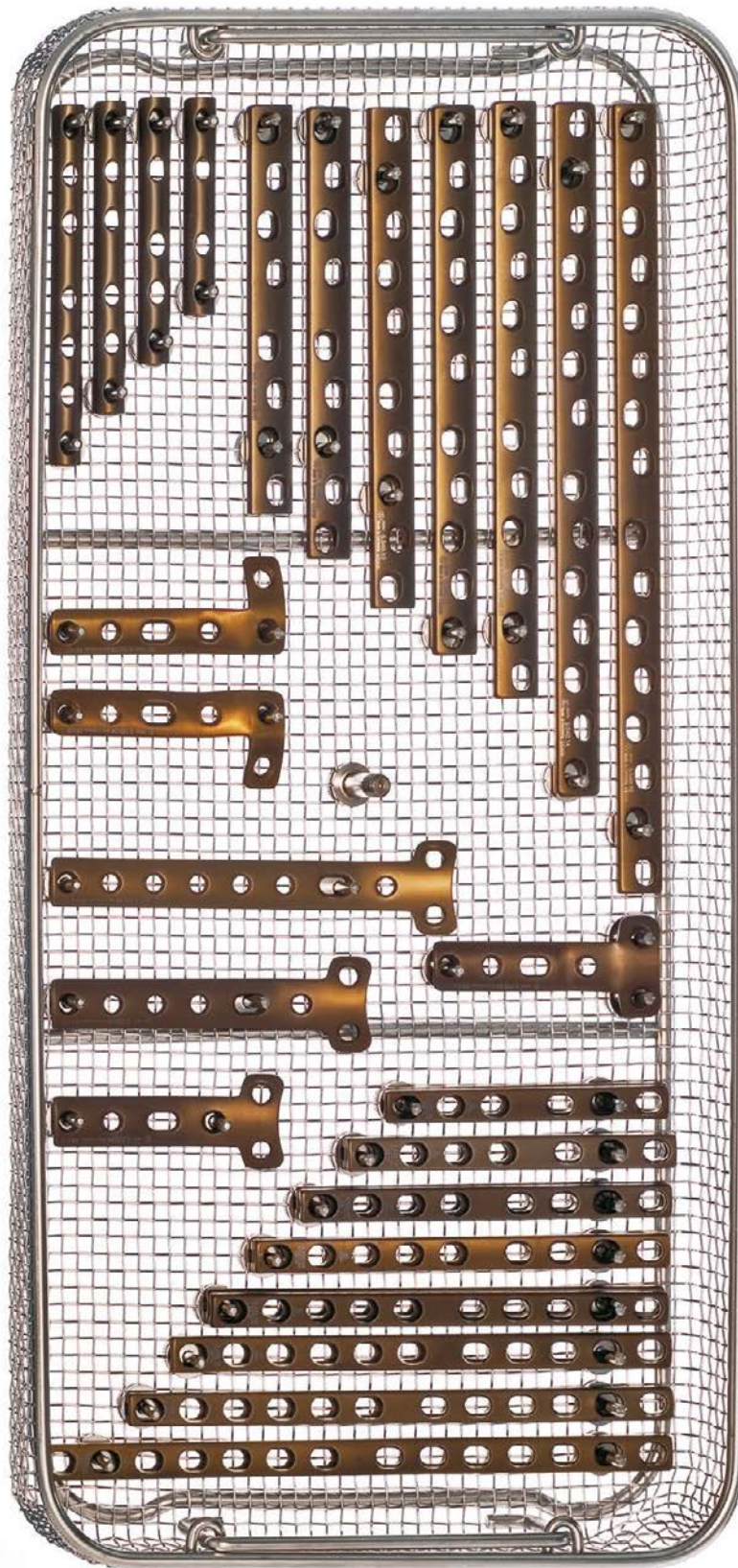

Module Plates - LFI

for LFI-instruments and screws - stainless steel

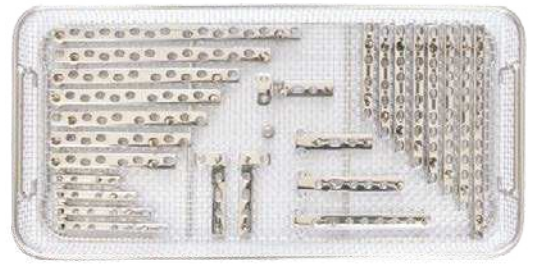

Code No.
complete set
stainless steel
19.161.00

■ Semitubular plates

Item designation	Code No.	Quantity
Semitubular plate with round holes 4.5;4 holes;71x12;st.st.	4.500.04	0
Semitubular plate with round holes 4.5;5 holes;87x12;st.st.	4.500.05	0
Semitubular plate with round holes 4.5;6 holes;103x12;st.st.	4.500.06	0
Semitubular plate with round holes 4.5;7 holes;119x12;st.st.	4.500.07	0

■ Straight DC-plates - narrow

Item designation	Code No.	Quantity
Straight DC-plate 4.5 and 6.5;6 holes;103x12;narrow;st.st.	4.530.06	1
Straight DC-plate 4.5 and 6.5;7 holes;119x12;narrow;st.st.	4.530.07	1
Straight DC-plate 4.5 and 6.5;8 holes;135x12;narrow;st.st.	4.530.08	1
Straight DC-plate 4.5 and 6.5;9 holes;151x12;narrow;st.st.	4.530.09	1
Straight DC-plate 4.5 and 6.5;10 holes;167x12;narrow;st.st.	4.530.10	1
Straight DC-plate 4.5 and 6.5;11 holes;183x12;narrow;st.st.	4.530.11	1
Straight DC-plate 4.5 and 6.5;12 holes;199x12;narrow;st.st.	4.530.12	1
Straight DC-plate 4.5 and 6.5;14 holes;231x12;narrow;st.st.	4.530.14	1

■ Straight DC-plates - broad, staggered

Item designation	Code No.	Quantity
Straight DC-plate 4.5 and 6.5;8 holes;135x16;brad,staggered;st.st.	4.540.08	1
Straight DC-plate 4.5 and 6.5;9 holes;151x16;brad,staggered;st.st.	4.540.09	1
Straight DC-plate 4.5 and 6.5;10 holes;167x16;brad,staggered;st.st.	4.540.10	1
Straight DC-plate 4.5 and 6.5;11 holes;183x16;brad,staggered;st.st.	4.540.11	1
Straight DC-plate 4.5 and 6.5;12 holes;199x16;brad,staggered;st.st.	4.540.12	1
Straight DC-plate 4.5 and 6.5;14 holes;231x16;brad,staggered;st.st.	4.540.14	1
Straight DC-plate 4.5 and 6.5;16 holes;263x16;brad,staggered;st.st.	4.540.16	1

■ T-plate

Item designation	Code No.	Quantity
T-plate 6.5/4.5;4 holes;84x17;st.st.	4.720.04	0
T-plate 6.5/4.5;6 holes;116x17;st.st.	4.720.06	0
T-plate 6.5/4.5;8 holes;148x17;st.st.	4.720.08	0

■ T-support plate

Item designation	Code No.	Quantity
T-support plate 4.5;4 holes;81x17;st.st.	4.770.04	0

■ L-support plate

Item designation	Code No.	Quantity
L-support plate 6.5/4.5;4 holes;87x16;L;S	4.762.04	0
L-support plate 6.5/4.5;4 holes;87x16;R;S	4.760.04	0

■ Storage

Item designation	Code No.	Quantity
Autoclavable container w. inset f. instruments module LFI	19.166.00	1



02/2012/AnKi

Königsee Implantate GmbH
 OT Aschau - Am Sand 4
 D-07426 Allendorf
 Fon +49 (0) 36738 498-0
 Fax +49 (0) 36738 498-19
 e-Mail: info@koenigsee-implantate.de

further information:
www.koenigsee-implantate.de

Module Plates - LFI

for LFI-instruments and screws - stainless steel

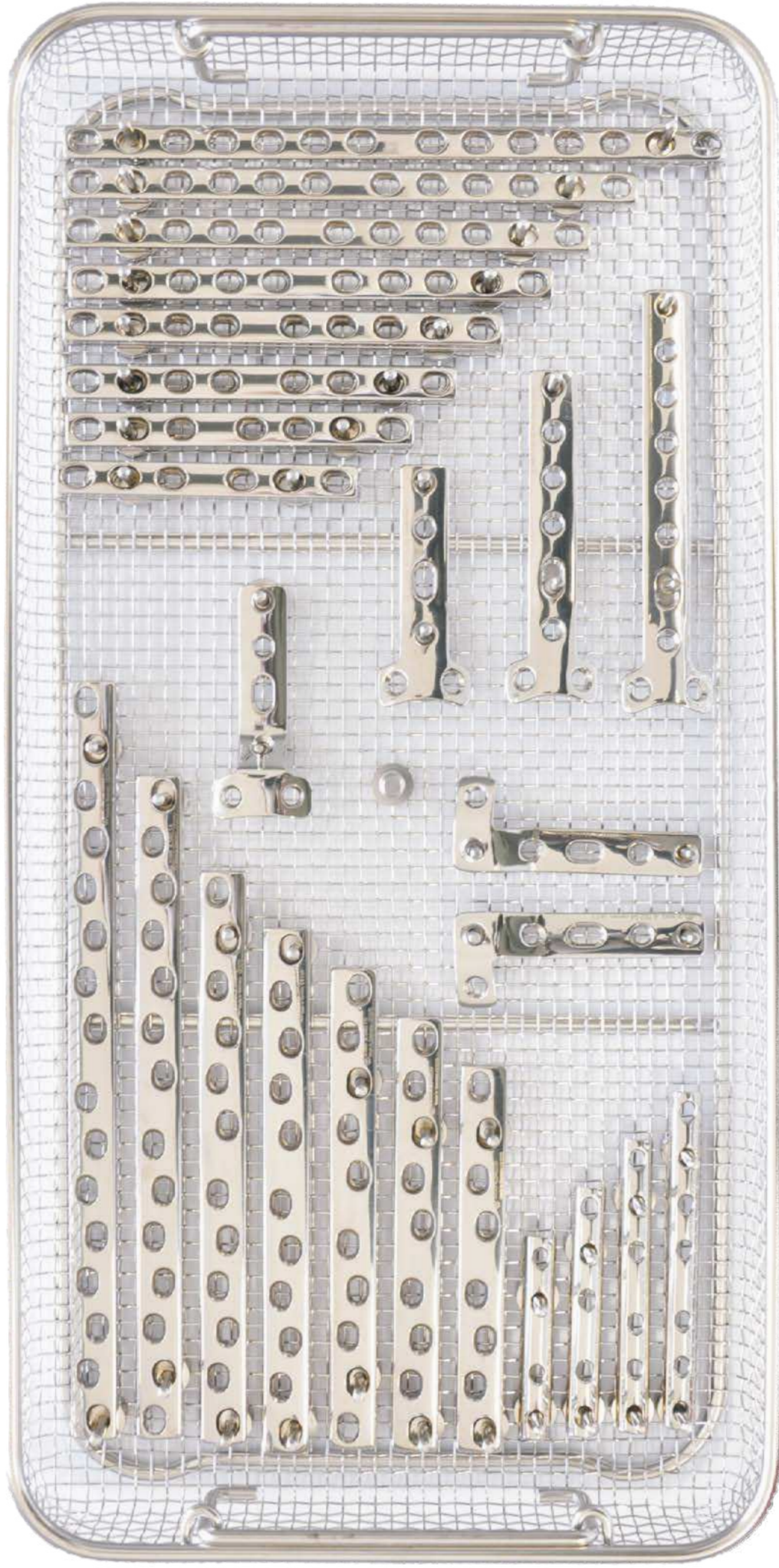

Module Instruments - LFI

for LFI-implants

■ Instruments

Item designation	Code No.	Quantity
Drill bit f. quick coupling; D 3.2x145; Spl 60; double spiral	2.904.08	1
Drill bit f. quick coupling; D 4.5x145; Spl 60; double spiral	2.904.12	1
Countersink w. T-handle, length 180, for screws Ø4.5 and Ø6.5	10.505.80	1
Countersink f. quick coupling, length 110, for screws Ø4.5 and Ø6.5	10.505.81	1
Tap for quick coupling for cortical screws, Ø4.5x130, thread 70	2.925.45	1
tap for quick coupling for cancellous screws, Ø6.5x170, thread 120	2.927.65	1
T-handle with quick coupling, length 93.5	10.305.05	1
Drill guide for neutral and compression position, Ø3.2	10.500.21	1
Double drill guide, Ø3.2/Ø4.5	10.500.02	1
Double drill guide, Ø3.2/Ø6.5	10.500.05	1
Inserting drill guide, Ø4.5/Ø3.2	10.510.45	1
Universal drill guide, Ø4.5	10.502.45	1
Universal drill guide, Ø3.2	10.502.32	1
Hex screwdriver with handle for screw Ø4.5-Ø7.0, length 215	2.940.35	1
Hex screwdriver inset f. quick coupling f. screw Ø4.5-Ø7.0 wrench width 3.5	2.941.35	1
Gauge with clasp for screws Ø4.5 and Ø6.5, measuring range 120	2.953.45	1
Sharp hook	10.508.00	1
Self-holding forceps	2.954.01	1
Quadrangular positioning plate with point	10.160.00	1
Combination wrench, wrench width 11	2.966.11	1

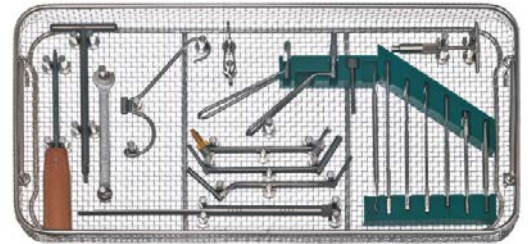

Code No.
complete set
Titanium
19.160.00

■ Storage

Item designation	Code No.	Quantity
Autoclavable container w. inset f. instruments module LFI	19.165.00	1

Module Instruments - LFI

for LFI-implants

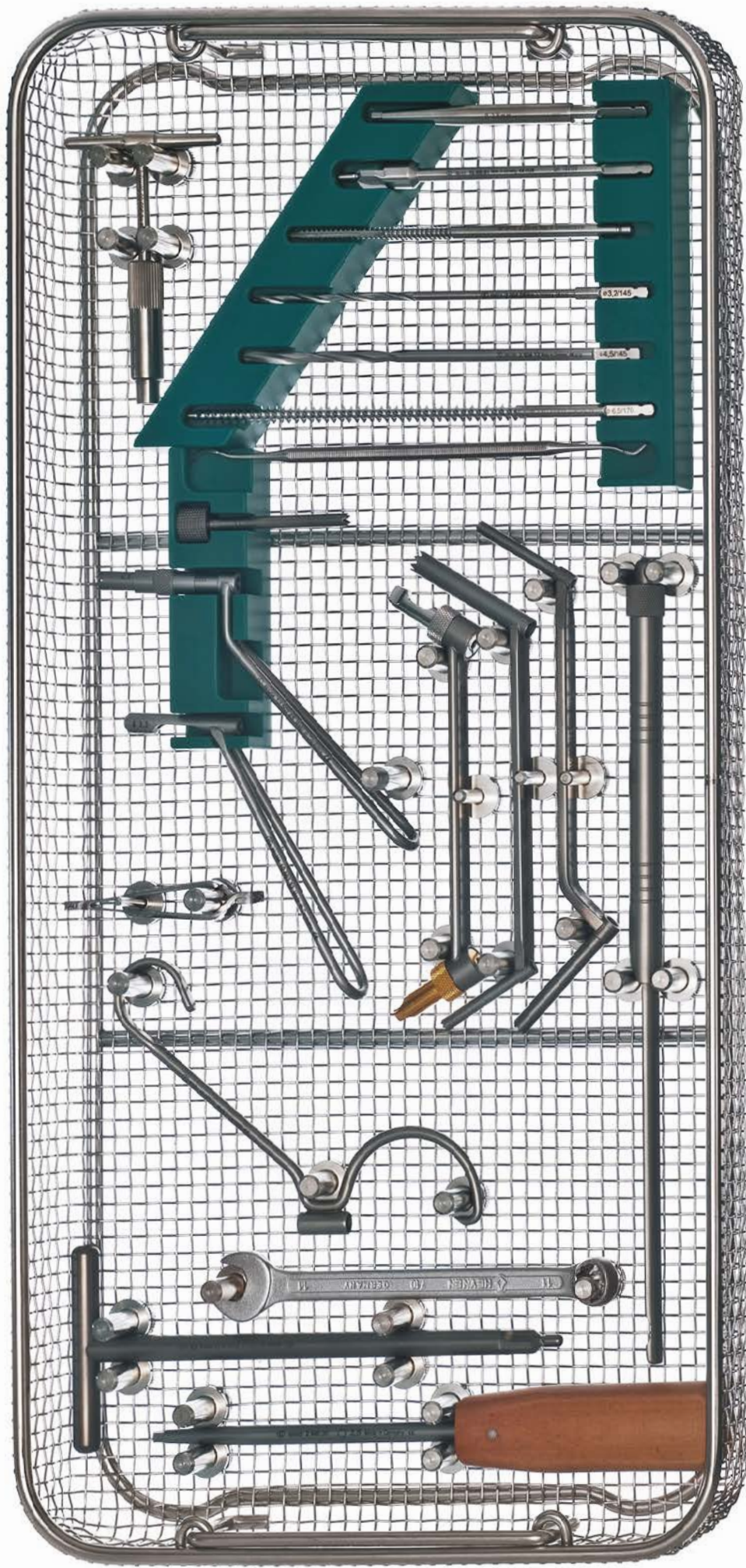

Straight plates Mini

standard; for screws \varnothing 1.5 mm; \varnothing 2.0 mm; \varnothing 2.7 mm; titanium



Item no. 5.404.15



Item no. 5.900.06



Item no. 5.825.04









Item no. 5.307.20

Item no.	Item description	EAN
Straight plate Mini 1.5 – plate thickness 1.0 mm		
5.404.15	straight mini plate 1.5; 20 holes; 100 x 4 mm; titanium	 4 047075 004942
Adaption plate Mini 2.0 – plate thickness 0.9 mm		
5.307.20	mini adaptation-plate 2.0; 20 holes; 100 x 5 mm; titanium	 4 047075 003907
Straight plate Mini 2.0 – plate thickness 1.0 mm		
5.900.03	straight mini plate with round holes 2.0; 3 holes; 17 x 5 mm; titanium	 4 047075 011124
5.900.04	straight mini plate with round holes 2.0; 4 holes; 23 x 5 mm; titanium	 4 047075 011384
5.900.05	straight mini plate with round holes 2.0; 5 holes; 29 x 5 mm; titanium	 4 047075 011391
5.900.06	straight mini plate with round holes 2.0; 6 holes; 35 x 5 mm; titanium	 4 047075 011407
Straight plate Mini 2.0 DC bridge 8 – plate thickness 1.0 mm		
5.406.02	straight DC-mini plate with bridge 2.0; 2 holes; 12 x 5 mm; bridge 8; titanium	 4 047075 004799
5.406.03	straight DC-mini plate with bridge 2.0; 3 holes; 17 x 5 mm; bridge 8; titanium	 4 047075 005048
5.406.04	straight DC-mini plate with bridge 2.0; 4 holes; 22 x 5 mm; bridge 8; titanium	 4 047075 005055
5.406.05	straight DC-mini plate with bridge 2.0; 5 holes; 27 x 5 mm; bridge 8; titanium	 4 047075 005062
5.406.06	straight DC-mini plate with bridge 2.0; 6 holes; 32 x 5 mm; bridge 8; titanium	 4 047075 005079
5.406.07	straight DC-mini plate with bridge 2.0; 7 holes; 37 x 5 mm; bridge 8; titanium	 4 047075 005017
5.406.08	straight DC-mini plate with bridge 2.0; 8 holes; 42 x 5 mm; bridge 8; titanium	 4 047075 004867
5.406.10	straight DC-mini plate with bridge 2.0; 10 holes; 52 x 5 mm; bridge 8; titanium	 4 047075 005093
Straight plate Mini 2.7 DC bridge 12 – plate thickness 2.5 mm		
5.825.02	straight DC-mini plate with bridge 2.7; 2 holes; 20 x 8 mm; bridge 12; titanium	 4 047075 009978
5.825.03	straight DC-mini plate with bridge 2.7; 3 holes; 28 x 8 mm; bridge 12; titanium	 4 047075 009985
5.825.04	straight DC-mini plate with bridge 2.7; 4 holes; 36 x 8 mm; bridge 12; titanium	 4 047075 009992
5.825.05	straight DC-mini plate with bridge 2.7; 5 holes; 44 x 8 mm; bridge 12; titanium	 4 047075 009970

Straight plates Mini

standard; for screws \varnothing 1.5 mm; \varnothing 2.0 mm; \varnothing 2.7 mm; titanium

Item no.	Item description	EAN
5.825.06	straight DC-mini plate with bridge 2.7; 6 holes; 52 x 8 mm; bridge 12; titanium	 4 047075 010028
5.825.07	straight DC-mini plate with bridge 2.7; 7 holes; 60 x 8 mm; bridge 12; titanium	 4 047075 010035
5.825.08	straight DC-mini plate with bridge 2.7; 8 holes; 68 x 8 mm; bridge 12; titanium	 4 047075 009855
5.825.09	straight DC-mini plate with bridge 2.7; 9 holes; 76 x 8 mm; bridge 12; titanium	 4 047075 009862
5.825.10	straight DC-mini plate with bridge 2.7; 10 holes; 84 x 8 mm; bridge 12; titanium	 4 047075 010004
5.825.11	straight DC-mini plate with bridge 2.7; 11 holes; 92 x 8 mm; bridge 12; titanium	 4 047075 010011
5.825.12	straight DC-mini plate with bridge 2.7; 12 holes; 100 x 8 mm; bridge 12; titanium	 4 047075 010073

Straight plates Mini 2.0 as



angle-stable; for screws \varnothing 2.0 mm; titanium



Item no. 5.9012.05



Item no. 5.9022.04

Item no.	Item description	EAN
Straight plate Mini 2.0 as – plate thickness 1.0 mm		
5.9012.05	straight plate with conical thread 2.0; 5 holes; 29 x 5 mm; titanium	 4 047075 129799
5.9012.13	straight plate with conical thread 2.0; 13 holes; 77 x 5 mm; titanium	 4 047075 129805
Straight plate Mini 2.0 as round bridge – plate thickness 1.2 mm		
5.9022.04	mini bridge plate with conical thread 2.0; 4 holes; 29 x 5 mm; titanium	 4 047075 148806

Straight plates Mini

standard; for screws Ø 1.5 mm; Ø 2.0 mm; Ø 2.7 mm; stainless steel



Item no. 4.404.06



Item no. 4.900.05



Item no. 4.307.20



Item no. 4.406.06



Item no. 4.408.08/08



Item no. 4.408.08

Item no.	Item description	EAN
Straight plate Mini 1.5 – plate thickness 0.9 mm		
4.404.04	straight mini plate 1.5; 4 holes; 20 x 4 mm; stainless steel	
4.404.06	straight mini plate 1.5; 6 holes; 30 x 4 mm; stainless steel	
4.404.07	straight mini plate 1.5; 7 holes; 35 x 4 mm; stainless steel	
4.404.08	straight mini plate 1.5; 8 holes; 40 x 4 mm; stainless steel	
4.404.15	straight mini plate 1.5; 20 holes; 100 x 4 mm; stainless steel	
Adaption plate Mini 2.0 – plate thickness 1.2 mm		
4.307.20	mini adaptation-plate 2.0; 20 holes; 100 x 5 mm; stainless steel	
Straight plate Mini 2.0 – plate thickness 1.0 mm		
4.900.03	straight mini plate with round holes 2.0; 3 holes; 17 x 5 mm; stainless steel	
4.900.04	straight mini plate with round holes 2.0; 4 holes; 23 x 5 mm; stainless steel	
4.900.05	straight mini plate with round holes 2.0; 5 holes; 29 x 5 mm; stainless steel	
4.900.06	straight mini plate with round holes 2.0; 6 holes; 35 x 5 mm; stainless steel	
4.900.07	straight mini plate with round holes 2.0; 7 holes; 41 x 5 mm; stainless steel	
4.900.08	straight mini plate with round holes 2.0; 8 holes; 47 x 5 mm; stainless steel	
4.900.20	straight mini plate with round holes 2.0; 20 holes; 119 x 5 mm; stainless steel	
Straight plate Mini 2.0 DC bridge 8 – plate thickness 1.0 mm		
4.406.02	straight DC-mini plate with bridge 2.0; 2 holes; 12 x 5 mm; bridge 8; stainless steel	
4.406.03	straight DC-mini plate with bridge 2.0; 3 holes; 17 x 5 mm; bridge 8; stainless steel	
4.406.04	straight DC-mini plate with bridge 2.0; 4 holes; 22 x 5 mm; bridge 8; stainless steel	
4.406.05	straight DC-mini plate with bridge 2.0; 5 holes; 27 x 5 mm; bridge 8; stainless steel	
4.406.06	straight DC-mini plate with bridge 2.0; 6 holes; 32 x 5 mm; bridge 8; stainless steel	
4.406.07	straight DC-mini plate with bridge 2.0; 7 holes; 37 x 5 mm; bridge 8; stainless steel	
4.406.08	straight DC-mini plate with bridge 2.0; 8 holes; 42 x 5 mm; bridge 8; stainless steel	

Straight plates Mini

standard; for screws Ø 1.5 mm; Ø 2.0 mm; Ø 2.7 mm; stainless steel



Item no. 4.408.08/15



Item no. 4.409.06



Item no. 4.410.08/St.



Item no. 4.825.06



Item no. 4.410.06

















Item no. 4.410.06/18

Item no.	Item description	EAN
4.406.09	straight DC-mini plate with bridge 2.0; 9 holes; 47 x 5 mm; bridge 8; stainless steel	
4.406.10	straight DC-mini plate with bridge 2.0; 10 holes; 52 x 5 mm; bridge 8; stainless steel	
4.406.12	straight DC-mini plate with bridge 2.0; 12 holes; 62 x 5 mm; bridge 8; stainless steel	
4.406.13	straight DC-mini plate with bridge 2.0; 13 holes; 67 x 5 mm; bridge 8; stainless steel	
4.406.14	straight DC-mini plate with bridge 2.0; 14 holes; 72 x 5 mm; bridge 8; stainless steel	
4.406.15	straight DC-mini plate with bridge 2.0; 15 holes; 77 x 5 mm; bridge 8; stainless steel	
4.406.16	straight DC-mini plate with bridge 2.0; 16 holes; 82 x 5 mm; bridge 8; stainless steel	
4.406.18	straight DC-mini plate with bridge 2.0; 18 holes; 92 x 5 mm; bridge 8; stainless steel	
Straight plate Mini 2.0 DC bridge 8 strong – plate thickness 2.0 mm		
4.408.04/08	straight DC-mini plate with bridge 2.0; 4 holes; 22 x 5 mm; bridge 8; stainless steel	
4.408.05/08	straight DC-mini plate with bridge 2.0; 5 holes; 27 x 5 mm; bridge 8; stainless steel	
4.408.06/08	straight DC-mini plate with bridge 2.0; 6 holes; 32 x 5 mm; bridge 8; stainless steel	
4.408.07/08	straight DC-mini plate with bridge 2.0; 7 holes; 37 x 5 mm; bridge 8; stainless steel	
4.408.08/08	straight DC-mini plate with bridge 2.0; 8 holes; 42 x 5 mm; bridge 8; stainless steel	
4.408.09/08	straight DC-mini plate with bridge 2.0; 9 holes; 47 x 5 mm; bridge 8; stainless steel	
4.408.10/08	straight DC-mini plate with bridge 2.0; 10 holes; 52 x 5 mm; bridge 8; stainless steel	
4.408.11/08	straight DC-mini plate with bridge 2.0; 11 holes; 57 x 5 mm; bridge 8; stainless steel	
4.408.12/08	straight DC-mini plate with bridge 2.0; 12 holes; 62 x 5 mm; bridge 8; stainless steel	
4.408.13/08	straight DC-mini plate with bridge 2.0; 13 holes; 67 x 5 mm; bridge 8; stainless steel	
4.408.14/08	straight DC-mini plate with bridge 2.0; 14 holes; 72 x 5 mm; bridge 8; stainless steel	
4.408.15/08	straight DC-mini plate with bridge 2.0; 15 holes; 77 x 5 mm; bridge 8; stainless steel	
4.408.16/08	straight DC-mini plate with bridge 2.0; 16 holes; 82 x 5 mm; bridge 8; stainless steel	
Straight plate Mini 2.0 DC bridge 12 – plate thickness 2.0 mm		
4.408.02	straight DC-mini plate with bridge 2.0; 2 holes; 17 x 5 mm; bridge 12; stainless steel	
4.408.03	straight DC-mini plate with bridge 2.0; 3 holes; 22 x 5 mm; bridge 12; stainless steel	

Straight plates Mini



standard; for screws Ø 1.5 mm; Ø 2.0 mm; Ø 2.7 mm; stainless steel

Item no.	Item description	EAN
4.408.04	straight DC-mini plate with bridge 2.0; 4 holes; 27 x 5 mm; bridge 12; stainless steel	
4.408.05	straight DC-mini plate with bridge 2.0; 5 holes; 32 x 5 mm; bridge 12; stainless steel	
4.408.06	straight DC-mini plate with bridge 2.0; 6 holes; 37 x 5 mm; bridge 12; stainless steel	
4.408.07	straight DC-mini plate with bridge 2.0; 7 holes; 42 x 5 mm; bridge 12; stainless steel	
4.408.08	straight DC-mini plate with bridge 2.0; 8 holes; 47 x 5 mm; bridge 12; stainless steel	
4.408.09	straight DC-mini plate with bridge 2.0; 9 holes; 52 x 5 mm; bridge 12; stainless steel	
4.408.10	straight DC-mini plate with bridge 2.0; 10 holes; 57 x 5 mm; bridge 12; stainless steel	
4.408.11	straight DC-mini plate with bridge 2.0; 11 holes; 62 x 5 mm; bridge 12; stainless steel	
4.408.12	straight DC-mini plate with bridge 2.0; 12 holes; 67 x 5 mm; bridge 12; stainless steel	
4.408.13	straight DC-mini plate with bridge 2.0; 13 holes; 72 x 5 mm; bridge 12; stainless steel	
4.408.14	straight DC-mini plate with bridge 2.0; 14 holes; 77 x 5 mm; bridge 12; stainless steel	
4.408.15	straight DC-mini plate with bridge 2.0; 15 holes; 82 x 5 mm; bridge 12; stainless steel	
4.408.16	straight DC-mini plate with bridge 2.0; 16 holes; 87 x 5 mm; bridge 12; stainless steel	
4.408.18	straight DC-mini plate with bridge 2.0; 18 holes; 97 x 5 mm; bridge 12; stainless steel	
4.408.20	straight DC-mini plate with bridge 2.0; 20 holes; 107 x 5 mm; bridge 12; stainless steel	

Straight plate Mini 2.0 DC bridge 15 – plate thickness 2.0 mm































4.408.05/15	straight DC-mini plate with bridge 2.0; 5 holes; 35 x 5 mm; bridge 15; stainless steel	
4.408.06/15	straight DC-mini plate with bridge 2.0; 6 holes; 40 x 5 mm; bridge 15; stainless steel	
4.408.07/15	straight DC-mini plate with bridge 2.0; 7 holes; 45 x 5 mm; bridge 15; stainless steel	
4.408.08/15	straight DC-mini plate with bridge 2.0; 8 holes; 50 x 5 mm; bridge 15; stainless steel	
4.408.09/15	straight DC-mini plate with bridge 2.0; 9 holes; 55 x 5 mm; bridge 15; stainless steel	
4.408.10/15	straight DC-mini plate with bridge 2.0; 10 holes; 60 x 5 mm; bridge 15; stainless steel	
4.408.11/15	straight DC-mini plate with bridge 2.0; 11 holes; 65 x 5 mm; bridge 15; stainless steel	
4.408.12/15	straight DC-mini plate with bridge 2.0; 12 holes; 70 x 5 mm; bridge 15; stainless steel	
4.408.13/15	straight DC-mini plate with bridge 2.0; 13 holes; 75 x 5 mm; bridge 15; stainless steel	
4.408.14/15	straight DC-mini plate with bridge 2.0; 14 holes; 80 x 5 mm; bridge 15; stainless steel	
4.408.15/15	straight DC-mini plate with bridge 2.0; 15 holes; 85 x 5 mm; bridge 15; stainless steel	
4.408.16/15	straight DC-mini plate with bridge 2.0; 16 holes; 90 x 5 mm; bridge 15; stainless steel	

Straight plate Mini 2.0 DC bridge 27 – plate thickness 2.0 mm

4.409.06	straight DC-mini plate with bridge 2.0; 6 holes; 52 x 5 mm; bridge 27; stainless steel	
4.409.07	straight DC-mini plate with bridge 2.0; 7 holes; 57 x 5 mm; bridge 27; stainless steel	
4.409.08	straight DC-mini plate with bridge 2.0; 8 holes; 62 x 5 mm; bridge 27; stainless steel	

Straight plates Mini

standard; for screws Ø 1.5 mm; Ø 2.0 mm; Ø 2.7 mm; stainless steel

Item no.	Item description	EAN
4.409.09	straight DC-mini plate with bridge 2.0; 9 holes; 67 x 5 mm; bridge 27; stainless steel	
4.409.10	straight DC-mini plate with bridge 2.0; 10 holes; 72 x 5 mm; bridge 27; stainless steel	
4.409.12	straight DC-mini plate with bridge 2.0; 12 holes; 82 x 5 mm; bridge 27; stainless steel	
4.409.14	straight DC-mini plate with bridge 2.0; 14 holes; 92 x 5 mm; bridge 27; stainless steel	
4.409.16	straight DC-mini plate with bridge 2.0; 16 holes; 102 x 5 mm; bridge 27; stainless steel	
4.409.18	straight DC-mini plate with bridge 2.0; 18 holes; 112 x 5 mm; bridge 27; stainless steel	
Straight plate Mini 2.7 DC bridge 12 arched – plate thickness 2.5 mm		
4.825.02	straight DC-mini plate with bridge 2.7; 2 holes; 20 x 8 mm; bridge 12; stainless steel	
4.825.03	straight DC-mini plate with bridge 2.7; 3 holes; 28 x 8 mm; bridge 12; stainless steel	
4.825.04	straight DC-mini plate with bridge 2.7; 4 holes; 36 x 8 mm; bridge 12; stainless steel	
4.825.05	straight DC-mini plate with bridge 2.7; 5 holes; 44 x 8 mm; bridge 12; stainless steel	
4.825.06	straight DC-mini plate with bridge 2.7; 6 holes; 52 x 8 mm; bridge 12; stainless steel	
4.825.07	straight DC-mini plate with bridge 2.7; 7 holes; 60 x 8 mm; bridge 12; stainless steel	
4.825.08	straight DC-mini plate with bridge 2.7; 8 holes; 68 x 8 mm; bridge 12; stainless steel	
4.825.09	straight DC-mini plate with bridge 2.7; 9 holes; 76 x 8 mm; bridge 12; stainless steel	
4.825.10	straight DC-mini plate with bridge 2.7; 10 holes; 84 x 8 mm; bridge 12; stainless steel	
4.825.11	straight DC-mini plate with bridge 2.7; 11 holes; 92 x 8 mm; bridge 12; stainless steel	
4.825.12	straight DC-mini plate with bridge 2.7; 12 holes; 100 x 8 mm; bridge 12; stainless steel	
4.825.13	straight DC-mini plate with bridge 2.7; 13 holes; 108 x 8 mm; bridge 12; stainless steel	
4.825.14	straight DC-mini plate with bridge 2.7; 14 holes; 116 x 8 mm; bridge 12; stainless steel	
4.825.15	straight DC-mini plate with bridge 2.7; 15 holes; 124 x 8 mm; bridge 12; stainless steel	
4.825.16	straight DC-mini plate with bridge 2.7; 16 holes; 132 x 8 mm; bridge 12; stainless steel	
Straight plate Mini 2.7 DC bridge 12 – plate thickness 2.5 mm		
4.410.02	straight DC-mini plate with bridge 2.7; 2 holes; 21 x 8 mm; bridge 12; stainless steel	
4.410.04	straight DC-mini plate with bridge 2.7; 4 holes; 37 x 8 mm; bridge 12; stainless steel	
4.410.05	straight DC-mini plate with bridge 2.7; 5 holes; 45 x 8 mm; bridge 12; stainless steel	
4.410.06	straight DC-mini plate with bridge 2.7; 6 holes; 53 x 8 mm; bridge 12; stainless steel	
4.410.07	straight DC-mini plate with bridge 2.7; 7 holes; 61 x 8 mm; bridge 12; stainless steel	
4.410.08	straight DC-mini plate with bridge 2.7; 8 holes; 69 x 8 mm; bridge 12; stainless steel	
4.410.09	straight DC-mini plate with bridge 2.7; 9 holes; 77 x 8 mm; bridge 12; stainless steel	
4.410.10	straight DC-mini plate with bridge 2.7; 10 holes; 85 x 8 mm; bridge 12; stainless steel	
4.410.11	straight DC-mini plate with bridge 2.7; 11 holes; 93 x 8 mm; bridge 12; stainless steel	

Straight plates Mini



standard; for screws Ø 1.5 mm; Ø 2.0 mm; Ø 2.7 mm; stainless steel

Item no.	Item description	EAN
4.410.12	straight DC-mini plate with bridge 2.7; 12 holes; 101 x 8 mm; bridge 12; stainless steel	
4.410.13	straight DC-mini plate with bridge 2.7; 13 holes; 109 x 8 mm; bridge 12; stainless steel	
4.410.14	straight DC-mini plate with bridge 2.7; 14 holes; 117 x 8 mm; bridge 12; stainless steel	
4.410.15	straight DC-mini plate with bridge 2.7; 15 holes; 125 x 8 mm; bridge 12; stainless steel	
4.410.16	straight DC-mini plate with bridge 2.7; 16 holes; 133 x 8 mm; bridge 12; stainless steel	

Straight plate Mini 2.7 DC bridge 16 – plate thickness 2.5 mm

4.410.02/St.	straight DC-mini plate with bridge 2.7; 2 holes; 25 x 8 mm; bridge 16; stainless steel	
4.410.04/St.	straight DC-mini plate with bridge 2.7; 4 holes; 41 x 8 mm; bridge 16; stainless steel	
4.410.05/St.	straight DC-mini plate with bridge 2.7; 5 holes; 49 x 8 mm; bridge 16; stainless steel	
4.410.06/St.	straight DC-mini plate with bridge 2.7; 6 holes; 57 x 8 mm; bridge 16; stainless steel	
4.410.07/St.	straight DC-mini plate with bridge 2.7; 7 holes; 65 x 8 mm; bridge 16; stainless steel	
4.410.08/St.	straight DC-mini plate with bridge 2.7; 8 holes; 73 x 8 mm; bridge 16; stainless steel	
4.410.09/St.	straight DC-mini plate with bridge 2.7; 9 holes; 81 x 8 mm; bridge 16; stainless steel	
4.410.10/St.	straight DC-mini plate with bridge 2.7; 10 holes; 89 x 8 mm; bridge 16; stainless steel	
4.410.11/St.	straight DC-mini plate with bridge 2.7; 11 holes; 97 x 8 mm; bridge 16; stainless steel	
4.410.12/St.	straight DC-mini plate with bridge 2.7; 12 holes; 105 x 8 mm; bridge 16; stainless steel	
4.410.13/St.	straight DC-mini plate with bridge 2.7; 13 holes; 113 x 8 mm; bridge 16; stainless steel	
4.410.14/St.	straight DC-mini plate with bridge 2.7; 14 holes; 121 x 8 mm; bridge 16; stainless steel	
4.410.15/St.	straight DC-mini plate with bridge 2.7; 15 holes; 129 x 8 mm; bridge 16; stainless steel	
4.410.16/St.	straight DC-mini plate with bridge 2.7; 16 holes; 137 x 8 mm; bridge 16; stainless steel	

Straight plate Mini 2.7 DC bridge 18 – plate thickness 2.5 mm

4.410.06/18	straight DC-mini plate with bridge 2.7; 6 holes; 59 x 8 mm; bridge 18; stainless steel	
4.410.07/18	straight DC-mini plate with bridge 2.7; 7 holes; 67 x 8 mm; bridge 18; stainless steel	
4.410.08/18	straight DC-mini plate with bridge 2.7; 8 holes; 75 x 8 mm; bridge 18; stainless steel	

Straight plates Mini 2.0 as

angle-stable; for screws \varnothing 2.0 mm; stainless steel











Item no. 4.9002.20



Item no. 4.4555.06



Item no. 4.470.06

Item no.	Item description	EAN
Straight plate Mini 2.0 as – plate thickness 1.5 mm		
4.9002.20	straight mini plate with conical thread 2.0; 20 holes; 119 x 5 mm; stainless steel	 4 047075 145201
Straight plate Mini 2.0 as bridge – plate thickness 2.0 mm		
4.4555.04	straight plate with conical thread and bridge 2.0; 4 holes; 27 x 5 mm; bridge 12; div.; stainless steel	 4 047075 118489
4.4555.06	straight plate with conical thread and bridge 2.0; 6 holes; 37 x 5 mm; bridge 12; div.; stainless steel	 4 047075 118496
4.4555.08	straight plate with conical thread and bridge 2.0; 8 holes; 47 x 5 mm; bridge 12; div.; stainless steel	 4 047075 117512
4.4555.10	straight plate with conical thread and bridge 2.0; 10 holes; 57 x 5 mm; bridge 12; div.; stainless steel	 4 047075 118502
Straight plate Mini 2.0 DC as bridge 16 – plate thickness 2.0 mm		
4.470.04	straight plate with conical thread and bridge 2.0; 4 holes; 31 x 5 mm; bridge 16; div.; stainless steel	 4 047075 118526
4.470.06	straight plate with conical thread and bridge 2.0; 6 holes; 41 x 5 mm; bridge 16; div.; stainless steel	 4 047075 118533
4.470.08	straight plate with conical thread and bridge 2.0; 8 holes; 51 x 5 mm; bridge 16; div.; stainless steel	 4 047075 118540
4.470.10	straight plate with conical thread and bridge 2.0; 10 holes; 61 x 5 mm; bridge 16; div.; stainless steel	 4 047075 118557

Straight plate 3.5 DC bridge 19

standard; for screws \varnothing 3.5 mm; titanium



Item no. 5.820.12

Item no.	Item description	EAN
Straight plate 3.5 DC bridge 19 – plate thickness 3.2 mm		
5.820.02	Straight DC-plate with bridge 3.5; 2 holes; 26 x 10 mm; bridge 19; titanium	4 047075 009794
5.820.03	Straight DC-plate with bridge 3.5; 3 holes; 38 x 10 mm; bridge 19; titanium	4 047075 009800
5.820.04	Straight DC-plate with bridge 3.5; 4 holes; 50 x 10 mm; bridge 19; titanium	4 047075 009817
5.820.05	Straight DC-plate with bridge 3.5; 5 holes; 62 x 10 mm; bridge 19; titanium	4 047075 009589
5.820.06	Straight DC-plate with bridge 3.5; 6 holes; 74 x 10 mm; bridge 19; titanium	4 047075 009831
5.820.07	Straight DC-plate with bridge 3.5; 7 holes; 86 x 10 mm; bridge 19; titanium	4 047075 009848
5.820.08	Straight DC-plate with bridge 3.5; 8 holes; 98 x 10 mm; bridge 19; titanium	4 047075 009695
5.820.09	Straight DC-plate with bridge 3.5; 9 holes; 110 x 10 mm; bridge 19; titanium	4 047075 009879
5.820.10	Straight DC-plate with bridge 3.5; 10 holes; 122 x 10 mm; bridge 19; titanium	4 047075 009824
5.820.11	Straight DC-plate with bridge 3.5; 11 holes; 134 x 10 mm; bridge 19; titanium	4 047075 009909
5.820.12	Straight DC-plate with bridge 3.5; 12 holes; 146 x 10 mm; bridge 19; titanium	4 047075 009916
5.820.13	Straight DC-plate with bridge 3.5; 13 holes; 158 x 10 mm; bridge 19; titanium	4 047075 009923
5.820.14	Straight DC-plate with bridge 3.5; 14 holes; 170 x 10 mm; bridge 19; titanium	4 047075 009930
5.820.15	Straight DC-plate with bridge 3.5; 15 holes; 182 x 10 mm; bridge 19; titanium	4 047075 009718
5.820.16	Straight DC-plate with bridge 3.5; 16 holes; 194 x 10 mm; bridge 19; titanium	4 047075 009725
5.820.17	Straight DC-plate with bridge 3.5; 17 holes; 206 x 10 mm; bridge 19; titanium	4 047075 009954
5.820.18	Straight DC-plate with bridge 3.5; 18 holes; 218 x 10 mm; bridge 19; titanium	4 047075 009961

Straight plates 3.5 as









angle-stable; for screws \varnothing 3.5 mm; titanium



Item no. 5.891.06



Item no. 5.896.06

Item no.	Item description	EAN
Straight plate 3.5 as bridge DC2 – plate thickness 3.5 mm		
5.891.04	with conical thread and 2 DC holes on bridge 3.5; 4 holes; 61 x 10 mm; titanium	
5.891.06	with conical thread and 2 DC holes on bridge 3.5; 6 holes; 85 x 10 mm; titanium	
5.891.08	with conical thread and 2 DC holes on bridge 3.5; 8 holes; 109 x 10 mm; titanium	
5.891.10	with conical thread and 2 DC holes on bridge 3.5; 10 holes; 133 x 10 mm; titanium	
Straight plate 3.5/4.0 as – plate thickness 3.0 mm		
5.896.04	with conic thread 3.5 and 4.0; 4 holes; 35 x 10 mm; combined holes as; titanium	
5.896.06	with conic thread 3.5 and 4.0; 6 holes; 52 x 10 mm; combined holes as; titanium	
5.896.08	with conic thread 3.5 and 4.0; 8 holes; 69 x 10 mm; combined holes as; titanium	
5.896.10	with conic thread 3.5 and 4.0; 10 holes; 86 x 10 mm; combined holes as; titanium	
5.896.12	with conic thread 3.5 and 4.0; 12 holes; 103 x 10 mm; combined holes as; titanium	

Straight plate 3.5 vas

variable angle-stable; for screws Ø 3.5 mm; titanium



Item no. 5.823.06

Item no.	Item description	EAN
Straight plate 3.5 vas – plate thickness 3.3 mm		
5.823.04	Straight plate with conical thread 3.5; 4 holes; 51 x 11 mm; vas; titanium	4 047075 116881
5.823.05	Straight plate with conical thread 3.5; 5 holes; 64 x 11 mm; vas; titanium	4 047075 116898
5.823.06	Straight plate with conical thread 3.5; 6 holes; 77 x 11 mm; vas; titanium	4 047075 116904
5.823.07	Straight plate with conical thread 3.5; 7 holes; 90 x 11 mm; vas; titanium	4 047075 116911
5.823.08	Straight plate with conical thread 3.5; 8 holes; 103 x 11 mm; vas; titanium	4 047075 116782
5.823.09	Straight plate with conical thread 3.5; 9 holes; 116 x 11 mm; vas; titanium	4 047075 117468
5.823.10	Straight plate with conical thread 3.5; 10 holes; 129 x 11 mm; vas; titanium	4 047075 116928
5.823.12	Straight plate with conical thread 3.5; 12 holes; 155 x 11 mm; vas; titanium	4 047075 116935
5.823.14	Straight plate with conical thread 3.5; 14 holes; 181 x 11 mm; vas; titanium	4 047075 116942

Straight plates 3.5























standard; for screws Ø 3.5 mm; stainless steel



Item no. 4.820.06



Item no. 4.822.08/SA





Item no.	Item description	EAN
Straight plate 3.5 DC bridge 19 – plate thickness 3.2 mm		
4.820.02	Straight DC-plate with bridge 3.5; 2 holes; 26 x 10 mm; bridge 19; stainless steel	
4.820.03	Straight DC-plate with bridge 3.5; 3 holes; 38 x 10 mm; bridge 19; stainless steel	
4.820.04	Straight DC-plate with bridge 3.5; 4 holes; 50 x 10 mm; bridge 19; stainless steel	
4.820.05	Straight DC-plate with bridge 3.5; 5 holes; 62 x 10 mm; bridge 19; stainless steel	
4.820.06	Straight DC-plate with bridge 3.5; 6 holes; 74 x 10 mm; bridge 19; stainless steel	
4.820.07	Straight DC-plate with bridge 3.5; 7 holes; 86 x 10 mm; bridge 19; stainless steel	
4.820.08	Straight DC-plate with bridge 3.5; 8 holes; 98 x 10 mm; bridge 19; stainless steel	
4.820.09	Straight DC-plate with bridge 3.5; 9 holes; 110 x 10 mm; bridge 19; stainless steel	
4.820.10	Straight DC-plate with bridge 3.5; 10 holes; 122 x 10 mm; bridge 19; stainless steel	
4.820.11	Straight DC-plate with bridge 3.5; 11 holes; 134 x 10 mm; bridge 19; stainless steel	
4.820.12	Straight DC-plate with bridge 3.5; 12 holes; 146 x 10 mm; bridge 19; stainless steel	
4.820.13	Straight DC-plate with bridge 3.5; 13 holes; 158 x 10 mm; bridge 19; stainless steel	
4.820.14	Straight DC-plate with bridge 3.5; 14 holes; 170 x 10 mm; bridge 19; stainless steel	
4.820.15	Straight DC-plate with bridge 3.5; 15 holes; 182 x 10 mm; bridge 19; stainless steel	
4.820.16	Straight DC-plate with bridge 3.5; 16 holes; 194 x 10 mm; bridge 19; stainless steel	
4.820.17	Straight DC-plate with bridge 3.5; 17 holes; 206 x 10 mm; bridge 19; stainless steel	
4.820.18	Straight DC-plate with bridge 3.5; 18 holes; 218 x 10 mm; bridge 19; stainless steel	
Straight plate 3.5 DC bridge 25 – plate thickness 3.2 mm		
4.820.06S	Straight DC-plate with bridge 3.5; 6 holes; 80 x 10 mm; bridge 25; stainless steel	
Straight plate 3.5 DC bridge 19 strong – plate thickness 4.0 mm		
4.822.06	Straight DC-plate with bridge 3.5; 6 holes; 74 x 10 mm; bridge 19; extra strong; stainless steel	
4.822.07	Straight DC-plate with bridge 3.5; 7 holes; 86 x 10 mm; bridge 19; extra strong; stainless steel	
4.822.08	Straight DC-plate with bridge 3.5; 8 holes; 98 x 10 mm; bridge 19; extra strong; stainless steel	
4.822.09	Straight DC-plate with bridge 3.5; 9 holes; 110 x 10 mm; bridge 19; extra strong; stainless steel	

Straight plates 3.5

standard; for screws Ø 3.5 mm; stainless steel

Item no.	Item description	EAN
4.822.10	Straight DC-plate with bridge 3.5; 10 holes; 122 x 10 mm; bridge 19; extra strong; stainless steel	
4.822.11	Straight DC-plate with bridge 3.5; 11 holes; 134 x 10 mm; bridge 19; extra strong; stainless steel	
4.822.12	Straight DC-plate with bridge 3.5; 12 holes; 146 x 10 mm; bridge 19; extra strong; stainless steel	
4.822.13	Straight DC-plate with bridge 3.5; 13 holes; 158 x 10 mm; bridge 19; extra strong; stainless steel	
4.822.14	Straight DC-plate with bridge 3.5; 14 holes; 170 x 10 mm; bridge 19; extra strong; stainless steel	
4.822.16	Straight DC-plate with bridge 3.5; 16 holes; 194 x 10 mm; bridge 19; extra strong; stainless steel	
4.822.18	Straight DC-plate with bridge 3.5; 18 holes; 218 x 10 mm; bridge 19; extra strong; stainless steel	
4.822.20	Straight DC-plate with bridge 3.5; 20 holes; 242 x 10 mm; bridge 19; extra strong; stainless steel	
4.822.22	Straight DC-plate with bridge 3.5; 22 holes; 266 x 10 mm; bridge 19; extra strong; stainless steel	

Straight plate 3.5 DC bridge 45 strong – plate thickness 4.0 mm





4.822.08/SA	Straight DC-plate with bridge 3.5; 8 holes; 126 x 10 mm; bridge 45; extra strong; stainless steel	
4.822.09/SA	Straight DC-plate with bridge 3.5; 9 holes; 138 x 10 mm; bridge 45; extra strong; stainless steel	
4.822.10/SA	Straight DC-plate with bridge 3.5; 10 holes; 150 x 10 mm; bridge 45; extra strong; stainless steel	
4.822.12/SA	Straight DC-plate with bridge 3.5; 12 holes; 174 x 10 mm; bridge 45; extra strong; stainless steel	

Straight plate 3.5 as DC bridge

angle-stable; for screws \varnothing 3.5 mm; stainless steel



Item no. 4.472.06

Item no.	Item description	EAN
Straight plate 3.5 as DC bridge – plate thickness 3.0 mm		
4.472.04	Straight plate with conic thread and bridge 3.5; 4 holes; 71 x 10 mm; bridge 35; stainless steel	
4.472.06	Straight plate with conic thread and bridge 3.5; 6 holes; 95 x 10 mm; bridge 35; stainless steel	
4.472.08	Straight plate with conic thread and bridge 3.5; 8 holes; 119 x 10 mm; bridge 35; stainless steel	
4.472.10	Straight plate with conic thread and bridge 3.5; 10 holes; 143 x 10 mm; bridge 35; stainless steel	

Straight plates 4.5

standard; for screws \varnothing 4.5 mm; titanium











Item no. 5.530.10



Item no. 5.540.10

Item no.	Item description	EAN
----------	------------------	-----

Straight plate 4.5/6.5 DC narrow – plate thickness 4.2 mm

5.530.05	Straight DC-plate 4.5 and 6.5; 5 holes; 87 x 12 mm; narrow; titanium	
5.530.06	Straight DC-plate 4.5 and 6.5; 6 holes; 103 x 12 mm; narrow; titanium	
5.530.07	Straight DC-plate 4.5 and 6.5; 7 holes; 119 x 12 mm; narrow; titanium	
5.530.08	Straight DC-plate 4.5 and 6.5; 8 holes; 135 x 12 mm; narrow; titanium	
5.530.09	Straight DC-plate 4.5 and 6.5; 9 holes; 151 x 12 mm; narrow; titanium	
5.530.10	Straight DC-plate 4.5 and 6.5; 10 holes; 167 x 12 mm; narrow; titanium	
5.530.11	Straight DC-plate 4.5 and 6.5; 11 holes; 183 x 12 mm; narrow; titanium	
5.530.12	Straight DC-plate 4.5 and 6.5; 12 holes; 199 x 12 mm; narrow; titanium	
5.530.18	Straight DC-plate 4.5 and 6.5; 18 holes; 295 x 12 mm; narrow; titanium	

Straight plate 4.5/6.5 DC broad – plate thickness 5.2 mm

5.540.08	Straight DC-plate 4.5 and 6.5; 8 holes; 135 x 16 mm; broad; staggered holes; titanium	
5.540.09	Straight DC-plate 4.5 and 6.5; 9 holes; 151 x 16 mm; broad; staggered holes; titanium	
5.540.10	Straight DC-plate 4.5 and 6.5; 10 holes; 167 x 16 mm; broad; staggered holes; titanium	
5.540.11	Straight DC-plate 4.5 and 6.5; 11 holes; 183 x 16 mm; broad; staggered holes; titanium	
5.540.12	Straight DC-plate 4.5 and 6.5; 12 holes; 199 x 16 mm; broad; staggered holes; titanium	
5.540.13	Straight DC-plate 4.5 and 6.5; 13 holes; 215 x 16 mm; broad; staggered holes; titanium	
5.540.14	Straight DC-plate 4.5 and 6.5; 14 holes; 231 x 16 mm; broad; staggered holes; titanium	
5.540.15	Straight DC-plate 4.5 and 6.5; 15 holes; 247 x 16 mm; broad; staggered holes; titanium	
5.540.16	Straight DC-plate 4.5 and 6.5; 16 holes; 263 x 16 mm; broad; staggered holes; titanium	
5.540.18	Straight DC-plate 4.5 and 6.5; 18 holes; 295 x 16 mm; broad; staggered holes; titanium	
5.540.20	Straight DC-plate 4.5 and 6.5; 20 holes; 327 x 16 mm; broad; staggered holes; titanium	
5.540.22	Straight DC-plate 4.5 and 6.5; 22 holes; 359 x 16 mm; broad; staggered holes; titanium	
5.540.24	Straight DC-plate 4.5 and 6.5; 24 holes; 391 x 16 mm; broad; staggered holes; titanium	
5.540.26	Straight DC-plate 4.5 and 6.5; 26 holes; 423 x 16 mm; broad; staggered holes; titanium	



Königsee Implantate GmbH
 OT Aschau | Am Sand 4
 07426 Allendorf | Germany

Fon +49 36738 498-560
 Fax +49 36738 498-569

Mail export@koenigsee-implantate.de

For further information please visit:
www.koenigsee-implantate.com

KrMo | Edition 01 | 2020-09
 All pictured products are CE compliant.

Straight plates 4.5

standard; for screws Ø 4.5 mm; stainless steel







Item no. 4.530.06







Item no. 4.540.08

Item no.	Item description	EAN
----------	------------------	-----

Straight plate 4.5/6.5 DC narrow – plate thickness 4.0 mm

4.530.02	Straight DC-plate 4.5 and 6.5; 2 holes; 39 x 12 mm; narrow; stainless steel	
4.530.03	Straight DC-plate 4.5 and 6.5; 3 holes; 55 x 12 mm; narrow; stainless steel	
4.530.04	Straight DC-plate 4.5 and 6.5; 4 holes; 71 x 12 mm; narrow; stainless steel	
4.530.05	Straight DC-plate 4.5 and 6.5; 5 holes; 87 x 12 mm; narrow; stainless steel	
4.530.06	Straight DC-plate 4.5 and 6.5; 6 holes; 103 x 12 mm; narrow; stainless steel	
4.530.07	Straight DC-plate 4.5 and 6.5; 7 holes; 119 x 12 mm; narrow; stainless steel	
4.530.08	Straight DC-plate 4.5 and 6.5; 8 holes; 135 x 12 mm; narrow; stainless steel	
4.530.09	Straight DC-plate 4.5 and 6.5; 9 holes; 151 x 12 mm; narrow; stainless steel	
4.530.10	Straight DC-plate 4.5 and 6.5; 10 holes; 167 x 12 mm; narrow; stainless steel	
4.530.11	Straight DC-plate 4.5 and 6.5; 11 holes; 183 x 12 mm; narrow; stainless steel	
4.530.12	Straight DC-plate 4.5 and 6.5; 12 holes; 199 x 12 mm; narrow; stainless steel	
4.530.13	Straight DC-plate 4.5 and 6.5; 13 holes; 215 x 12 mm; narrow; stainless steel	
4.530.14	Straight DC-plate 4.5 and 6.5; 14 holes; 231 x 12 mm; narrow; stainless steel	
4.530.15	Straight DC-plate 4.5 and 6.5; 15 holes; 247 x 12 mm; narrow; stainless steel	
4.530.16	Straight DC-plate 4.5 and 6.5; 16 holes; 263 x 12 mm; narrow; stainless steel	
4.530.17	Straight DC-plate 4.5 and 6.5; 17 holes; 279 x 12 mm; narrow; stainless steel	
4.530.18	Straight DC-plate 4.5 and 6.5; 18 holes; 295 x 12 mm; narrow; stainless steel	

Straight plate 4.5/6.5 DC broad – plate thickness 5.1 mm

4.540.03	Straight DC-plate 4.5 and 6.5; 3 holes; 55 x 16 mm; broad; staggered holes; stainless steel	
4.540.04	Straight DC-plate 4.5 and 6.5; 4 holes; 71 x 16 mm; broad; staggered holes; stainless steel	
4.540.05	Straight DC-plate 4.5 and 6.5; 5 holes; 87 x 16 mm; broad; staggered holes; stainless steel	
4.540.06	Straight DC-plate 4.5 and 6.5; 6 holes; 103 x 16 mm; broad; staggered holes; stainless steel	
4.540.07	Straight DC-plate 4.5 and 6.5; 7 holes; 119 x 16 mm; broad; staggered holes; stainless steel	
4.540.08	Straight DC-plate 4.5 and 6.5; 8 holes; 135 x 16 mm; broad; staggered holes; stainless steel	
4.540.09	Straight DC-plate 4.5 and 6.5; 9 holes; 151 x 16 mm; broad; staggered holes; stainless steel	



Königsee Implantate GmbH
 OT Aschau | Am Sand 4
 07426 Allendorf | Germany

Fon +49 36738 498-560
 Fax +49 36738 498-569











Mail export@koenigsee-implantate.de

For further information please visit:
www.koenigsee-implantate.com

KrMo | Edition 01 | 2020-09
 All pictured products are CE compliant.

Straight plates 4.5

standard; for screws Ø 4.5 mm; stainless steel

Item no.	Item description	EAN
4.540.10	Straight DC-plate 4.5 and 6.5; 10 holes; 167 x 16 mm; broad; staggered holes; stainless steel	 4 047075 108046
4.540.11	Straight DC-plate 4.5 and 6.5; 11 holes; 183 x 16 mm; broad; staggered holes; stainless steel	 4 047075 107940
4.540.12	Straight DC-plate 4.5 and 6.5; 12 holes; 199 x 16 mm; broad; staggered holes; stainless steel	 4 047075 108138
4.540.13	Straight DC-plate 4.5 and 6.5; 13 holes; 215 x 16 mm; broad; staggered holes; stainless steel	 4 047075 108145
4.540.14	Straight DC-plate 4.5 and 6.5; 14 holes; 231 x 16 mm; broad; staggered holes; stainless steel	 4 047075 108022
4.540.15	Straight DC-plate 4.5 and 6.5; 15 holes; 247 x 16 mm; broad; staggered holes; stainless steel	 4 047075 108039
4.540.16	Straight DC-plate 4.5 and 6.5; 16 holes; 263 x 16 mm; broad; staggered holes; stainless steel	 4 047075 108053
4.540.17	Straight DC-plate 4.5 and 6.5; 17 holes; 279 x 16 mm; broad; staggered holes; stainless steel	 4 047075 108060
4.540.18	Straight DC-plate 4.5 and 6.5; 18 holes; 295 x 16 mm; broad; staggered holes; stainless steel	 4 047075 108077
4.540.20	Straight DC-plate 4.5 and 6.5; 20 holes; 327 x 16 mm; broad; staggered holes; stainless steel	 4 047075 108084
4.540.21	Straight DC-plate 4.5 and 6.5; 21 holes; 343 x 16 mm; broad; staggered holes; stainless steel	 4 047075 108152
4.540.22	Straight DC-plate 4.5 and 6.5; 22 holes; 359 x 16 mm; broad; staggered holes; stainless steel	 4 047075 108282

Straight plates 4.5 as

angle-stable; for screws \varnothing 4.5 mm; stainless steel



Item no. 4.444.08



Item no. 4.445.08









Item no. 4.4445.08









Item no. 4.446.10

Item no.	Item description	EAN
----------	------------------	-----







Straight plate 4.5 as bridge 40 – plate thickness 4.0 mm

4.444.02	with conical thread and bridge 4.5; 2 holes; 52 x 12 mm; bridge 40; stainless steel	
4.444.04	with conical thread and bridge 4.5; 4 holes; 76 x 12 mm; bridge 40; stainless steel	
4.444.06	with conical thread and bridge 4.5; 6 holes; 100 x 12 mm; bridge 40; stainless steel	
4.444.08	with conical thread and bridge 4.5; 8 holes; 124 x 12 mm; bridge 40; stainless steel	
4.444.14	with conical thread and bridge 4.5; 14 holes; 196 x 12 mm; bridge 40; stainless steel	
4.444.16	with conical thread and bridge 4.5; 16 holes; 220 x 12 mm; bridge 40; stainless steel	



Straight plate 4.5 as bridge 40 divergent – plate thickness 4.0 mm

4.4445.02	with conical thread and bridge 4.5; 2 holes; 52 x 12 mm; bridge 40; diverging; stainless steel	
4.4445.04	with conical thread and bridge 4.5; 4 holes; 76 x 12 mm; bridge 40; diverging; stainless steel	
4.4445.06	with conical thread and bridge 4.5; 6 holes; 100 x 12 mm; bridge 40; diverging; stainless steel	
4.4445.08	with conical thread and bridge 4.5; 8 holes; 124 x 12 mm; bridge 40; diverging; stainless steel	
4.4445.10	with conical thread and bridge 4.5; 10 holes; 148 x 12 mm; bridge 40; diverging; stainless steel	
4.4445.12	with conical thread and bridge 4.5; 12 holes; 172 x 12 mm; bridge 40; diverging; stainless steel	

Straight plate 4.5 as – plate thickness 4.0 mm

4.445.04	with conical thread 4.5; 4 holes; 48 x 12 mm; stainless steel	
4.445.05	with conical thread 4.5; 5 holes; 60 x 12 mm; stainless steel	
4.445.06	with conical thread 4.5; 6 holes; 72 x 12 mm; stainless steel	
4.445.08	with conical thread 4.5; 8 holes; 96 x 12 mm; stainless steel	
4.445.12	with conical thread 4.5; 12 holes; 144 x 12 mm; stainless steel	
4.445.16	with conical thread 4.5; 16 holes; 192 x 12 mm; stainless steel	

Straight plate 4.5 as divergent – plate thickness 4.0 mm

4.4455.02	with conical thread 4.5; 2 holes; 24 x 12 mm; screws diverging; stainless steel	
4.4455.04	with conical thread 4.5; 4 holes; 48 x 12 mm; screws diverging; stainless steel	



Königsee Implantate GmbH
 OT Aschau | Am Sand 4
 07426 Allendorf | Germany

Fon +49 36738 498-560
 Fax +49 36738 498-569

Mail export@koenigsee-implantate.de

For further information please visit:
www.koenigsee-implantate.com



KrMo | Edition 01 | 2020-09
 All pictured products are CE compliant.

Straight plates 4.5 as





angle-stable; for screws \varnothing 4.5 mm; stainless steel

Item no.	Item description	EAN
4.4455.05	with conical thread 4.5; 5 holes; 60 x 12 mm; screws diverging; stainless steel	 4 047075 118991
4.4455.06	with conical thread 4.5; 6 holes; 72 x 12 mm; screws diverging; stainless steel	 4 047075 119004
4.4455.08	with conical thread 4.5; 8 holes; 96 x 12 mm; screws diverging; stainless steel	 4 047075 117482
4.4455.10	with conical thread 4.5; 10 holes; 120 x 12 mm; screws diverging; stainless steel	 4 047075 119011
4.4455.12	with conical thread 4.5; 12 holes; 144 x 12 mm; screws diverging; stainless steel	 4 047075 119028
4.4455.14	with conical thread 4.5; 14 holes; 168 x 12 mm; screws diverging; stainless steel	 4 047075 119035
4.4455.16	with conical thread 4.5; 16 holes; 192 x 12 mm; screws diverging; stainless steel	 4 047075 119042

Straight plate 4.5 as bridge – plate thickness 5.0 mm

4.446.10	with conical thread and bridge 4.5; 10 holes; 148 x 16 mm; bridge 40; stainless steel	 4 047075 106837
4.446.12	with conical thread and bridge 4.5; 12 holes; 172 x 16 mm; bridge 40; stainless steel	 4 047075 106981

Straight plate 4.5 as DC bridge – plate thickness 4.0 mm

4.473.04	with conic thread and bridge 4.5; 4 holes; 91 x 12 mm; bridge 55; stainless steel	 4 047075 118922
4.473.06	with conic thread and bridge 4.5; 6 holes; 115 x 12 mm; bridge 55; stainless steel	 4 047075 118939
4.473.08	with conic thread and bridge 4.5; 8 holes; 139 x 12 mm; bridge 55; stainless steel	 4 047075 118946
4.473.10	with conic thread and bridge 4.5; 10 holes; 163 x 12 mm; bridge 55; stainless steel	 4 047075 118953
4.473.12	with conic thread and bridge 4.5; 12 holes; 187 x 12 mm; bridge 55; stainless steel	 4 047075 118960

Reco plates Mini 2.7

standard; for screws \varnothing 2.7 mm; titanium



Item no. 5.302.10

Item no.	Item description	EAN
Reco plate Mini 2.7 – plate thickness 2.2 mm		
5.302.04	mini reco-plate 2.7; 4 holes; 32 x 8 mm; straight; titanium	4 047075 003617
5.302.05	mini reco-plate 2.7; 5 holes; 40 x 8 mm; straight; titanium	4 047075 003679
5.302.06	mini reco-plate 2.7; 6 holes; 48 x 8 mm; straight; titanium	4 047075 003686
5.302.08	mini reco-plate 2.7; 8 holes; 64 x 8 mm; straight; titanium	4 047075 003693
5.302.10	mini reco-plate 2.7; 10 holes; 80 x 8 mm; straight; titanium	4 047075 003709
5.302.12	mini reco-plate 2.7; 12 holes; 96 x 8 mm; straight; titanium	4 047075 003495
5.302.14	mini reco-plate 2.7; 14 holes; 112 x 8 mm; straight; titanium	4 047075 003723
5.302.16	mini reco-plate 2.7; 16 holes; 128 x 8 mm; straight; titanium	4 047075 003730
5.302.18	mini reco-plate 2.7; 18 holes; 144 x 8 mm; straight; titanium	4 047075 003747
5.302.20	mini reco-plate 2.7; 20 holes; 160 x 8 mm; straight; titanium	4 047075 003754
5.302.22	mini reco-plate 2.7; 22 holes; 176 x 8 mm; straight; titanium	4 047075 003716
5.302.24	mini reco-plate 2.7; 24 holes; 192 x 8 mm; straight; titanium	4 047075 003785
Reco plate Mini 2.7 undercut – plate thickness 3.0 mm		
5.303.04	mini reco-plate 2.7; 4 holes; 32 x 8 mm; straight; undercut; titanium	4 047075 003792
5.303.05	mini reco-plate 2.7; 5 holes; 40 x 8 mm; straight; undercut; titanium	4 047075 003808
5.303.06	mini reco-plate 2.7; 6 holes; 48 x 8 mm; straight; undercut; titanium	4 047075 003815
5.303.08	mini reco-plate 2.7; 8 holes; 64 x 8 mm; straight; undercut; titanium	4 047075 003600
5.303.10	mini reco-plate 2.7; 10 holes; 80 x 8 mm; straight; undercut; titanium	4 047075 003778
5.303.12	mini reco-plate 2.7; 12 holes; 96 x 8 mm; straight; undercut; titanium	4 047075 003839
5.303.14	mini reco-plate 2.7; 14 holes; 112 x 8 mm; straight; undercut; titanium	4 047075 003846
5.303.16	mini reco-plate 2.7; 16 holes; 128 x 8 mm; straight; undercut; titanium	4 047075 003853
5.303.18	mini reco-plate 2.7; 18 holes; 144 x 8 mm; straight; undercut; titanium	4 047075 003860
5.303.20	mini reco-plate 2.7; 20 holes; 160 x 8 mm; straight; undercut; titanium	4 047075 003662
5.303.22	mini reco-plate 2.7; 22 holes; 176 x 8 mm; straight; undercut; titanium	4 047075 003884
5.303.24	mini reco-plate 2.7; 24 holes; 192 x 8 mm; straight; undercut; titanium	4 047075 003891

Reco plate Mini 2.7 vas

variable angle-stable; for screws Ø 2.7 mm; titanium



Item no. 5.3023.07

Item no.	Item description	EAN
Reco plate Mini 2.7 vas – plate thickness 2.2 mm		
5.3023.04	reco-plate 2.7; 4 holes; 32 x 8 mm; straight; a.s.v.; titanium	4 047075 158676
5.3023.05	reco-plate 2.7; 5 holes; 40 x 8 mm; straight; a.s.v.; titanium	4 047075 158683
5.3023.06	reco-plate 2.7; 6 holes; 48 x 8 mm; straight; a.s.v.; titanium	4 047075 158690
5.3023.07	reco-plate 2.7; 7 holes; 56 x 8 mm; straight; a.s.v.; titanium	4 047075 158706
5.3023.08	reco-plate 2.7; 8 holes; 64 x 8 mm; straight; a.s.v.; titanium	4 047075 158713
5.3023.16	reco-plate 2.7; 16 holes; 128 x 8 mm; straight; a.s.v.; titanium	4 047075 165544

Reco plates Mini 2.7

standard; for screws Ø 2.7 mm; stainless steel



Item no. 4.302.10



Item no. 4.303.10

Item no.	Item description	EAN
Reco plate Mini 2.7 – plate thickness 2.2 mm		
4.302.04	mini reco-plate 2.7; 4 holes; 32 x 8 mm; straight; stainless steel	4 047075 103430
4.302.05	mini reco-plate 2.7; 5 holes; 40 x 8 mm; straight; stainless steel	4 047075 103447
4.302.06	mini reco-plate 2.7; 6 holes; 48 x 8 mm; straight; stainless steel	4 047075 103454
4.302.07	mini reco-plate 2.7; 7 holes; 56 x 8 mm; straight; stainless steel	4 047075 103331
4.302.08	mini reco-plate 2.7; 8 holes; 64 x 8 mm; straight; stainless steel	4 047075 103348
4.302.09	mini reco-plate 2.7; 9 holes; 72 x 8 mm; straight; stainless steel	4 047075 103355
4.302.10	mini reco-plate 2.7; 10 holes; 80 x 8 mm; straight; stainless steel	4 047075 103362
4.302.12	mini reco-plate 2.7; 12 holes; 96 x 8 mm; straight; stainless steel	4 047075 103522
4.302.14	mini reco-plate 2.7; 14 holes; 112 x 8 mm; straight; stainless steel	4 047075 103539
4.302.16	mini reco-plate 2.7; 16 holes; 128 x 8 mm; straight; stainless steel	4 047075 103461
4.302.18	mini reco-plate 2.7; 18 holes; 144 x 8 mm; straight; stainless steel	4 047075 103560
4.302.20	mini reco-plate 2.7; 20 holes; 160 x 8 mm; straight; stainless steel	4 047075 103478
4.302.22	mini reco-plate 2.7; 22 holes; 176 x 8 mm; straight; stainless steel	4 047075 103485
4.302.24	mini reco-plate 2.7; 24 holes; 192 x 8 mm; straight; stainless steel	4 047075 103492
Reco plate Mini 2.7 undercut – plate thickness 2.2 mm		
4.303.04	mini reco-plate 2.7; 4 holes; 32 x 8 mm; straight; undercut; stainless steel	4 047075 103553
4.303.05	mini reco-plate 2.7; 5 holes; 40 x 8 mm; straight; undercut; stainless steel	4 047075 103690
4.303.06	mini reco-plate 2.7; 6 holes; 48 x 8 mm; straight; undercut; stainless steel	4 047075 103577
4.303.08	mini reco-plate 2.7; 8 holes; 64 x 8 mm; straight; undercut; stainless steel	4 047075 103584
4.303.10	mini reco-plate 2.7; 10 holes; 80 x 8 mm; straight; undercut; stainless steel	4 047075 103591
4.303.12	mini reco-plate 2.7; 12 holes; 96 x 8 mm; straight; undercut; stainless steel	4 047075 103508
4.303.14	mini reco-plate 2.7; 14 holes; 112 x 8 mm; straight; undercut; stainless steel	4 047075 103621
4.303.16	mini reco-plate 2.7; 16 holes; 128 x 8 mm; straight; undercut; stainless steel	4 047075 103515
4.303.18	mini reco-plate 2.7; 18 holes; 144 x 8 mm; straight; undercut; stainless steel	4 047075 103713
4.303.20	mini reco-plate 2.7; 20 holes; 160 x 8 mm; straight; undercut; stainless steel	4 047075 103720
4.303.22	mini reco-plate 2.7; 22 holes; 176 x 8 mm; straight; undercut; stainless steel	4 047075 103607
4.303.24	mini reco-plate 2.7; 24 holes; 192 x 8 mm; straight; undercut; stainless steel	4 047075 103614

Reco plates 3.5

standard; for screws \varnothing 3.5 mm; titanium



Item no. 5.313.06



Item no. 5.328.06



Item no. 5.861.04

Item no.	Item description	EAN
----------	------------------	-----

Reco plate 3.5 – plate thickness 2.2 mm

















5.312.04	reco-plate 3.5; 4 holes; 46 x 10 mm; straight; titanium	4 047075 003945
5.312.05	reco-plate 3.5; 5 holes; 58 x 10 mm; straight; titanium	4 047075 003952
5.312.06	reco-plate 3.5; 6 holes; 70 x 10 mm; straight; titanium	4 047075 003969
5.312.07	reco-plate 3.5; 7 holes; 82 x 10 mm; straight; titanium	4 047075 003976
5.312.08	reco-plate 3.5; 8 holes; 94 x 10 mm; straight; titanium	4 047075 003761
5.312.09	reco-plate 3.5; 9 holes; 106 x 10 mm; straight; titanium	4 047075 003938
5.312.10	reco-plate 3.5; 10 holes; 118 x 10 mm; straight; titanium	4 047075 003990
5.312.12	reco-plate 3.5; 12 holes; 142 x 10 mm; straight; titanium	4 047075 004003
5.312.14	reco-plate 3.5; 14 holes; 166 x 10 mm; straight; titanium	4 047075 004010
5.312.16	reco-plate 3.5; 16 holes; 190 x 10 mm; straight; titanium	4 047075 004027
5.312.18	reco-plate 3.5; 18 holes; 214 x 10 mm; straight; titanium	4 047075 003822
5.312.20	reco-plate 3.5; 20 holes; 238 x 10 mm; straight; titanium	4 047075 004041
5.312.22	reco-plate 3.5; 22 holes; 262 x 10 mm; straight; titanium	4 047075 004058

Reco plate 3.5 strong – plate thickness 3.2 mm

5.313.04	reco-plate 3.5; 4 holes; 46 x 10 mm; straight; strong; titanium	4 047075 004065
5.313.05	reco-plate 3.5; 5 holes; 58 x 10 mm; straight; strong; titanium	4 047075 004072
5.313.06	reco-plate 3.5; 6 holes; 70 x 10 mm; straight; strong; titanium	4 047075 004034
5.313.07	reco-plate 3.5; 7 holes; 82 x 10 mm; straight; strong; titanium	4 047075 004102
5.313.08	reco-plate 3.5; 8 holes; 94 x 10 mm; straight; strong; titanium	4 047075 004119
5.313.09	reco-plate 3.5; 9 holes; 106 x 10 mm; straight; strong; titanium	4 047075 004126
5.313.10	reco-plate 3.5; 10 holes; 118 x 10 mm; straight; strong; titanium	4 047075 004133
5.313.12	reco-plate 3.5; 12 holes; 142 x 10 mm; straight; strong; titanium	4 047075 003921
5.313.14	reco-plate 3.5; 14 holes; 166 x 10 mm; straight; strong; titanium	4 047075 004096
5.313.16	reco-plate 3.5; 16 holes; 190 x 10 mm; straight; strong; titanium	4 047075 004157
5.313.18	reco-plate 3.5; 18 holes; 214 x 10 mm; straight; strong; titanium	4 047075 004164

Reco plates 3.5

standard; for screws \varnothing 3.5 mm; titanium

Item no.	Item description	EAN
5.313.20	reco-plate 3.5; 20 holes; 238 x 10 mm; straight; strong; titanium	 4 047075 004171
5.313.22	reco-plate 3.5; 22 holes; 262 x 10 mm; straight; strong; titanium	 4 047075 004188
Reco plate 3.5 bent – plate thickness 2.6 mm		
5.328.04	reco-plate 3.5; 4 holes; breadth 10 mm; arcuate; titanium	 4 047075 062003
5.328.05	reco-plate 3.5; 5 holes; breadth 10 mm; arcuate; titanium	 4 047075 004393
5.328.06	reco-plate 3.5; 6 holes; breadth 10 mm; arcuate; titanium	 4 047075 004225
5.328.08	reco-plate 3.5; 8 holes; breadth 10 mm; arcuate; titanium	 4 047075 004409
5.328.10	reco-plate 3.5; 10 holes; breadth 10 mm; arcuate; titanium	 4 047075 004416
5.328.12	reco-plate 3.5; 12 holes; breadth 10 mm; arcuate; titanium	 4 047075 062010
5.328.14	reco-plate 3.5; 14 holes; breadth 10 mm; arcuate; titanium	 4 047075 062027
Distal humerus plate Y 3.5 Reco – plate thickness 2.2 mm		
5.861.03	Y-reco plate for distal humerus 3.5; 3 holes; breadth 10 mm; titanium	 4 047075 010455
5.861.04	Y-reco plate for distal humerus 3.5; 4 holes; breadth 10 mm; titanium	 4 047075 010462
5.861.05	Y-reco plate for distal humerus 3.5; 5 holes; breadth 10 mm; titanium	 4 047075 010479
5.861.06	Y-reco plate for distal humerus 3.5; 6 holes; breadth 10 mm; titanium	 4 047075 010486
5.861.07	Y-reco plate for distal humerus 3.5; 7 holes; breadth 10 mm; titanium	 4 047075 010271
5.861.08	Y-reco plate for distal humerus 3.5; 8 holes; breadth 10 mm; titanium	 4 047075 010516
5.861.16	Y-reco plate for distal humerus 3.5; 16 holes; breadth 10 mm; titanium	 4 047075 010523

Reco plate 3.5 vas strong

variable angle-stable; for screws Ø 3.5 mm; titanium



Item no. 5.3133.06

Item no.	Item description	EAN
Reco plate 3.5 vas strong – plate thickness 3.0 mm		
5.3133.04	reco-plate with conic thread 3.5; 4 holes; 46 x 10 mm; straight; strong; ang.stab.var; titanium	4 047075 114888
5.3133.05	reco-plate with conic thread 3.5; 5 holes; 58 x 10 mm; straight; strong; ang.stab.var; titanium	4 047075 114559
5.3133.06	reco-plate with conic thread 3.5; 6 holes; 70 x 10 mm; straight; strong; ang.stab.var; titanium	4 047075 114498
5.3133.07	reco-plate with conic thread 3.5; 7 holes; 82 x 10 mm; straight; strong; ang.stab.var; titanium	4 047075 114504
5.3133.08	reco-plate with conic thread 3.5; 8 holes; 94 x 10 mm; straight; strong; ang.stab.var; titanium	4 047075 114511
5.3133.09	reco-plate with conic thread 3.5; 9 holes; 106 x 10 mm; straight; strong; ang.stab.var; titanium	4 047075 117475
5.3133.10	reco-plate with conic thread 3.5; 10 holes; 118 x 10 mm; straight; strong; ang.stab.var; titanium	4 047075 116119
5.3133.11	reco-plate with conic thread 3.5; 11 holes; 130 x 10 mm; straight; strong; ang.stab.var; titanium	4 047075 120864
5.3133.12	reco-plate with conic thread 3.5; 12 holes; 142 x 10 mm; straight; strong; ang.stab.var; titanium	4 047075 116126
5.3133.14	reco-plate with conic thread 3.5; 14 holes; 166 x 10 mm; straight; strong; ang.stab.var; titanium	4 047075 128884
5.3133.16	reco-plate with conic thread 3.5; 16 holes; 190 x 10 mm; straight; strong; ang.stab.var; titanium	4 047075 150090
5.3133.18	reco-plate with conic thread 3.5; 18 holes; 214 x 10 mm; straight; strong; ang.stab.var; titanium	4 047075 150106
5.3133.20	reco-plate with conic thread 3.5; 20 holes; 238 x 10 mm; straight; strong; ang.stab.var; titanium	4 047075 150113

Reco plates 3.5

standard; for screws Ø 3.5 mm; stainless steel



Item no. 4.312.06



Item no. 4.313.06







Item no. 4.328.06

Item no.	Item description	EAN
----------	------------------	-----

Reco plate 3.5 – plate thickness 2.6 mm

4.312.03	reco-plate 3.5; 3 holes; 34 x 10 mm; straight; stainless steel	
4.312.04	reco-plate 3.5; 4 holes; 46 x 10 mm; straight; stainless steel	
4.312.05	reco-plate 3.5; 5 holes; 58 x 10 mm; straight; stainless steel	
4.312.06	reco-plate 3.5; 6 holes; 70 x 10 mm; straight; stainless steel	
4.312.07	reco-plate 3.5; 7 holes; 82 x 10 mm; straight; stainless steel	
4.312.08	reco-plate 3.5; 8 holes; 94 x 10 mm; straight; stainless steel	
4.312.09	reco-plate 3.5; 9 holes; 106 x 10 mm; straight; stainless steel	
4.312.10	reco-plate 3.5; 10 holes; 118 x 10 mm; straight; stainless steel	
4.312.11	reco-plate 3.5; 11 holes; 130 x 10 mm; straight; stainless steel	
4.312.12	reco-plate 3.5; 12 holes; 142 x 10 mm; straight; stainless steel	
4.312.13	reco-plate 3.5; 13 holes; 154 x 10 mm; straight; stainless steel	
4.312.14	reco-plate 3.5; 14 holes; 166 x 10 mm; straight; stainless steel	
4.312.15	reco-plate 3.5; 15 holes; 178 x 10 mm; straight; stainless steel	
4.312.16	reco-plate 3.5; 16 holes; 190 x 10 mm; straight; stainless steel	
4.312.17	reco-plate 3.5; 17 holes; 202 x 10 mm; straight; stainless steel	
4.312.18	reco-plate 3.5; 18 holes; 214 x 10 mm; straight; stainless steel	
4.312.19	reco-plate 3.5; 19 holes; 226 x 10 mm; straight; stainless steel	
4.312.20	reco-plate 3.5; 20 holes; 238 x 10 mm; straight; stainless steel	
4.312.22	reco-plate 3.5; 22 holes; 262 x 10 mm; straight; stainless steel	

Reco plate 3.5 strong – plate thickness 3.2 mm

4.313.04	reco-plate 3.5; 4 holes; 46 x 10 mm; straight; strong; stainless steel	
4.313.05	reco-plate 3.5; 5 holes; 58 x 10 mm; straight; strong; stainless steel	
4.313.06	reco-plate 3.5; 6 holes; 70 x 10 mm; straight; strong; stainless steel	
4.313.07	reco-plate 3.5; 7 holes; 82 x 10 mm; straight; strong; stainless steel	
4.313.08	reco-plate 3.5; 8 holes; 94 x 10 mm; straight; strong; stainless steel	



Königsee Implantate GmbH
 OT Aschau | Am Sand 4
 07426 Allendorf | Germany

Fon +49 36738 498-560
 Fax +49 36738 498-569

Mail export@koenigsee-implantate.de

For further information please visit:
www.koenigsee-implantate.com





KrMo | Edition 02 | 2020-09
 All pictured products are CE compliant.

Reco plates 3.5

standard; for screws Ø 3.5 mm; stainless steel

Item no.	Item description	EAN
4.313.09	reco-plate 3.5; 9 holes; 106 x 10 mm; straight; strong; stainless steel	 4 047075 103867
4.313.10	reco-plate 3.5; 10 holes; 118 x 10 mm; straight; strong; stainless steel	 4 047075 103874
4.313.11	reco-plate 3.5; 11 holes; 130 x 10 mm; straight; strong; stainless steel	 4 047075 118311
4.313.12	reco-plate 3.5; 12 holes; 142 x 10 mm; straight; strong; stainless steel	 4 047075 104048
4.313.13	reco-plate 3.5; 13 holes; 154 x 10 mm; straight; strong; stainless steel	 4 047075 104055
4.313.14	reco-plate 3.5; 14 holes; 166 x 10 mm; straight; strong; stainless steel	 4 047075 103966
4.313.15	reco-plate 3.5; 15 holes; 178 x 10 mm; straight; strong; stainless steel	 4 047075 118328
4.313.16	reco-plate 3.5; 16 holes; 190 x 10 mm; straight; strong; stainless steel	 4 047075 104079
4.313.17	reco-plate 3.5; 17 holes; 202 x 10 mm; straight; strong; stainless steel	 4 047075 118335
4.313.18	reco-plate 3.5; 18 holes; 214 x 10 mm; straight; strong; stainless steel	 4 047075 103973
4.313.19	reco-plate 3.5; 19 holes; 226 x 10 mm; straight; strong; stainless steel	 4 047075 118342
4.313.20	reco-plate 3.5; 20 holes; 238 x 10 mm; straight; strong; stainless steel	 4 047075 103980
4.313.22	reco-plate 3.5; 22 holes; 262 x 10 mm; straight; strong; stainless steel	 4 047075 103997

Reco plate 3.5 bent – plate thickness 2.6 mm

4.328.03	reco-plate 3.5; 3 holes; breadth 10; arcuate; stainless steel	 4 047075 104192
4.328.04	reco-plate 3.5; 4 holes; breadth 10; arcuate; stainless steel	 4 047075 104369
4.328.05	reco-plate 3.5; 5 holes; breadth 10; arcuate; stainless steel	 4 047075 104376
4.328.06	reco-plate 3.5; 6 holes; breadth 10; arcuate; stainless steel	 4 047075 104277
4.328.07	reco-plate 3.5; 7 holes; breadth 10; arcuate; stainless steel	 4 047075 104383
4.328.08	reco-plate 3.5; 8 holes; breadth 10; arcuate; stainless steel	 4 047075 104284
4.328.09	reco-plate 3.5; 9 holes; breadth 10; arcuate; stainless steel	 4 047075 104291
4.328.10	reco-plate 3.5; 10 holes; breadth 10; arcuate; stainless steel	 4 047075 104307
4.328.12	reco-plate 3.5; 12 holes; breadth 10; arcuate; stainless steel	 4 047075 104222
4.328.14	reco-plate 3.5; 14 holes; breadth 10; arcuate; stainless steel	 4 047075 104499
4.328.16	reco-plate 3.5; 16 holes; breadth 10; arcuate; stainless steel	 4 047075 104390
4.328.18	reco-plate 3.5; 18 holes; breadth 10; arcuate; stainless steel	 4 047075 104406

Distal humerus plate Y 3.5 Reco – plate thickness 2.2 mm

4.861.03	Y-reco plate for distal humerus 3.5; 3 holes; breadth 10 mm; stainless steel	 4 047075 048632
4.861.06	Y-reco plate for distal humerus 3.5; 6 holes; breadth 10 mm; stainless steel	 4 047075 048717
4.861.07	Y-reco plate for distal humerus 3.5; 7 holes; breadth 10 mm; stainless steel	 4 047075 037872
4.861.08	Y-reco plate for distal humerus 3.5; 8 holes; breadth 10 mm; stainless steel	 4 047075 048793
4.861.10	Y-reco plate for distal humerus 3.5; 10 holes; breadth 10 mm; stainless steel	 4 047075 048625

Reco plate 4.5 acetabulum DC bent

standard; for screws \varnothing 4.5 mm; titanium



Item no. 5.326.06

Item no.	Item description	EAN
Reco plate 4.5 acetabulum DC bent – plate thickness 3.2 mm		
5.326.04	reco-plate for acetabulum with DC holes 4.5; 4 holes; breadth 11.5 mm; arcuate; titanium	4 047075 004324
5.326.05	reco-plate for acetabulum with DC holes 4.5; 5 holes; breadth 11.5 mm; arcuate; titanium	4 047075 004331
5.326.06	reco-plate for acetabulum with DC holes 4.5; 6 holes; breadth 11.5 mm; arcuate; titanium	4 047075 004348
5.326.08	reco-plate for acetabulum with DC holes 4.5; 8 holes; breadth 11.5 mm; arcuate; titanium	4 047075 004355
5.326.10	reco-plate for acetabulum with DC holes 4.5; 10 holes; breadth 11.5 mm; arcuate; titanium	4 047075 004140
5.326.12	reco-plate for acetabulum with DC holes 4.5; 12 holes; breadth 11.5 mm; arcuate; titanium	4 047075 004386

Reco plate 4.5 acetabulum DC

standard; for screws Ø 4.5 mm; stainless steel



Item no. 4.338.06

Item no.	Item description	EAN
Reco plate 4.5 acetabulum DC – plate thickness 3.2 mm		
4.338.03	reco-plate for acetabulum with DC holes 4.5; 3 holes; 46 x 11.5 mm; stainless steel	4 047075 104635
4.338.04	reco-plate for acetabulum with DC holes 4.5; 4 holes; 62 x 11.5 mm; stainless steel	4 047075 104642
4.338.05	reco-plate for acetabulum with DC holes 4.5; 5 holes; 78 x 11.5 mm; stainless steel	4 047075 104666
4.338.06	reco-plate for acetabulum with DC holes 4.5; 6 holes; 94 x 11.5 mm; stainless steel	4 047075 104673
4.338.07	reco-plate for acetabulum with DC holes 4.5; 7 holes; 110 x 11.5 mm; stainless steel	4 047075 104871
4.338.08	reco-plate for acetabulum with DC holes 4.5; 8 holes; 126 x 11.5 mm; stainless steel	4 047075 104888
4.338.09	reco-plate for acetabulum with DC holes 4.5; 9 holes; 142 x 11.5 mm; stainless steel	4 047075 104789
4.338.10	reco-plate for acetabulum with DC holes 4.5; 10 holes; 158 x 11.5 mm; stainless steel	4 047075 104901
4.338.11	reco-plate for acetabulum with DC holes 4.5; 11 holes; 174 x 11.5 mm; stainless steel	4 047075 104796
4.338.12	reco-plate for acetabulum with DC holes 4.5; 12 holes; 190 x 11.5 mm; stainless steel	4 047075 104802
4.338.13	reco-plate for acetabulum with DC holes 4.5; 13 holes; 206 x 11.5 mm; stainless steel	4 047075 104819
4.338.14	reco-plate for acetabulum with DC holes 4.5; 14 holes; 222 x 11.5 mm; stainless steel	4 047075 104703
4.338.15	reco-plate for acetabulum with DC holes 4.5; 15 holes; 238 x 11.5 mm; stainless steel	4 047075 104994
4.338.16	reco-plate for acetabulum with DC holes 4.5; 16 holes; 254 x 11.5 mm; stainless steel	4 047075 104918

OP set angle-stable one third tubular plates/reco plates

for screws Ø 3.5 mm; complete set item no. 19.473.00



Variable angle-stable reco plate
item no. 5.3133.06



Angle-stable one third tubular plate
item no. 5.809.06



OP-set complete
item no. 19.473.00

Item description	item no.	quantity
Implants		
<u>Variable angle-stable reco plates, titanium</u>		
for screws Ø 3.5 mm, 58 x 10 mm, 5 holes	5.3133.05	1
for screws Ø 3.5 mm, 70 x 10 mm, 6 holes	5.3133.06	1
for screws Ø 3.5 mm, 82 x 10 mm, 7 holes	5.3133.07	1
for screws Ø 3.5 mm, 94 x 10 mm, 8 holes	5.3133.08	1
<u>Angle-stable one third tubular plate</u>		
for screws Ø 3.5 mm, 61 x 9 mm, 5 holes	5.809.05	1
for screws Ø 3.5 mm, 73 x 9 mm, 6 holes	5.809.06	1
for screws Ø 3.5 mm, 85 x 9 mm, 7 holes	5.809.07	1
for screws Ø 3.5 mm, 97 x 9 mm, 8 holes	5.809.08	1

Instruments		
drill bit f. quick coupling, Ø 2.5 x 105, spiral length 50, double spiral	2.904.05	1
drill bit for quick coupling, Ø 3.5 x 110, spiral length 40, double spiral	2.904.10	1
drill guide w. handle f. var. angle-stable screwing, SF, length 45	2.977.08	1
drill guide for angle stable screwing, length 45, small fragment	2.977.01	2
drill guide with handle for small fragment, handle length 55	10.500.27A	1
double drill guide Ø 2.5/Ø 3.5, spring bushing	10.520.30	1
hex screwdriver w. handle f. screws Ø 2.7-4.0, AF 2.5, conical	2.9406.25	1
gauge w. clasp f. screws w. con. head thread Ø 3.5, Ø 4.0, MR 60	2.953.60	1
bending lever for reco plates small fragment	2.911.06	2
screw forceps, self holding	2.954.01	1

Wire		
Kirschner wire with trocar point and round end, Ø 1.6 x 150, st.st.	6.031.16	5

Container		
perforated autoclavable container with inset for instruments implants for angle-stable plates, SF	19.475.00/1	1

Item description	item no.	quantity
Cortical screws		
titanium, fully threaded, self-tapping, Ø 3.5 mm		
length 10 mm	3.132.10	2
length 12 mm	3.132.12	2
length 14 mm	3.132.14	2
length 16 mm	3.132.16	2
length 18 mm	3.132.18	2
length 20 mm	3.132.20	2
length 22 mm	3.132.22	2
length 24 mm	3.132.24	2
length 26 mm	3.132.26	2
length 28 mm	3.132.28	2
length 30 mm	3.132.30	2
length 34 mm	3.132.34	2
length 36 mm	3.132.36	2
length 38 mm	3.132.38	2



Angle-stable cortical screws		
titanium, fully threaded, self-tapping, Ø 3.5 mm		
length 10 mm	3.133.10	4
length 12 mm	3.133.12	4
length 14 mm	3.133.14	4
length 16 mm	3.133.16	4
length 18 mm	3.133.18	4
length 20 mm	3.133.20	4
length 22 mm	3.133.22	4
length 24 mm	3.133.24	4
length 26 mm	3.133.26	4



OP set angle-stable one third tubular plates/reco plates for screws Ø 3.5 mm; complete set item no. 19.473.00

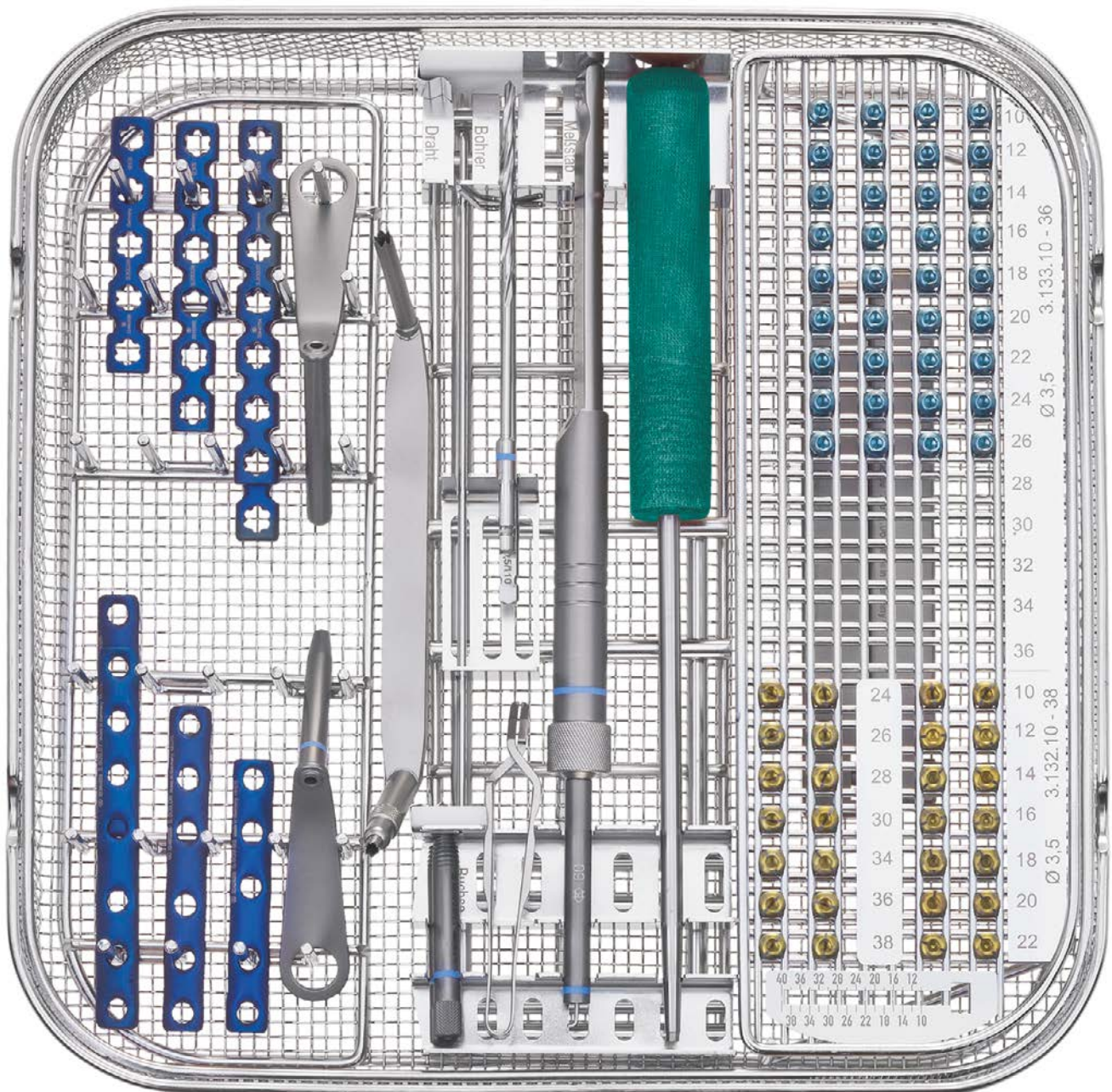

Third tubular plates 3.5

standard; for screws Ø 3.5 mm; plate thickness 1.2 mm; titanium



Item no. 5.800.06



Item no. 5.806.06



Item no. 5.808.06

Item no.	Item description	EAN
Third tubular plate 3.5		
5.800.02	one third tubular plate with round holes 3.5; 2 holes; 25 x 9 mm; titanium	4 047075 008773
5.800.03	one third tubular plate with round holes 3.5; 3 holes; 37 x 9 mm; titanium	4 047075 008582
5.800.04	one third tubular plate with round holes 3.5; 4 holes; 49 x 9 mm; titanium	4 047075 008599
5.800.05	one third tubular plate with round holes 3.5; 5 holes; 61 x 9 mm; titanium	4 047075 008735
5.800.06	one third tubular plate with round holes 3.5; 6 holes; 73 x 9 mm; titanium	4 047075 008742
5.800.07	one third tubular plate with round holes 3.5; 7 holes; 85 x 9 mm; titanium	4 047075 008810
5.800.08	one third tubular plate with round holes 3.5; 8 holes; 97 x 9 mm; titanium	4 047075 008827
5.800.09	one third tubular plate with round holes 3.5; 9 holes; 109 x 9 mm; titanium	4 047075 008834
5.800.10	one third tubular plate with round holes 3.5; 10 holes; 121 x 9 mm; titanium	4 047075 008841
5.800.11	one third tubular plate with round holes 3.5; 11 holes; 133 x 9 mm; titanium	4 047075 008612
5.800.12	one third tubular plate with round holes 3.5; 12 holes; 145 x 9 mm; titanium	4 047075 008681
5.800.14	one third tubular plate with round holes 3.5; 14 holes; 169 x 9 mm; titanium	4 047075 008872
Third tubular plate 3.5 DC		
5.806.02	one third tubular plate with DC holes 3.5; 2 holes; 25 x 9 mm; titanium	4 047075 008674
5.806.03	one third tubular plate with DC holes 3.5; 3 holes; 37 x 9 mm; titanium	4 047075 008926
5.806.04	one third tubular plate with DC holes 3.5; 4 holes; 49 x 9 mm; titanium	4 047075 008933
5.806.05	one third tubular plate with DC holes 3.5; 5 holes; 61 x 9 mm; titanium	4 047075 008780
5.806.06	one third tubular plate with DC holes 3.5; 6 holes; 73 x 9 mm; titanium	4 047075 008797
5.806.07	one third tubular plate with DC holes 3.5; 7 holes; 85 x 9 mm; titanium	4 047075 008902
5.806.08	one third tubular plate with DC holes 3.5; 8 holes; 97 x 9 mm; titanium	4 047075 008919
5.806.09	one third tubular plate with DC holes 3.5; 9 holes; 109 x 9 mm; titanium	4 047075 008988
5.806.10	one third tubular plate with DC holes 3.5; 10 holes; 121 x 9 mm; titanium	4 047075 008995
5.806.11	one third tubular plate with DC holes 3.5; 11 holes; 133 x 9 mm; titanium	4 047075 038367
5.806.12	one third tubular plate with DC holes 3.5; 12 holes; 145 x 9 mm; titanium	4 047075 009008
5.806.14	one third tubular plate with DC holes 3.5; 14 holes; 169 x 9 mm; titanium	4 047075 009015

Third tubular plates 3.5

standard; for screws Ø 3.5 mm; plate thickness 1.2 mm; titanium

Item no.	Item description	EAN
Third tubular plate 3.5 bulge		
5.808.02	one third tubular plate with collar 3.5; 2 holes; 25 x 9 mm; titanium	4 047075 008803
5.808.03	one third tubular plate with collar 3.5; 3 holes; 37 x 9 mm; titanium	4 047075 008865
5.808.04	one third tubular plate with collar 3.5; 4 holes; 49 x 9 mm; titanium	4 047075 009053
5.808.05	one third tubular plate with collar 3.5; 5 holes; 61 x 9 mm; titanium	4 047075 009060
5.808.06	one third tubular plate with collar 3.5; 6 holes; 73 x 9 mm; titanium	4 047075 009077
5.808.07	one third tubular plate with collar 3.5; 7 holes; 85 x 9 mm; titanium	4 047075 008858
5.808.08	one third tubular plate with collar 3.5; 8 holes; 97 x 9 mm; titanium	4 047075 009107
5.808.09	one third tubular plate with collar 3.5; 9 holes; 109 x 9 mm; titanium	4 047075 009114
5.808.10	one third tubular plate with collar 3.5; 10 holes; 121 x 9 mm; titanium	4 047075 008940
5.808.11	one third tubular plate with collar 3.5; 11 holes; 133 x 9 mm; titanium	4 047075 008957
5.808.12	one third tubular plate with collar 3.5; 12 holes; 145 x 9 mm; titanium	4 047075 009084
5.808.14	one third tubular plate with collar 3.5; 14 holes; 169 x 9 mm; titanium	4 047075 009091
5.808.16	one third tubular plate with collar 3.5; 16 holes; 193 x 9 mm; titanium	4 047075 009152

Third tubular plate 3.5 as

angle-stable; for screws \varnothing 3.5 mm; plate thickness 1.2 mm; titanium



Item no. 5.809.06

Item no.	Item description	EAN
5.809.03	one third tubular plate with conical thread 3.5; 3 holes; 37 x 9 mm; titanium	4 047075 111619
5.809.04	one third tubular plate with conical thread 3.5; 4 holes; 49 x 9 mm; titanium	4 047075 114665
5.809.05	one third tubular plate with conical thread 3.5; 5 holes; 61 x 9 mm; titanium	4 047075 112265
5.809.06	one third tubular plate with conical thread 3.5; 6 holes; 73 x 9 mm; titanium	4 047075 112272
5.809.07	one third tubular plate with conical thread 3.5; 7 holes; 85 x 9 mm; titanium	4 047075 112289
5.809.08	one third tubular plate with conical thread 3.5; 8 holes; 97 x 9 mm; titanium	4 047075 112487
5.809.09	one third tubular plate with conical thread 3.5; 9 holes; 109 x 9 mm; titanium	4 047075 112494
5.809.10	one third tubular plate with conical thread 3.5; 10 holes; 121 x 9 mm; titanium	4 047075 117451
5.809.12	one third tubular plate with conical thread 3.5; 12 holes; 145 x 9 mm; titanium	4 047075 120727
5.809.14	one third tubular plate with conical thread 3.5; 14 holes; 169 x 9 mm; titanium	4 047075 120871

Third tubular plates 3.5

standard; for screws Ø 3.5 mm; plate thickness 1.1 mm; stainless steel



Item no. 4.800.06



Item no. 4.806.06



Item no. 4.808.06













Item no.	Item description	EAN
Third tubular plate 3.5		
4.800.02	one third tubular plate with round holes 3.5; 2 holes; 25 x 9 mm; stainless steel	4 047075 051120
4.800.03	one third tubular plate with round holes 3.5; 3 holes; 37 x 9 mm; stainless steel	4 047075 051199
4.800.04	one third tubular plate with round holes 3.5; 4 holes; 49 x 9 mm; stainless steel	4 047075 051205
4.800.05	one third tubular plate with round holes 3.5; 5 holes; 61 x 9 mm; stainless steel	4 047075 051212
4.800.06	one third tubular plate with round holes 3.5; 6 holes; 73 x 9 mm; stainless steel	4 047075 051328
4.800.07	one third tubular plate with round holes 3.5; 7 holes; 85 x 9 mm; stainless steel	4 047075 051243
4.800.08	one third tubular plate with round holes 3.5; 8 holes; 97 x 9 mm; stainless steel	4 047075 051335
4.800.09	one third tubular plate with round holes 3.5; 9 holes; 109 x 9 mm; stainless steel	4 047075 051342
4.800.10	one third tubular plate with round holes 3.5; 10 holes; 121 x 9 mm; stainless steel	4 047075 051144
4.800.11	one third tubular plate with round holes 3.5; 11 holes; 133 x 9 mm; stainless steel	4 047075 051229
4.800.12	one third tubular plate with round holes 3.5; 12 holes; 145 x 9 mm; stainless steel	4 047075 051236
4.800.14	one third tubular plate with round holes 3.5; 14 holes; 169 x 9 mm; stainless steel	4 047075 051250
Third tubular plate 3.5 DC		
4.806.02	one third tubular plate with DC holes 3.5; 2 holes; 25 x 9 mm; stainless steel	4 047075 051182
4.806.03	one third tubular plate with DC holes 3.5; 3 holes; 37 x 9 mm; stainless steel	4 047075 051007
4.806.04	one third tubular plate with DC holes 3.5; 4 holes; 49 x 9 mm; stainless steel	4 047075 051014
4.806.05	one third tubular plate with DC holes 3.5; 5 holes; 61 x 9 mm; stainless steel	4 047075 051021
4.806.06	one third tubular plate with DC holes 3.5; 6 holes; 73 x 9 mm; stainless steel	4 047075 051106
4.806.07	one third tubular plate with DC holes 3.5; 7 holes; 85 x 9 mm; stainless steel	4 047075 051045
4.806.08	one third tubular plate with DC holes 3.5; 8 holes; 97 x 9 mm; stainless steel	4 047075 051137
4.806.09	one third tubular plate with DC holes 3.5; 9 holes; 109 x 9 mm; stainless steel	4 047075 050949
4.806.10	one third tubular plate with DC holes 3.5; 10 holes; 121 x 9 mm; stainless steel	4 047075 050956
4.806.11	one third tubular plate with DC holes 3.5; 11 holes; 133 x 9 mm; stainless steel	4 047075 051038
4.806.12	one third tubular plate with DC holes 3.5; 12 holes; 145 x 9 mm; stainless steel	4 047075 050987
4.806.13	one third tubular plate with DC holes 3.5; 13 holes; 157 x 9 mm; stainless steel	4 047075 051052

Third tubular plates 3.5

standard; for screws Ø 3.5 mm; plate thickness 1.1 mm; stainless steel

Item no.	Item description	EAN
4.806.14	one third tubular plate with DC holes 3.5; 14 holes; 169 x 9 mm; stainless steel	 4 047075 051069
4.806.16	one third tubular plate with DC holes 3.5; 16 holes; 193 x 9 mm; stainless steel	 4 047075 051076

Third tubular plate 3.5 bulge





4.808.02	one third tubular plate with collar 3.5; 2 holes; 25 x 9 mm; stainless steel	 4 047075 050826
4.808.03	one third tubular plate with collar 3.5; 3 holes; 37 x 9 mm; stainless steel	 4 047075 050833
4.808.04	one third tubular plate with collar 3.5; 4 holes; 49 x 9 mm; stainless steel	 4 047075 050840
4.808.05	one third tubular plate with collar 3.5; 5 holes; 61 x 9 mm; stainless steel	 4 047075 050918
4.808.06	one third tubular plate with collar 3.5; 6 holes; 73 x 9 mm; stainless steel	 4 047075 050864
4.808.07	one third tubular plate with collar 3.5; 7 holes; 85 x 9 mm; stainless steel	 4 047075 050925
4.808.08	one third tubular plate with collar 3.5; 8 holes; 97 x 9 mm; stainless steel	 4 047075 050932
4.808.09	one third tubular plate with collar 3.5; 9 holes; 109 x 9 mm; stainless steel	 4 047075 050765
4.808.10	one third tubular plate with collar 3.5; 10 holes; 121 x 9 mm; stainless steel	 4 047075 050857
4.808.11	one third tubular plate with collar 3.5; 11 holes; 133 x 9 mm; stainless steel	 4 047075 050796
4.808.12	one third tubular plate with collar 3.5; 12 holes; 145 x 9 mm; stainless steel	 4 047075 050871
4.808.14	one third tubular plate with collar 3.5; 14 holes; 169 x 9 mm; stainless steel	 4 047075 050888

Third tubular plate 3.5 as bulge

angle-stable; for screws \varnothing 3.5 mm; plate thickness 1.1 mm; stainless steel

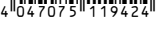

Item no. 4.8082.06

Item no.	Item description	EAN
4.8082.05	one third tubular plate with conical thread 3.5; 5 holes; 61 x 9 mm; stainless steel	 4 047075 119387
4.8082.06	one third tubular plate with conical thread 3.5; 6 holes; 73 x 9 mm; stainless steel	 4 047075 119394
4.8082.07	one third tubular plate with conical thread 3.5; 7 holes; 85 x 9 mm; stainless steel	 4 047075 119400
4.8082.08	one third tubular plate with conical thread 3.5; 8 holes; 97 x 9 mm; stainless steel	 4 047075 119417
4.8082.09	one third tubular plate with conical thread 3.5; 9 holes; 109 x 9 mm; stainless steel	 4 047075 119424

Low contact plate 3.5/4.0

for screws \varnothing 3.5 mm and \varnothing 4.0 mm; titanium



Item no. 5.220.12



Item no. 5.220.08; front



Item no. 5.220.08; back

Item no.	Item description	EAN
5.220.02	Low-contact plate 3.5 and 4.0; 2 holes; 25 mm x 11 mm; titanium	4 047075 003068
5.220.03	Low-contact plate 3.5 and 4.0; 3 holes; 38 mm x 11 mm; titanium	4 047075 003075
5.220.04	Low-contact plate 3.5 and 4.0; 4 holes; 51 mm x 11 mm; titanium	4 047075 003129
5.220.05	Low-contact plate 3.5 and 4.0; 5 holes; 64 mm x 11 mm; titanium	4 047075 003136
5.220.06	Low-contact plate 3.5 and 4.0; 6 holes; 77 mm x 11 mm; titanium	4 047075 003143
5.220.07	Low-contact plate 3.5 and 4.0; 7 holes; 90 mm x 11 mm; titanium	4 047075 003150
5.220.08	Low-contact plate 3.5 and 4.0; 8 holes; 103 mm x 11 mm; titanium	4 047075 002955
5.220.09	Low-contact plate 3.5 and 4.0; 9 holes; 116 mm x 11 mm; titanium	4 047075 003174
5.220.10	Low-contact plate 3.5 and 4.0; 10 holes; 129 mm x 11 mm; titanium	4 047075 003181
5.220.11	Low-contact plate 3.5 and 4.0; 11 holes; 142 mm x 11 mm; titanium	4 047075 003198
5.220.12	Low-contact plate 3.5 and 4.0; 12 holes; 155 mm x 11 mm; titanium	4 047075 003204
5.220.13	Low-contact plate 3.5 and 4.0; 13 holes; 168 mm x 11 mm; titanium	4 047075 003006
5.220.14	Low-contact plate 3.5 and 4.0; 14 holes; 181 mm x 11 mm; titanium	4 047075 003013
5.220.15	Low-contact plate 3.5 and 4.0; 15 holes; 194 mm x 11 mm; titanium	4 047075 003235
5.220.16	Low-contact plate 3.5 and 4.0; 16 holes; 207 mm x 11 mm; titanium	4 047075 003242
5.220.17	Low-contact plate 3.5 and 4.0; 17 holes; 220 mm x 11 mm; titanium	4 047075 003266
5.220.18	Low-contact plate 3.5 and 4.0; 18 holes; 233 mm x 11 mm; titanium	4 047075 003273
5.220.20	Low-contact plate 3.5 and 4.0; 20 holes; 259 mm x 11 mm; titanium	4 047075 003211

Low contact plate 3.5/4.0

for screws \varnothing 3.5 mm and \varnothing 4.0 mm; stainless steel

















Item no. 4.220.12



Item no. 4.220.08; front

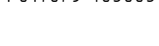

Item no. 4.220.08; back

Item no.	Item description	EAN
4.220.02	Low-contact plate 3.5 and 4.0; 2 holes; 25 x 10 mm; stainless steel	
4.220.03	Low-contact plate 3.5 and 4.0; 3 holes; 38 x 10 mm; stainless steel	
4.220.04	Low-contact plate 3.5 and 4.0; 4 holes; 51 x 10 mm; stainless steel	
4.220.05	Low-contact plate 3.5 and 4.0; 5 holes; 64 x 10 mm; stainless steel	
4.220.06	Low-contact plate 3.5 and 4.0; 6 holes; 77 x 10 mm; stainless steel	
4.220.07	Low-contact plate 3.5 and 4.0; 7 holes; 90 x 10 mm; stainless steel	
4.220.08	Low-contact plate 3.5 and 4.0; 8 holes; 103 x 10 mm; stainless steel	
4.220.09	Low-contact plate 3.5 and 4.0; 9 holes; 116 x 10 mm; stainless steel	
4.220.10	Low-contact plate 3.5 and 4.0; 10 holes; 129 x 10 mm; stainless steel	
4.220.11	Low-contact plate 3.5 and 4.0; 11 holes; 142 x 10 mm; stainless steel	
4.220.12	Low-contact plate 3.5 and 4.0; 12 holes; 155 x 10 mm; stainless steel	
4.220.13	Low-contact plate 3.5 and 4.0; 13 holes; 168 x 10 mm; stainless steel	
4.220.14	Low-contact plate 3.5 and 4.0; 14 holes; 181 x 10 mm; stainless steel	
4.220.15	Low-contact plate 3.5 and 4.0; 15 holes; 194 x 10 mm; stainless steel	
4.220.16	Low-contact plate 3.5 and 4.0; 16 holes; 207 x 10 mm; stainless steel	

Low contact plate 4.5/6.0

angle stable; for screws \varnothing 4.5 mm and \varnothing 6.0 mm; titanium



Item no. 5.231.06; front



Item no. 5.231.06; back

Item no.	Item description	EAN
Low contact plate 4.5/6.0 narrow		
5.231.02	low-contact plate with conical thread 4.5 and 6.0, 2 holes, 34x12, narrow, ti.	4 047075 112623
5.231.03	low-contact plate with conical thread 4.5 and 6.0, 3 holes, 52x12, narrow, ti.	4 047075 112630
5.231.04	low-contact plate with conical thread 4.5 and 6.0, 4 holes, 70x12, narrow, ti.	4 047075 112647
5.231.05	low-contact plate with conical thread 4.5 and 6.0, 5 holes, 88x12, narrow, ti.	4 047075 112654
5.231.06	low-contact plate with conical thread 4.5 and 6.0, 6 holes, 106x12, narrow, ti.	4 047075 112661
5.231.07	low-contact plate with conical thread 4.5 and 6.0, 7 holes, 124x12, narrow, ti.	4 047075 112678
5.231.08	low-contact plate with conical thread 4.5 and 6.0, 8 holes, 142x12, narrow, ti.	4 047075 112685
5.231.09	low-contact plate with conical thread 4.5 and 6.0, 9 holes, 160x12, narrow, ti.	4 047075 112692
5.231.10	low-contact plate with conical thread 4.5 and 6.0, 10 holes, 178x12, narrow, ti.	4 047075 112708
5.231.11	low-contact plate with conical thread 4.5 and 6.0, 11 holes, 196x12, narrow, ti.	4 047075 112715
5.231.12	low-contact plate with conical thread 4.5 and 6.0, 12 holes, 214x12, narrow, ti.	4 047075 112722
5.231.13	low-contact plate with conical thread 4.5 and 6.0, 13 holes, 232x12, narrow, ti.	4 047075 112739
5.231.14	low-contact plate with conical thread 4.5 and 6.0, 14 holes, 250x12, narrow, ti.	4 047075 112746
5.231.15	low-contact plate with conical thread 4.5 and 6.0, 15 holes, 268x12, narrow, ti.	4 047075 112753
5.231.16	low-contact plate with conical thread 4.5 and 6.0, 16 holes, 286x12, narrow, ti.	4 047075 112760

Low contact plate 4.5/6.0

angle stable; for screws \varnothing 4.5 mm and \varnothing 6.0 mm; titanium



Item no. 5.241.08

Item no.	Item description	EAN
Low contact plate 4.5/6.0 broad		
5.241.06	low-contact plate with conical thread 4.5 and 6.0, 6 holes, 106x16, broad, ti	4 047075 112906
5.241.07	low-contact plate with conical thread 4.5 and 6.0, 7 holes, 124x16, broad, ti	4 047075 112913
5.241.08	low-contact plate with conical thread 4.5 and 6.0, 8 holes, 142x16, broad, ti	4 047075 112920
5.241.09	low-contact plate with conical thread 4.5 and 6.0, 9 holes, 160x16, broad, ti	4 047075 112937
5.241.10	low-contact plate with conical thread 4.5 and 6.0, 10 holes, 178x16, broad, ti	4 047075 112944
5.241.11	low-contact plate with conical thread 4.5 and 6.0, 11 holes, 196x16, broad, ti	4 047075 112951
5.241.12	low-contact plate with conical thread 4.5 and 6.0, 12 holes, 214x16, broad, ti	4 047075 112968
5.241.13	low-contact plate with conical thread 4.5 and 6.0, 13 holes, 232x16, broad, ti	4 047075 112975
5.241.14	low-contact plate with conical thread 4.5 and 6.0, 14 holes, 250x16, broad, ti	4 047075 112982
5.241.15	low-contact plate with conical thread 4.5 and 6.0, 15 holes, 268x16, broad, ti	4 047075 112999
5.241.16	low-contact plate with conical thread 4.5 and 6.0, 16 holes, 286x16, broad, ti	4 047075 113002
5.241.17	low-contact plate with conical thread 4.5 and 6.0, 17 holes, 304x16, broad, ti	4 047075 113019
5.241.18	low-contact plate with conical thread 4.5 and 6.0, 18 holes, 322x16, broad, ti	4 047075 113026
5.241.20	low-contact plate with conical thread 4.5 and 6.0, 20 holes, 358x16, broad, ti	4 047075 127412

OP set angle-stable straight low-contact plates

for screws \varnothing 4.5/6.0 mm, titanium, complete set item no. 19.514.00



pict.: 5.231.06



pict.: 5.241.08

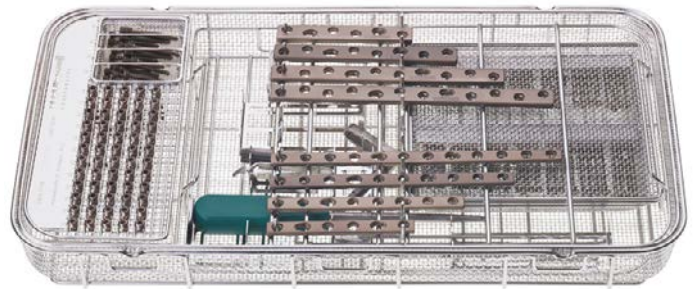



OP set complete titanium
item no. 19.514.00

item description	item no.	quantity
Implants		
<u>Angle-stable straight low contact plates, narrow with combination holes and 2 compression holes</u>		
6 holes, 106 x 12 mm	5.231.06	1
8 holes, 142 x 12 mm	5.231.08	1
10 holes, 178 x 12 mm	5.231.10	1
12 holes, 214 x 12 mm	5.231.12	1
<u>Angle-stable straight low contact plates, broad with combination holes and 2 compression holes</u>		
6 holes, 106 x 16 mm	5.241.06	1
8 holes, 142 x 16 mm	5.241.08	1
10 holes, 178 x 16 mm	5.241.10	1
12 holes, 214 x 16 mm	5.241.12	1
Further dimensions available on request.		

Instruments		
drill bit for quick coupling, \varnothing 3.2 x 195, spiral length 60, double spiral	2.904.09	1
drill guide for angle stable screwing, length 70, large fragment	2.977.02	2
drill guide for angle stable compression hole, large fragment	2.977.145	1
hex screwdriver with handle for screws \varnothing 4.5 - \varnothing 7.0, AF 3.5, length 215	2.9406.35	1
gauge with clasp for screws with conical head thread \varnothing 4.5/ \varnothing 6.0 measuring range 90	2.953.90	1
screw forceps, self holding	2.954.01	1

Container		
perforated autoclavable container with inset for instruments and straight plates; large fragment	19.513.00	1

item description	item no.	quantity
Angle-stable cortical screws		
titanium, fully threaded, conical head thread, self-tapping, \varnothing 4.5 mm		
		
length 12 mm	3.545.12	5
length 14 mm	3.545.14	5
length 16 mm	3.545.16	5
length 18 mm	3.545.18	5
length 20 mm	3.545.20	5
length 22 mm	3.545.22	5
length 24 mm	3.545.24	5
length 26 mm	3.545.26	5
length 28 mm	3.545.28	5
length 30 mm	3.545.30	5
length 32 mm	3.545.32	5
length 34 mm	3.545.34	5
length 36 mm	3.545.36	5
length 38 mm	3.545.38	5
length 40 mm	3.545.40	5
length 45 mm	3.545.45	5

cortical screws		
titanium, fully threaded, self-tapping, \varnothing 4.5 mm		
		
length 12 mm	3.152.12	4
length 16 mm	3.152.16	4
length 20 mm	3.152.20	4
length 22 mm	3.152.22	4
length 24 mm	3.152.24	4
length 26 mm	3.152.26	4
length 28 mm	3.152.28	4
length 30 mm	3.152.30	4
length 32 mm	3.152.32	4
length 34 mm	3.152.34	4
length 36 mm	3.152.36	4
length 38 mm	3.152.38	4
length 40 mm	3.152.40	4
length 42 mm	3.152.42	4

OP set angle-stable straight low-contact plates

for screws \varnothing 4.5/6.0 mm, titanium, complete set item no. 19.514.00

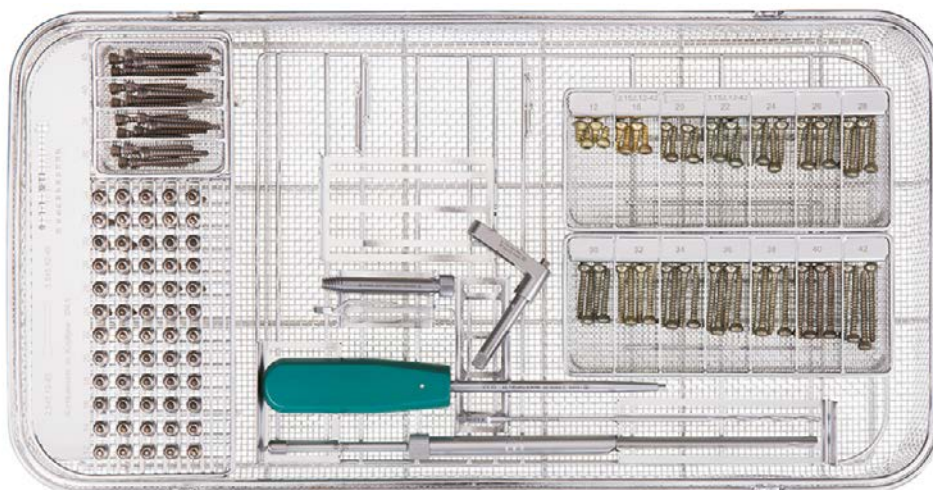
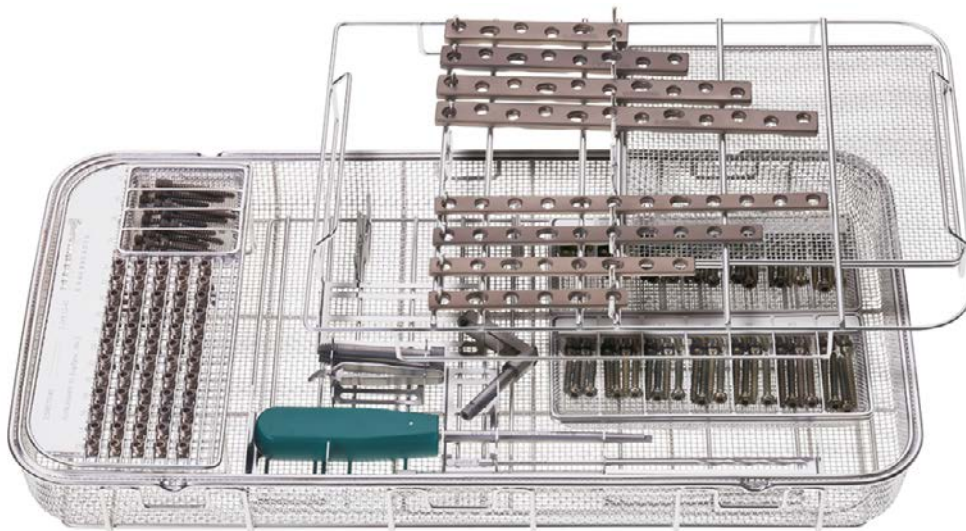

Low contact plate 4.5/6.0

angle stable; for screws \varnothing 4.5 mm and \varnothing 6.0 mm; stainless steel



Item no. 4.231.06



Item no. 4.241.12

Item no.	Item description	EAN
Low contact plate 4.5/6.0 narrow		
4.231.06	low-contact plate with conical thread 4.5 and 6.0, 6 holes, 106x12, narrow, st.st.	4 047075 118137
4.231.08	low-contact plate with conical thread 4.5 and 6.0, 8 holes, 142x12, narrow, st.st.	4 047075 118144
4.231.10	low-contact plate with conical thread 4.5 and 6.0, 10 holes, 178x12, narrow, st.st.	4 047075 118151
4.231.12	low-contact plate with conical thread 4.5 and 6.0, 12 holes, 214x12, narrow, st.st.	4 047075 118168
4.231.14	low-contact plate with conical thread 4.5 and 6.0, 14 holes, 250x12, narrow, st.st.	4 047075 124565
4.231.16	low-contact plate with conical thread 4.5 and 6.0, 16 holes, 286x12, narrow, st.st.	4 047075 133918
Low contact plate 4.5/6.0 broad		
4.241.06	low-contact plate with conical thread 4.5 and 6.0, 6 holes, 106x16, broad, st.st.	4 047075 112777
4.241.07	low-contact plate with conical thread 4.5 and 6.0, 7 holes, 124x16, broad, st.st.	4 047075 112784
4.241.08	low-contact plate with conical thread 4.5 and 6.0, 8 holes, 142x16, broad, st.st.	4 047075 112791
4.241.09	low-contact plate with conical thread 4.5 and 6.0, 9 holes, 160x16, broad, st.st.	4 047075 112807
4.241.10	low-contact plate with conical thread 4.5 and 6.0, 10 holes, 178x16, broad, st.st.	4 047075 112814
4.241.11	low-contact plate with conical thread 4.5 and 6.0, 11 holes, 196x16, broad, st.st.	4 047075 112821
4.241.12	low-contact plate with conical thread 4.5 and 6.0, 12 holes, 214x16, broad, st.st.	4 047075 112838
4.241.13	low-contact plate with conical thread 4.5 and 6.0, 13 holes, 232x16, broad, st.st.	4 047075 112845
4.241.14	low-contact plate with conical thread 4.5 and 6.0, 14 holes, 250x16, broad, st.st.	4 047075 112852
4.241.15	low-contact plate with conical thread 4.5 and 6.0, 15 holes, 268x16, broad, st.st.	4 047075 112869
4.241.16	low-contact plate with conical thread 4.5 and 6.0, 16 holes, 286x16, broad, st.st.	4 047075 112876
4.241.17	low-contact plate with conical thread 4.5 and 6.0, 17 holes, 304x16, broad, st.st.	4 047075 112883
4.241.18	low-contact plate with conical thread 4.5 and 6.0, 18 holes, 322x16, broad, st.st.	4 047075 112890
4.241.20	low-contact plate with conical thread 4.5 and 6.0, 20 holes, 358x16, broad, st.st.	4 047075 133925

OP set angle-stable straight low-contact plates

for screws Ø 4.5/6.0 mm, stainless steel, complete set item no. 19.512.00



Art.-Nr.
4.231.12



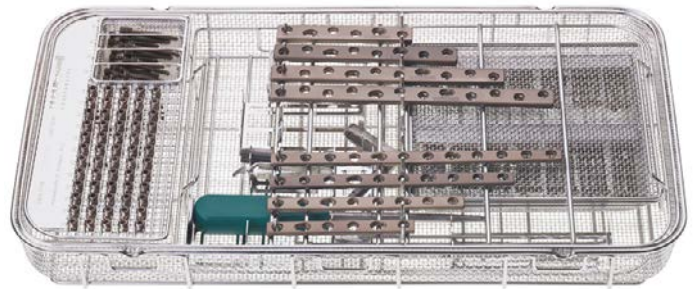

Art.-Nr.
4.241.12



OP set complete stainless steel, item no. 19.512.00
(image above shows the set in titanium)

item description	item no.	quantity
Implants		
<u>Angle-stable straight low contact plates, narrow with combination holes and 2 compression holes</u>		
6 holes, 106 x 12 mm	4.231.06	1
8 holes, 142 x 12 mm	4.231.08	1
10 holes, 178 x 12 mm	4.231.10	1
12 holes, 214 x 12 mm	4.231.12	1
<u>Angle-stable straight low contact plates, broad with combination holes and 2 compression holes</u>		
6 holes, 106 x 16 mm	4.241.06	1
8 holes, 142 x 16 mm	4.241.08	1
10 holes, 178 x 16 mm	4.241.10	1
12 holes, 214 x 16 mm	4.241.12	1
Further dimensions available on request.		
Instruments		
drill bit for quick coupling, Ø 3.2 x 195, spiral length 60, double spiral	2.904.09	1
drill guide for angle stable screwing, length 70, large fragment	2.977.02	2
drill guide for angle stable compression hole, large fragment	2.977.1.45	1
hex screwdriver with handle for screws Ø 4.5 - Ø 7.0, AF 3.5, length 215	2.9406.35	1
gauge with clasp for screws with conical head thread Ø 4.5/Ø 6.0 measuring range 90	2.953.90	1
screw forceps, self holding	2.954.01	1
Container		
perforated autoclavable container with inset for instruments and straight plates; large fragment	19.513.00	1

item description	item no.	quantity
Angle-stable cortical screws		
stainless steel, fully threaded, conical head thread, self-tapping, Ø 4.5 mm		
		
length 12 mm	2.545.12	5
length 14 mm	2.545.14	5
length 16 mm	2.545.16	5
length 18 mm	2.545.18	5
length 20 mm	2.545.20	5
length 22 mm	2.545.22	5
length 24 mm	2.545.24	5
length 26 mm	2.545.26	5
length 28 mm	2.545.28	5
length 30 mm	2.545.30	5
length 32 mm	2.545.32	5
length 34 mm	2.545.34	5
length 36 mm	2.545.36	5
length 38 mm	2.545.38	5
length 40 mm	2.545.40	5
length 45 mm	2.545.45	5

cortical screws		
stainless steel, fully threaded, self-tapping, Ø 4.5 mm		
		
length 12 mm	2.152.12	4
length 16 mm	2.152.16	4
length 20 mm	2.152.20	4
length 22 mm	2.152.22	4
length 24 mm	2.152.24	4
length 26 mm	2.152.26	4
length 28 mm	2.152.28	4
length 30 mm	2.152.30	4
length 32 mm	2.152.32	4
length 34 mm	2.152.34	4
length 36 mm	2.152.36	4
length 38 mm	2.152.38	4
length 40 mm	2.152.40	4
length 42 mm	2.152.42	4

OP set angle-stable straight low-contact plates

for screws \varnothing 4.5/6.0 mm, stainless steel, complete set item no. 19.512.00

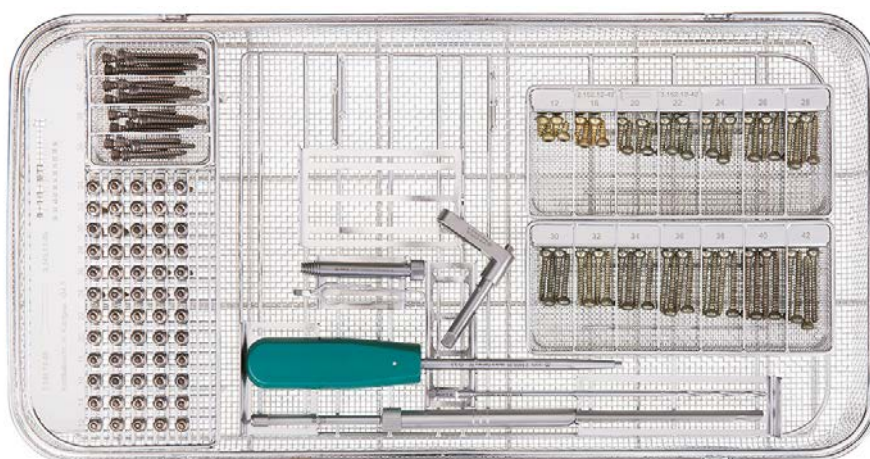
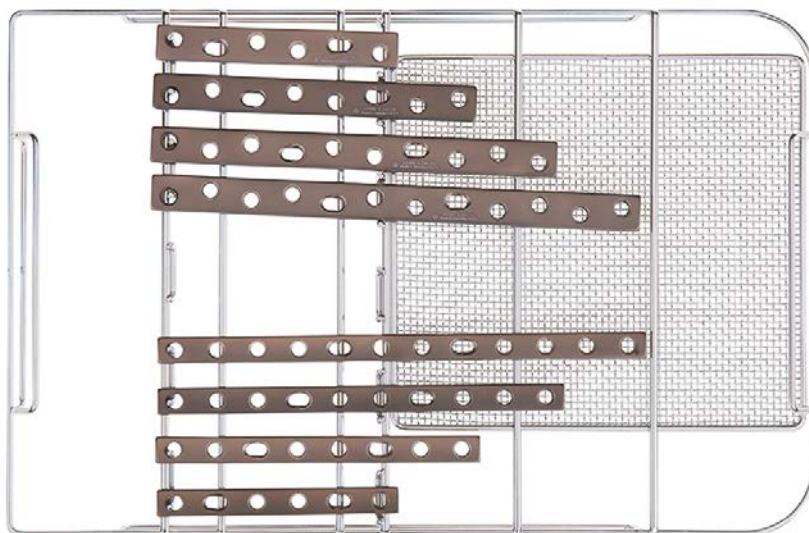
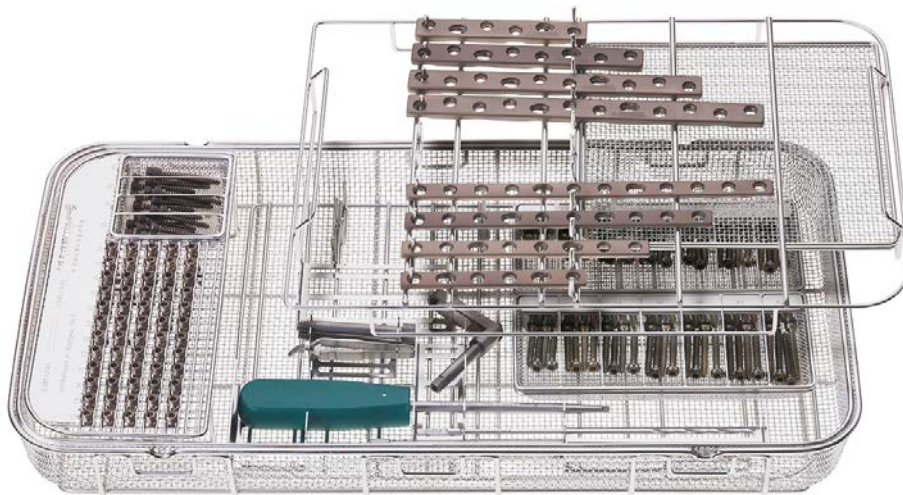

Attention: The images above show the set in titanium.

L and T plates Mini

Standard; for screws Ø 2.0 and Ø 2.7 mm; titanium



Item no. 5.910.05



Item no. 5.920.05



Item no. 5.830.04

































Item no. 5.840.04

Item no.	Item description	EAN
L plate Mini 2.0 – plate thickness 1.0 mm		
5.910.02	mini L-plate 2.0; 2 holes; 19 x 5 mm; straight; right; titanium	4 047075 011414
5.910.03	mini L-plate 2.0; 3 holes; 25 x 5 mm; straight; right; titanium	4 047075 011186
5.910.04	mini L-plate 2.0; 4 holes; 31 x 5 mm; straight; right; titanium	4 047075 011438
5.910.05	mini L-plate 2.0; 5 holes; 37 x 5 mm; straight; right; titanium	4 047075 011445
5.910.06	mini L-plate 2.0; 6 holes; 43 x 5 mm; straight; right; titanium	4 047075 011285
5.910.07	mini L-plate 2.0; 7 holes; 49 x 5 mm; straight; right; titanium	4 047075 011469
5.910.08	mini L-plate 2.0; 8 holes; 55 x 5 mm; straight; right; titanium	4 047075 011421
5.911.02	mini L-plate 2.0; 2 holes; 19 x 5 mm; straight; left; titanium	4 047075 011490
5.911.03	mini L-plate 2.0; 3 holes; 25 x 5 mm; straight; left; titanium	4 047075 011506
5.911.04	mini L-plate 2.0; 4 holes; 31 x 5 mm; straight; left; titanium	4 047075 011513
5.911.05	mini L-plate 2.0; 5 holes; 37 x 5 mm; straight; left; titanium	4 047075 011520
5.911.06	mini L-plate 2.0; 6 holes; 43 x 5 mm; straight; left; titanium	4 047075 011292
5.911.07	mini L-plate 2.0; 7 holes; 49 x 5 mm; straight; left; titanium	4 047075 011308
5.911.08	Mini-L plate 2.0; 8 Loch; 55 x 5 mm; gerade; links; Titan	4 047075 011544
L plate Mini 2.0 skew – plate thickness 1.0 mm		
5.920.02	mini L-plate 2.0; 2 holes; 20 x 5 mm; oblique; right; titanium	4 047075 011551
5.920.03	mini L-plate 2.0; 3 holes; 26 x 5 mm; oblique; right; titanium	4 047075 011568
5.920.04	mini L-plate 2.0; 4 holes; 32 x 5 mm; oblique; right; titanium	4 047075 011575
5.920.05	mini L-plate 2.0; 5 holes; 38 x 5 mm; oblique; right; titanium	4 047075 011377
5.920.06	mini L-plate 2.0; 6 holes; 44 x 5 mm; oblique; right; titanium	4 047075 011599
5.920.07	mini L-plate 2.0; 7 holes; 50 x 5 mm; oblique; right; titanium	4 047075 011605
5.920.08	mini L-plate 2.0; 8 holes; 56 x 5 mm; oblique; right; titanium	4 047075 011452
5.921.02	mini L-plate 2.0; 2 holes; 20 x 5 mm; oblique; left; titanium	4 047075 011629
5.921.03	mini L-plate 2.0; 3 holes; 26 x 5 mm; oblique; left; titanium	4 047075 011582
5.921.04	mini L-plate 2.0; 4 holes; 32 x 5 mm; oblique; left; titanium	4 047075 011650

L and T plates Mini

Standard; for screws Ø 2.0 and Ø 2.7 mm; titanium

Item no.	Item description	EAN
5.921.05	mini L-plate 2.0; 5 holes; 38 x 5 mm; oblique; left; titanium	 4 047075 011667
5.921.06	mini L-plate 2.0; 6 holes; 44 x 5 mm; oblique; left; titanium	 4 047075 011674
5.921.07	mini L-plate 2.0; 7 holes; 50 x 5 mm; oblique; left; titanium	 4 047075 011681
5.921.08	mini L-plate 2.0; 8 holes; 56 x 5 mm; oblique; left; titanium	 4 047075 011476
L plate Mini 2.7 – plate thickness 1.0 mm		
5.830.03	mini L-plate 2.7; 3 holes; 32 x 7 mm; straight; right; titanium	 4 047075 010097
5.830.04	mini L-plate 2.7; 4 holes; 40 x 7 mm; straight; right; titanium	 4 047075 010103
5.830.05	mini L-plate 2.7; 5 holes; 48 x 7 mm; straight; right; titanium	 4 047075 009886
5.830.06	mini L-plate 2.7; 6 holes; 56 x 7 mm; straight; right; titanium	 4 047075 009893
5.830.07	mini L-plate 2.7; 7 holes; 64 x 7 mm; straight; right; titanium	 4 047075 010127
5.830.08	mini L-plate 2.7; 8 holes; 72 x 7 mm; straight; right; titanium	 4 047075 010134
5.831.02	mini L-plate 2.7; 2 holes; 24 x 7 mm; straight; left; titanium	 4 047075 010141
5.831.03	mini L-plate 2.7; 3 holes; 32 x 7 mm; straight; left; titanium	 4 047075 010158
5.831.04	mini L-plate 2.7; 4 holes; 40 x 7 mm; straight; left; titanium	 4 047075 009947
5.831.05	mini L-plate 2.7; 5 holes; 48 x 7 mm; straight; left; titanium	 4 047075 010172
5.831.06	mini L-plate 2.7; 6 holes; 56 x 7 mm; straight; left; titanium	 4 047075 010189
5.831.07	mini L-plate 2.7; 7 holes; 64 x 7 mm; straight; left; titanium	 4 047075 010042
5.831.08	mini L-plate 2.7; 8 holes; 72 x 7 mm; straight; left; titanium	 4 047075 010202
L plate Mini 2.7 skew – plate thickness 1.0 mm		
5.840.02	mini L-plate 2.7; 2 holes; 27 x 7 mm; oblique; right; titanium	 4 047075 010233
5.840.03	mini L-plate 2.7; 3 holes; 35 x 7 mm; oblique; right; titanium	 4 047075 010240
5.840.04	mini L-plate 2.7; 4 holes; 43 x 7 mm; oblique; right; titanium	 4 047075 010257
5.840.05	mini L-plate 2.7; 5 holes; 51 x 7 mm; oblique; right; titanium	 4 047075 010264
5.840.06	mini L-plate 2.7; 6 holes; 59 x 7 mm; oblique; right; titanium	 4 047075 010059
5.840.07	mini L-plate 2.7; 7 holes; 67 x 7 mm; oblique; right; titanium	 4 047075 010066
5.840.08	mini L-plate 2.7; 8 holes; 75 x 7 mm; oblique; right; titanium	 4 047075 010288
5.841.02	mini L-plate 2.7; 2 holes; 27 x 7 mm; oblique; left; titanium	 4 047075 129942
5.841.03	mini L-plate 2.7; 3 holes; 35 x 7 mm; oblique; left; titanium	 4 047075 010295
5.841.04	mini L-plate 2.7; 4 holes; 43 x 7 mm; oblique; left; titanium	 4 047075 010301
5.841.05	mini L-plate 2.7; 5 holes; 51 x 7 mm; oblique; left; titanium	 4 047075 010318
5.841.06	mini L-plate 2.7; 6 holes; 59 x 7 mm; oblique; left; titanium	 4 047075 010110
5.841.07	mini L-plate 2.7; 7 holes; 67 x 7 mm; oblique; left; titanium	 4 047075 010332
5.841.08	mini L-plate 2.7; 8 holes; 75 x 7 mm; oblique; left; titanium	 4 047075 010349

L and T plates Mini

Standard; for screws Ø 2.0 and Ø 2.7 mm; titanium



Item no. 5.416.49



Item no. 5.850.05



Item no. 5.930.05

Item no.	Item description	EAN
T plate Mini 2.0 – plate thickness 1.5 mm		
5.416.39	mini T-plate 2.0/2.0; 3/9 holes; 50 x 5 mm; titanium	4 047075 005024
5.416.49	mini T-plate 2.0/2.0; 4/9 holes; 50 x 5 mm; titanium	4 047075 005031
T plate Mini 2.0/2.7 – plate thickness 1.0 mm		
5.850.02	mini T-plate with round holes 2.0 and 2.7; 2 holes; 24 x 7 mm; titanium	4 047075 010196
5.850.03	mini T-plate with round holes 2.0 and 2.7; 3 holes; 32 x 7 mm; titanium	4 047075 010370
5.850.04	mini T-plate with round holes 2.0 and 2.7; 4 holes; 40 x 7 mm; titanium	4 047075 010325
5.850.05	mini T-plate with round holes 2.0 and 2.7; 5 holes; 48 x 7 mm; titanium	4 047075 010394
5.850.06	mini T-plate with round holes 2.0 and 2.7; 6 holes; 56 x 7 mm; titanium	4 047075 010400
5.850.07	mini T-plate with round holes 2.0 and 2.7; 7 holes; 64 x 7 mm; titanium	4 047075 010417
5.850.08	mini T-plate with round holes 2.0 and 2.7; 8 holes; 72 x 7 mm; titanium	4 047075 010424
T plate Mini 2.0 long hole – plate thickness 1.0 mm		
5.930.02	mini T-plate 2.0; 2 holes; 22 x 5.5 mm; long hole in shank; titanium	4 047075 011483
5.930.03	mini T-plate 2.0; 3 holes; 29 x 5.5 mm; long hole in shank; titanium	4 047075 011711
5.930.04	mini T-plate 2.0; 4 holes; 36 x 5.5 mm; long hole in shank; titanium	4 047075 011728
5.930.05	mini T-plate 2.0; 5 holes; 43 x 5.5 mm; long hole in shank; titanium	4 047075 011735
5.930.06	mini T-plate 2.0; 6 holes; 50 x 5.5 mm; long hole in shank; titanium	4 047075 011742
5.930.07	mini T-plate 2.0; 7 holes; 57 x 5.5 mm; long hole in shank; titanium	4 047075 011537
5.930.08	mini T-plate 2.0; 8 holes; 64 x 5.5 mm; long hole in shank; titanium	4 047075 011766

L and T plates Mini

Standard; for screws Ø 2.0 and Ø 2.7 mm; stainless steel



Item no. 4.910.02



Item no. 4.920.03



Item no. .4.830.04































Item no. 4.840.04

Item no.	Item description	EAN
L plate Mini 2.0 – plate thickness 1.0 mm		
4.910.02	mini L-plate 2.0; 2 holes; 19 x 5 mm; straight; right; stainless steel	4 047075 047970
4.910.03	mini L-plate 2.0; 3 holes; 25 x 5 mm; straight; right; stainless steel	4 047075 047987
4.910.04	mini L-plate 2.0; 4 holes; 31 x 5 mm; straight; right; stainless steel	4 047075 048069
4.910.05	mini L-plate 2.0; 5 holes; 37 x 5 mm; straight; right; stainless steel	4 047075 048014
4.910.06	mini L-plate 2.0; 6 holes; 43 x 5 mm; straight; right; stainless steel	4 047075 048076
4.910.07	mini L-plate 2.0; 7 holes; 49 x 5 mm; straight; right; stainless steel	4 047075 048083
4.910.08	mini L-plate 2.0; 8 holes; 55 x 5 mm; straight; right; stainless steel	4 047075 047949
4.911.02	mini L-plate 2.0; 2 holes; 19 x 5 mm; straight; left; stainless steel	4 047075 047994
4.911.03	mini L-plate 2.0; 3 holes; 19 x 5 mm; straight; left; stainless steel	4 047075 048007
4.911.04	mini L-plate 2.0; 4 holes; 19 x 5 mm; straight; left; stainless steel	4 047075 048021
4.911.05	mini L-plate 2.0; 5 holes; 19 x 5 mm; straight; left; stainless steel	4 047075 048038
4.911.06	mini L-plate 2.0; 6 holes; 19 x 5 mm; straight; left; stainless steel	4 047075 048045
4.911.07	mini L-plate 2.0; 7 holes; 19 x 5 mm; straight; left; stainless steel	4 047075 047895
4.911.08	mini L-plate 2.0; 8 holes; 19 x 5 mm; straight; left; stainless steel	4 047075 048106
L plate Mini 2.0 skew – plate thickness 1.0 mm		
4.920.02	mini L-plate 2.0; 2 holes; 20 x 5 mm; oblique; right; stainless steel	4 047075 047741
4.920.03	mini L-plate 2.0; 3 holes; 26 x 5 mm; oblique; right; stainless steel	4 047075 047802
4.920.04	mini L-plate 2.0; 4 holes; 32 x 5 mm; oblique; right; stainless steel	4 047075 047819
4.920.05	mini L-plate 2.0; 5 holes; 38 x 5 mm; oblique; right; stainless steel	4 047075 047826
4.920.06	mini L-plate 2.0; 6 holes; 44 x 5 mm; oblique; right; stainless steel	4 047075 047901
4.920.07	mini L-plate 2.0; 7 holes; 50 x 5 mm; oblique; right; stainless steel	4 047075 047857
4.920.08	mini L-plate 2.0; 8 holes; 56 x 5 mm; oblique; right; stainless steel	4 047075 047925
4.921.02	mini L-plate 2.0; 2 holes; 20 x 5 mm; oblique; left; stainless steel	4 047075 047932
4.921.03	mini L-plate 2.0; 3 holes; 26 x 5 mm; oblique; left; stainless steel	4 047075 047772
4.921.04	mini L-plate 2.0; 4 holes; 32 x 5 mm; oblique; left; stainless steel	4 047075 047833

L and T plates Mini

Standard; for screws Ø 2.0 and Ø 2.7 mm; stainless steel

Item no.	Item description	EAN
4.921.05	mini L-plate 2.0; 5 holes; 38 x 5 mm; oblique; left; stainless steel	
4.921.06	mini L-plate 2.0; 6 holes; 44 x 5 mm; oblique; left; stainless steel	
4.921.07	mini L-plate 2.0; 7 holes; 50 x 5 mm; oblique; left; stainless steel	
4.921.08	mini L-plate 2.0; 8 holes; 56 x 5 mm; oblique; left; stainless steel	
L plate Mini 2.7 – plate thickness 1.0 mm		
4.830.03	mini L-plate 2.7; 3 holes; 32 x 7 mm; straight; right; stainless steel	
4.830.04	mini L-plate 2.7; 4 holes; 40 x 7 mm; straight; right; stainless steel	
4.830.05	mini L-plate 2.7; 5 holes; 48 x 7 mm; straight; right; stainless steel	
4.830.06	mini L-plate 2.7; 6 holes; 56 x 7 mm; straight; right; stainless steel	
4.830.07	mini L-plate 2.7; 7 holes; 64 x 7 mm; straight; right; stainless steel	
4.830.08	mini L-plate 2.7; 8 holes; 72 x 7 mm; straight; right; stainless steel	
4.831.03	mini L-plate 2.7; 3 holes; 32 x 7 mm; straight; left; stainless steel	
4.831.04	mini L-plate 2.7; 4 holes; 40 x 7 mm; straight; left; stainless steel	
4.831.05	mini L-plate 2.7; 5 holes; 48 x 7 mm; straight; left; stainless steel	
4.831.06	mini L-plate 2.7; 6 holes; 56 x 7 mm; straight; left; stainless steel	
4.831.07	mini L-plate 2.7; 7 holes; 64 x 7 mm; straight; left; stainless steel	
4.831.08	mini L-plate 2.7; 8 holes; 72 x 7 mm; straight; left; stainless steel	
L plate Mini 2.7 skew – plate thickness 1.0 mm		
4.840.03	mini L-plate 2.7; 3 holes; 35 x 7 mm; oblique; right; stainless steel	
4.840.04	mini L-plate 2.7; 4 holes; 43 x 7 mm; oblique; right; stainless steel	
4.840.05	mini L-plate 2.7; 5 holes; 51 x 7 mm; oblique; right; stainless steel	
4.840.06	mini L-plate 2.7; 6 holes; 59 x 7 mm; oblique; right; stainless steel	
4.840.07	mini L-plate 2.7; 7 holes; 67 x 7 mm; oblique; right; stainless steel	
4.840.08	mini L-plate 2.7; 8 holes; 75 x 7 mm; oblique; right; stainless steel	
4.841.03	mini L-plate 2.7; 3 holes; 35 x 7 mm; oblique; left; stainless steel	
4.841.04	mini L-plate 2.7; 4 holes; 43 x 7 mm; oblique; left; stainless steel	
4.841.05	mini L-plate 2.7; 5 holes; 51 x 7 mm; oblique; left; stainless steel	
4.841.06	mini L-plate 2.7; 6 holes; 59 x 7 mm; oblique; left; stainless steel	
4.841.07	mini L-plate 2.7; 7 holes; 67 x 7 mm; oblique; left; stainless steel	
4.841.08	mini L-plate 2.7; 8 holes; 75 x 7 mm; oblique; left; stainless steel	

L and T plates Mini

Standard; for screws Ø 2.0 and Ø 2.7 mm; stainless steel



Item no. 4.416.37



Item no. 4.850.05

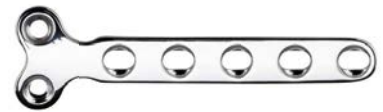

Item no. 4.930.05

Item no.	Item description	EAN
T plate Mini 2.0 – plate thickness 1.5 mm		
4.416.37	mini T-plate 2.0/2.0; 3/7 holes; 40 x 5 mm; stainless steel	4 047075 106264
4.416.39	mini T-plate 2.0/2.0; 3/9 holes; 50 x 5 mm; veterinary; stainless steel	4 047075 106417
4.416.49	mini T-plate 2.0/2.0; 4/9 holes; 50 x 5 mm; stainless steel	4 047075 106288
T plate Mini 2.0/2.7 – plate thickness 1.0 mm		
4.850.02	mini T-plate with round holes 2.0 and 2.7; 2 holes; 24 x 7 mm; stainless steel	4 047075 048663
4.850.03	mini T-plate with round holes 2.0 and 2.7; 3 holes; 32 x 7 mm; stainless steel	4 047075 048670
4.850.04	mini T-plate with round holes 2.0 and 2.7; 4 holes; 40 x 7 mm; stainless steel	4 047075 048724
4.850.05	mini T-plate with round holes 2.0 and 2.7; 5 holes; 48 x 7 mm; stainless steel	4 047075 048731
4.850.06	mini T-plate with round holes 2.0 and 2.7; 6 holes; 56 x 7 mm; stainless steel	4 047075 048755
4.850.07	mini T-plate with round holes 2.0 and 2.7; 7 holes; 64 x 7 mm; stainless steel	4 047075 048762
4.850.08	mini T-plate with round holes 2.0 and 2.7; 8 holes; 72 x 7 mm; stainless steel	4 047075 048595
T plate Mini 2.0 long hole – plate thickness 1.0 mm		
4.930.02	mini T-plate 2.0; 2 holes; 22 x 5.5 mm; long hole in shank; stainless steel	4 047075 047727
4.930.03	mini T-plate 2.0; 3 holes; 29 x 5.5 mm; long hole in shank; stainless steel	4 047075 047956
4.930.04	mini T-plate 2.0; 4 holes; 36 x 5.5 mm; long hole in shank; stainless steel	4 047075 002153
4.930.05	mini T-plate 2.0; 5 holes; 43 x 5.5 mm; long hole in shank; stainless steel	4 047075 002160
4.930.06	mini T-plate 2.0; 6 holes; 50 x 5.5 mm; long hole in shank; stainless steel	4 047075 002177
4.930.07	mini T-plate 2.0; 7 holes; 57 x 5.5 mm; long hole in shank; stainless steel	4 047075 002184
4.930.08	mini T-plate 2.0; 8 holes; 64 x 5.5 mm; long hole in shank; stainless steel	4 047075 047734
4.930.09	mini T-plate 2.0; 9 holes; 71 x 5.5 mm; long hole in shank; stainless steel	4 047075 002207

T plates Mini as

angle-stable; for screws Ø 2.0 mm; titanium



Item no. 5.9342.34











Item no. 5.9312.26

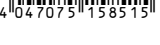

Item no. 5.9332.36

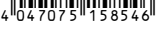

Item no. 5.9322.34

Item no.	Item description	EAN
T plate Mini 2.0 as – plate thickness 1.2 mm		
5.9342.34	mini T-plate with conical thread 2.0/2.0; 2/5 holes; 33 x 5 mm; titanium	
T plate Mini 2.0 as narrow – plate thickness 1.2 mm		
5.9312.24	mini T-plate with conical thread 2.0/2.0; 2/4 holes; 30 x 5 mm; titanium	
5.9312.26	mini T-plate with conical thread 2.0/2.0; 2/6 holes; 42 x 5 mm; titanium	
5.9312.28	mini T-plate with conical thread 2.0/2.0; 2/8 holes; 54 x 5 mm; titanium	
T plate Mini 2.0 as broad – plate thickness 1.2 mm		
5.9332.34	mini T-plate with conical thread 2.0/2.0; 3/4 holes; 30 x 5 mm; straight; titanium	
5.9332.36	mini T-plate with conical thread 2.0/2.0; 3/6 holes; 42 x 5 mm; straight; titanium	
5.9332.38	mini T-plate with conical thread 2.0/2.0; 3/8 holes; 54 x 5 mm; straight; titanium	
Y-plate Mini 2.0 as – plate thickness 1.2 mm		
5.9322.34	mini T-plate with conical thread 2.0/2.0; 3/4 holes; 33 x 5 mm; y-form; titanium	
5.9322.36	mini T-plate with conical thread 2.0/2.0; 3/6 holes; 45 x 5 mm; y-form; titanium	
5.9322.38	mini T-plate with conical thread 2.0/2.0; 3/8 holes; 57 x 5 mm; y-form; titanium	

T plates 3.5

Standard; for screws Ø 3.5 mm; titanium



Item no. 5.817.33



Item no. 5.810.33



Item no. 5.812.33

Item no.	Item description	EAN
T plate 3.5 – plate thickness 1.2 mm		
5.817.33	T-plate 3.5/3.5; 3/3 holes; 50 x 10 mm; rectangular; titanium	4 047075 009640
5.817.34	T-plate 3.5/3.5; 3/4 holes; 56 x 10 mm; rectangular; titanium	4 047075 009411
5.817.35	T-plate 3.5/3.5; 3/5 holes; 67 x 10 mm; rectangular; titanium	4 047075 009671
5.817.36	T-plate 3.5/3.5; 3/6 holes; 78 x 10 mm; rectangular; titanium	4 047075 009688
5.817.37	T-plate 3.5/3.5; 3/7 holes; 89 x 10 mm; rectangular; titanium	4 047075 009510
5.817.38	T-plate 3.5/3.5; 3/8 holes; 100 x 10 mm; rectangular; titanium	4 047075 009701
5.817.39	T-plate 3.5/3.5; 3/9 holes; 111 x 10 mm; rectangular; titanium	4 047075 009657
5.817.43	T-plate 3.5/3.5; 4/3 holes; 50 x 11 mm; rectangular; titanium	4 047075 009664
5.817.44	T-plate 3.5/3.5; 4/4 holes; 56 x 11 mm; rectangular; titanium	4 047075 009732
5.817.45	T-plate 3.5/3.5; 4/5 holes; 67 x 11 mm; rectangular; titanium	4 047075 009749
5.817.46	T-plate 3.5/3.5; 4/6 holes; 78 x 11 mm; rectangular; titanium	4 047075 009756
5.817.47	T-plate 3.5/3.5; 4/7 holes; 89 x 11 mm; rectangular; titanium	4 047075 009763
5.817.48	T-plate 3.5/3.5; 4/8 holes; 100 x 11 mm; rectangular; titanium	4 047075 009534
T plate 3.5 bent – plate thickness 1.2 mm		
5.810.33	T-plate 3.5/3.5; 3/3 holes; 50 x 10 mm; head bent; titanium	4 047075 008964
5.810.35	T-plate 3.5/3.5; 3/5 holes; 67 x 10 mm; head bent; titanium	4 047075 009046
5.810.44	T-plate 3.5/3.5; 4/4 holes; 56 x 11 mm; head bent; titanium	4 047075 009039
5.810.46	T-plate 3.5/3.5; 4/6 holes; 78 x 11 mm; head bent; titanium	4 047075 009329
T plate 3.5 scew long hole – plate thickness 1.5 mm		
5.812.33	T-plate 3.5/3.5; 3/3 holes; 52 x 10 mm; oblique; 2 long hole in shank; titanium	4 047075 009343
5.812.34	T-plate 3.5/3.5; 3/4 holes; 63 x 10 mm; oblique; 2 long hole in shank; titanium	4 047075 009527
5.812.35	T-plate 3.5/3.5; 3/5 holes; 74 x 10 mm; oblique; 2 long hole in shank; titanium	4 047075 009473
5.812.36	T-plate 3.5/3.5; 3/6 holes; 85 x 10 mm; oblique; 2 long hole in shank; titanium	4 047075 009541
5.812.37	T-plate 3.5/3.5; 3/7 holes; 96 x 10 mm; oblique; 2 long hole in shank; titanium	4 047075 009558
5.812.38	T-plate 3.5/3.5; 3/8 holes; 107 x 10 mm; oblique; 2 long hole in shank; titanium	4 047075 009565

T plates 3.5

Standard; for screws Ø 3.5 mm; stainless steel



Item no. 4.817.33



Item no. 4.812.33

Item no.	Item description	EAN
T plate 3.5 – plate thickness 1.2 mm		
4.817.33	Tplate 3.5/3.5; 3/3 holes; 50 x 10 mm; rectangular; stainless steel	4 047075 049868
4.817.34	Tplate 3.5/3.5; 3/4 holes; 56 x 10 mm; rectangular; stainless steel	4 047075 049875
4.817.35	Tplate 3.5/3.5; 3/5 holes; 67 x 10 mm; rectangular; stainless steel	4 047075 049721
4.817.36	Tplate 3.5/3.5; 3/6 holes; 78 x 10 mm; rectangular; stainless steel	4 047075 049967
4.817.37	Tplate 3.5/3.5; 3/7 holes; 89 x 10 mm; rectangular; stainless steel	4 047075 049561
4.817.38	Tplate 3.5/3.5; 3/8 holes; 100 x 10 mm; rectangular; stainless steel	4 047075 049639
4.817.43	Tplate 3.5/3.5; 4/3 holes; 50 x 10 mm; rectangular; stainless steel	4 047075 049646
4.817.44	Tplate 3.5/3.5; 4/4 holes; 56 x 11 mm; rectangular; stainless steel	4 047075 049653
4.817.45	Tplate 3.5/3.5; 4/5 holes; 67 x 11 mm; rectangular; stainless steel	4 047075 049738
4.817.46	Tplate 3.5/3.5; 4/6 holes; 78 x 11 mm; rectangular; stainless steel	4 047075 049684
4.817.47	Tplate 3.5/3.5; 4/7 holes; 89 x 11 mm; rectangular; stainless steel	4 047075 049752
4.817.48	Tplate 3.5/3.5; 4/8 holes; 100 x 11 mm; rectangular; stainless steel	4 047075 049769
T plate 3.5 skew long hole – plate thickness 1.5 mm		
4.812.33	Tplate 3.5/3.5; 3/3 holes; 52 x 10 mm; oblique; 2 long hole in shank; stainless steel	4 047075 050208
4.812.34	Tplate 3.5/3.5; 3/4 holes; 63 x 10 mm; oblique; 2 long hole in shank; stainless steel	4 047075 049745
4.812.35	Tplate 3.5/3.5; 3/5 holes; 74 x 10 mm; oblique; 2 long hole in shank; stainless steel	4 047075 049790
4.812.36	Tplate 3.5/3.5; 3/6 holes; 85 x 10 mm; oblique; 2 long hole in shank; stainless steel	4 047075 049806
4.812.37	Tplate 3.5/3.5; 3/7 holes; 96 x 10 mm; oblique; 2 long hole in shank; stainless steel	4 047075 049813
4.812.38	Tplate 3.5/3.5; 3/8 holes; 107 x 10 mm; oblique; 2 long hole in shank; stainless steel	4 047075 049899

INSTRUMENTS

Königsee Implantate

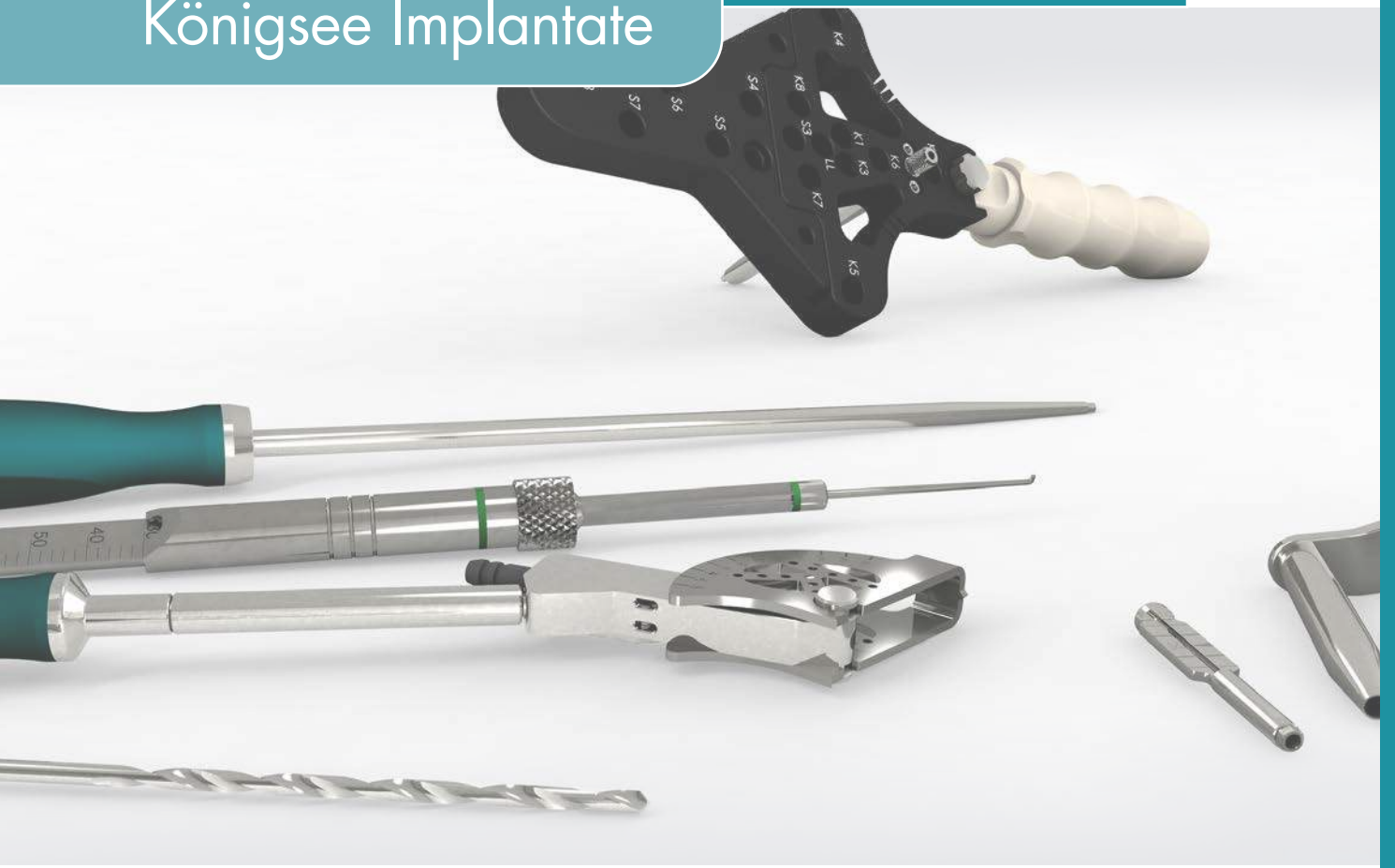

Your Partner in Osteosynthesis



Königsee Implantate

Königsee Implantate GmbH

OF-Aschau / Am Sand 4

D-07426 Allendorf

Tel.: 036738 498-0

Fax: 036738 498-19

Web: www.koenigsee-implantate.de

Mail: info@koenigsee-implantate.de

3D-Osteotomielehre

Artikel-Nr.	Bezeichnung
10.800.00	3 D-Osteotomielehre für Umstellungsosteotomie; komplett
10.800.10	Bohrlehre für 3D-Osteotomielehre

Zusammenfassung

Bei mehrdimensionalen Osteotomien der Intertrochanterregion können intraoperativ Schwierigkeiten auftreten. Vergleicht man die präoperativ vorgenommene Planung mit dem operativen Ergebnis, so unterscheidet sich diese mitunter. Eine speziell entwickelte "Multidirektionale Osteotomielehre" für intertrochantere dreidimensionale Osteotomien trägt zur Lösung dieses Problems bei. Mit diesem Instrument können ein- oder mehrdimensionale intertrochantäre Umstellungsosteotomie technisch einfach und mit hoher Übereinstimmung zwischen geplanter und erzielter Osteotomieebene umgesetzt werden. Während der Erprobung zeigte sich, dass sich die Indikationsbreite der Osteotomielehre auch generell auf die Korrektur anderer Achsenfehlstellungen langer Röhrenknochen erweitern lässt.

Indikation

Korrekturoperationen bei Achsendeformitäten an langen Röhrenknochen, insbesondere intertrochantere bei erworbenen oder angeborenen Varus/Valgus- oder Flexions/Extensionsabweichungen des Schenkelhalses, korrekturbedürftiger Abrutsch nach Epiphyseolysis capitis femoris, bestimmte Formen der Osteonekrose des Hüftkopfes sowie posttraumatischer Fehlstellungen.



Wir hoffen, dass unser Angebot Ihren Vorstellungen entspricht.
Über Ihren Auftrag würden wir uns sehr freuen.

Mit freundlichen Grüßen

Königsee Implantate GmbH



Königsee
Implantate

Königsee Implantate GmbH

OFAschau / Am Sand 4

D-07426 Allendorf

Tel.: 036738 498-0

Fax: 036738 498-19

Web: www.koenigsee-implantate.de

Mail: info@koenigsee-implantate.de

Bending device for variable angle-stable Reco-plates - small fragment

item no.	Item designation
2.911.06	Bending device*, Smallfragment for variable angle-stable Reco-plates

* For the handling during bending 2 pieces need to be used.

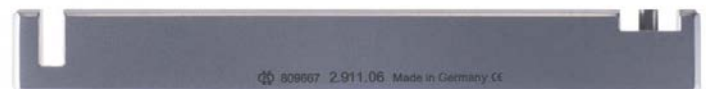

pic.: 2.911.06

We hope, this offer meets your expectations
and we would be happy to receive your order.

With kind regards



Königsee Implantate

Königsee Implantate GmbH

OT-Aschau / Am Sand 4

D-07426 Allendorf

Tel.: 036738 498-0

Fax: 036738 498-559

Web: www.koenigsee-implantate.de

Mail: info@koenigsee-implantate.de

Bending lever for variable angle-stable Reco-plates D 2.7mm

item no.	Item designation
2.911.07	Bending lever*, for variable angle-stable Reco-plates D 2.7mm

* Please pay attention when ordering:
For the handling during bending 2 pieces need to be used.



pic.: 2.911.07

We hope, this offer meets your expectations
and we would be happy to receive your order.

With kind regards























Königsee Implantate GmbH

Drill guide

drill sleeve, tissue protecting sleeve



Item no. 10.500.27 2.977.01 2.977.02 2.977.04 2.977.05 2.977.08 10.269.94

Item no.	Item description	EAN
Drill guide with handle for standard screwing		
10.500.27A	drill guide with handle for small fragment; handle length 55 mm	
10.500.27	drill guide with handle for small fragment; handle length 45 mm	
10.500.27S2	drill guide with handle for small fragment; handle length 40 mm	
Drill guide for angle stable screwing		
2.977.01	drill guide for angle stable screwing; length 45 mm; small fragment	
2.977.02	drill guide for angle stable screwing; length 70 mm; big fragment	
2.977.04	drill guide for angle stable screwing; length 68 mm; small fragment	
2.977.05	drill guide for angle stable screwing 2.0 mm; length 30 mm	
2.977.06	drill guide for angle stable screwing 2.0 mm; length 45 mm	
2.977.06a	drill guide for angle stable screwing 2.0 mm; length 45 mm	
2.977.11	drill guide for angle stable screwing 2.7 mm; length 44 mm	
2.977.11/3	drill guide for angle stable screwing 2.7 mm; length 44 mm; single thread with knurl	
2.977.13	drill guide for angle stable screws 3.5 mm with head Ø 5.0 mm; length 44 mm	
2.977.15	drill guide for angle stable screwing 5.5 mm; length 70 mm	
2.977.16	drill guide for angle stable screwing 4.0 mm; length 68 mm	
Drill guide with handle for variable angle stable screwing		
2.977.08	drill guide with handle for variable angle stable screwing mm; small fragment; length 45 mm	
2.977.09	drill guide with handle for variable angle stable screwing mm; small fragment; length 68 mm	
2.977.10	drill guide with handle for variabel angle stable screwing; length 45 mm; MF	
2.977.12	drill guide with handle for variable angle stable screwing 3.5 mm with head Ø 5.0 mm	
2.977.14	drill guide for variabel angle stable screwing 2.0 mm; length 45 mm	
2.977.17	drill guide with handle for variabel angle stable screwing 4.0 mm; length 68 mm	
2.977.19	drill guide with handle for variabel angle stable screwing 2.7 mm; length 42 mm	
10.269.94	drill guide for variable angle stable screwing for drill Ø 3.2 mm for RoSA	

Drill guide

drill sleeve, tissue protecting sleeve



Item no. 2.9771.35





















Item no. 10.270.23



Item no. 10.520.30



Item no. 10.500.21

Item no.	Item description	EAN
Drill guide with handle for variable angle stable screwing		
10.500.24	drill guide with handle for standard screwing 2.4 mm; length 45 mm	
2.9774.30	sinkhole drill guide for drill Ø 3.0 mm	
Drill guide for angle stable compression hole		
2.9771.35	drill guide for angle stable compression hole; small fragment	
2.9771.45	drill guide for angle stable compression hole; big fragment	
Drill guide for guide frame		
10.270.22	drill bush Ø 1.6 mm; Ø 10 x 145 mm; lØ 1.7 mm f. aiming device f. prox. hum. pl. 5.07913.8X	
10.270.23	drill bush Ø 2.5 mm; Ø 10 x 145 mm; lØ 2.7 mm f. aiming device f. prox. hum. pl. 5.07913.8X	
10.270.24	drill bush Ø 3.0 mm; Ø 10 x 145 mm; lØ 3.2 mm f. aiming device f. prox. hum. pl. 5.07913.8X	
10.176.11/1	drill guide for guide frame; Ø 8.0 x 167 mm; lØ 3.3 mm	
10.176.11/3	drill guide for femur guide; lØ 4.2 mm for screws Ø 5.5 mm	
10.176.18	drill guide for guide frame; Ø 8.0 x 105 mm; lØ 4.2 mm	
10.176.20	drill guide for guide frame; Ø 10 x 40 mm; lØ 1.8 mm	
10.176.21	drill guide for guide frame; Ø 8.0 x 171 mm; lØ 1.8 mm	
10.176.22	drill guide for guide frame; Ø 8.0 x 105 mm; lØ 3.3 mm	
Double drill guide; spring bushing		
10.520.30	double drill guide Ø 2.5 mm/Ø 3.5 mm; spring bushing	
Drill guide for neutral and compression position		
10.500.01	DC-drill guide; inside Ø 3.2 mm; for screws Ø 4.5 mm	
10.500.04	drill guide for neutral and compression position; Ø 2.5 mm	
10.500.20	drill guide for neutral and compression position; Ø 3.2 mm; inset 45 mm	
10.500.21	drill guide for neutral and compression position; Ø 3.2 mm	

Drill guide

drill sleeve, tissue protecting sleeve



Item no. 10.500.11



Item no. 10.502.45



Item no. 10.945.00



Item no. 10.520.20

Item no.	Item description	EAN
Double drill guide		
10.500.02	double drill guide; Ø 3.2 mm/ Ø 4.5 mm	4 047075 075089
10.500.03	double drill guide; Ø 1.25 mm/ Ø 2.7 mm	4 047075 075096
10.500.05	double drill guide; Ø 3.2 mm/ Ø 6.5 mm	4 047075 074983
10.500.07	double drill guide; Ø 1.1 mm/ Ø 1.5 mm	4 047075 075140
10.500.08	double drill guide; Ø 1.5 mm/ Ø 2.0 mm	4 047075 075003
10.500.09	double drill guide; Ø 2.0 mm/ Ø 2.7 mm	4 047075 075010
10.520.35	double drill guide; Ø 2.5 mm/ Ø 3.5 mm	4 047075 075522
Universal drill guide		
10.500.11	drill guide Ø 3.2 mm	4 047075 075027
10.502.32	universal drill guide; Ø 3.2 mm	4 047075 075201
10.502.45	universal drill guide; Ø 4.5 mm	4 047075 075218
Percutaneous drill bush system		
10.927.00	percutaneous drill bush system for cannulated screws Ø 2.7 mm	4 047075 076062
10.935.00	percutaneous drill bush system for cannulated screws Ø 3.5 mm	4 047075 075935
10.940.00	percutaneous drill bush system for cannulated screws Ø 4.0 mm	4 047075 075799
10.945.00	percutaneous drill bush system for cannulated screws Ø 4.5 mm	4 047075 076093
10.965.00	percutaneous drill bush system for cannulated screws Ø 6.5 mm	4 047075 076000
10.970.00	percutaneous drill bush system for cannulated screws Ø 7.0 mm	4 047075 075881
10.975.00	percutaneous drill bush system for cannulated screws Ø 7.5 mm	4 047075 165780
Triple drill guide		
10.520.20	triple drill guide Ø 2.0 mm	4 047075 075614
10.520.25	triple drill guide Ø 2.5 mm; for mini fragment and small fragment	4 047075 075515

Drill guide

drill sleeve, tissue protecting sleeve



Item no. 2.960.03





















Item no. 10.510.35



Item no. 10.269.83



Item no. 2.9775.24

Item no.	Item description	EAN
Parallel aiming device for guide wire Ø 2.0 mm		
2.960.03	parallel aiming device for guide wire Ø 2.0 mm	
Inserting drill guide		
10.510.27	inserting drill guide; Ø 2.7 mm/ Ø 2.0 mm	
10.510.35	inserting drill guide; Ø 3.5 mm/ Ø 2.5 mm	
10.510.45	inserting drill guide; Ø 4.5 mm/ Ø 3.2 mm	
Drill guide with scaling		
10.269.83	universal drill guide with scaling; Ø 3.2 mm for RoSA	
10.269.84	drill guide with scaling for angle stable screwing for drill Ø 3.2 mm	
2.9775.24	drill guide; Ø 2.4 mm double cone; angle-stable	
KFN-drill guide		
10.261.011	drill guide; Ø 8.0 x 150 mm; indented; silver	
10.261.031	drill guide; Ø 4.8 x 160 mm; silver	
10.264.20	tissue protecting drill sleeve for intramedullary reamer; Ø 20 x 107 mm; inside Ø 17.2 mm	
10.264.21	sleeve for intramedullary reamer; Ø 17 mm/ Ø 3.2 x 121 mm	
10.264.22	trocar for sleeve for intramedullary reamer; Ø 3.0 x 132 mm	
10.264.05	sleeve for supporting screw; Ø 16 mm/ Ø 14 x 200 mm	
10.264.06	sleeve for supporting screw; Ø 14 mm/ Ø 2.7 x 211 mm	
10.264.07	trocar for sleeve for supporting screw; Ø 2.5 x 222 mm	
10.264.12	sleeve for anti-rotation screw; Ø 8.8 mm/ Ø 6.7 x 198 mm	
10.264.14	sleeve for anti-rotation screw; Ø 6.5 mm/ Ø 2.2 x 205 mm	
10.264.15	trocar for sleeve for anti-rotation screw; Ø 2.0 x 215 mm	

Drill guide

drill sleeve, tissue protecting sleeve



Item no. 10.261.01



Item no. 10.266.034



Item no. 10.266.03

Item no.	Item description	EAN
Frako/DENS-drill guide		
2.956.42	tissue protecting drill sleeve; Ø 6.0 x 30 mm; inside Ø 4.2 mm	4 047075 084487
10.266.03	double tissue protecting drill sleeve; Ø 7.0 x 140 mm; inside Ø 4.2 mm	4 047075 144624
10.266.034	tubes for double tissue protecting drill sleeve	4 047075 148158
DET-drill guide		
10.261.01	drill guide; Ø 8.0 x 150 mm; green	4 047075 073566
10.261.02	drill guide; Ø 2.1 x 160 mm; silver	4 047075 073467
10.261.03	drill guide; Ø 4.8 x 160 mm; blue	4 047075 073658



Königsee Implantate

Königsee Implantate GmbH

OF-Aschau / Am Sand 4

D-07426 Allendorf

Tel.: 036738 498-0

Fax: 036738 498-559

Web: www.koenigsee-implantate.de

Mail: info@koenigsee-implantate.de

Overview Königsee taps

Item N°	Item designation
2.923.35	tap for quick coupling, \varnothing 3.5, length 160, cannulated, inside \varnothing 1.5
2.923.45	tap with handle, \varnothing 4.5, length 135, cannulated, inside \varnothing 1.75
2.924.15	tap for dental coupling for cortical screws, \varnothing 1.5, length 50
2.924.20	tap for dental coupling for cortical screws, \varnothing 2.0, length 53
2.924.27	tap for quick coupling for cortical screws, \varnothing 2.7, length 100
2.924.35	tap for quick coupling for cortical screws, \varnothing 3.7, length 110
2.924.45	tap for quick coupling for cortical screws, \varnothing 4.5, length 130, thread 25
2.925.35	tap for quick coupling for cancellous screws, \varnothing 3.5, length 110
2.925.45	tap for quick coupling for cortical screws, \varnothing 4.5, length 130, thread 70
2.927.40	tap for quick coupling for cancellous screws, \varnothing 4.0, length 130
2.927.45	tap for quick coupling for cortical screws, \varnothing 4.5, length 195, thread 70
2.927.65	tap for quick coupling for cancellous screws, \varnothing 6.5, length 170, thread 120
20.149.80	sorting bank, 230 x 107, for tap \varnothing 3.5 to \varnothing 6.5

pic.

sorting bank Königsee taps for storage of Code-
No. : 2.924.35, 2.927.40, 2.925.45,
2.927.45, 2.927.65)



We hope, this offer meets your expectations
and we would be happy to receive your order.

With kind regards
Königsee Implantate GmbH



Königsee Implantate

Königsee Implantate GmbH

OFAschau / Am Sand 4

D-07426 Allendorf

Tel.: 036738 498-0

Fax: 036738 498-19

Web: www.koenigsee-implantate.de

Mail: info@koenigsee-implantate.de

Drill bit for dental coupling Ø 1.5 x 105 mm

Item no.	Item description
2.904.20DK	drill bit for dental coupling, Ø1.5, length 105 mm, spiral length 30 mm, double spiral

We hope, this offer meets your expectations
and we would be happy to receive your order.

With kind regards

Königsee Implantate GmbH

Königsee Implantate GmbH

19/07/2013/KaMo



Königsee Implantate

Königsee Implantate GmbH

OFAschau / Am Sand 4

D-07426 Allendorf

Tel.: 036738 498-0

Fax: 036738 498-559

Web: www.koenigsee-implantate.de

Mail: info@koenigsee-implantate.de

Overview

Königsee drill bits

Item no.	Item description
2.904.01	Drill bit Ø 1,1; length 65 mm, spiral length 16
2.904.02	Drill bit Ø 1,5; length 88 mm, spiral length 25
2.904.03	Drill bit Ø 2,0; length 105 mm, spiral length 30
2.904.04	Drill bit Ø 2,0; length 125 mm, spiral length 30
2.904.05	Drill bit Ø 2,5; length 105 mm, spiral length 50
2.904.05/gold	Drill bit Ø 2,5; length 105 mm /TIN beschichtet
2.904.06	Drill bit Ø 2,5; length 125 mm, spiral length 60
2.904.07	Drill bit Ø 2,7; length 105 mm, spiral length 50
2.904.08	Drill bit Ø 3,2; length 145 mm, spiral length 60
2.904.09	Drill bit Ø 3,2; length 195 mm, spiral length 60
2.904.10	Drill bit Ø 3,5; length 110 mm, spiral length 40
2.904.11	Drill bit Ø 3,5; length 195 mm, spiral length 60
2.904.12	Drill bit Ø 4,5; length 145 mm, spiral length 60
2.904.13	Drill bit Ø 4,5; length 195 mm, spiral length 85
2.904.19	Drill bit Ø 1,1; length 105 mm, spiral length 30
2.904.20	Drill bit Ø 1,5; length 105 mm, spiral length 30
2.904.20DK	Drill bit Ø 1,5; length 105 mm, spiral length 30
2.904.22	Drill bit Ø 2,5; length 155 mm, spiral length 60
2.904.23	Drill bit Ø 4,0; length 220 mm, spiral length 60
2.904.25	Drill bit Ø 3,0; length 155 mm, spiral length 60
2.905.27	Drill bit Ø 2,7; length 160 mm, cann., spiral length 30, IØ 1,35
2.905.32	Drill bit Ø 3,2; length 160 mm, cann., spiral length 60, IØ 1,75
2.905.35	Drill bit Ø 3,5; L 160 mm, cann., spiral length 30, IØ 1,35
2.905.45	Drill bit Ø 4,5; L 160 mm, cann., spiral length 60, IØ 1,8
2.905.46	Drill bit Ø 4,5; L 230 mm, cann., spiral length 60, IØ 2,1
20.149.70	sorting bank, 230 x 107, for drill bit Ø 2.0 to Ø 4.5

pic.

sorting bank Königsee drill bits for storage of Code-No.
2.904.03, 2.904.05, 2.904.07, 2.904.08,
2.904.09, 2.904.10, 2.904.12, 2.904.13,
2.905.32, 2.905.45)



We hope, this offer meets your expectations
and we would be happy to receive your order.

With kind regards
Königsee Implantate GmbH



Königsee Implantate

Königsee Implantate GmbH

OF-Aschau / Am Sand 4

D-07426 Allendorf

Tel.: 036738 498-0

Fax: 036738 498-559

Web: www.koenigsee-implantate.de

Mail: info@koenigsee-implantate.de

drill bit for boring damaged screws double spiral, DLC-coated

Item no.	Item description
2.9042.025	drill bit; Ø 2,5 x length 46 mm; spiral length 14 mm; double spiral; DLC-coated
2.9042.030	drill bit; Ø 3,0 x length 50 mm; spiral length 17 mm; double spiral; DLC-coated
2.9042.040	drill bit; Ø 4,0 x length 54 mm; spiral length 22 mm; double spiral; DLC-coated
2.9042.050	drill bit; Ø 5,0 x length 62 mm; spiral length 26 mm; double spiral; DLC-coated
2.9042.060	drill bit; Ø 6,0 x length 93 mm; spiral length 57 mm; double spiral; DLC-coated
2.9042.070	drill bit; Ø 7,0 x length 109 mm; spiral length 69 mm; double spiral; DLC-coated

DLC - Diamond-like carbon

Diamond-like carbon coating for optimal protection against wear and corrosion



pict.:2.9042.025

We hope, this offer meets your expectations
and we would be happy to receive your order.

With kind regards

Königsee Implantate GmbH

Screwdriver inset















with quick coupling



Item no. 2.941.15A

Item no. 2.9419.10

Item no. 2.941.35/195

Item no.	Item description	EAN
Hex screwdriver inset for internal hexagon  Internal hexagon		
2.941.15A	hex screwdriver inset for quick coupling for screw \varnothing 1.5 mm - \varnothing 2.0 mm; wrench width 1.5 mm; conic; length 100 mm	 4 047075 144792
2.941.25A	hex screwdriver inset for quick coupling for screw \varnothing 2.7 mm - \varnothing 4.0 mm; wrench width 2.5 mm; conic; length 100 mm	 4 047075 138654
2.943.40/S	hex screwdriver for quick coupling for screw \varnothing 2.7 mm - \varnothing 4.0 mm; wrench width 2.5 mm; cannulated; inside \varnothing 1.7 mm; length 100 mm	 4 047075 083664
2.941.35	hex screwdriver inset for quick coupling for screw \varnothing 4.5 mm - \varnothing 7.0 mm; wrench width 3.5 mm; length 100 mm	 4 047075 083411
2.941.35/135	hex screwdriver inset for quick coupling for screw \varnothing 4.5 mm - \varnothing 7.0 mm; wrench width 3.5 mm; length 135 mm	 4 047075 139286
2.941.35/195	hex screwdriver inset for quick coupling for screw \varnothing 4.5 mm - \varnothing 7.0 mm; wrench width 3.5 mm; length 195 mm	 4 047075 139293
2.941.3521	hex screwdriver inset for quick coupling for screw \varnothing 4.5 mm - \varnothing 7.0 mm; wrench width 3.5 mm; cannulated; inside \varnothing 2.1 mm; length 100 mm	 4 047075 113484
Screwdriver inset for six lobe  Six lobe		
2.9419.08	screwdriver inset for hexalobe 08; length 100 mm	 4 047075 175239
2.9419.08/55	screwdriver inset for hexalobe 08; length 55 mm	 4 047075 175703
2.9419.10	screwdriver inset for hexalobe 10; length 100 mm	 4 047075 175246
2.9419.10/55	screwdriver inset for hexalobe 10; length 55 mm	 4 047075 175710
2.9419.15	screwdriver inset for hexalobe 15; length 100 mm	 4 047075 175253
2.9419.15/55	screwdriver inset for hexalobe 15; length 55 mm	 4 047075 175727

Reamers

Counterbores, countersinks, hollow cutter, cutters for ring plates, Hallux cutter



Item no. 10.505.15

























Item no. 2.907.27



Item no. 2.9101.35



Item no. 2.9103.20

Item no.	Item description	EAN
Counterbores		
10.230.18	pin-countersink for three-jaw chuck	
Countersinks		
10.505.15	countersink for dental coupling, length 57, for screws Ø1.5 and Ø2.0	
10.505.40	countersink for quick coupling, length 72, for screws Ø2.7 / Ø3.5 / Ø4.0	
10.505.81	countersink for quick coupling, length 110, for screws Ø4.5 and Ø6.5	
10.505.80	countersink with T-handle, length 180, for screws Ø4.5 and Ø6.5	
Cannulated countersinks		
2.907.27	countersink, Ø5x160, cannulated, inside Ø1.5, for cannulated screws Ø2.7	
2.907.27/70	countersink, Ø5x70, cannulated, inside Ø1.5, for cannulated screws Ø2.7	
2.907.35	countersink, Ø5x160, cannulated, inside Ø1.3, for cannulated screws Ø3.5	
2.907.40	countersink, Ø6x160, cannulated, inside Ø1.8, for cannulated screws Ø4	
2.907.45	countersink, Ø6.5x160, cannulated, inside Ø1.75, for cannulated screws Ø4.5	
2.907.70	countersink, Ø8x160, cutter ln 19.5, cannulated, inside Ø2.1, for cannul.screws Ø6.5	
2.907.71	countersink, Ø8x160, cutter ln 37, cannulated, inside Ø2.1, for cannul.screws Ø6.5/Ø7	
Hollow cutter		
2.9101.15	hollow cutter with quick coupling for screws Ø1.5-Ø2.0	
2.9101.35	hollow cutter with quick coupling for screws Ø2.7-Ø4.0	
2.9101.45	hollow cutter with quick coupling for screws Ø4.5-Ø7.0	
2.9101.55	hollow cutter with quick coupling for screws Ø7.0-Ø7.5	
Cutters for ring plates		
2.9102.14	cutter 80° for quick coupling, for ring plate Ø 14.0	
2.9102.16	cutter 100° for quick coupling, for ring plate Ø 16.0	
Hallux cutters		
2.9103.20	hallux cutter set, cutter convex, Ø 20	
2.9103.22	hallux cutter set, cutter concave, Ø 22	
2.9103.25	hallux cutter set, cutter convex, Ø 25	
2.9103.27	hallux cutter set, cutter concave, Ø 27	

Handle

with quick coupling



Item no. 10.305.05



Item no. 2.9345.15



Item no. 2.9345.35

Item no.	Item description	EAN
T-handle with quick coupling; metal		
10.305.05	T-handle with quick coupling; length 93.5 mm	4 047075 074211
10.306.06	T-handle with quick coupling; length 93.5 mm; cannulated; inside Ø 2.5 mm	4 047075 074334
handle with quick coupling; plastic		
10.306.01	handle with quick coupling; length 146 mm; cannulated; inside Ø 2.5 mm	4 047075 074433
torque screwdriver handle		
2.934.15	torque screwdriver handle; 0.7 newtonmeter	4 047075 138548
2.934.25	torque screwdriver handle; 2.2 newtonmeter	4 047075 138555
2.9345.15	torque screwdriver handle; 0.7 newtonmeter	4 047075 166404
2.9345.24	torque screwdriver handle; 1.5 newtonmeter	4 047075 172726
2.9345.25	torque screwdriver handle; 2.2 newtonmeter	4 047075 166411
2.9345.35	torque screwdriver handle; 4.8 newtonmeter	4 047075 166428

Handle with 1/4" - quick coupling

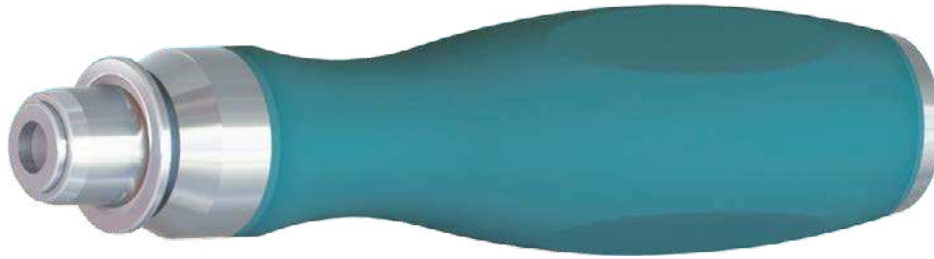

pict. 10.307.03

Item no.	Item description
10.307.03	Handle with 1/4" coupling length 162 mm

We hope, this offer meets your expectations.
We would be happy to receive your order.



Königsee
Implantate

Königsee Implantate GmbH
OT Aschau | Am Sand 4
07426 Allendorf | Germany
Fon + 49 36738 498-0
Fax + 49 36738 498-559
E-Mail: info@koenigsee-implantate.de

For further information please visit:
www.koenigsee-implantate.de

Assembly Instruction Gauges

Gauge with measuring sleeve

2.953.51

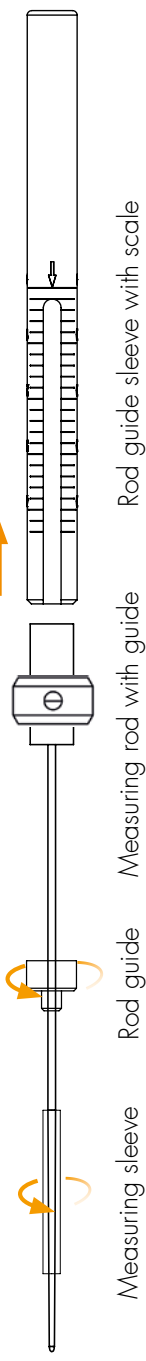

2.953.24

2.953.60

2.953.65

2.953.70

2.953.80

2.953.90

10.261.16

10.261.16F

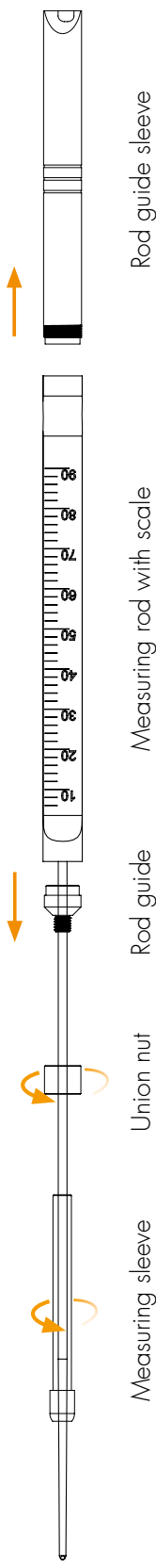

Gauge without measuring sleeve

2.953.15

2.953.27

2.953.35

2.953.45

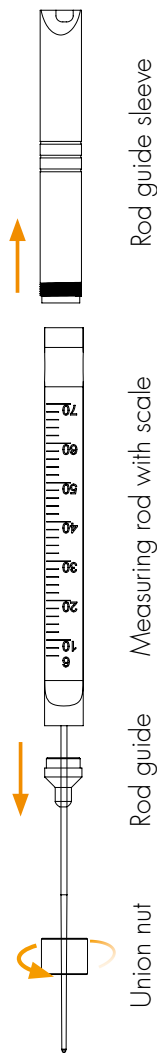

For the cleaning of gauges they have to be taken to pieces. (Shown in pictures above.)

The assembly takes place in reverse order.



Königsee Implantate

Königsee Implantate GmbH

OT-Aschau / Am Sand 4

D-07426 Allendorf

Tel.: 036738 498-0

Fax: 036738 498-559

Web: www.koenigsee-implantate.de

Mail: info@koenigsee-implantate.de

Metal eraser - The little helper -

Item no.	Item description
18.001.00	Metal eraser Poraflex Standard W 8, fine

product description

sparingly and efficiently eraser for metall and stainless steel for quick and easy cleaning of instruments and sensitive precision parts

application

This eraser removes unwanted oxyd deposit or soilings sensitive devices and instruments, in fine mechanics too.

characteristics

- no pollution is left behind; free of rubber
- unaffected by external influences , insensitive to extremes of temperature
- miniature format, comfortable and easy to handle, useable everywhere
- extremely long-lasting, very wear-resistant

We hope, this offer meets your expectations
and we would be happy to receive your order.

With kind regards

Königsee Implantate GmbH

Königsee Implantate GmbH

22/07/2013/KaMo

Overview screwdriver for extraction

for screws with wrench size 1.5 / 2.5 / 3.5



pict.: 2.948.15A



pict.: 2.948.15

Item no.	Item description
----------	------------------

Screwdriver with T-handle for extraction of screws

2.948.15	screwdriver with T-handle for extraction of screws with wrench size 1.5
2.948.25	screwdriver with T-handle for extraction of screws with wrench size 2.5
2.948.35	screwdriver with T-handle for extraction of screws with wrench size 3.5

Screwdriver for extraction of screws

2.948.15A	screwdriver for extraction of screws for quick coupling, wrench size 1.5
2.948.25A	screwdriver for extraction of screws for quick coupling, wrench size 2.5
2.948.35A	screwdriver for extraction of screws for quick coupling, wrench size 3.5

We hope this offer meets your expectations.
We would be happy to receive your order.

Screwdriver with handle



Item no. 10.264.29



Item no. 2.930.35



























Item no. 2.940.35/260



Item no. 2.9406.25

Item no.	Item description	EAN
----------	------------------	-----

Screwdriver for internal hexagon Internal hexagon

10.1776.07	hex screwdriver with handle for screw anchor,wrench width 2.5,conical	
10.264.03	hex screwdriver with handle and holding sleeve,wrench width 3.5	
10.264.17	hex screwdriver with handle,cannulated,inside Ø2.2,wrench width 3.5	
10.264.29	hex screwdriver with T-handle,wrench width 8	
10.266.02	hex screwdriver with handle,wrench width 2,length 350,cannulated,inside Ø1.3	
10.2705.40	hex screwdriver for Ø3.5 and Ø4.0;wrench size 2.5;conical;length 315mm	
2.930.25	hex screwdriver with T-handle,wrench width 2.5	
2.930.35	hex screwdriver with T-handle for screw Ø4.5 until Ø7.0,length 232	
2.940.15A	hex screwdriver with handle for screw Ø1.5 and Ø2.0,wrench width 1.5,conical	
2.940.25SA	hex screwdriver with handle for screw Ø2.7 until Ø4.0,wrench width 2.5,conical	
2.940.35	hex screwdriver w.handle for screws Ø4.5 until Ø7.0,length 215,wrench width 3.5	
2.940.35/260	hex screwdriver w.handle for screw Ø4.5 until Ø7.0,length 260,wrench width 3.5	
2.9401.15	hex screwdriver with divided handle for screw Ø1.5 and Ø2.0,wrench width 1.5	
2.9401.15A	hex screwdriver with handle for screw Ø1.5 and Ø2.0,wrench width 1.5,detachable	
2.9405.15	hex screwdriver for Ø1.5 and Ø2.0;wrench size 1.5;conical;length 215mm	
2.9405.25	hex screwdriver for Ø2.7 - Ø4.0;wrench size 2.5;conical;length 215mm	
2.9405.35	hex screwdriver for Ø4.5 - Ø7.0;wrench size 3.5;length 215mm	
2.9406.15	hex screwdriver with handle for screws Ø1.5-Ø2.0,AF1.5,conical	
2.9406.25	hex screwdriver with handle for screws Ø2.7-Ø4.0,AF2.5,conical	
2.9406.25/1	hex screwdriver with handle for screw Ø2.7-Ø4.0,wrench width 2.5,short,conical	
2.9406.35	hex screwdriver with handle for screws Ø4.5-Ø7.0,AF3.5,length 215	
2.9406.35/260	hex screwdriver with handle for screws Ø4.5-Ø7.0,AF3.5,length 260	
2.942.02	hex screwdriver with T-handle for screw Ø4.5 until Ø7.0,cannulated,inside Ø2.2	
2.943.25	hex screwdriver with handle for screw Ø2.7 until Ø4.0,cannulated,inside Ø1.3	
2.943.25/315	hex screwdriver with handle for screw Ø2.7 until Ø4.0,length 315,cannulated	

Screwdriver with handle



Item no. 2.9435.75

Item no. 2.9436.40

Item no. 2.9436.75

Item no. 2.9386.08

Item no.	Item description	EAN
2.943.35	hex screwdriver with handle for screw Ø4.5 until Ø7.0,cannulated,inside Ø2.2	4 047075 083725
2.943.35/L	hex screwdriver with handle for screw Ø4.5 until Ø7.0,length 275,cannulated	4 047075 083633
2.943.40/280	hex screwdriver with handle for screw Ø2.7 until Ø4.0,length 280,cannulated	4 047075 083657
2.943.40SA	hex screwdriver with handle for screw Ø2.7 until Ø4.0,cannul.,inside Ø1.7,conic	4 047075 117987
2.9435.75	hex screwdriver with handle for Ø7.5,cannulated,lØ2.9,wrench size 4,l 324mm	4 047075 168903
2.9436.20	hex screwdriver w.handle f.fracture compression;cann.;lØ1.3;wrench size 2;l215mm	4 047075 169986
2.9436.25	hex screwdriver with handle for Ø2.7-4;cannulated;lØ1.3;wrench size 2.5;l 215mm	4 047075 170005
2.9436.25/315	hex screwdriver with handle for Ø2.7-4;cannulated;lØ1.3;wrench size 2.5;l 315mm	4 047075 170012
2.9436.35	hex screwdriver with handle for Ø4.5-7;cannulated;lØ2.2;wrench size 3.5;l 215mm	4 047075 170029
2.9436.35/230	hex screwdriver with handle for Ø4.5-7;cannulated;lØ2.2;wrench size 3.5;l 230mm	4 047075 170036
2.9436.35/275	hex screwdriver with handle for Ø4.5-7;cannulated;lØ2.2;wrench size 3.5;l 275mm	4 047075 170043
2.9436.40	hex screwdriver with handle for Ø2.7-4;cannulated;lØ1.7;wrench size 2.5;l 215mm	4 047075 170050
2.9436.40/280	hex screwdriver with handle for Ø2.7-4;cannulated;lØ1.7;wrench size 2.5;l 280mm	4 047075 170067
2.9436.40/300	hex screwdriver with handle for Ø2.7-4;cannulated;lØ1.7;wrench size 2.5;l 300mm	4 047075 170074
2.946.15	hex screwdriver with holding sleeve for screw Ø1.5	4 047075 083817
2.946.15/1	hex screwdriver with handle,wrench width 1.5	4 047075 131693
2.946.25	hex screwdriver with handle and holding sleeve,wrench width 2.5	4 047075 083831
2.9465.15/1	hex screwdriver for Ø1.5 and Ø2.0;wrench size 1.5;length 184mm	4 047075 169313

Screwdriver for six lobe Six lobe

10.268.53	screwdriver;six-lobe 10	4 047075 163700
2.9381.06	screwdriver with handle for t 6,detachable	4 047075 144648
2.9381.08	screwdriver hexalobe size 8; PPSU-handle; L 139mm; detachable	4 047075 190461
2.9385.15	screwdriver with handle for six-lobe 15;length 215mm	4 047075 189472
2.9386.06	screwdriver with handle for six-lobe 6	4 047075 166466
2.9386.07	screwdriver with handle for six-lobe 7	4 047075 166473





Screwdriver

with handle



Item no. 2.9386.10

Item no. 2.93886.08

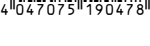
Item no.	Item description	EAN
2.9386.08	screwdriver with handle for six-lobe 8	 4 047075 166480
2.9386.10	screwdriver with handle for six-lobe 10	 4 047075 166497
2.9386.15	screwdriver with handle for six-lobe 15	 4 047075 166503
2.9386.25	screwdriver with handle for six-lobe 25	 4 047075 168194
2.93886.08	screwdriver hexalobe size 8; PPSU-handle; L 180 mm	 4 047075 190478

Screwdriver for extraction from shank for quick coupling



Item no. 2.9481.15



Item no. 2.9481.27



Item no. 2.9481.45









Item no. 2.9481.65



Item no. 2.9481.73

Item no.	Item description	EAN
----------	------------------	-----

Screwdriver for extraction from shank for quick coupling

2.9481.15	Screwdriver for extraction from shank of screws Ø 1.5 mm - Ø 2.0 mm for quick coupling	
2.9481.24	Screwdriver for extraction from shank of screws Ø 2.0 mm - Ø 2.7 mm for quick coupling	
2.9481.27	Screwdriver for extraction from shank of screws Ø 2.7 mm - Ø 4.0 mm for quick coupling	
2.9481.45	Screwdriver for extraction from shank of screws Ø 4.5 mm - Ø 6.0 mm for quick coupling	
2.9481.65	Screwdriver for extraction from shank of screws Ø 6.5 mm - Ø 7.0 mm for quick coupling	
2.9481.73	Screwdriver for extraction from shank of screws Ø 7.3 mm - Ø 7.5 mm for quick coupling	



Königsee Implantate

Königsee Implantate GmbH

OF-Aschau / Am Sand 4

D-07426 Allendorf

Tel.: 036738 498-0

Fax: 036738 498-559

Web: www.koenigsee-implantate.de

Mail: info@koenigsee-implantate.de

Overview side and power cutters

Item no.	Item description
6.906.01	head and side cutter for wires to maximum Ø1.7 mm
6.906.02	side cutter for wires to maximum Ø 2.2 mm
6.906.03	power cutter for wires to maximum Ø 3 mm (stainless steel) and Ø 4 mm (titanium)
6.906.06	power cutter for wires to maximum Ø 6 mm



We hope, this offer meets your expectations
and we would be happy to receive your order.

With kind regards

Königsee Implantate GmbH

SPASY™ Bone Cement Filler

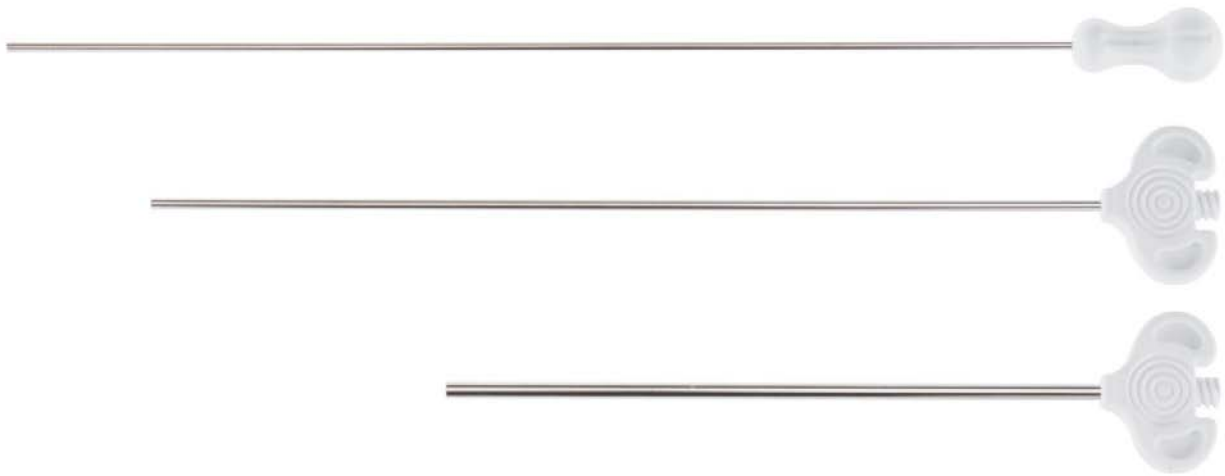

Item no.	Item description
D.71309.001	SPASY™ Bone Cement Filler

We hope, this offer meets your expectations.
We would be happy to receive your order.



19/06/2014/KaMo

Königsee Implantate GmbH
OT Aschau | Am Sand 4
07426 Allendorf | Germany
Fon + 49 36738 498-0
Fax + 49 36738 498-559
E-Mail: info@koenigsee-implantate.de

For further information please visit:
www.koenigsee-implantate.de



Königsee Implantate

Königsee Implantate GmbH

OF-Aschau / Am Sand 4

D-07426 Allendorf

Tel.: 036738 498-0

Fax: 036738 498-559

Web: www.koenigsee-implantate.de

Mail: info@koenigsee-implantate.de

Extraction forceps for wires and gliding nails

Code N°	Item designation
10.421.01	extraction forceps for wires; flat
10.421.02	extraction forceps for wires; round
10.421.05	extraction forceps with notch for wires Ø1.0 - 3.0 mm
10.421.06	extraction forceps for wires Ø1.0 - 2.0 mm
10.421.07	extraction forceps for wires Ø 2.0 - 3.0 mm



characteristics:

- high sturdiness
- firm lockability for a gentle extraction at the forearm
- narrow shape of plier-front for a minimal-invasive metal removal
- special shape configuration for a secure collection of especially short wire-ends and gliding nails

We hope, this offer meets your expectations
and we would be happy to receive your order.

With kind regards

Königsee Implantate GmbH

OVERVIEW

Königsee Implantate

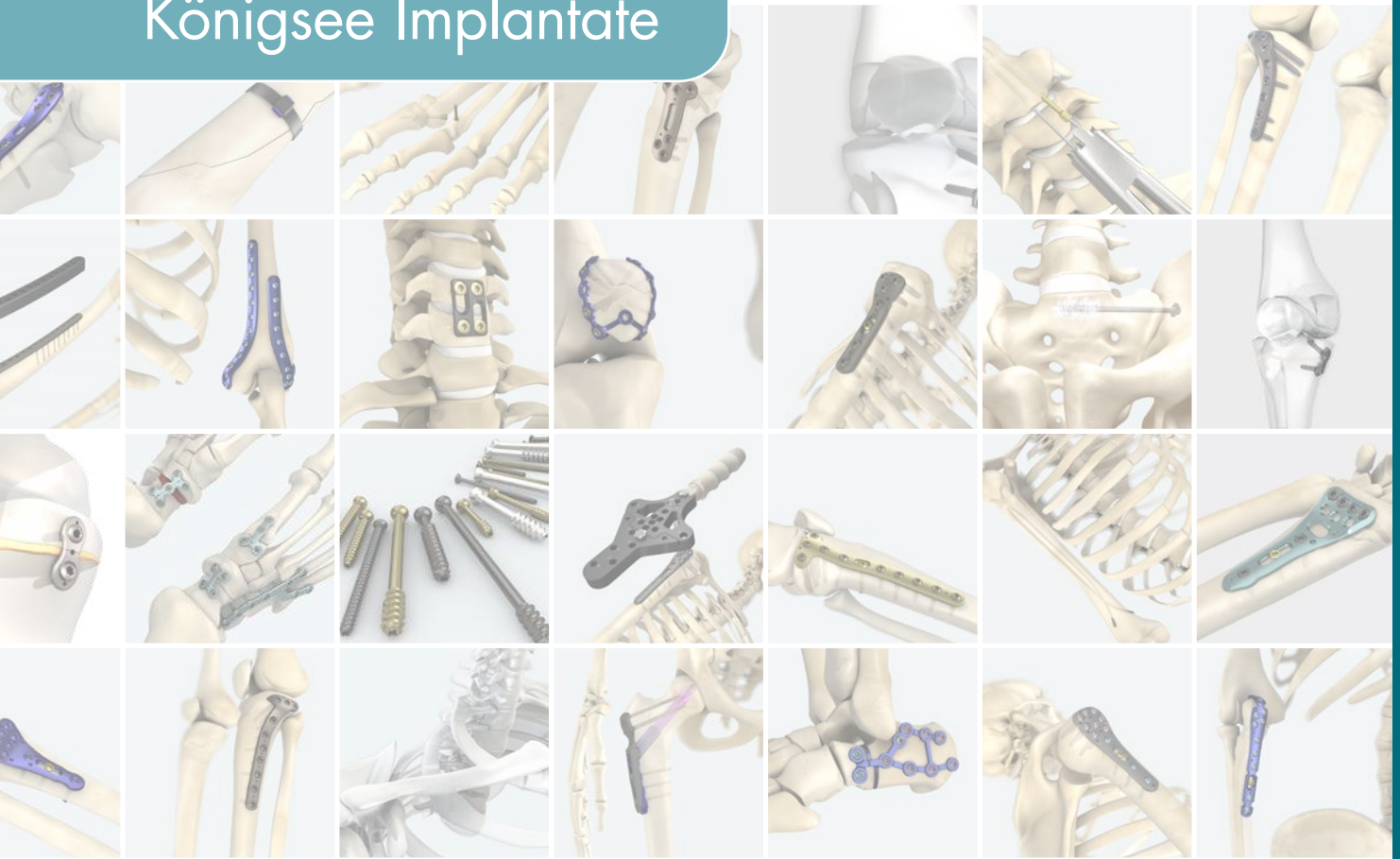

Your Partner in Osteosynthesis