

# Innovative Solutions in Medical Instruments



Plastic Surgery

## Life Time Guarantee.

All Professional precision instruments are guaranteed to be free of manufacturing and workmanship defects. Any instrument proved to be defective, excluding defects due to misuse or mishandling, shall be repaired or replaced free of cost. We recommend the use of proper and standard instruments cleaning, handling and preserving techniques to increase the life and functionality of all kinds of surgical instruments





**PA-37.15**  
15 cm / 6"

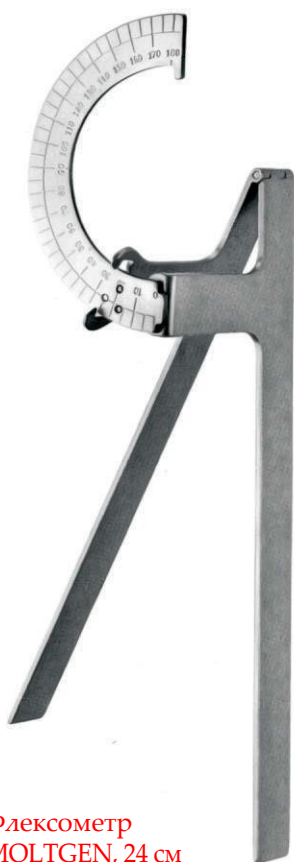

Флексометр  
MOLTGEN, 24 см

**PA-38.10**  
24 cm / 9½"

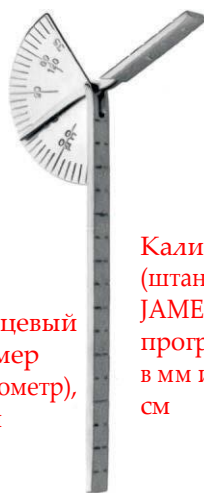

Пальцевый  
угломер  
(гониометр),  
13 см

**PA-38.30**  
13 cm / 5¼"

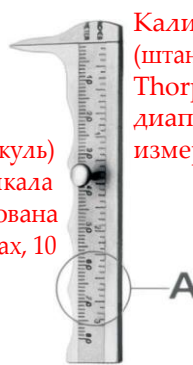

Калипер  
(штангенциркуль)  
Thorpe, 11 см,  
диапазон  
измерений 80 мм

**PA-38.40**  
10 cm / 4"

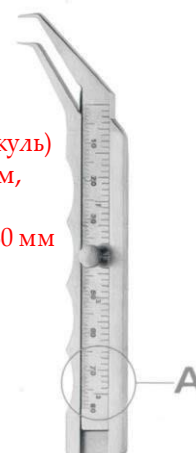

**PA-38.41**  
11 cm / 4¼"

**PA-37.20**  
20 cm / 8"

**PA-37.30**  
30 cm / 11¾"

**PA-37.50**  
50 cm / 19¾"

Линейка JOSEPH  
с ручкой, шкала  
проградуирована  
в мм и дюймах,  
17 см



JOSEPH  
**PAN-30.47**  
17 cm / 6¾"

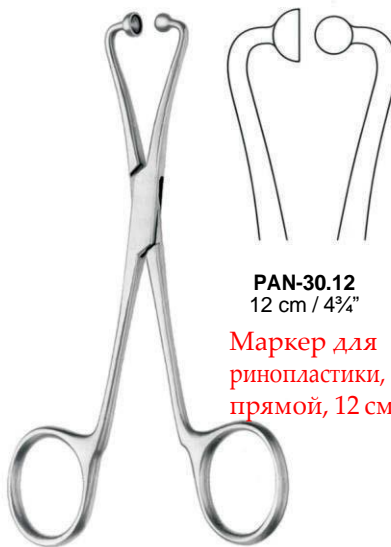

JOSEPH

**PAN-30.12**  
12 cm / 4¾"

Маркер для  
ринопластики,  
прямой, 12 см

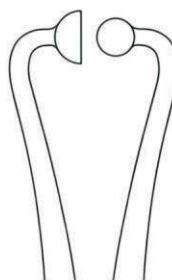

**PAN-30.14**  
14.5 cm / 5¾"

Маркер для  
ринопластики,  
прямой, 14.5  
см



KRETSCHMER  
**PAN-84.00**

Лин KRETSCHMER  
для набора для  
остеотомии верхней  
челюсти на уровне  
LE FORT I (упаковка  
10 шт)



KRETSCHMER  
**PAN-84.05**  
15 mm

Держатель для пина  
KRETSCHMER, для  
набора для остеотомии  
верхней челюсти на  
уровне LE FORT I, 15  
мм

Мерительный инструмент KNOCHEN MESSZIRKEL изгиба кости, для набора для остеотомии верхней челюсти на уровне LE FORT I, 19.5 см, острые зубцы



**PA-38.44**  
19.5 cm / 7<sup>3</sup>/<sub>4</sub>"



Сменный маркер для держателя PA-39.01, (упаковка 10 шт)



Держатель GUBISCH для сменных маркеров, для разметки линий разреза на коже/слизистой оболочке, 13 см

**GUBISCH**

**PA-39.02**  
Pen

**PA-39.01**  
13 cm / 5 1/8"  
Pen Holder



**CASTROVIEJO PAB-82.32**  
7 cm / 2<sup>3</sup>/<sub>4</sub>"

Калипер (штангенциркуль) CASTROVIEJO, шкала 20 мм, 7 см



**CASTROVIEJO PAB-82.41**  
9 cm / 3<sup>3</sup>/<sub>4</sub>"

Калипер (штангенциркуль) CASTROVIEJO, шкала 40 мм, 9 см

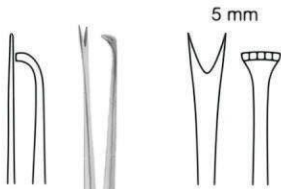

Маркер Pittanguy для фейслифтинга, ширина р/ч 5 мм, 16 см



**PITANGUY PAN-64.30**  
16 cm / 6<sup>1</sup>/<sub>4</sub>"



**CASTROVIEJO EPKER PAB-82.42**  
18 cm / 7 1/8"

Калипер (штангенциркуль) CASTROVIEJO EPKER, 18 см, прямой, 40 диапазон измерения 40 мм



**CASTROVIEJO EPKER PAB-82.43**  
18 cm / 7 1/8"

Калипер (штангенциркуль) CASTROVIEJO EPKER, 18 см, угловой, 40 диапазон измерения 40 мм



PROFESSIONAL Supercut scissors with their uniquely ground edges have with ultimate cutting efficiency. The special micro serrations in conjunction with the uniquely ground edges ensure precise, fine and minimally traumatising cuts. All our well-known models such as Metzenbaum, Mayo or Iris scissors are supplied with the supercut finish. Professional supercut scissors have a gold-coloured screw for ease of identification.

The range of supercut scissors from PROFESSIONAL comprises all models used routinely by surgeons: scissors for delicate and extremely delicate dissecting, e.g. Iris and Micro, models according to Metzenbaum in all possible lengths and designs, e.g. in a slim version for especially fine cutting to name but a few.

The supercut scissors can also be supplied with "TC" welded cutting edges of solid tungsten carbide alloy. The junction between the steel of the scissors and the tungsten carbide is seamless and homogenous. The welded cutting edges of solid tungsten carbide alloy guarantee excellent cutting quality and long life-span.

Ножницы хирургические Supercut от Professional Hospital Furnishers (PHF) с их уникальной зазубренной режущей частью - гарантия отличной эффективности в работе хирургов.

Специальная микро зазубренность лезвий Supercut гарантирует точные и минимально травмирующие диссекции.

Все наши известные модели, такие как Metzenbaum, Mayo или Iris поставляются с отделкой Supercut.

Для простоты идентификации ножницы Professional Hospital Furnishers (PHF) Supercut имеют винт золотого цвета.

Модельный ряд ножниц Supercut от Professional Hospital Furnishers (PHF) включает все модели, используемые обычно хирургами: ножницы для тонкой и чрезвычайно деликатной диссекции, например, Iris и Micro, модели Metzenbaum всех возможных размеров и исполнений, например, в тонкой версии для особо деликатной диссекции.

### Identification: Для простой идентификации ножниц используются следующие обозначения :

PROFESSIONAL TC scissors:  
gold-coloured rings

Ножницы TC с твердосплавными вставками из карбида вольфрама имеют кольца браншей золотистого цвета



PROFESSIONAL supercut scissors:  
one shaft completely gold plated

Ножницы Supercut с зазубренными лезвиями имеют один бранш полностью золотистого цвета



PROFESSIONAL supercut plus line scissors:  
one shaft completely gold plated and  
one ring gold plated

Ножницы Supercut Plus с твердосплавными вставками из карбида вольфрама и тонко зазубренными лезвиями имеют один бранш - полностью золотистого цвета, второй бранш - с кольцом золотистого цвета





IRIS

standard **PC-01.09**  
 supercut  
 TC  
 supercut plus



9cm/3 1/2"

**PC-01.10**



10.5cm/4 1/4"

**PC-01.110**



11.5cm/4 1/2"

**PC-01.11**  
**PC-01.111**  
**PC-05.61**  
**PC-05.161**



12.5cm/5"

**PC-01.12**



IRIS

supercut **PC-01.171**  
 TC **PC-05.71**  
 supercut plus **PC-05.171**



straight  
 11.5 cm / 4 1/2"

**PC-02.171**

curved  
 11.5 cm / 4 1/2"

**PC-02.171**

**PC-06.71**  
**PC-06.171**



MICRO IRIS

standard **PC-03.30**  
 supercut

straight  
 9 cm / 3 1/2"



**PC-04.30**

curved  
 9 cm / 3 1/2"

**PC-04.130**



IRIS

standard **PC-02.09**  
 supercut  
 TC  
 supercut plus



9cm/3 1/2"

**PC-02.10**



10.5cm/4 1/8"

**PC-02.11**

**PC-02.110**



11.5cm/4 1/2"

**PC-02.111**

**PC-06.61**  
**PC-06.161**



12.5cm/5"

**PC-02.12**

**PC-02.112**

**Delicate Dissecting Scissors**

Ножницы хирургические диссекционные РНГ

# Professional



STEVENS

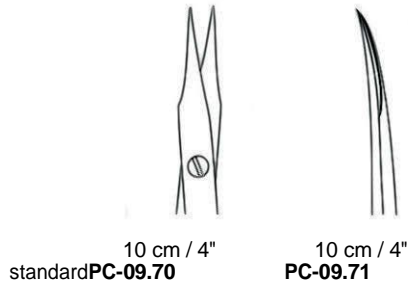

10 cm / 4"  
standard **PC-09.70**

10 cm / 4"  
**PC-09.71**

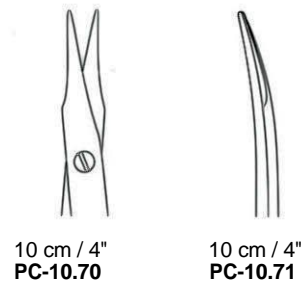

10 cm / 4"  
**PC-10.70**

10 cm / 4"  
**PC-10.71**



STEVENS

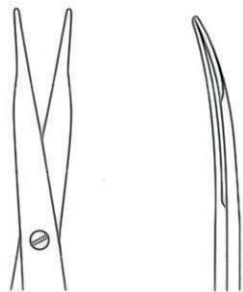

11.5 cm / 4 1/2"  
standard **PC-10.12**  
supercut **PC-10.112**

11.5 cm / 4 1/2"  
**PC-10.13**  
**PC-10.113**



STEVENS

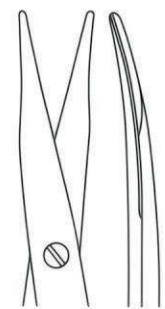

13 cm / 5 1/8"  
standard **PC-10.15**  
supercut **PC-10.115**



LEXER BABY

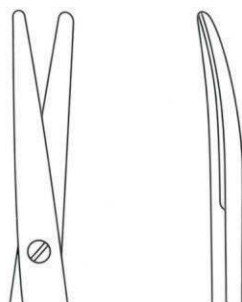

10 cm / 4"  
standard **PC-11.10**  
**TCPC-13.60**

10 cm / 4"  
**PC-12.10**  
**PC-13.61**



KNAPP

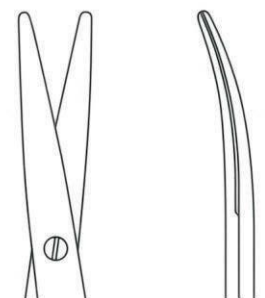

12.5 cm / 5"  
standard **PC-11.12**  
supercut **PC-11.112**  
**TCPC-12.62**

12.5 cm / 5"  
**PC-12.12**  
**PC-12.112**  
**PC-13.62**



KNAPP



12 cm / 4<sup>3</sup>/<sub>4</sub>"  
standard **PC-11.32**  
supercut **PC-11.132**



12 cm / 4<sup>3</sup>/<sub>4</sub>"  
**PC-12.32**  
**PC-12.132**



12 cm / 4<sup>3</sup>/<sub>4</sub>"  
**PC-11.52**



12 cm / 4<sup>3</sup>/<sub>4</sub>"  
**PC-12.52**



KNAPP



10 cm / 4"  
standard **PC-11.70**



10 cm / 4"  
**PC-12.70**



9.5cm / 5"  
standard **PC-12.90**

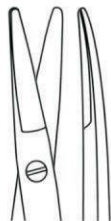

12.5cm / 5"  
standard **PAB-196.42**  
supercut **PAB-196.142**  
TC **PC-13.62**



12.5cm / 5"  
**PAB-196.43**  
**PAB-196.143**  
**PC-13.63**

## Delicate Dissecting Scissors

Ножницы хирургические диссекционные РНФ

# Professional



MAYO

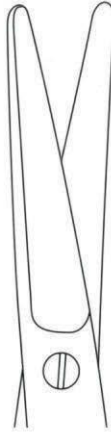

14 cm / 5½"

standard **PC-24.14**  
 supercut **PC-24.114**  
 TCPC-24.64  
 supercut plus **PC-24.164**



14 cm / 5½"

**PC-25.14**  
**PC-25.114**  
**PC-25.64**  
**PC-25.164**



17 cm / 6¾"

**PC-24.17**  
**PC-24.117**  
**PC-24.67**  
**PC-24.167**



17 cm / 6¾"

**PC-25.17**  
**PC-25.117**  
**PC-25.67**  
**PC-25.167**



MAYO STILLE

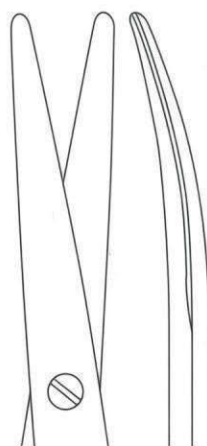

16 cm / 6¼"

standard **PC-30.15**  
 supercut **PC-30.115**  
 TCPC-31.65  
 supercut plus **PC-31.165**

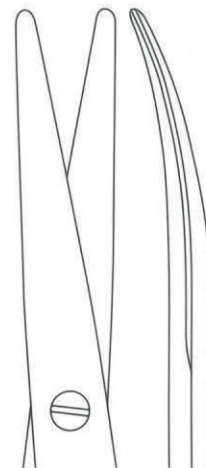

16 cm / 6¼"

**PC-30.17**  
**PC-30.117**  
**PC-31.67**  
**PC-31.167**





MAYO LEXER

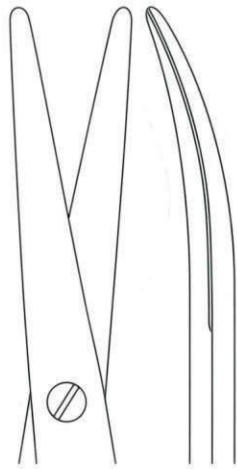

16.5 cm / 6½"  
 supercut **PC-32.187**  
 TCPC-32.97  
 supercut plus **PC-32.197**



LEXER

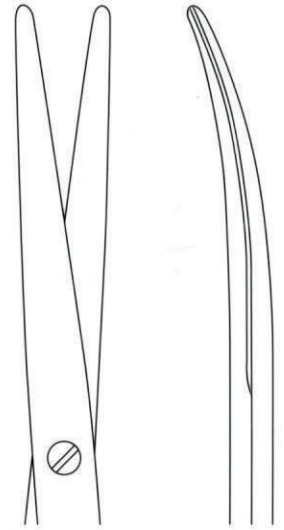

16 cm / 6¼"      16 cm / 6¼"  
 standard **PC-32.86**      **PC-32.17**  
 supercut **PC-32.116**      **PC-32.117**  
 TCPC-34.96      **PC-35.96**  
 supercut plus **PC-34.196**      **PC-35.196**



BABY METZENBAUM

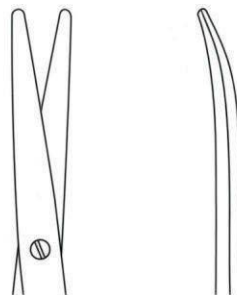

11.5 cm / 4½"      11.5 cm / 4½"  
 standard **PC-36.11**      **PC-37.11**  
 supercut **PC-36.111**      **PC-37.111**  
 TCPC-36.61      **PC-37.61**  
 supercut plus **PC-36.161**      **PC-37.161**

## Delicate Dissecting Scissors

Ножницы хирургические диссекционные РНФ

# Professional



METZENBAUM

standard **PC-36.14**  
 supercut **PC-36.114**  
 TC  
 supercut plus **PC-36.164**



14 cm / 5 1/2"

**PC-36.64**  
**PC-38.168**



18 cm / 7 1/8"

**PC-38.18**  
**PC-38.118**  
**PC-38.68**



20 cm / 8"

**PC-38.20**  
**PC-38.120**  
**PC-38.70**  
**PC-38.170**



BABY METZENBAUM

standard **PC-37.14**  
 supercut **PC-37.114**  
 TC **PC-37.64**  
 supercut plus **PC-37.164**

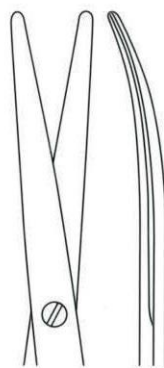

14 cm / 5 1/2"

**PC-39.168**

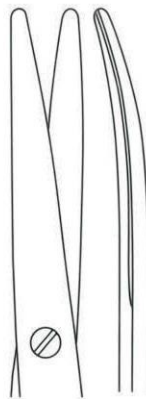

15 cm / 6"

**PC-37.15**  
**PC-37.115**  
**PC-39.68**

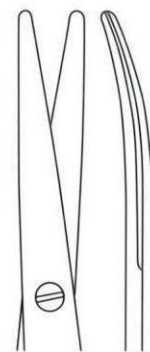

18 cm / 7 1/8"

**PC-39.18**  
**PC-39.118**  
**PC-39.70**  
**PC-39.170**

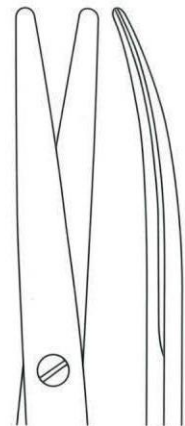

20 cm / 8"

**PC-39.20**  
**PC-39.120**



MINI METZENBAUM



9 cm / 3½"  
supercut **PC-36.109**



9 cm / 3½"  
**PC-37.109**



NELSON METZENBAUM



23 cm / 9"

standard **PC-40.23**  
supercut **PC-40.123**  
TC **PC-40.73**  
supercut plus **PC-40.173**



26 cm / 10¼"  
**PC-40.26**  
**PC-40.126**

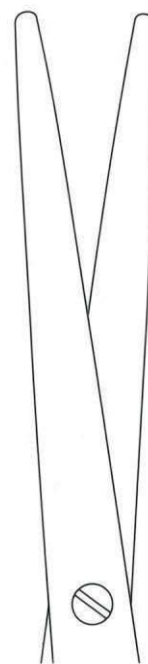

30 cm / 11¾"  
**PC-40.30**  
**PC-40.130**

## Delicate Dissecting Scissors

Ножницы хирургические диссекционные РНГ

# Professional

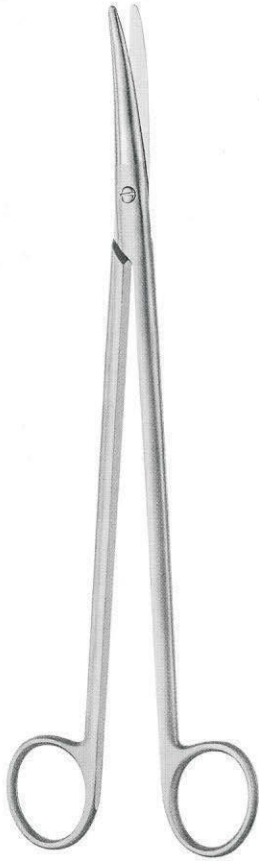

NELSON METZENBAUM

standard **PC-41.23**  
 supercut **PC-41.123**  
 TC **PC-41.73**  
 supercut plus **PC-41.173**

23 cm / 9"



26 cm / 10 1/4"  
**PC-41.26**  
**PC-41.126**  
**PC-41.76**  
**PC-41.176**



30 cm / 11 3/4"  
**PC-41.30**  
**PC-41.130**  
**PC-41.80**  
**PC-41.180**



METZENBAUM slim

standard **PC-42.14**  
 supercut **PC-42.114**  
 TC **PC-42.64**  
 supercut plus **PC-42.164**

14 cm / 5 1/2"

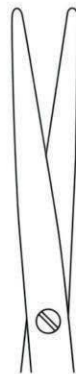

18 cm / 7 1/8"  
**PC-44.18**  
**PC-44.118**  
**PC-44.68**  
**PC-44.168**



20 cm / 8"  
**PC-44.20**  
**PC-44.120**  
**PC-44.70**  
**PC-44.170**



23 cm / 9"  
**PC-44.23**  
**PC-44.123**  
**PC-44.73**  
**PC-44.173**





METZENBAUM slim

standardPC-43.14  
 supercutPC-43.114  
 TCPC-43.64  
 supercut plusPC-43.164



14 cm / 5 1/2"



18 cm / 7 1/8"  
 PC-45.18  
 PC-45.118  
 PC-45.68

PC-45.168



20 cm / 8"  
 PC-45.20  
 PC-45.120  
 PC-45.70  
 PC-45.170

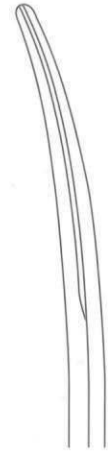

23 cm / 9"  
 PC-45.23  
 PC-45.123  
 PC-45.73  
 PC-45.173



METZENBAUM slim

28.5 cm / 11 1/4"  
 supercutPC-45.176

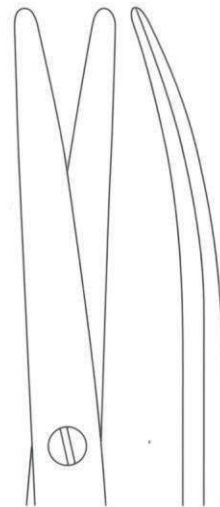
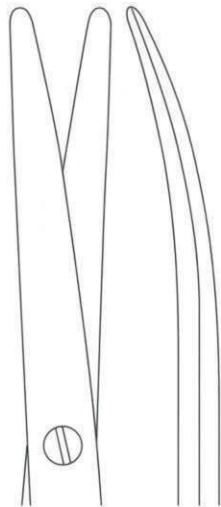

28.5 cm / 11 1/4"  
 PC-45.178



TOENNIS ADSON

18 cm / 7 1/8"  
 standardPC-50.18  
 supercutPC-50.118  
 TCPC-50.68  
 suercut plusPC-50.168

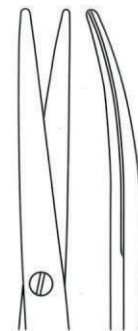



## Delicate Dissecting Scissors

Ножницы хирургические диссекционные РНГ

# Professional



METZENBAUM

supercutPC-46.168  
TCPC-46.78  
supercut plusPC-46.178

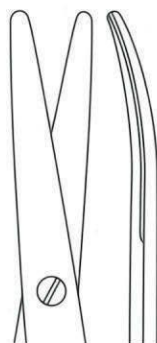

18 cm / 7 1/8"

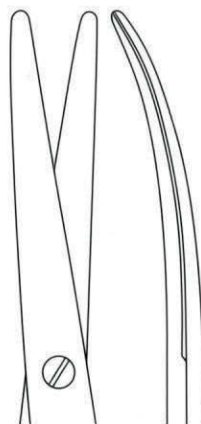

20 cm / 8"  
PC-46.170  
PC-46.80  
PC-46.180

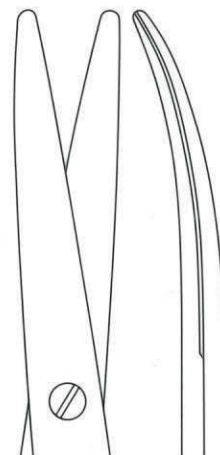

23 cm / 9"  
PC-46.173  
PC-46.83  
PC-46.183



METZENBAUM FREEMAN

18 cm / 7 1/8"  
supercutPC-47.168

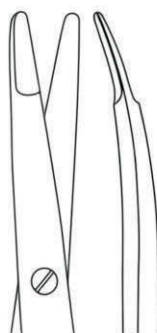

18 cm / 7 1/8"

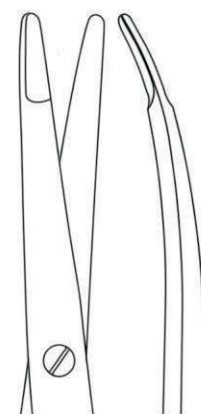

20 cm / 8"  
PC-47.170

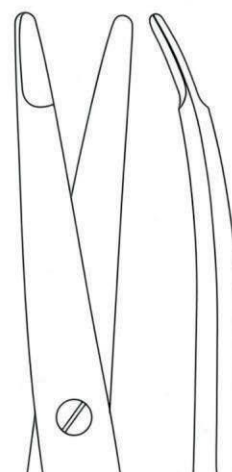

23 cm / 9"  
PC-47.173



KELLY

standard **PC-46.16**  
 supercut **PC-46.116**  
 TCPC-46.66  
 supercut plus **PC-46.166**

16 cm / 6 1/4"

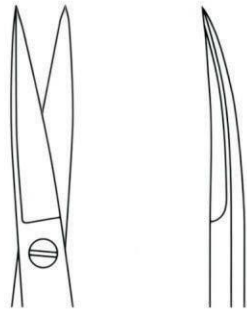

16 cm / 6 1/4"  
**PC-47.16**  
**PC-47.116**  
**PC-47.66**

**PC-47.166**



BRUSER KELLY

16 cm / 6 1/4"  
 supercut **PC-48.116**



16 cm / 6 1/4"  
**PC-49.116**



SIEBERT

11.5cm / 4 1/2"  
 standard **PC-58.131**  
 TCPC-58.61

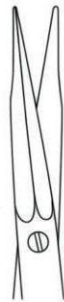

11.5cm / 4 1/2"

**PC-58.132**  
**PC-58.62**



RAGNELL (KILNER)

13 cm / 5 1/8"  
 standard **PC-59.13**  
 supercut **PC-59.113**  
 TCPC-59.63  
 supercut plus **PC-59.163**

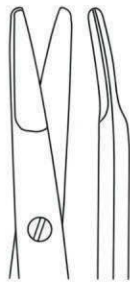

15 cm / 6"  
**PC-59.15**  
**PC-59.115**  
**PC-59.65**  
**PC-59.165**

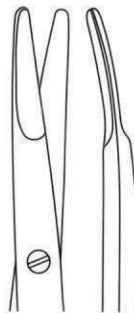

18 cm / 7 1/8"  
**PC-59.18**  
**PC-59.118**  
**PC-59.68**  
**PC-59.168**

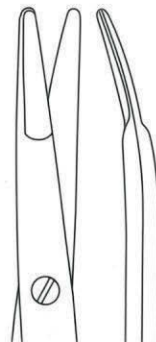

20 cm / 8"  
**PC-59.20**

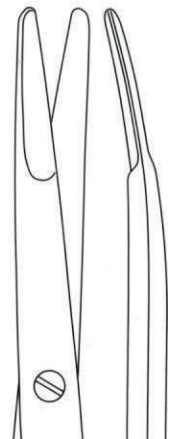

## Delicate Dissecting Scissors

Ножницы хирургические диссекционные РНГ

# Professional



GREENBERG PAR

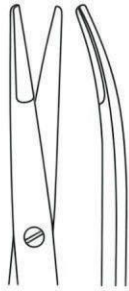

11.5 cm / 4 1/2"

supercut **PC-60.122**  
supercut plus **PC-61.122**



11 cm / 4 3/8"  
standard **PC-64.11**  
supercut **PC-64.111**



11 cm / 4 3/8"  
**PC-64.12**  
**PC-64.112**



JABELEY



13 cm / 5 1/8"  
standard **PC-64.13**  
supercut **PC-64.113**



13 cm / 5 1/8"  
**PC-64.14**  
**PC-64.114**



JOSEPH



15 cm / 6"  
standard **PC-65.14**  
supercut **PC-65.114**



15 cm / 6"  
**PC-66.14**  
**PC-66.114**



PECK JOSEPH

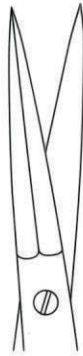

14 cm / 5½"  
supercut **PC-65.134**



14 cm / 5½"  
**PC-66.134**

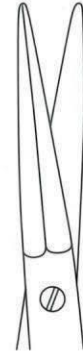

14 cm / 5½"  
**PC-65.144**



14 cm / 5½"  
**PC-66.144**



"slim"



14 cm / 5½"  
standard **PC-67.14**  
supercut **PC-67.114**  
TC **PC-67.64**  
supercut plus **PC-67.164**



18 cm / 7 1/8"  
**PC-67.18**

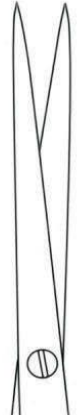

20 cm / 8"  
**PC-67.20**



"slim"



14 cm / 5½"  
standard **PC-68.14**  
supercut **PC-68.114**  
TC **PC-68.64**  
supercut plus **PC-68.164**



18 cm / 7 1/8"  
**PC-68.18**  
**PC-68.118**



20 cm / 8"  
**PC-68.20**

**Delicate Dissecting Scissors**

Ножницы хирургические диссекционные PHF

**Professional**



JAMESON



15cm / 6"  
supercut **PC-69.117**



18 cm / 7 1/8"  
**PC-70.118**



REYNOLDS (JAMESON)



12 cm / 4 3/4"  
standard **PC-72.12**  
blunt



14 cm / 5 1/2"  
**PC-72.14**  
blunt



16 cm / 6 1/4"  
**PC-72.16**  
blunt



18 cm / 7 1/8"  
**PC-72.18**  
blunt



REYNOLDS (JAMESON)



12 cm / 4 3/4"  
standard **PC-73.12**  
supercut **PC-73.112**  
blunt



14 cm / 5 1/2"  
**PC-73.14**



16 cm / 6 1/4"  
**PC-73.16**  
**PC-73.116**  
blunt



18 cm / 7 1/8"  
**PC-73.18**  
**PC-73.118**  
blunt





FANOUS

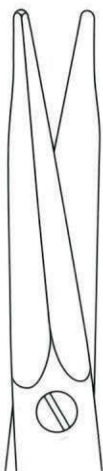

16.5 cm / 6½"  
supercutPC-74.116

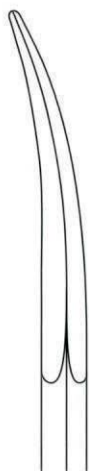

16.5 cm / 6½"  
PC-74.126

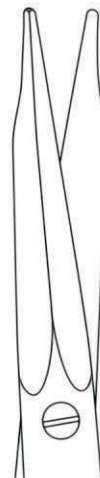

16.5 cm / 6½"  
PC-74.120



16.5 cm / 6½"  
PC-74.130



GORNEY

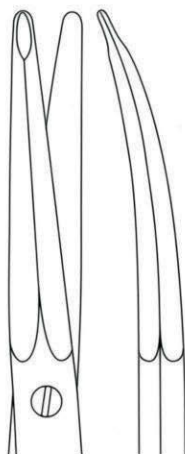

GORNEY  
supercutPC-77.127  
TCPC-77.67

17cm / 6¾"

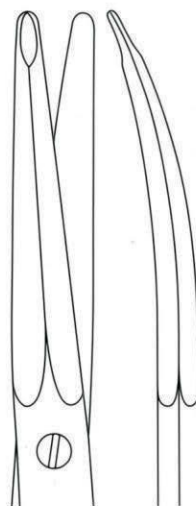

19 cm / 7½"  
PC-77.129  
PC-77.69

19 cm / 7½"  
PC-80.119  
PC-80.39

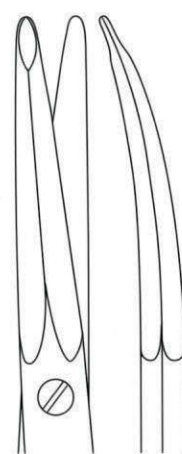

23 cm / 9"  
PC-77.133  
PC-77.73

23 cm / 9"  
PC-80.123  
PC-80.43

GORNEY-FREEMAN

supercutPC-80.117  
TCPC-80.37

17cm / 6¾"

19 cm / 7½"  
PC-80.119  
PC-80.39

23 cm / 9"  
PC-80.123  
PC-80.43

## Delicate Dissecting Scissors

Ножницы хирургические диссекционные РНГ

# Professional

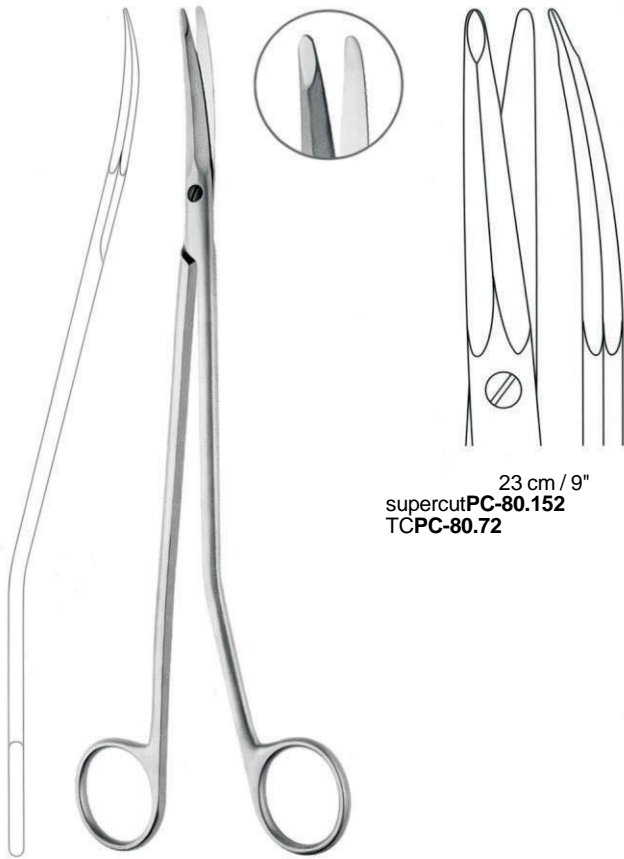

23 cm / 9"  
supercut **PC-80.152**  
TCPC-80.72

GORNEY-FREEMAN



12 cm / 4¾"  
standard **PC-80.01**

GORNEY-FREEMAN

Ножницы атомические LITTLER с г/зками для швного материала, иогнутые по плоскости, тупоконечные, 12 см



KAYE Ножницы для фейслифтинга

15 cm / 6"  
supercut **PC-81.115**  
TC

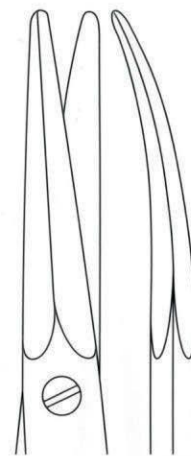

17 cm / 6¾"  
**PC-81.117**  
**PC-81.37**



19 cm / 7½"  
supercutPC-81.119  
TCPC-81.39

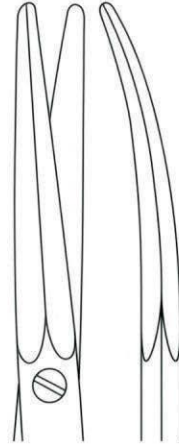
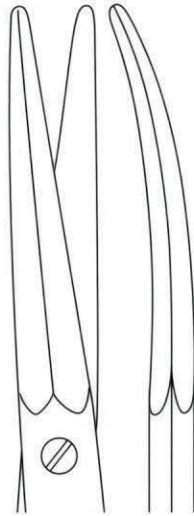

23 cm / 9"  
PC-81.123  
PC-81.43



11.5 cm / 4½"  
supercutPC-81.132

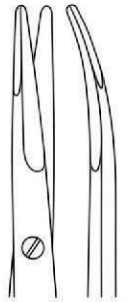

KAYE Ножницы для фейслифтинга

KAYE Ножницы для фейслифтинга



20 cm / 8"  
supercutPC-83.220

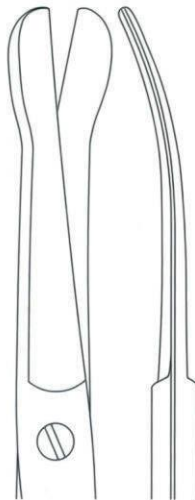

20 cm / 8"  
supercutPC-83.230

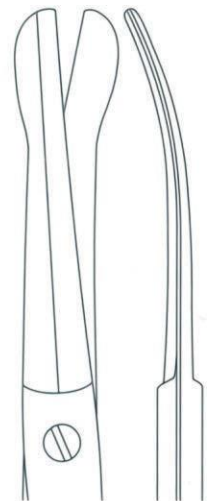

SOLZ Ножницы для фейслифтинга

SOLZ Ножницы для фейслифтинга

# Stitch Scissors

Шовные ножницы

# Professional



FOX

Ножницы для снятия швов  
FOX, одно лезвие зазубрено

standard **PC-90.13**  
supercut **PC-90.113**  
TC **PC-90.63**  
supercut plus **PC-90.163**

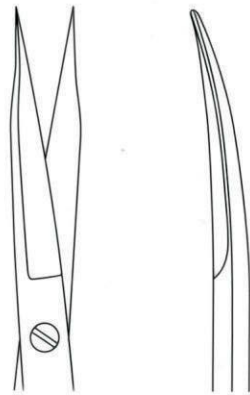

13 cm / 5 1/8"

13 cm / 5 1/8"  
**PC-91.13**  
**PC-91.113**  
**PC-91.63**  
**PC-91.163**



SPENCER

Ножницы лигатурные SPENCER



9 cm / 3 1/2"  
standard **PS-19.09**  
TC



10.5 cm / 4 1/8"  
**PS-20.10**  
**PS-20.60**

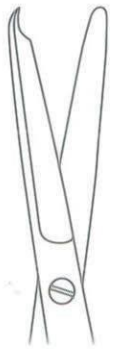

12 cm / 4 3/4"  
**PS-20.12**  
**PS-20.62**



LITTAUER Ножницы шовные

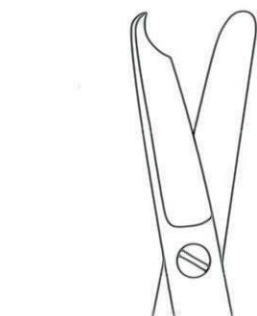

13 cm / 5 1/8"  
standard **PS-21.13**



KELLY Ножницы шовные



15 cm / 6"  
standard **PS-21.35**



O'BRIEN Шовные ножницы

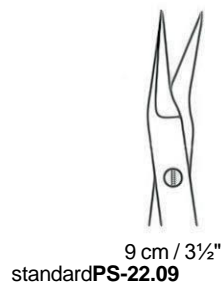

9 cm / 3½"  
standard PS-22.09

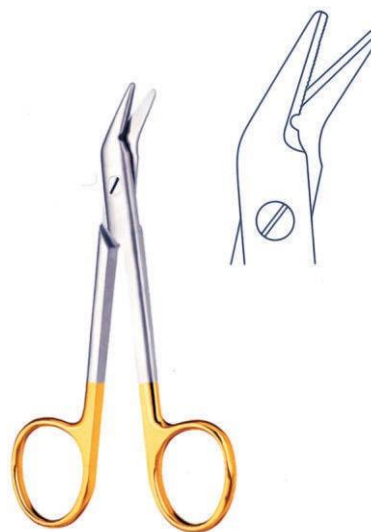

Лигатурные ножницы UNIVERSAL  
PS-24.12  
12 cm / 4¾"



Лигатурные ножницы

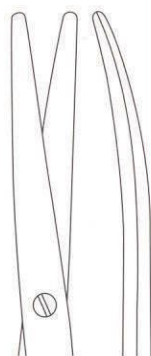

TCPS-36.84

14.5cm / 5¾"

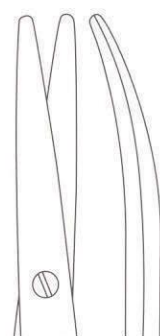

PS-36.88

18 cm / 7¼"

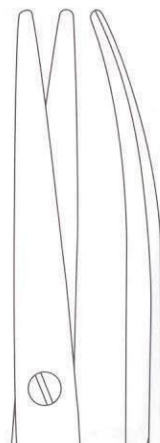

PS-36.93

23 cm / 9"





DEAN

Ножницы для ринопластики DEAN, одно лезвие зазубрено

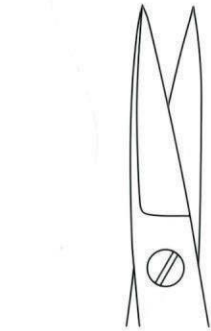

17 cm / 6 3/4"  
standard PAK-25.17  
supercut PAK-25.117



HEYMANN Назальные ножницы



20 cm / 8"  
standard PAM-17.20



HEYMANN Назальные ножницы

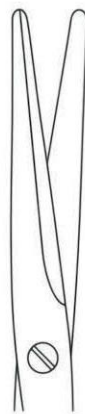

17 cm / 6 3/4"  
standard PAM-17.17  
supercut

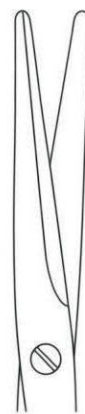

17 cm / 6 3/4"  
PAM-17.21

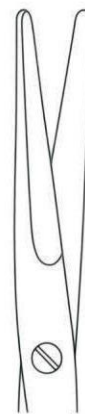

18 cm / 7 1/8"  
PAM-17.122

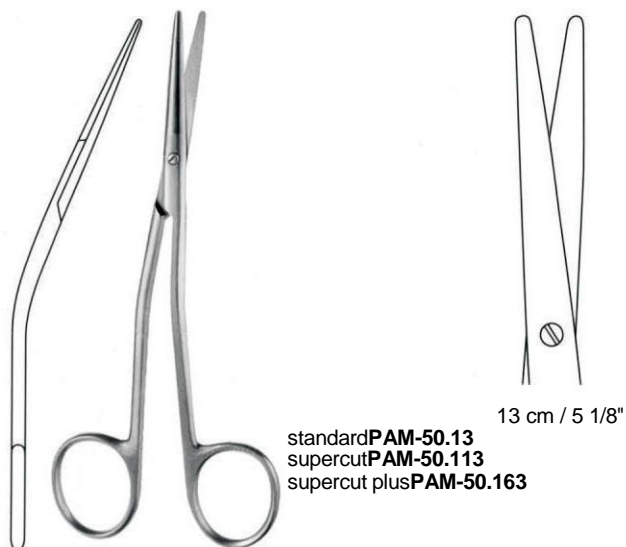

standard **PAM-50.13**  
supercut **PAM-50.113**  
supercut plus **PAM-50.163**

FOMON **Назальные ножницы**



14 cm / 5 1/2"  
supercut **PAM-50.14**

WALTER **Ножницы для ринопластики**



supercut **PAM-50.16**  
TC **PAM-50.77**  
supercut plus **PAM-50.177**

WALTER COTTLE **Назальные ножницы**

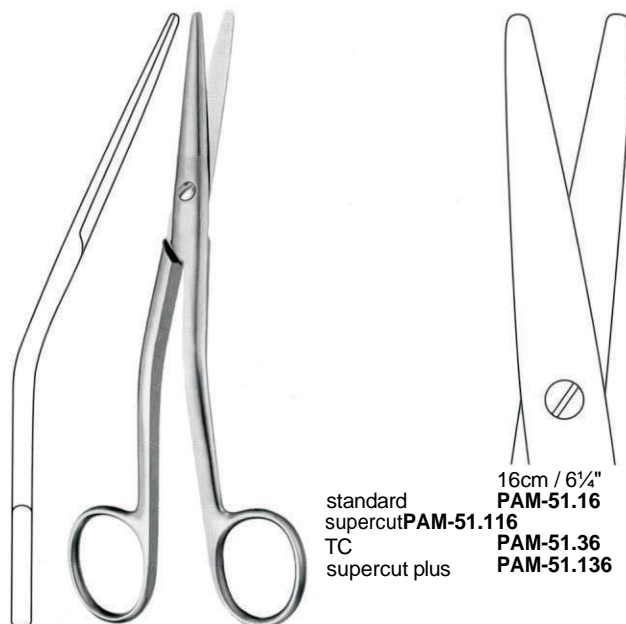

16 cm / 6 1/4"  
standard **PAM-51.16**  
supercut **PAM-51.116**  
TC **PAM-51.36**  
supercut plus **PAM-51.136**

COTTLE **Ножницы дорсальные**

# Rhinoplasty Scissors

Ножницы для ринопластики

# Professional



13.5 cm / 5 3/8"  
TCPAM-51.63

GIUNTA Назальные ножницы



13.5 cm / 5 3/8"  
standardPAN-43.13

CONVERSE Назальные ножницы

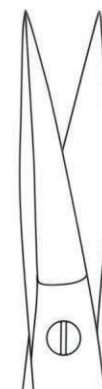

10 cm / 4"  
standardPAN-46.10

COTTLE MASING Ножницы для ринопластики

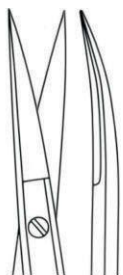

10 cm / 4"  
PAN-47.10



11.5 cm / 4 3/4"  
standardPAN-49.12

COTTLE Ножницы назальные COTTLE Bulldog

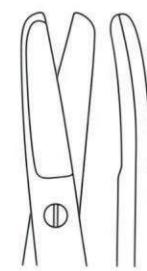

11 cm / 4 3/8"  
standardPAN-51.11

CINELLI Ножницы назальные,  
внешняя сторона лезвий  
полуострая

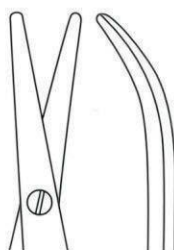

12.5 cm / 5"  
standardPAN-51.43

FOMON Ножницы назальные FOMON Saber Back  
с обоюдоострыми режущими кромками

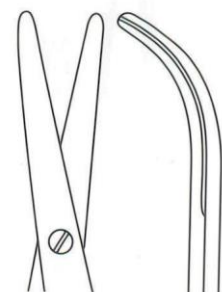

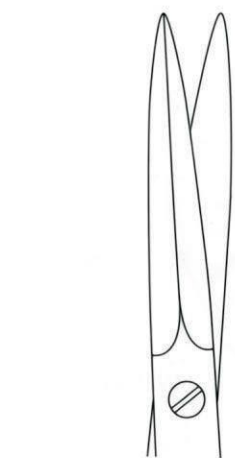

19 cm / 7½"  
standard **PAN-51.18**

MCINDOE Ножницы для ринопластики

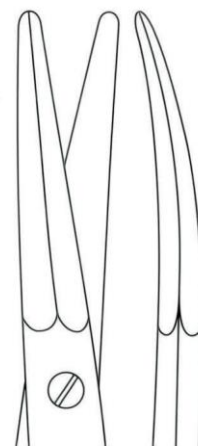

14 cm / 5½"  
standard **PAN-51.34**  
supercut **PAN-51.134**  
TCPAN-51.64  
supercut plus **PAN-51.164**

AUFRICHT  
Ножницы для ринопластики

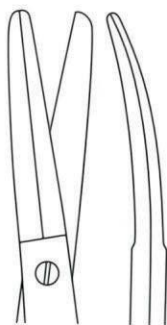

12.5 cm / 5"  
standard **PAN-51.43**

FOMON

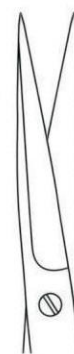

13 cm / 5 1/8"  
standard **PAN-52.14**  
supercut **PAN-52.114**

FANOUS Ножницы для ринопластики

# Rhinoplasty Scissors

Ножницы для ринопластики

# Professional

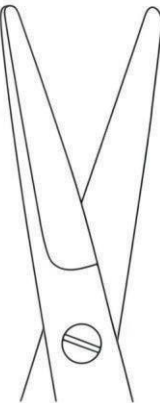

Ножницы назальные пружинистые

COTTLE  
PAN-54.19  
18 cm / 7 1/8"



Ножницы назальные пружинистые

CAPLAN  
PAN-55.20  
20 cm / 8"

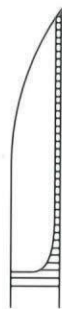

21cm / 8 1/4"  
PAN-56.31

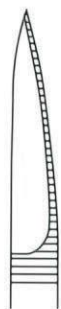

21cm / 8 1/4"  
PAN-56.32

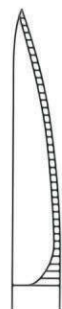

21cm / 8 1/4"  
PAN-56.33

OBWEGESER Ножницы назальные пружинистые



micro 2000

с зазубренными режущими кромками

serrated cutting edges

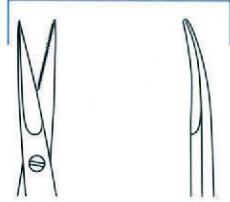

15 cm / 6"  
standard PD-01.22

15 cm / 6"  
PD-01.23

рабочая часть по VANNAS

Vannas-type cutting edges

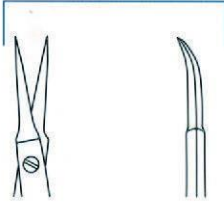

15 cm / 6"  
PD-01.30

15 cm / 6"  
PD-01.31



micro 2000



15 cm / 6"  
standard PD-01.20  
supercut PD-01.120



15 cm / 6"  
PD-01.21  
PD-01.121



15 cm / 6"  
standard PD-01.74  
supercut PD-01.174



15 cm / 6"  
PD-01.75

рабочая часть по VANNAS

Vannas-type cutting edges

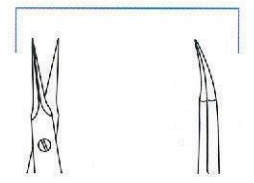

15 cm / 6"  
PD-01.76

15 cm / 6"  
PD-01.77

Бранши круглые

Round handle



18 cm / 7 1/4"  
standard PD-07.20



18 cm / 7 1/4"  
PD-07.21



18 cm / 7 1/4"  
PD-07.25



18 cm / 7 1/4"  
PD-07.26



23 cm / 9"  
standard PD-08.02

Бранши круглые

Round handle







PE-03.10  
Fig. 10



PE-03.11  
Fig. 11



PE-03.12  
Fig. 12



PE-03.32  
Fig. 12d



PE-03.15  
Fig. 15



PE-03.35  
Fig. 15c



PE-03.35  
Fig. 15c



PE-03.23  
Fig. 23



PE-04.03  
No.3  
12.5 cm / 5"



PE-05.07  
No.7  
16.5 cm / 6½"



PE-06.17  
No.7K  
12 cm / 4¾"



PE-07.13  
No.3L  
21 cm / 8¼"



PE-08.23  
No.3LA  
20.5 cm / 8"



PE-10.40  
15.5 cm / 6 1/8"





PE-10.45  
22.5 cm / 9"



PE-10.53  
27 cm / 10<sup>3</sup>/<sub>4</sub>"



PE-10.61  
21 cm / 8<sup>1</sup>/<sub>4</sub>"

Ручка для скальпеля Blake



PE-10.63  
15.5 cm / 6 1/8"



PE-10.64  
21 cm / 8<sup>1</sup>/<sub>4</sub>"



**PE-10.92**  
Fig. 62



**PE-10.94**  
Fig. 64



**PE-10.95**  
Fig. 65



**PE-10.97**  
Fig. 67



**LANDOLT**  
**PE-10.86**  
21 cm / 8 1/4"



**LANDOLT**  
**PE-10.87**  
25 cm / 10"



**PE-10.90** 13 cm / 5 1/8"  
**PE-10.91** 15.5 cm / 6 1/8"

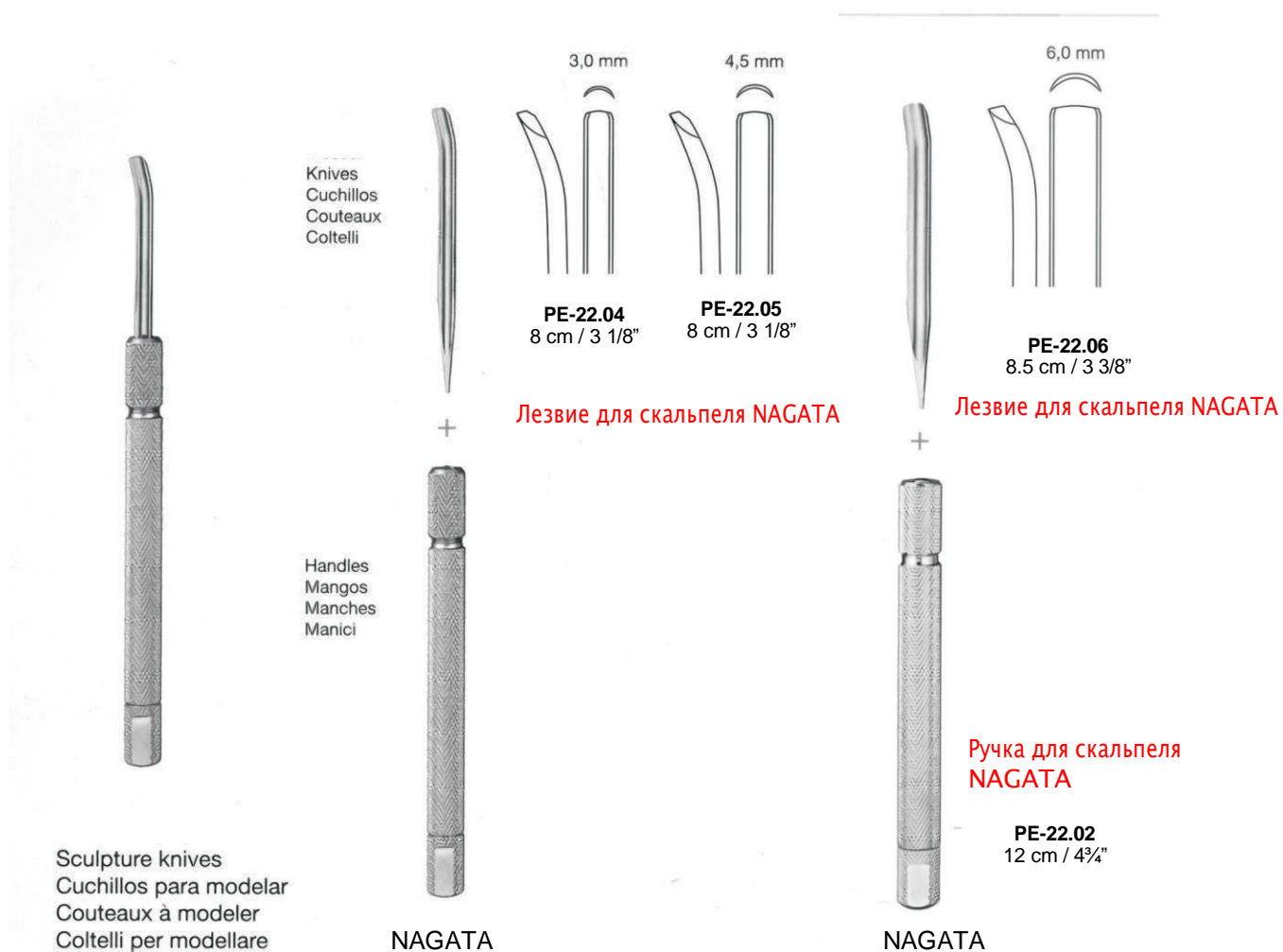



**HUMBLY**  
**PE-30.30**  
32 cm / 5½"

Дерматом ручной  
HUMBLY,  
регулируемый 0.1  
до 1.2 мм, 155 мм



**PE-30.31**  
15.5 cm / 6 1/8"

Сменное  
лезвие для  
дерматомов  
HUMBLY и  
WATSON,  
15.5 см



**WATSON**  
**PE-30.32**  
30.5 cm / 12"

Дерматом  
ручной  
WATSON,  
регулируем  
ый 0.1 to 2.0  
мм, 15.5 см



**SCHINK**  
**PE-30.50**  
30 cm / 11¾"

Дерматом ручной  
SCHINK,  
регулируемый от  
0.1 to 2.0 мм, 100  
мм



**PE-30.51**  
10 cm / 4"

Сменное лезвие  
для дерматом  
SCHINK, 10 см



**PE-30.52**  
13 x 7.5 cm

Пластина для  
фиксации  
кожного  
лоскута для  
дерматом  
SCHINK,  
13x7.5 см



**SILVER**  
**PE-30.60**  
19 cm / 7½"

Скальпель для взятия  
кожного  
трансплантата  
(дерматом) Silver,  
19cm (7 1/2"),  
регулируемый от 0.1 to  
2.0 мм, 19 см



**PF-07.14**  
14.5 cm / 5¾"



**ADSON PF-15.12**  
12 cm / 4¾"



**ADSON PF-15.62**  
12 cm / 4¾"



**ADSON PF-15.65**  
12.5 cm / 6"



**HUDSON-EWALD PF-16.01**  
12 cm / 4¾"



**HUDSON-EWALD PF-16.05**  
12 cm / 4¾"



**ADSON**



**PF-16.12**  
12 cm / 4¾"



**PF-16.13**  
12 cm / 4¾"



**ADSON PF-16.15**  
15 cm / 6"



ADSON  
PF-16.62  
12 cm / 4¾"



ADSON  
PF-16.65  
15 cm / 6"



MICRO ADSON



PF-17.12  
12 cm / 4¾"



PF-19.12  
12 cm / 4¾"



MICRO ADSON



PF-18.15  
15 cm / 6"



PF-20.15  
15 cm / 6"



ADSON BROWN  
12 cm / 4¾"



7 x 7  
PF-21.12



9 x 9  
PF-21.13



ADSON BROWN  
 PF-22.72  
 12 cm / 4¾"



ADSON GRAEFE  
 PF-23.82  
 12 cm / 4¾"



SEMKEN



PF-30.12  
 12 cm / 4¾"



PF-31.22  
 12 cm / 4¾"



PF-30.15  
 15 cm / 6"



PF-31.25  
 15 cm / 6"



SEMKEN



PF-32.12  
 12 cm / 4¾"



PF-33.22  
 12 cm / 4¾"



PF-32.15  
 15 cm / 6"



PF-33.25  
 15 cm / 6"



SEMKEN  
 PF-34.32  
 12 cm / 4¾"



MCINDOE  
 PF-35.15  
 15 cm / 6"







GILLIES  
PF-36.85  
15 cm / 6"



WAUGH



PF-37.15  
15 cm / 6"



PF-38.15  
15 cm / 6"



WAUGH



PF-37.20  
20 cm / 8"



PF-38.20  
20 cm / 8"



PF-42.40  
20 cm / 8"



PF-60.15  
15 cm / 6"



PF-60.23  
23 cm / 9"



DEBAKEY  
PF-43.15  
15 cm / 6"



NELSON



WALTER  
PF-60.26  
16 cm / 6 1/4"



WALTER  
PF-60.36  
16 cm / 6 1/4"

Пинцет носовой  
штыковой  
GRUENWALD-  
JANSEN с насечкой,  
байонетный, 16 см



GRUENWALD  
PF-64.16  
16 cm / 6¼"

Пинцет ушной  
горизонтально-  
изогнутый  
TROELTSCH  
(WILDE), с  
насечками,  
взрослый, 13 см



TROELTSCH (WILDE)  
PF-70.13  
13 cm / 5"

**Suturing Forceps**  
Pinzas para sutura  
Pinces à suture  
Pinze per sutura

Пинцеты  
для  
наложения  
швов  
MICRO

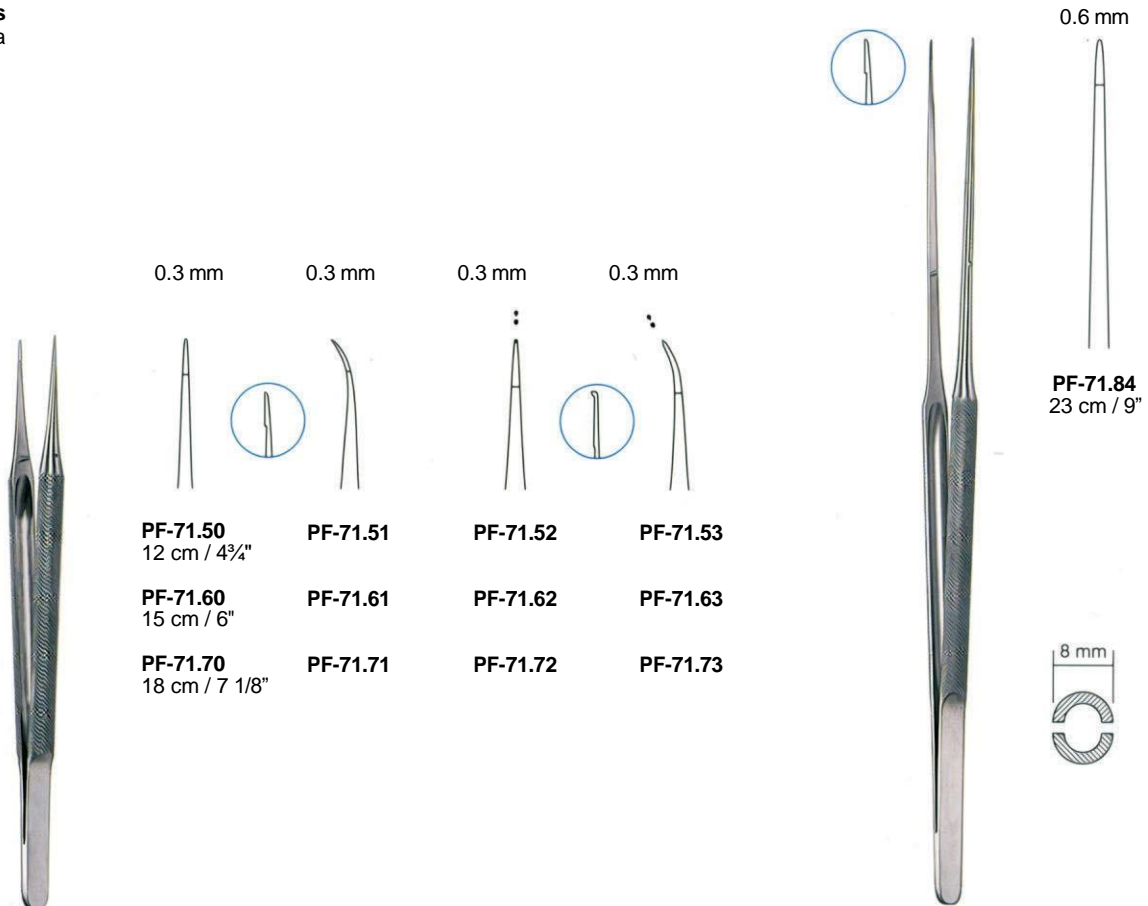

0.3 mm

0.3 mm

0.3 mm

0.3 mm

0.6 mm

PF-71.50  
12 cm / 4¾"

PF-71.51

PF-71.52

PF-71.53

PF-71.60  
15 cm / 6"

PF-71.61

PF-71.62

PF-71.63

PF-71.70  
18 cm / 7 1/8"

PF-71.71

PF-71.72

PF-71.73

PF-71.84  
23 cm / 9"

8 mm

Пинцет для фиксации век WALTER, 8 см



WALTER  
PAB-57.18  
8 cm / 3 1/8"



COTTLE  
PAN-60.15  
15 cm / 6"



FOX



PAN-62.13  
13 cm / 5 1/8"



PAN-62.15  
15 cm / 6"



FOX  
PAN-64.15  
15 cm / 6"

Корнцанг  
FOX,  
изогнутый,  
15.5 см

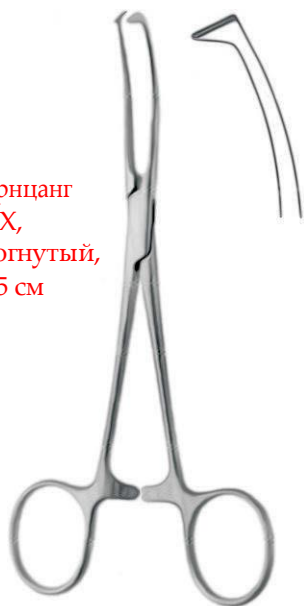

FOX  
PAN-65.15  
15.5 cm / 6 1/8"

Пинцет  
назальный по  
COTTLE,  
окончатый, с  
фиксирующим  
винтом,  
рифленый, 15 см



COTTLE  
PAN-66.15  
15 cm / 6"

Зажим сосудистый  
DIETHRICH BULLDOG, с  
атравматической насечкой  
прямой



DIETHRICH

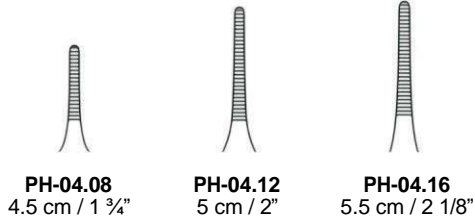

Зажим сосудистый  
DIETHRICH BULLDOG, с  
атравматической насечкой  
изогнутый



DIETHRICH

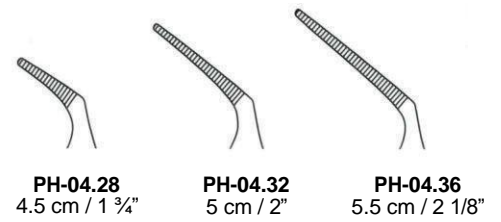

MOSQUITO

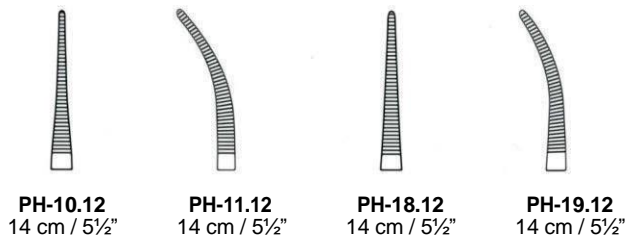

MOSQUITO

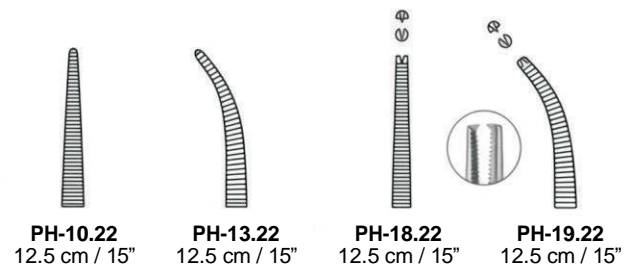

Зажим кровоостанавливающий  
HALSTED MOSQUITO, с  
атравматической насечкой



Зажим кровоостанавливающий AT Mosquito, с атравматической насечкой

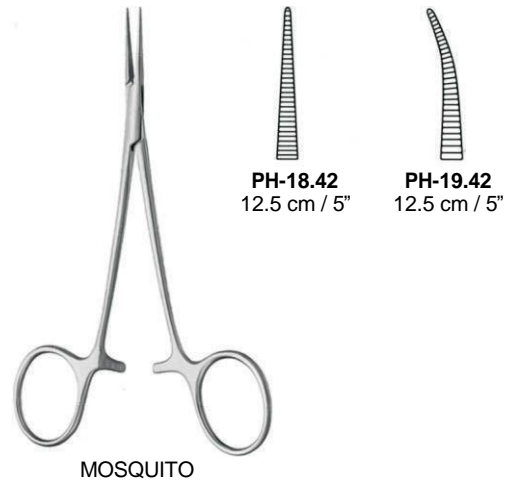
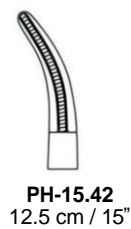

Зажим кровоостанавливающий JACOBSON Micro Mosquito, с атравматической насечкой, очень тонкие рабочие поверхности

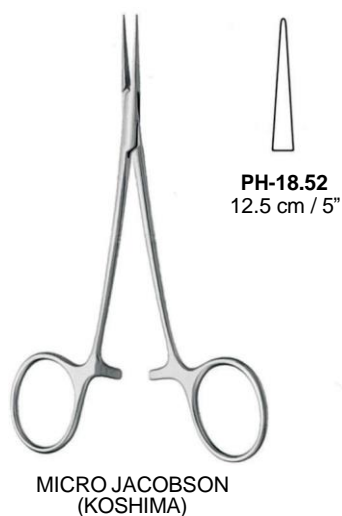

Ультратонкий артериальный зажим Micro JACOBSON KOSHIMA

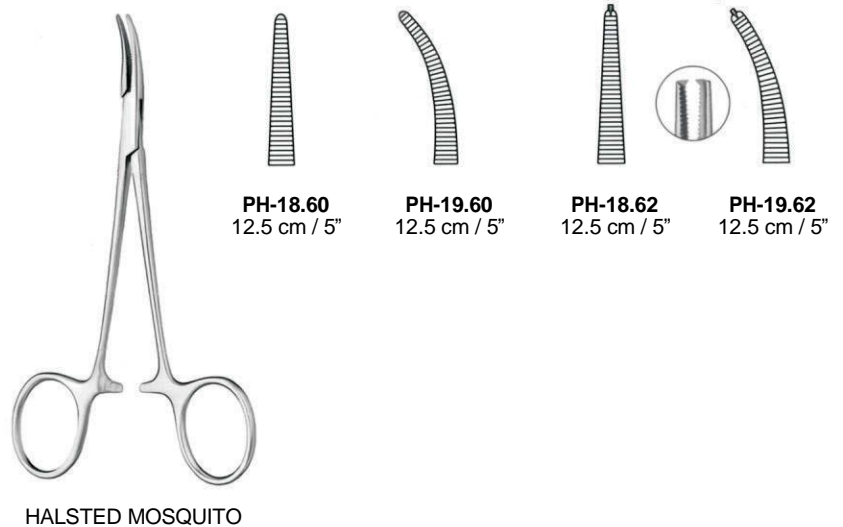

Ультратонкий артериальный зажим HALSTED MOSQUITO, с атравматической насечкой

PH-18.60  
12.5 cm / 5"

PH-19.60  
12.5 cm / 5"

PH-18.62  
12.5 cm / 5"

PH-19.62  
12.5 cm / 5"

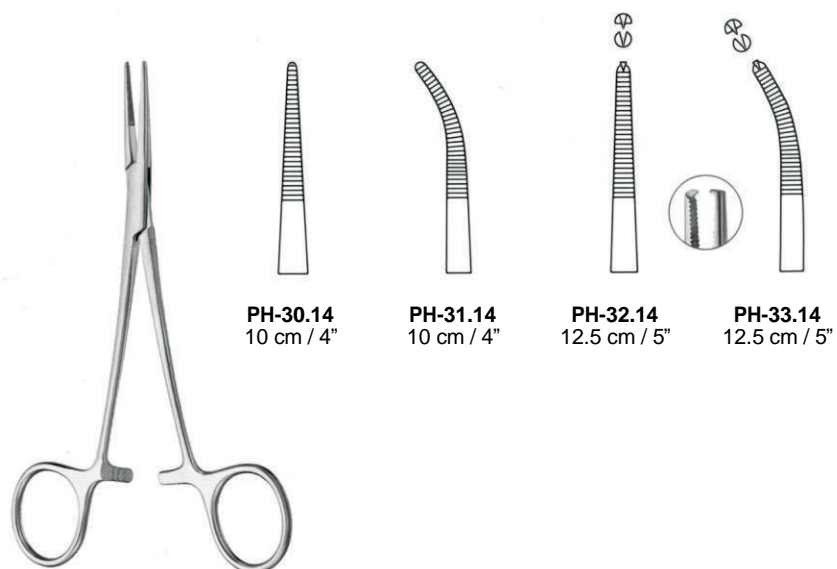

PH-30.14  
10 cm / 4"

PH-31.14  
10 cm / 4"

PH-32.14  
12.5 cm / 5"

PH-33.14  
12.5 cm / 5"

PROVIDENCE HOSPITAL  
Зажим гемостатический

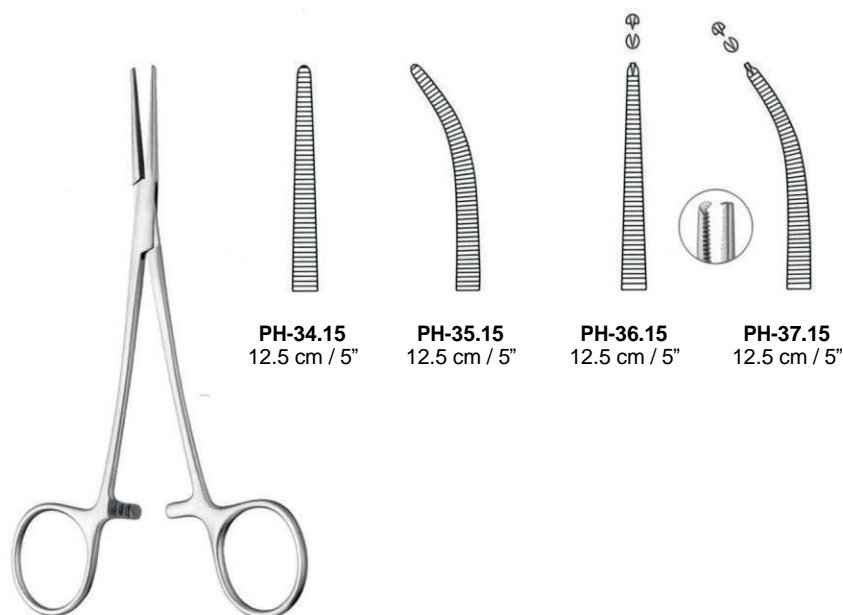

PH-34.15  
12.5 cm / 5"

PH-35.15  
12.5 cm / 5"

PH-36.15  
12.5 cm / 5"

PH-37.15  
12.5 cm / 5"

LERICHE  
Зажим гемостатический



COLLIER  
PJ-05.13  
13 cm / 5 1/8"

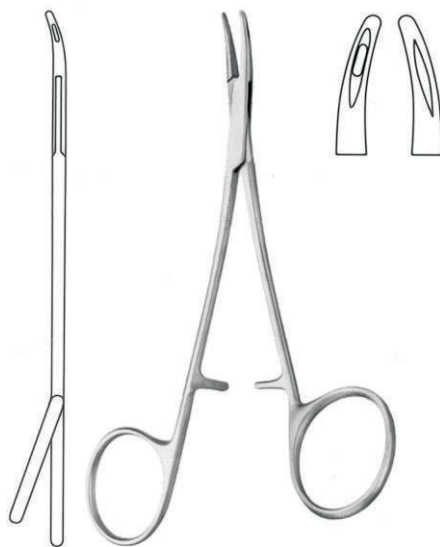

CONVERSE  
PJ-06.15  
15 cm / 6"

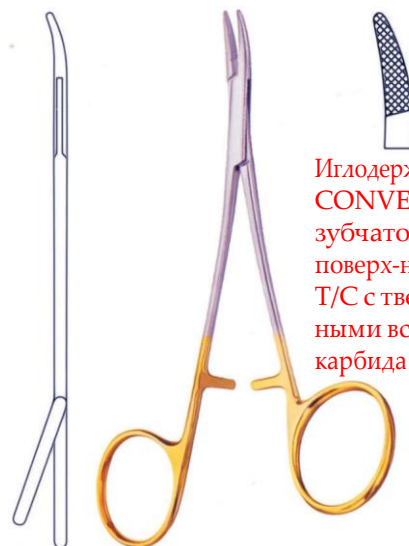

CONVERSE  
PJ-07.65  
15 cm / 6"

Иглодержатель CONVERSE с зубчатой рабочей поверхностью, тип Т/С с твердосплавными вставками из карбида вольфрама,



NAGATA

Иглодержатель NAGATA, тип Т/С с твердосплавными вставками из карбида вольфрама

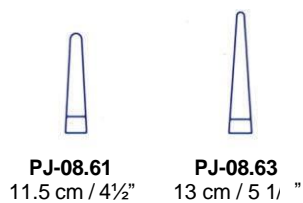

PJ-08.61  
11.5 cm / 4 1/2"

PJ-08.63  
13 cm / 5 1/4"

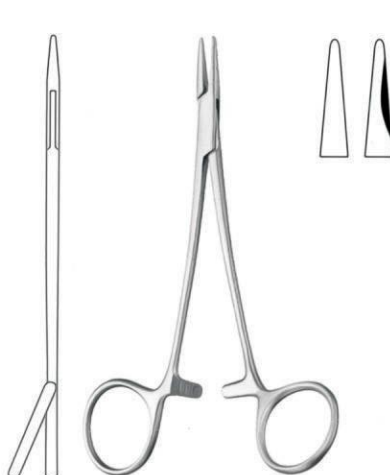

NEIVERT  
PJ-09.12  
12.5 cm / 5"



NEIVERT  
PJ-10.62  
12.5 cm / 5"

Иглодержатель NEIVERT, тип Т/С с твердосплавными вставками из карбида вольфрама



Иглодержатель GUBISCH с  
гладкой рабочей  
поверхностью, тип Т/С с  
твердосплавными вставками из  
карбида вольфрама



GUBISCH  
PJ-13.61  
12.5 cm / 5"

Иглодержатель WRIGHT (DERF) с  
зубчатой рабочей поверхностью,  
тип Т/С с твердосплавными  
вставками из карбида вольфрама



WRIGHT (DERF)  
PJ-13.62  
12.5 cm / 5"

Иглодержатель HALSEY с  
зубчатой рабочей  
поверхностью, тип Т/С с  
твердосплавными  
вставками из карбида  
вольфрама



HALSEY  
PJ-15.63  
13.5 cm / 5 3/8"



WRIGHT (DERF)  
PJ-12.12  
12.5 cm / 5"



HALSEY  
PJ-14.13  
13.5 cm / 5 3/8"



DERF CONVERSE  
PJ-17.82  
12.5 cm / 5"



CRILE WOOD



PJ-34.15  
15 cm / 6"



PJ-21.18  
18 cm / 7 1/8"



PJ-21.20  
20 cm / 8"



PJ-21.23  
23 cm / 9"

Иглодержатель CRILE WOOD с зазубренными браншами,  
тип Т/С с твердосплавными вставками из карбида  
вольфрама



CRILE WOOD



PJ-22.15  
15 cm / 6"



PJ-22.18  
18 cm / 7 1/8"



PJ-22.20  
20 cm / 8"



PJ-22.23  
23 cm / 9"



PJ-22.25  
25 cm / 10"



PJ-22.30  
30 cm / 11 1/4"



MAYO HEGAR

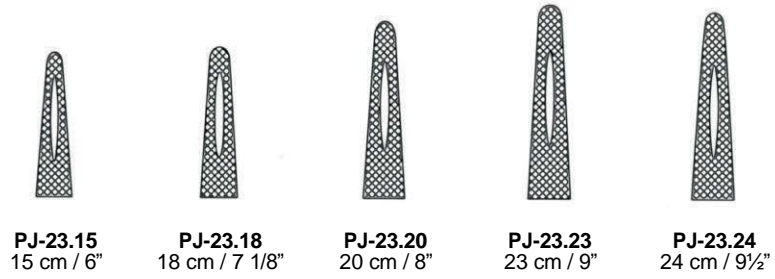

Иглодержатель MAYO HEGAR с зазубренными браншам, тип Т/С с твердосплавными вставками из карбида вольфрама



MAYO HEGAR

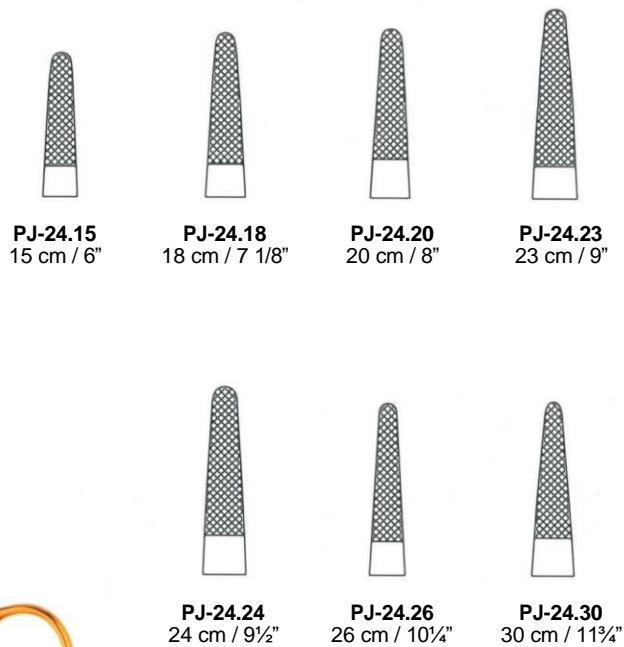

Иглодержатель SENNING тип Т/С с твердосплавными вставками из карбида вольфрама

с короткой гладкой рабочей частью

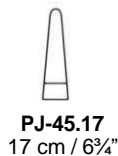

с короткой зазубренной рабочей частью

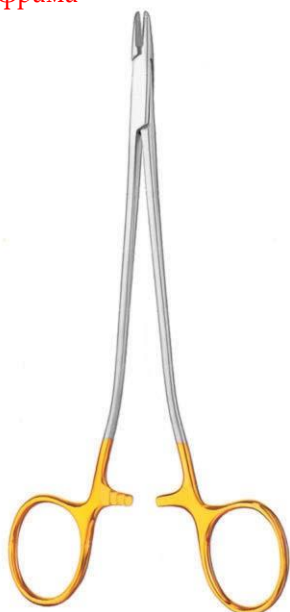

SENNING

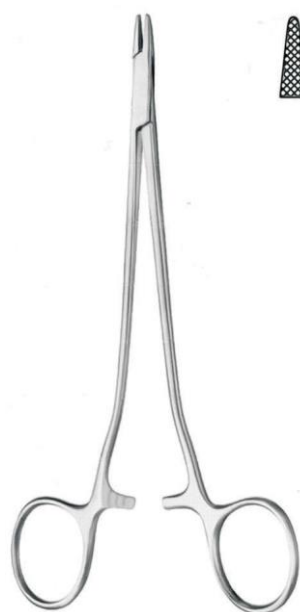

SENNING  
**PJ-46.17**  
17 cm / 6¾"

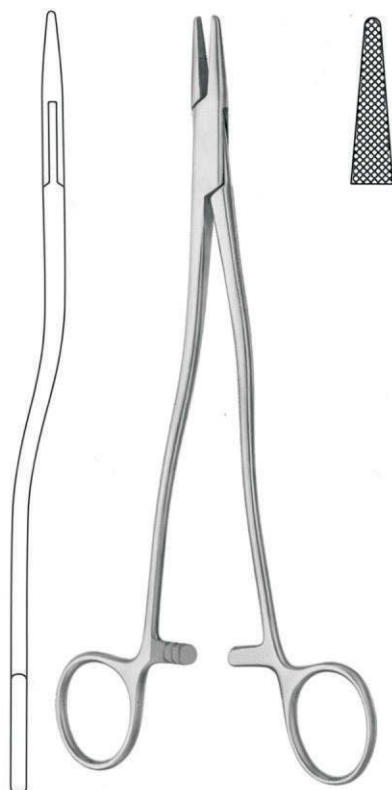

THOMSON WALKER  
(BOZEMANN)  
**PJ-47.20**  
20 cm / 8"

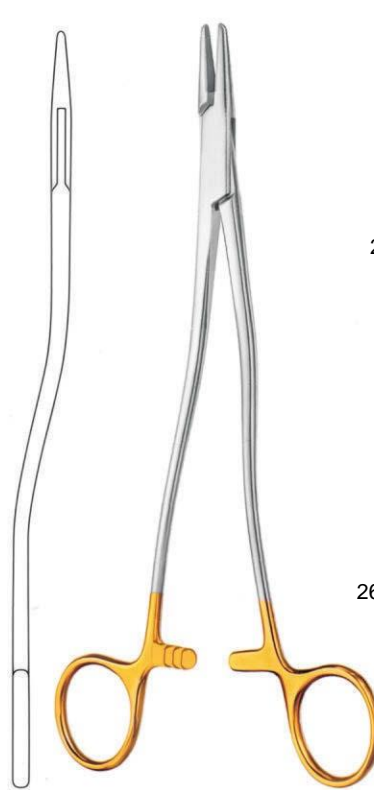

BOZEMANN  
(WERTHEIM)

Иглодержатель BOZEMANN WERTHEIM с зубчатой рабочей поверхностью, S-изогнутый по оси, тип Т/С с твердосплавными вставками из карбида вольфрама

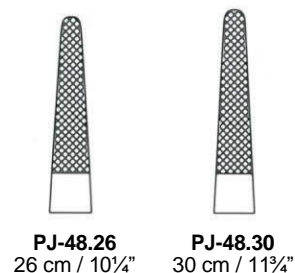
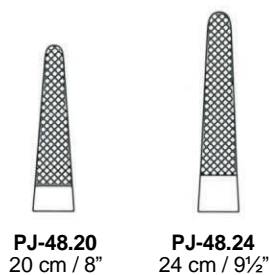

Иглодержатель-ножницы  
GILLIES SLIM



GILLIES SLIM  
PJ-53.14  
14.5 cm / 5¾"

Иглодержатель-ножницы GILLIES  
SLIM, тип Т/С с твердсплавными  
вставками из карбида вольфрама



GILLIES SLIM  
PJ-54.15  
14.5 cm / 5¾"



GILLIES  
PJ-55.15  
15.5 cm / 6 1/8"

Иглодержатель-ножницы OBWEGESER-GILLIES

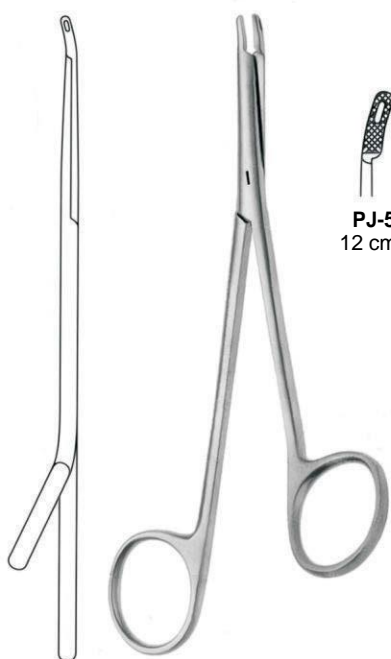

OBWEGESER GILLIES



PJ-55.31  
12 cm / 4¾"

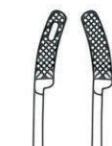

PJ-55.34  
14.5 cm / 5¾"

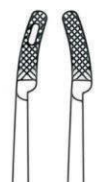

PJ-55.37  
17 cm / 6¾"



OBWEGESER GILLIES  
PJ-55.58  
16 cm / 6¼"

Иглодержатель-ножницы OBWEGESER-GILLIES  
усиленный

Иглодержатель-ножницы GILLIES SLIM, тип T/C с твердосплавными вставками из карбида вольфрама



GILLIES  
PJ-56.16  
15.5 cm / 6 1/8"

Иглодержатель MATHIEU с кремальерой и возвратной пружиной, тип T/C с твердосплавными вставками из карбида вольфрама



MATHIEU



PJ-69.14  
14 cm / 5 1/2"



PJ-69.17  
17 cm / 6 3/4"



PJ-69.20  
20 cm / 8"



PJ-69.24  
24 cm / 9 1/2"

Иглодержатель по COTTLE-MASING, в форме щипцов, интраназальный, с гладкими браншами



COTTLE MASING



PAN-30.56  
a = 60 mm













PAN-30.59  
a = 90 mm



smooth











**Иглодержатель микрохирургический сосудистый MICRO, рабочая часть гладкая либо с алмазным напылением**



				
a = 0.4 mm a = 0.4 mm	13 cm / 5 1/8" <b>PK-22.13</b>	15 cm / 6" <b>PK-21.15</b> <b>PK-22.15</b>	18 cm / 7 1/8" <b>PK-21.18</b> <b>PK-22.18</b>	21 cm / 9" <b>PK-21.21</b> <b>PK-22.21</b>
a = 0.5 mm a = 0.5 mm			<b>PK-21.38</b> <b>PK-22.38</b>	<b>PK-21.41</b> <b>PK-22.41</b>
				
a = 0.4 mm a = 0.4 mm	13 cm / 5 1/8" <b>PK-24.13</b>	15 cm / 6" <b>PK-23.15</b> <b>PK-24.15</b>	18 cm / 7 1/8" <b>PK-23.18</b> <b>PK-24.18</b>	21 cm / 9" <b>PK-23.21</b> <b>PK-24.21</b>
a = 0.5 mm a = 0.5 mm	<b>PK-24.33</b>		<b>PK-23.38</b> <b>PK-24.38</b>	<b>PK-23.41</b> <b>PK-24.41</b>

**Иглодержатель микрохирургический сосудистый MICRO с фиксатором, рабочая часть гладкая либо с алмазным напылением**



				
a = 0.4 mm a = 0.4 mm	13 cm / 5 1/8" <b>PK-32.13</b>	15 cm / 6" <b>PK-31.15</b> <b>PK-32.15</b>	18 cm / 7 1/8" <b>PK-31.18</b> <b>PK-32.18</b>	21 cm / 9" <b>PK-31.21</b> <b>PK-32.21</b>
a = 0.5 mm a = 0.5 mm			<b>PK-31.38</b> <b>PK-32.38</b>	<b>PK-31.41</b> <b>PK-32.41</b>
				
a = 0.4 mm a = 0.4 mm	13 cm / 5 1/8" <b>PK-34.13</b>	15 cm / 6" <b>PK-33.15</b> <b>PK-34.15</b>	18 cm / 7 1/8" <b>PK-33.18</b> <b>PK-34.18</b>	21 cm / 9" <b>PK-33.21</b> <b>PK-34.21</b>
a = 0.5 mm a = 0.5 mm	<b>PK-34.33</b>		<b>PK-33.38</b> <b>PK-34.38</b>	<b>PK-33.41</b> <b>PK-34.41</b>





Молоток хирургический  
MEDICON, 18.5 см, с  
пластиковыми  
накладками, 200 гр,  
диаметр 25 мм

PM-08.18  
18.5 cm / 7 1/4"



Молоток хирургический  
COTTLE, 19 см, торцы 1  
плоский/1 выпуклый, 300  
гр, диаметр 30 мм

COTTLE  
PM-08.40  
19 cm / 7 1/2"



Молоток хирургический  
QUILLEN, 24 см, 300 гр,  
диаметр 30 мм, один  
торец скошенный

GUILLEN  
PM-08.75  
24 cm / 9 1/2"



26 cm / 10 1/4"  
Ø = 35 mm, 150 g **PM-14.35**  
Ø = 45 mm, 240 g **PM-14.45**  
Ø = 50 mm, 330 g **PM-14.50**

Молоток хирургический  
MALLET, 26 см, с пластиковыми  
накладками

**Elevators**

**Элеваторы, распаторы**

# Professional

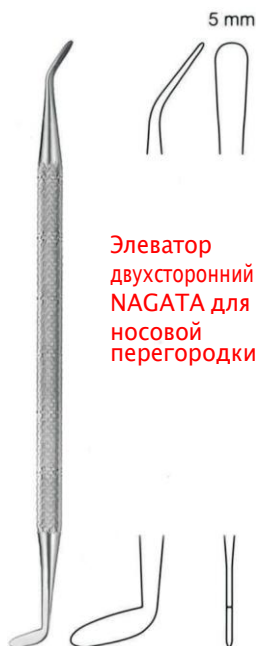

Элеватор  
двухсторонний  
NAGATA для  
носовой  
перегородки

NAGATA  
PT-11.26  
16 cm / 6 1/4"

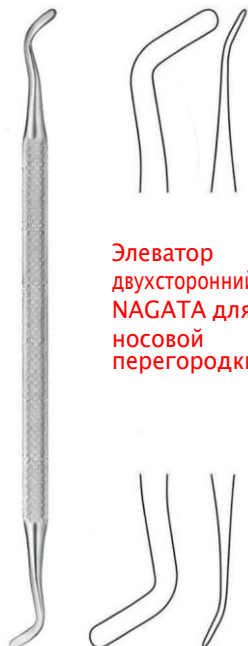

Элеватор  
двухсторонний  
NAGATA для  
носовой  
перегородки

NAGATA  
PT-11.27  
17 cm / 6 3/4"



LANGENBECK  
PT-13.04  
23 cm / 9"

Элеватор LANGENBECK,  
тупоконечный



Распатор  
односторонний  
WILLIGER

WILLIGER  
16 cm / 6 1/4"

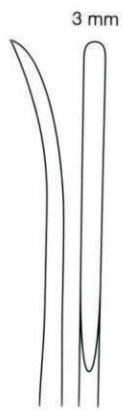

PT-15.03

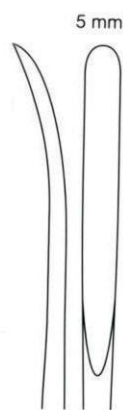

PT-15.05

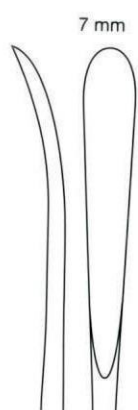

PT-15.07



Элеватор для носовой  
перегородки MCKENTY

MCKENTY  
15 cm / 6"

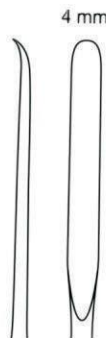

PT-17.04

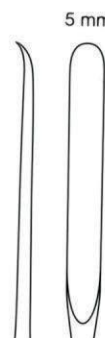

PT-17.05



Распатор двусторонний  
FREER

FREER  
PT-18.01  
19 cm / 7 1/2"

5 mm

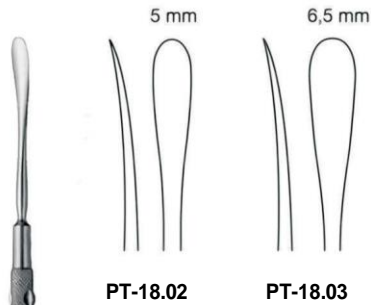

PT-18.02

PT-18.03

Элеватор  
двусторонний  
FREER носовой  
перегородки остро/  
тупоконечный

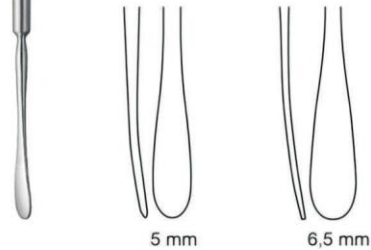

FREER  
19 cm / 7½"

**Raspatories**  
Legras  
Rugines  
Periostotomi

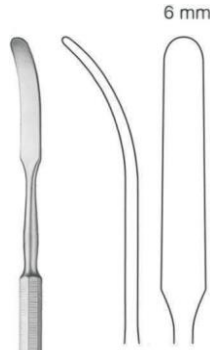

Элеватор / ретрактор  
COHEN двусторонний

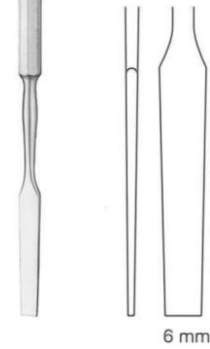

COHEN  
PT-18.24  
24 cm / 9½"



Распатор  
WALTER  
изогнутый

WALTER  
PT-18.38  
14.5 cm / 5¾"



Костная кюретка  
WILLIGER WALTER  
двусторонняя,  
изогнутая, острая

WILLIGER WALTER  
PAC-243.14  
14 cm / 5½"



Распатор носовой  
LEMPERT, прямой

LEMPERT  
17 cm / 6¾"



PT-23.02

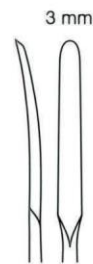

PT-23.03

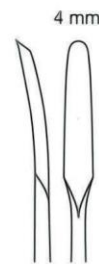

PT-23.04



PT-23.05

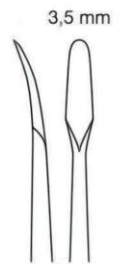

PT-23.06

## Lip and Cleft Palate Instruments

Элеваторы для палатосхизиса (расщелина нёба,  
волчья пасть)

# Professional

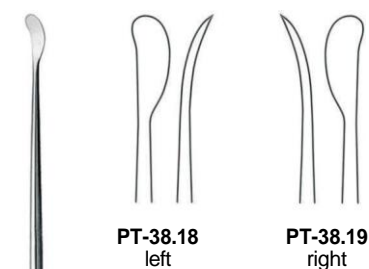

Элеватор Wang односторонний



WANG  
18 cm / 7 1/8"

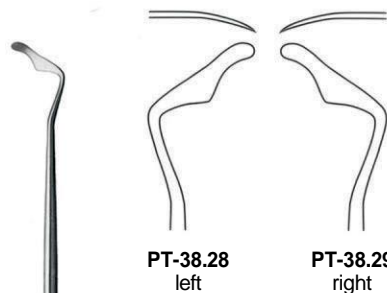

Элеватор Wang односторонний изогнутый



WANG  
18 cm / 7 1/8"

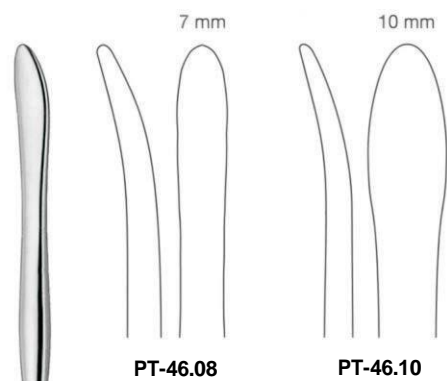

Элеватор LANGENBECK



LANGENBECK  
20 cm / 8"

**Elevators**  
Elevadores  
Elévateurs  
Elevatori

Лигатурные щипцы NIRO (скручивающие), бранши прямоугольные, с насечкой, тип Т/С р/ч из карбида вольфрама

Щипцы для связки лигатур OBWEGESER

Лигатурный зажим OBWEGESER, тип Т/С р/ч из карбида вольфрама



Wire pusher

Бандадаптер для бандажных колец MERSHON, с грушевидной ручкой



MERSHON  
PU-04.50  
14.5 cm / 5 3/4"



NIRO  
PU-04.65  
15 cm / 6"



OBWEGESER  
PU-04.76  
15.5 cm / 6 1/8"



OBWEGESER  
PU-48.43  
13 cm / 5 1/8"

Щипцы для хрящевого трансплантата AIACH, с прорезью

Проволока лигатурная, 0.50 мм, 25 гр

Проволока лигатурная с 2 иглами (атравматика), диаметр 0.15 мм, длина 20 см

5 mm



PU-74.20

Thickness of wire = Ø 0.5 mm



AIACH  
PU-50.56  
16 cm / 6 3/4"

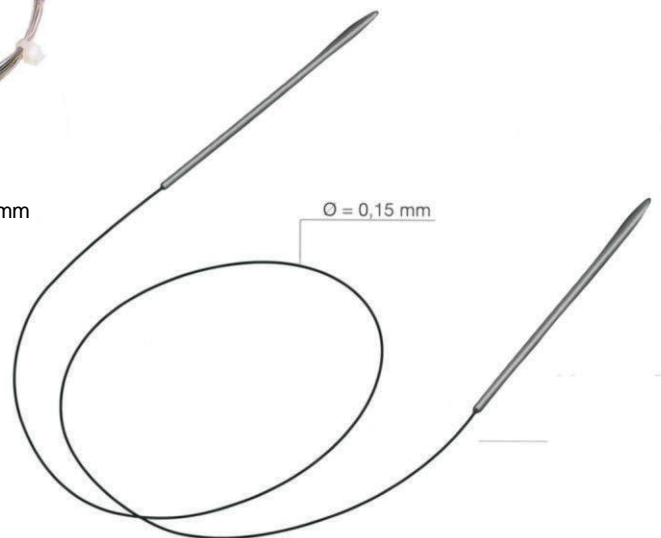

PU-75.40  
20 cm / 8"

Ретрактор SENN MILLER  
двусторонний, 3 зубца

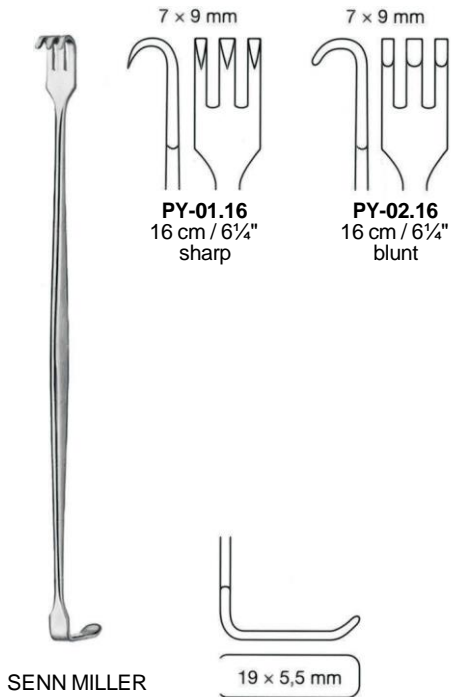

Ретрактор RAGNELL двусторонний



Ретрактор COPE двусторонний



Ретрактор WALTER-COPE двусторонний

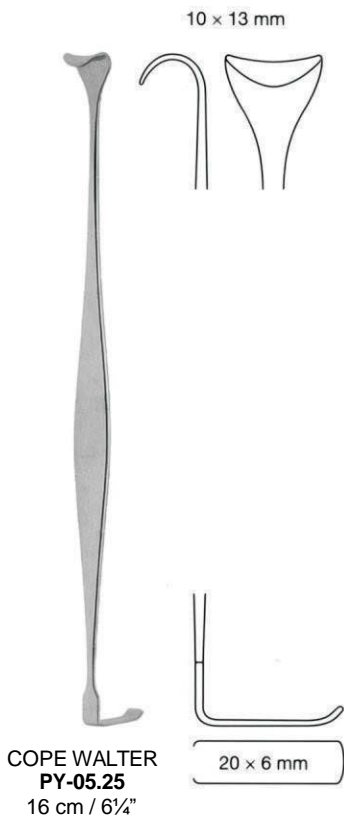

Ретрактор SENN-GREEN, 6x10 мм, 14 см

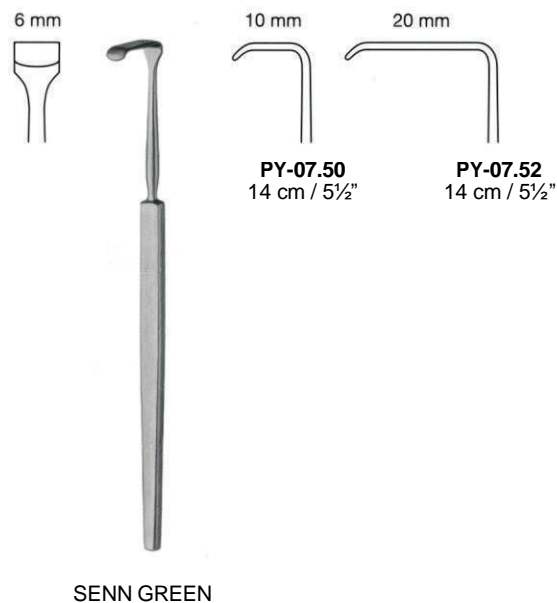

**PY-07.58**  
18 cm / 7 1/8 "

Ретрактор LANGENBECK-GREEN

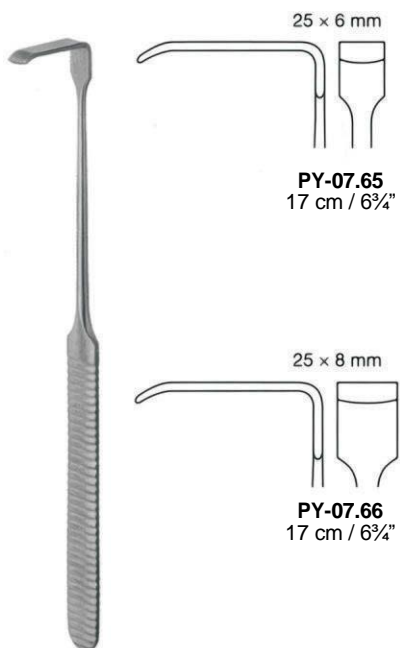

**PY-07.65**  
17 cm / 6<sup>3</sup>/<sub>4</sub>"

**PY-07.66**  
17 cm / 6<sup>3</sup>/<sub>4</sub>"

LANGENBECK GREEN

Ретрактор STRANDELL-STILLE

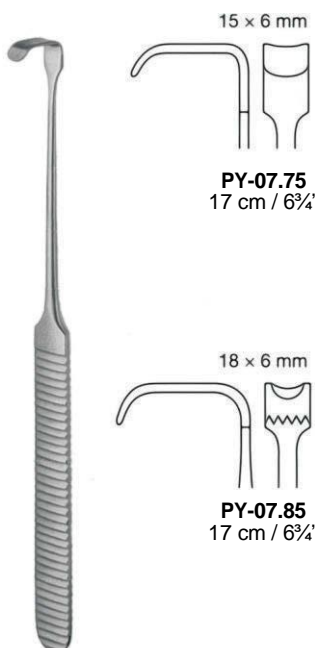

**PY-07.75**  
17 cm / 6<sup>3</sup>/<sub>4</sub>"

**PY-07.85**  
17 cm / 6<sup>3</sup>/<sub>4</sub>"

STRANDELL STILLE

Ретрактор-крючок ADSON

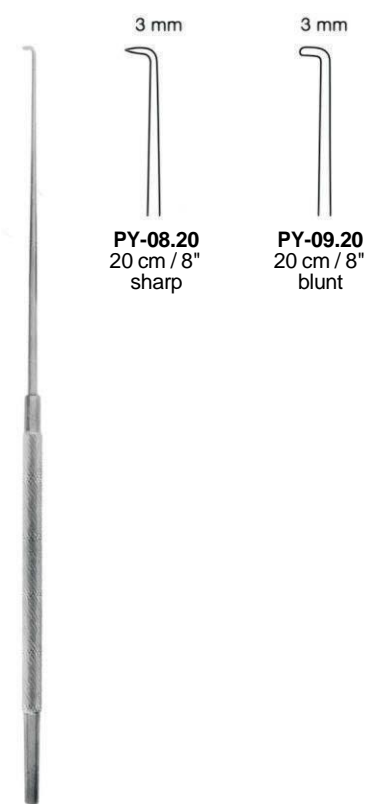

**PY-08.20**  
20 cm / 8"  
sharp

**PY-09.20**  
20 cm / 8"  
blunt

ADSON

Ретрактор-крючок CRILE



**CRILE**  
**PY-10.20**  
20 cm / 8 "

Ретрактор-крючок хирургический острый FRAZIER

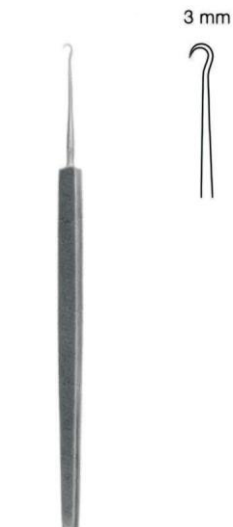

**FRAZIER**  
**PY-11.12**  
12.5 cm / 5 "

Ретрактор-крючок хирургический GILLIES

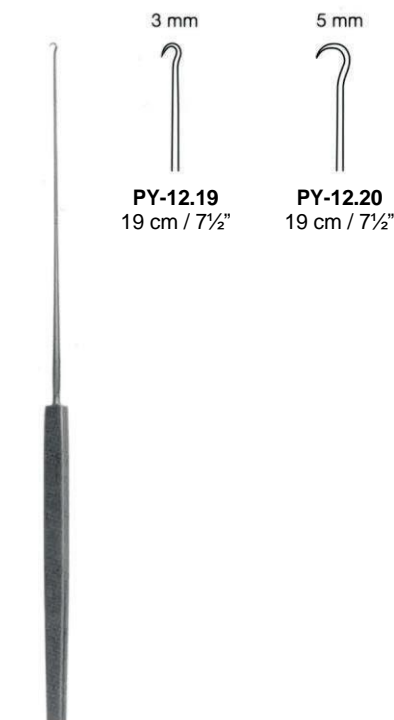

**PY-12.19**  
19 cm / 7<sup>1</sup>/<sub>2</sub>"

**PY-12.20**  
19 cm / 7<sup>1</sup>/<sub>2</sub>"

GILLIES



Ретрактор JOSEPH, острый, 2 зубца

Ретрактор-крючок  
хирургический  
STRAIGHT

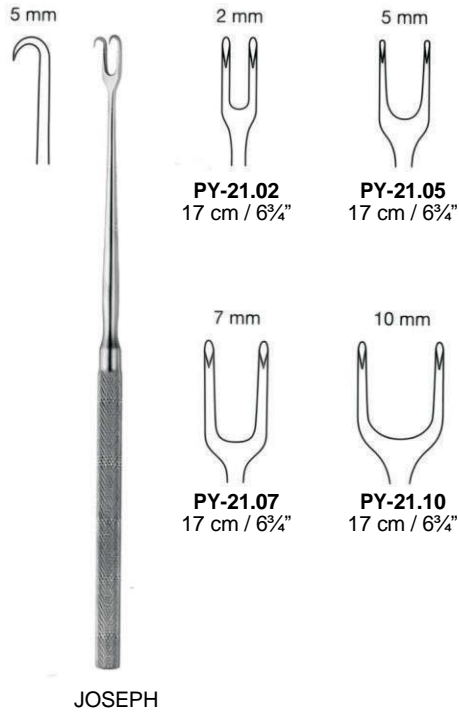

Ретрактор-крючок хирургический KLEINERT KUTZ  
острый

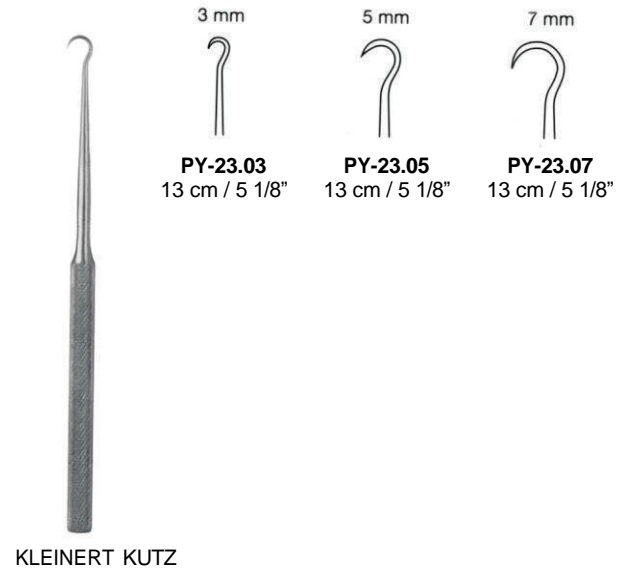

Ретрактор-крючок хирургический BARSKY



Ретрактор-крюк трахеальный JACKSON

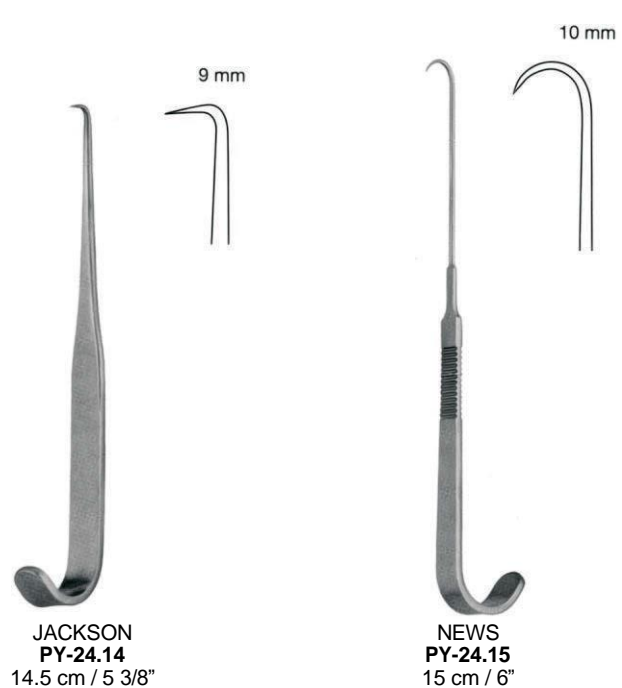

Ретрактор-крючок назальный JOSEPH



Крючок хирургический HUMBY, шарнирный, 2 зубца, острый



Крючок хирургический BERGMANN



Ретрактор-крючок хирургический, однозубый, острый



Крючок хирургический COTTLE клювовидный, острый



Ретрактор - крючок хирургический EMMETT

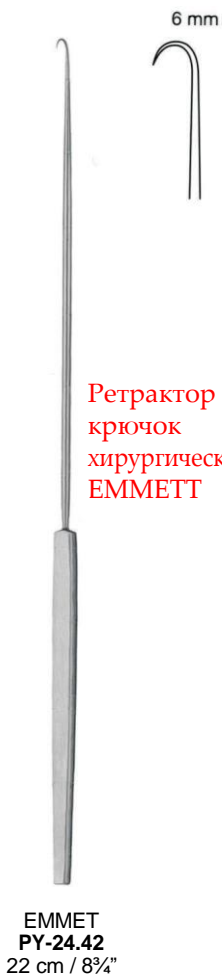

Ретрактор BENICKE, кончик S-изогнутый

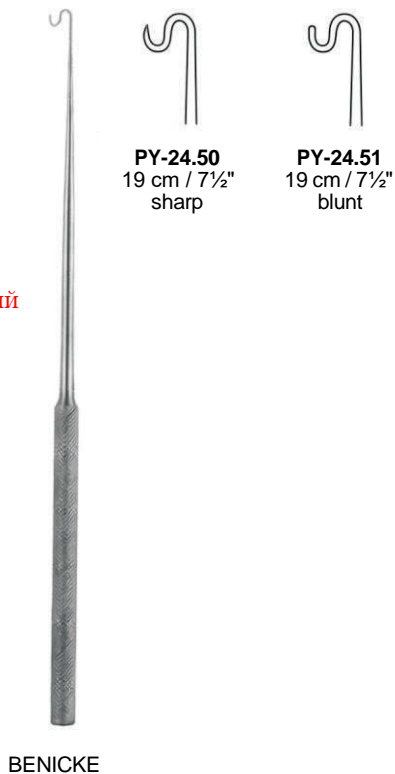

Ретрактор-крючок GUTHRIE, двухзубый, острый

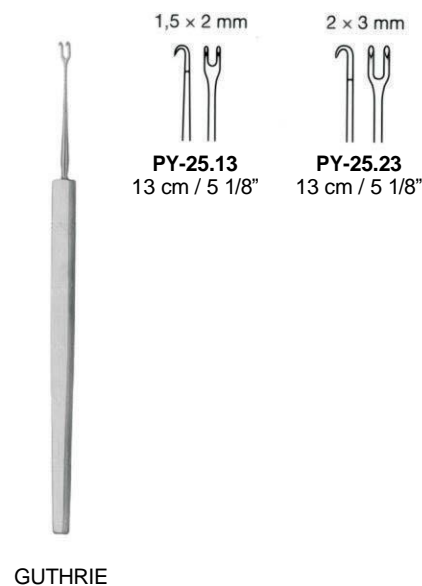

Ретрактор-крючок хирургический

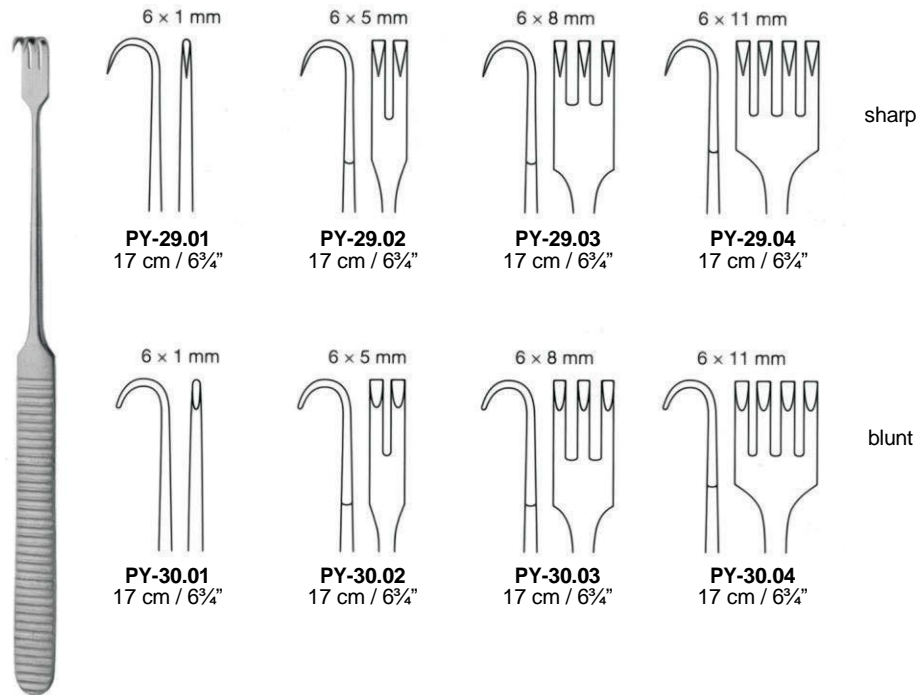

Гибкий крючок-ретрактор с подвижной р/ч

Крючок для нервов  
LAHEY Clinic,  
остроконечный

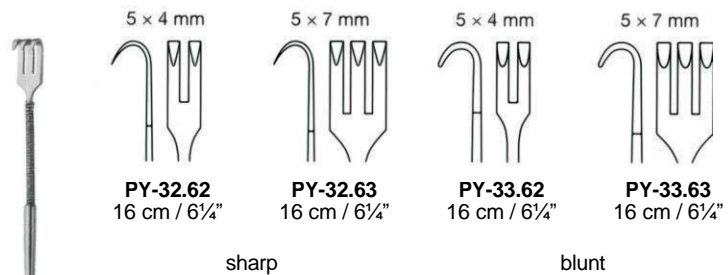

Ретрактор перстневый MEYERDING

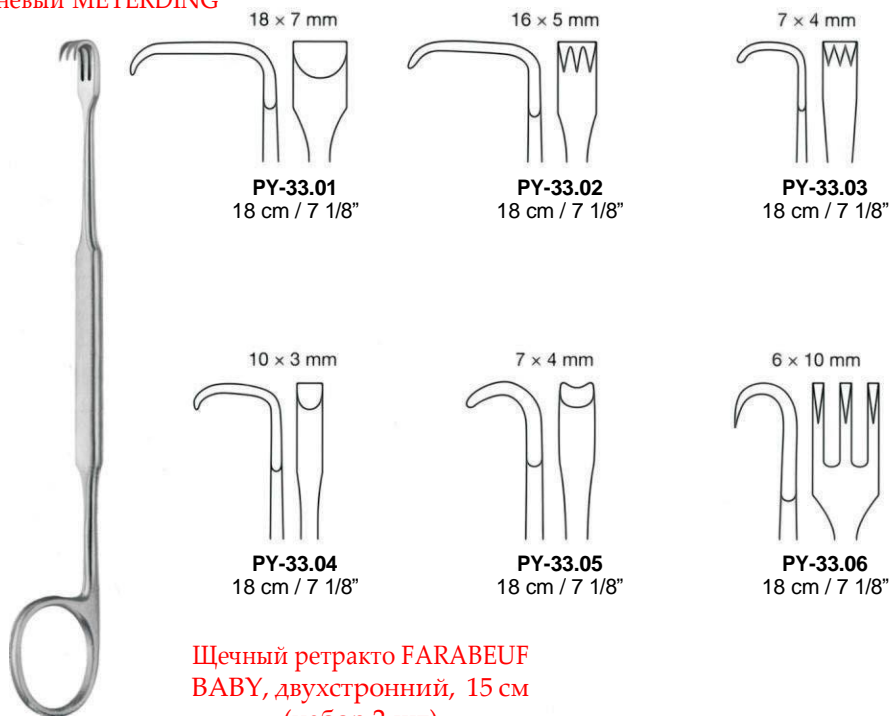

MEYERDING

Щечный ретракто FARABEUF BABY, двухсторонний, 15 см (набор 2 шт)

Щечный ретракто FARABEUF BABY, двухсторонний, 12 см (набор 2 шт)



FARABEUF BABY  
**PY-46.12**  
12 cm / 4 3/4"

FARABEUF  
**PY-47.15**  
15 cm / 6"

Ретрактор WALTER, двухсторонний, 4-зубый

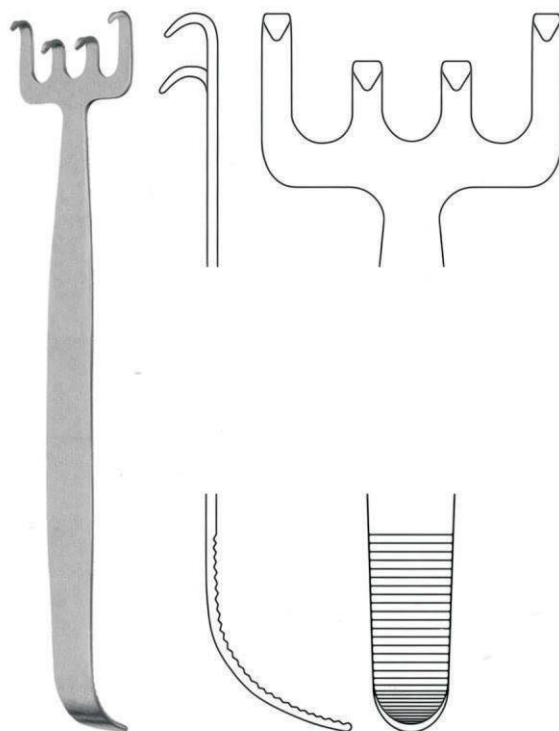

WALTER  
**PY-51.39**  
19 cm / 7 1/2"

## Ретрактор односторонний LANGENBECK

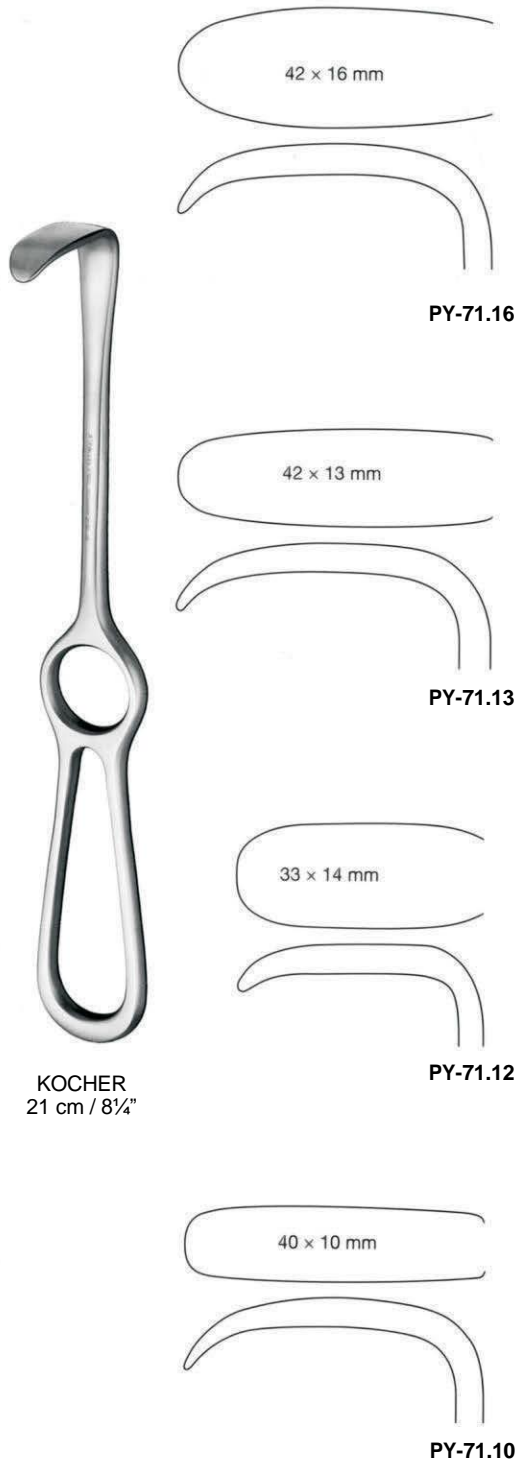

## Ретрактор односторонний KOCHER

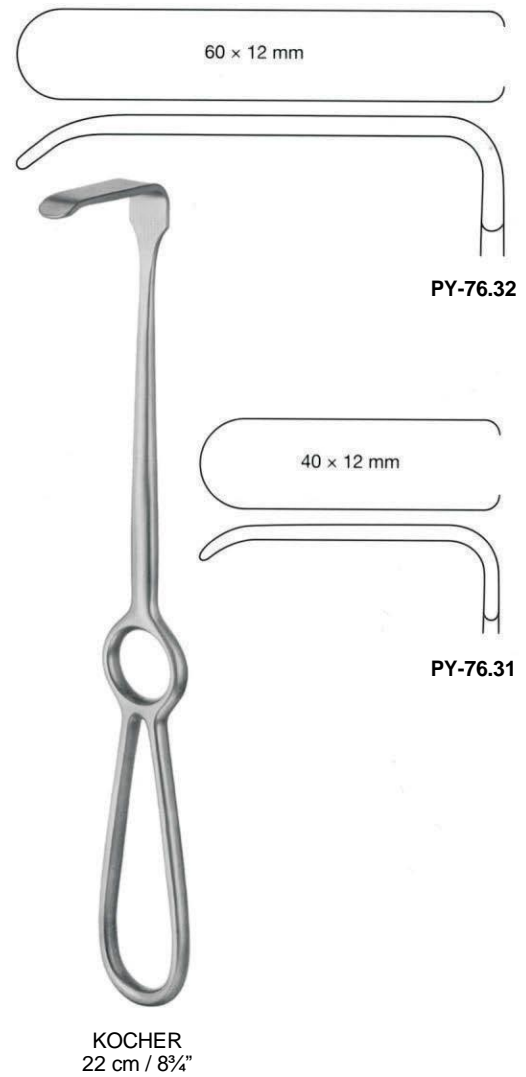

Элеватор для маммопластики, 28 см

Breast elevator



**PY-90.00**  
28 cm / 11"

Емкость для смешивания маркировочного  
пигмента, 60x30 мм, 60 мл

Маркер ареолы SOLZ,  
край притупленный



SOLZ  
Ø = 36 mm **PY-90.20**  
Ø = 40 mm **PY-90.25**  
Ø = 42 mm **PY-90.30**  
Ø = 42 mm **PY-90.35**



**PAF-06.06**  
Ø = 6 cm (0.06l)

Диссектор SOLZ для маммапластики, анатомический, атравматический



Atraumatic breast dissector  
Disector mamario atrumático  
Dissecteur mammaire atraumatique  
Dissettore mammario atraumatico

SOLZ  
PY-90.10  
34 cm / 13 3/8"

PY-90.11  
37 cm / 14 1/2"

Диссектор SOLZ для маммапластики, крючок, атравматический, градуированный, 36 см



Hook dissector  
Disector de gancho  
Crochet Disscteur  
Dissettore a uncino

SOLZ  
PY-90.15  
36 cm / 14 1/8"



Ретрактор для маммапластики Marx, изогнутый

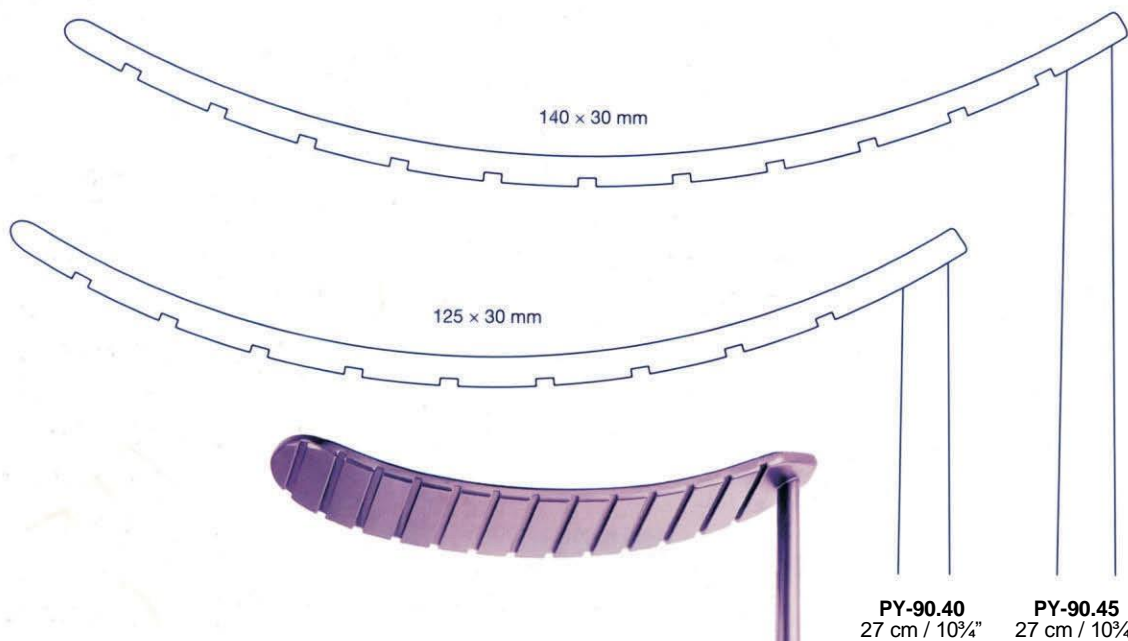

MARX

Абдоминальный ретрактор SALDANHA SOLZ для липоабдоминопластики, 37 см

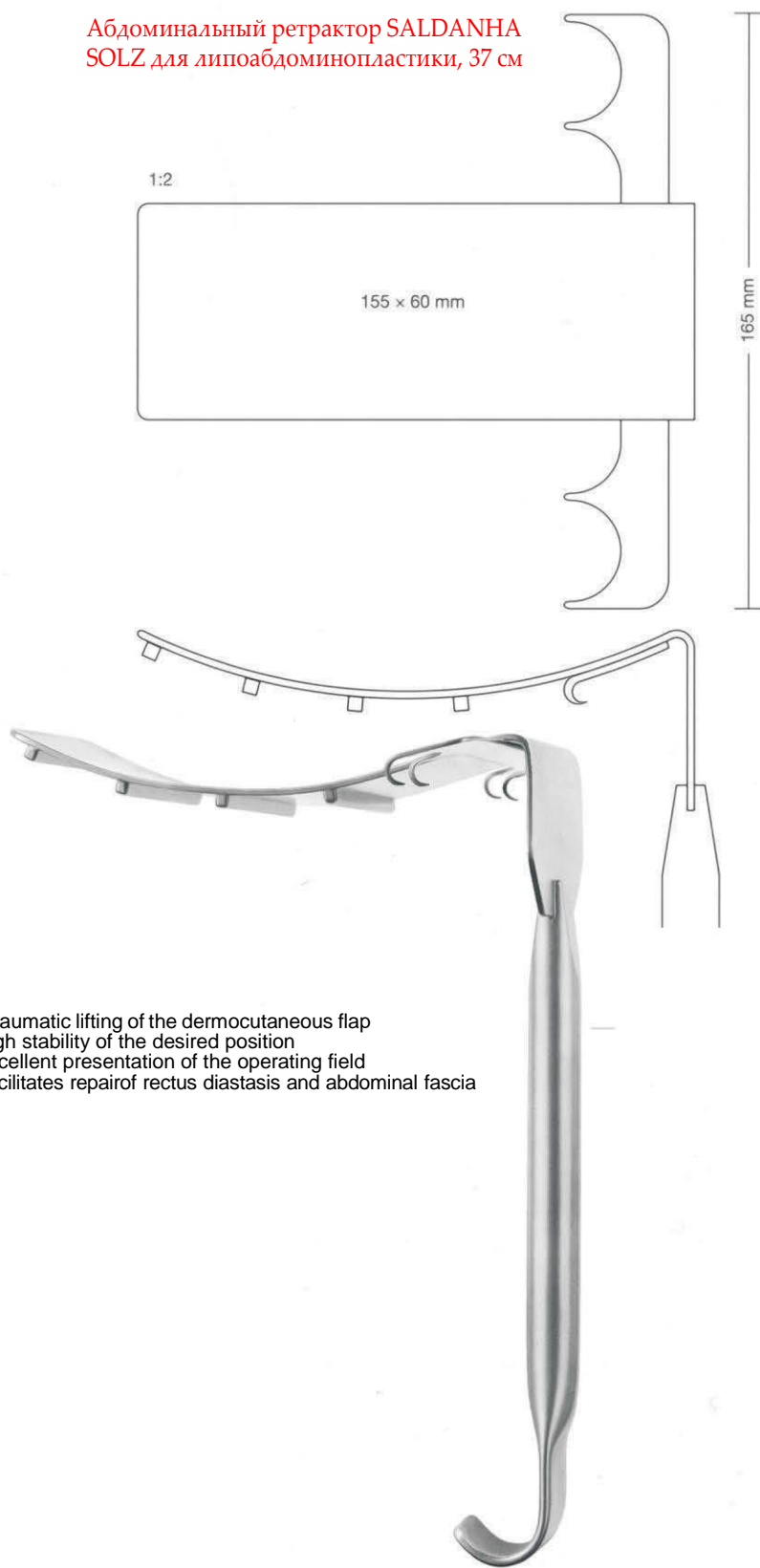

Atraumatic lifting of the dermocutaneous flap  
High stability of the desired position  
Excellent presentation of the operating field  
Facilitates repair of rectus diastasis and abdominal fascia

SALDANHA SOLZ  
PY-90.50  
23.5 cm / 9 1/4"

Маркер (позиционер) пупка SOLZ для точного позиционирования пупка при абдоминопластике, 29 см, 180x40 см

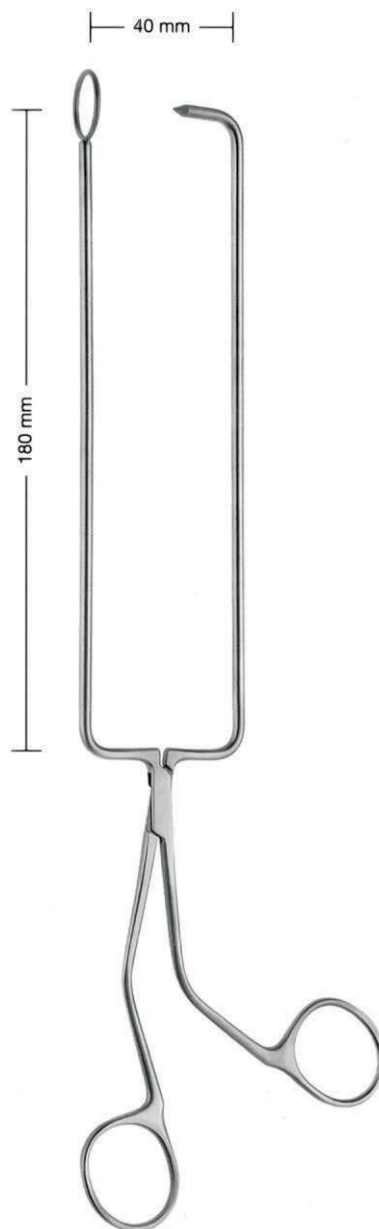

SOLZ  
PY-90.53  
29 cm / 11 3/8"

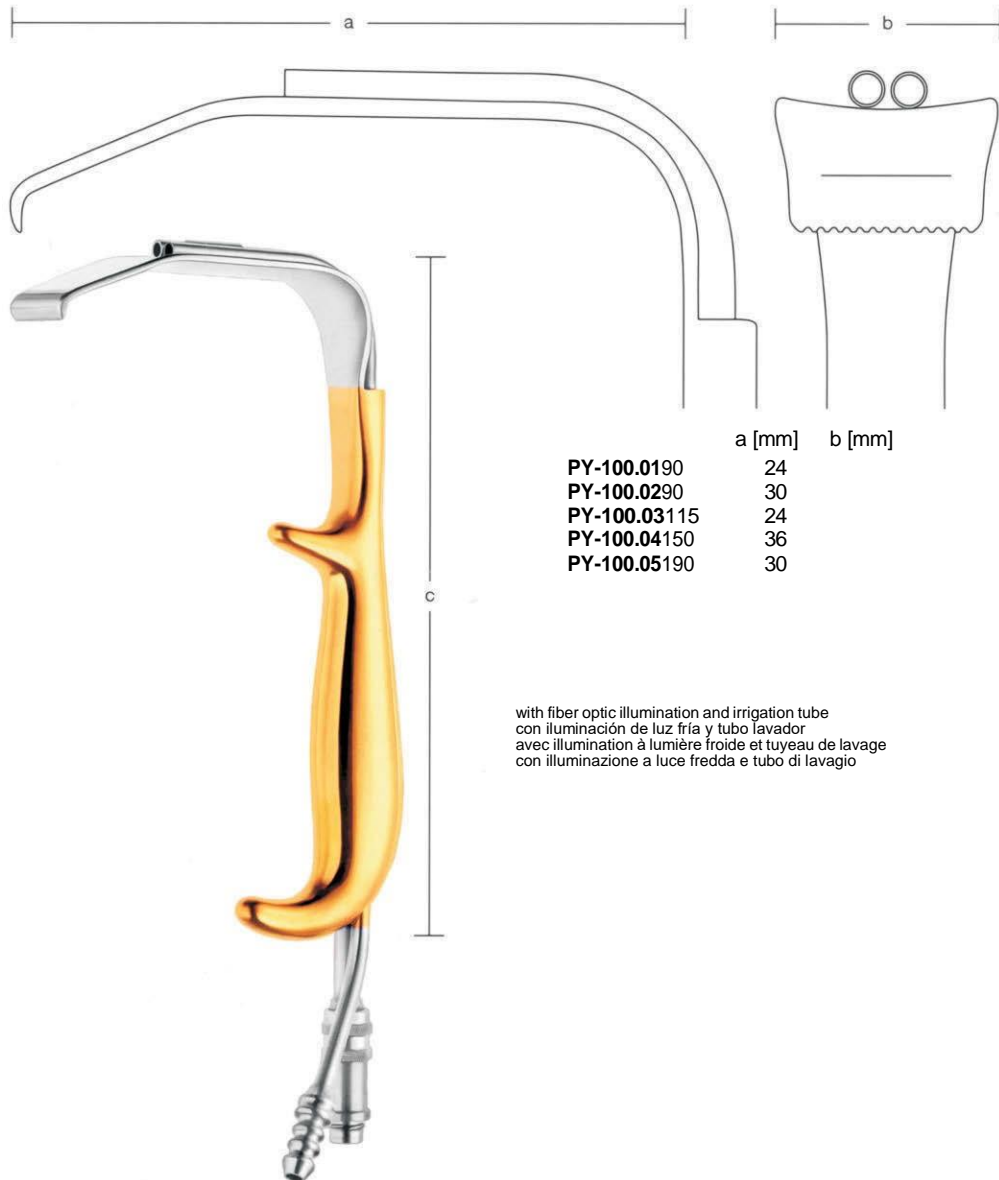

	a [mm]	b [mm]
PY-100.0190	24	
PY-100.0290	30	
PY-100.03115	24	
PY-100.04150	36	
PY-100.05190	30	

with fiber optic illumination and irrigation tube  
con iluminación de luz fría y tubo lavador  
avec illumination à lumière froide et tuyau de lavage  
con illuminazione a luce fredda e tubo di lavaggio

TEBBETTS  
c = 18.5 cm / 7 1/4"

## Self-retracting Retractors

Ранорасширители, ретракторы

# Professional

Ранорасширитель  
(ретрактор) пружинный  
Spring острый

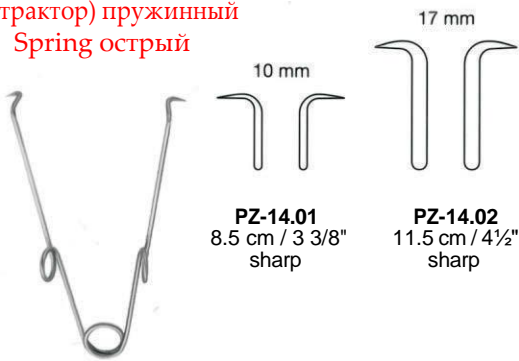

**PZ-14.01**  
8.5 cm / 3 3/8"  
sharp

**PZ-14.02**  
11.5 cm / 4 1/2"  
sharp

Ранорасширитель  
(ретрактор) пружинный  
Spring тупой

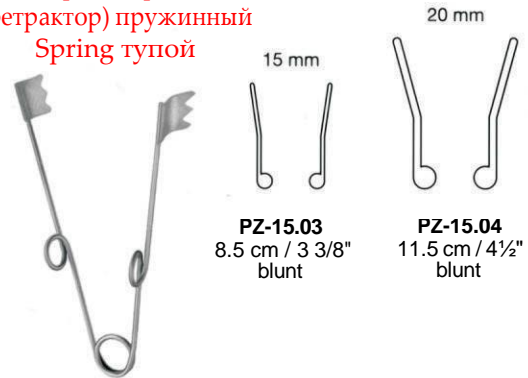

**PZ-15.03**  
8.5 cm / 3 3/8"  
blunt

**PZ-15.04**  
11.5 cm / 4 1/2"  
blunt

Ранорасширитель  
кремалерный SPRING,  
1x1 зуба, острый

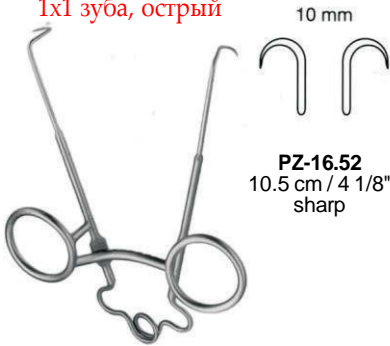

**PZ-16.52**  
10.5 cm / 4 1/8"  
sharp

Ранорасширитель FINSEN

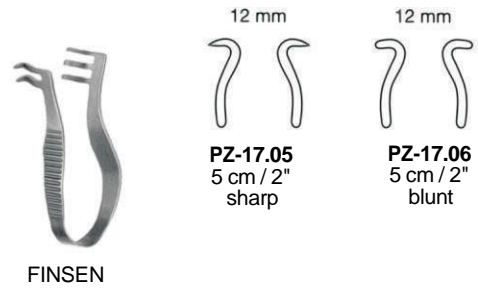

**PZ-17.05**  
5 cm / 2"  
sharp

**PZ-17.06**  
5 cm / 2"  
blunt

FINSEN

Ранорасширитель FINSEN

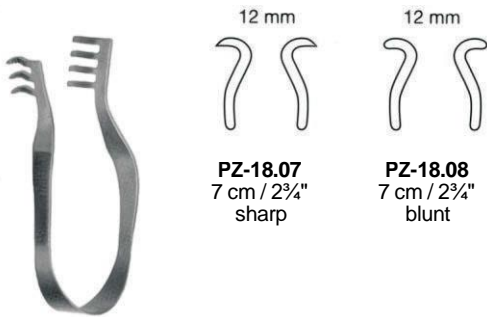

**PZ-18.07**  
7 cm / 2 3/4"  
sharp

**PZ-18.08**  
7 cm / 2 3/4"  
blunt

FINSEN

Ранорасширитель винтовой FINSEN

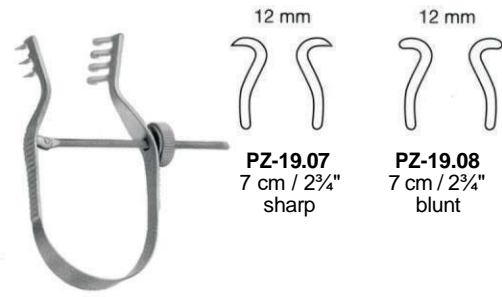

**PZ-19.07**  
7 cm / 2 3/4"  
sharp

**PZ-19.08**  
7 cm / 2 3/4"  
blunt

FINSEN

Ретрактор перекрестного  
действия

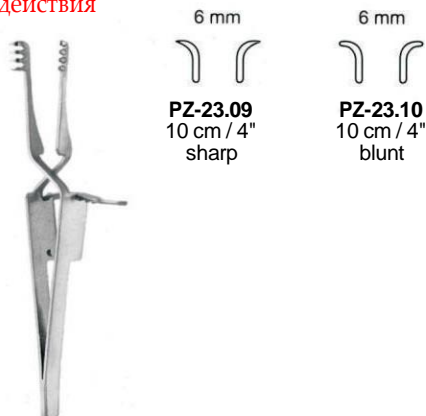

**PZ-23.09**  
10 cm / 4"  
sharp

**PZ-23.10**  
10 cm / 4"  
blunt

Ретрактор ALM раздвижной

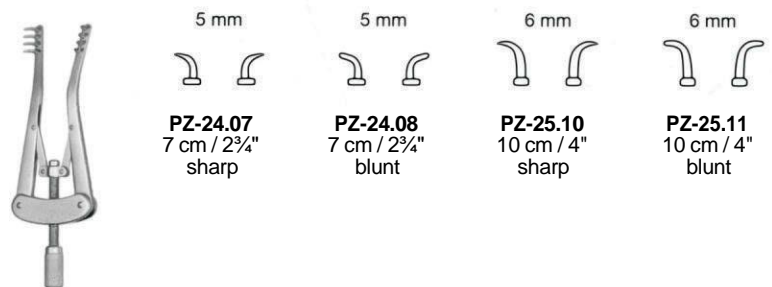

**PZ-24.07**  
7 cm / 2 3/4"  
sharp

**PZ-24.08**  
7 cm / 2 3/4"  
blunt

**PZ-25.10**  
10 cm / 4"  
sharp

**PZ-25.11**  
10 cm / 4"  
blunt

ALM

Ретрактор (ранорасширитель)  
пластинчатый WEITLANER,  
кремальерного типа, 13 см



WEITLANER  
PZ-26.13  
13 cm / 5 1/8"

Ретрактор (ранорасширитель)  
зубчатый WEITLANER,  
кремальерного типа, 10.5 см

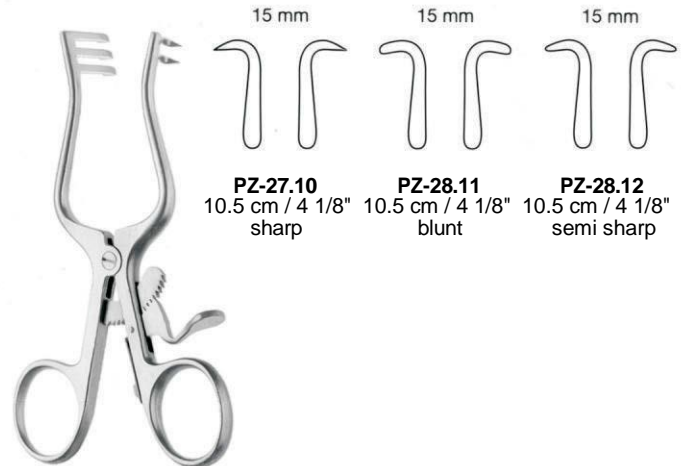

PZ-27.10  
10.5 cm / 4 1/8"  
sharp

PZ-28.11  
10.5 cm / 4 1/8"  
blunt

PZ-28.12  
10.5 cm / 4 1/8"  
semi sharp

WEITLANER

Ретрактор  
(ранорасширитель)  
зубчатый  
WEITLANER,  
кремальерного  
типа, 13 см

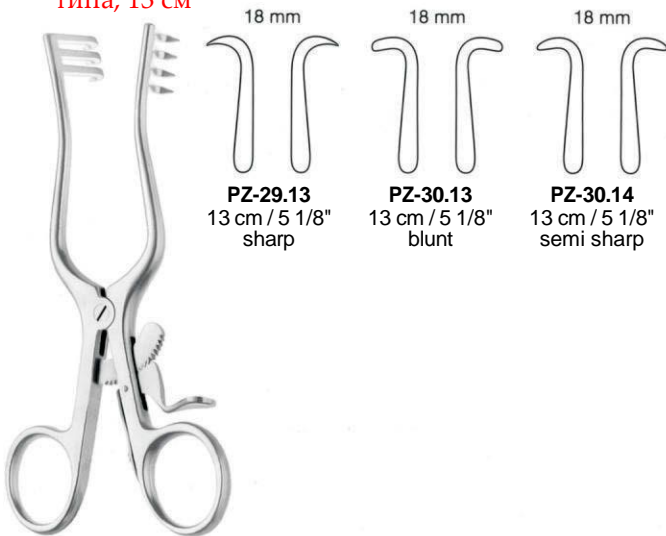

PZ-29.13  
13 cm / 5 1/8"  
sharp

PZ-30.13  
13 cm / 5 1/8"  
blunt

PZ-30.14  
13 cm / 5 1/8"  
semi sharp

WEITLANER

Ретрактор  
(ранорасширитель)  
зубчатый  
WEITLANER,  
кремальерного  
типа, 16 см

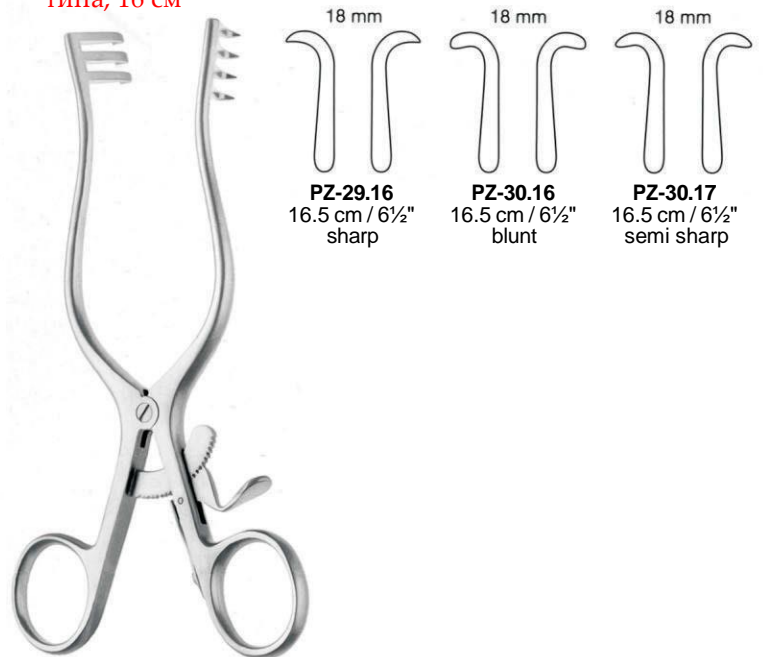

PZ-29.16  
16.5 cm / 6 1/2"  
sharp

PZ-30.16  
16.5 cm / 6 1/2"  
blunt

PZ-30.17  
16.5 cm / 6 1/2"  
semi sharp

WEITLANER

педиатрический

DESMARRES  
ретрактор для века

8 × 10 mm



PAB-164.00  
14 cm / 5½"  
#0

9 × 12 mm

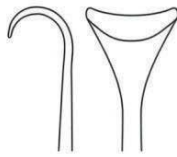

PAB-164.01  
14 cm / 5½"  
#1

10 × 14 mm

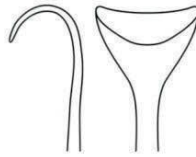

PAB-164.02  
14 cm / 5½"  
#2

10 × 16 mm

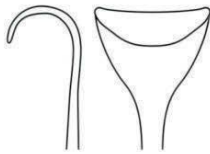

PAB-164.03  
14 cm / 5½"  
#3

12 × 18 mm

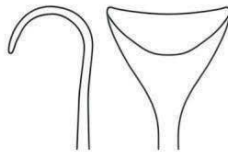

PAB-164.04  
14 cm / 5½"  
#4



DESMARRES

Ретрактор OBWEGESER  
нижнечелюстной

45 × 9/12 mm

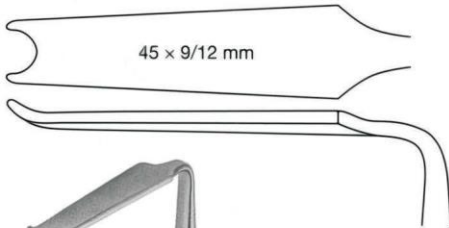

OBWEGESER  
PAS-09.17  
17 cm / 6¾"

Ретрактор  
OBWEGESER  
нижнечелюстной

70 × 11/15 mm

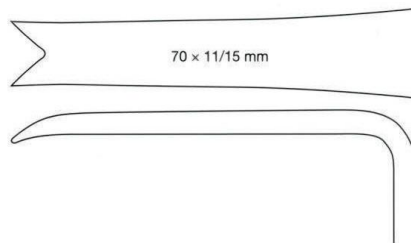

PAS-09.26

70 × 12/22 mm

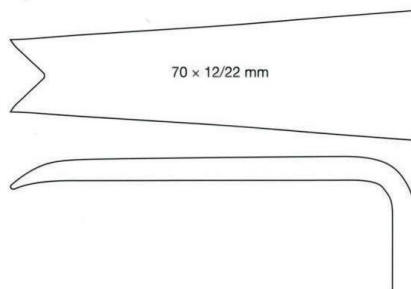

PAS-09.27



OBWEGESER  
22 cm / 8¾"



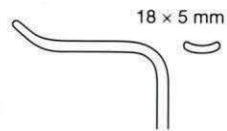

PAS-09.31

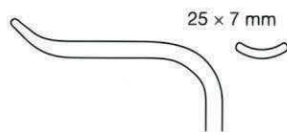

PAS-09.32

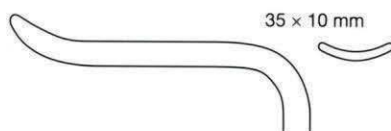

PAS-09.33

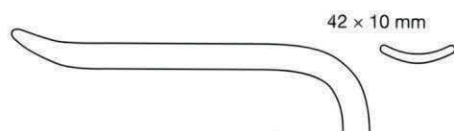

PAS-09.34

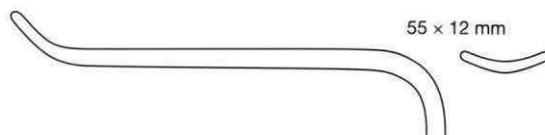

PAS-09.35



PAS-09.36

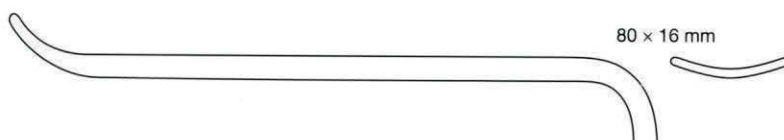

PAS-09.37

Ретрактор OBWEGESER  
для мягких тканей,  
изогнутый кверху



OBWEGESER  
23 cm / 9"

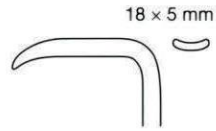

PAS-09.41

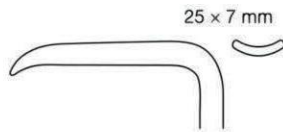

PAS-09.42

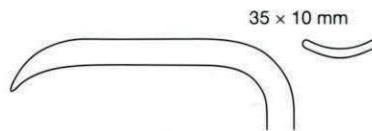

PAS-09.43

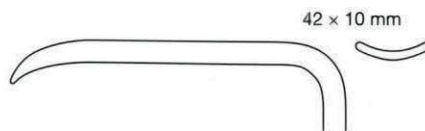

PAS-09.44



PAS-09.45

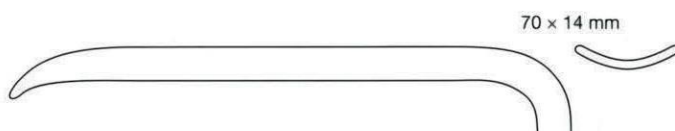

PAS-09.46

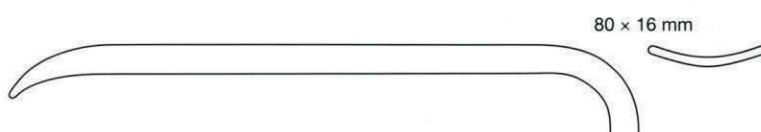

PAS-09.47

Ретрактор OBWEGESER для  
мягких тканей, изогнутый  
книзу



OBWEGESER  
22.5 cm / 9"

Ретрактор OBWEGESER щечный,  
для удаления зуба мудрости



OBWEGESER  
PAS-09.63  
22.5 cm / 9"

Ретрактор OBWEGESER для  
носовой перегородки



OBWEGESER  
PAS-09.65  
22.5 cm / 9"

Ретрактор OBWEGESER для подвздошной кости



OBWEGESER

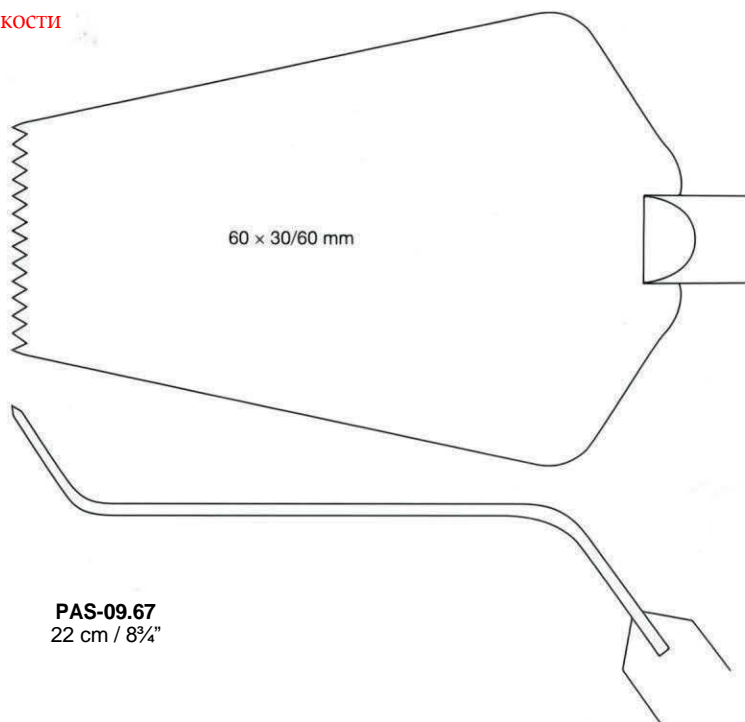

PAS-09.67  
22 cm / 8¾"

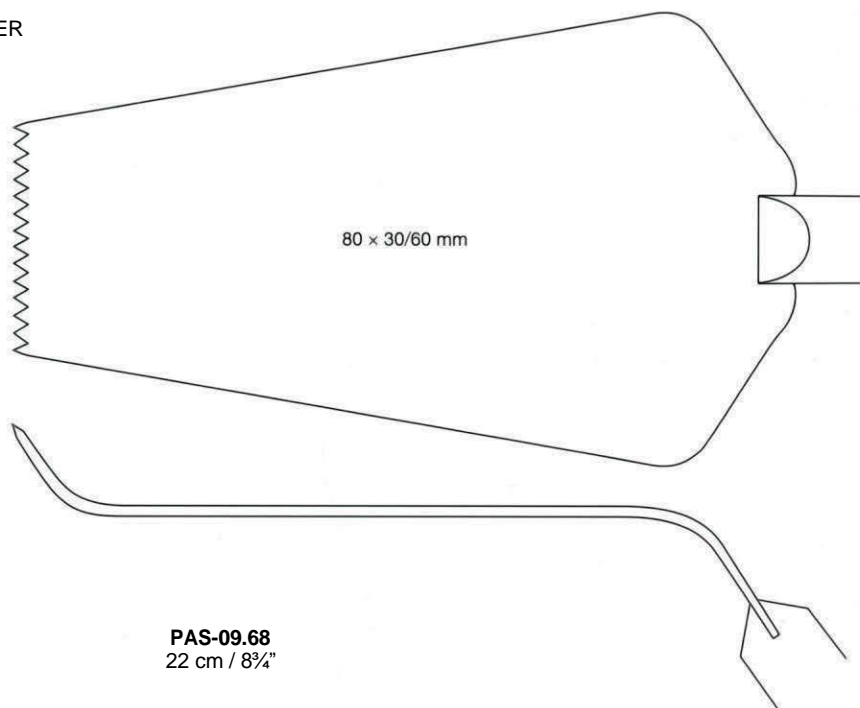

PAS-09.68  
22 cm / 8¾"

## Ретрактор для прогени OBWEGESER



OBWEGESER

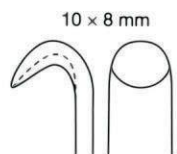

PAS-10.26  
17.5 cm / 7"

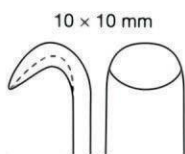

PAS-10.27  
17.5 cm / 7"

## Ретрактор OBWEGESER CHIN для подбородка



OBWEGESER  
PAS-10.28  
16 cm / 6 1/4"

## Распатор реберный DOYEN

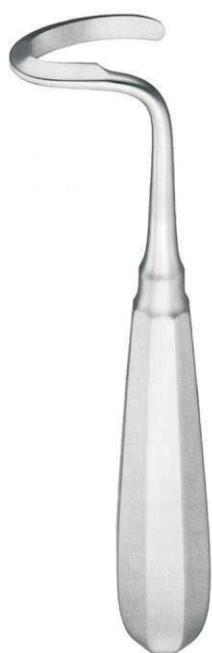

DOYEN  
17 cm / 6 3/4"

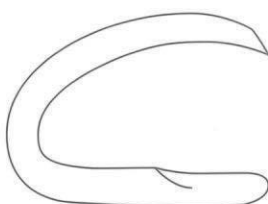

PAG-46.11  
right

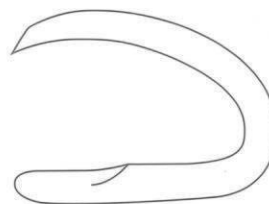

PAG-46.12  
left

Щипцы назальные HARTMANN для тампонады, изогнутые по плоскости



HARTMANN  
PAM-04.16  
18 cm / 7 1/8"



HARTMANN  
PAM-05.20  
20 cm / 8"

Щипцы назальные WESTMACOTT для тампонады, изогнутые по плоскости



WESTMACOTT  
20 cm / 8"

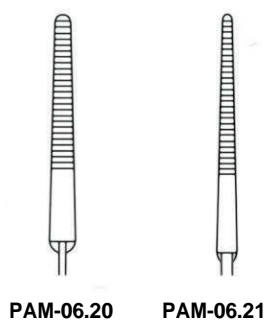

PAM-06.20

PAM-06.21

Щипцы назальные LUBET-BARBON для тампонады, изогнутые по плоскости



LUBET BARBON  
PAM-06.30  
20 cm / 8"

Назальное зеркало HARTMANN



HARTMANN



PAM-08.15  
15 cm / 6"

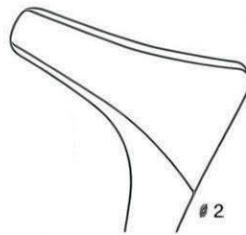

PAM-08.16  
15 cm / 6"

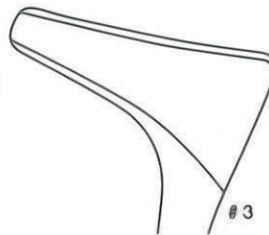

PAM-08.17  
15 cm / 6"

Назальное зеркало TIECK-HALLE



TIECK HALLE

детское

для младенцев



PAM-09.10  
13.5 cm / 5 3/4"

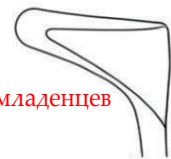

PAM-09.11  
13.5 cm / 5 3/4"

Зеркало назальное COTTLE с фиксатором

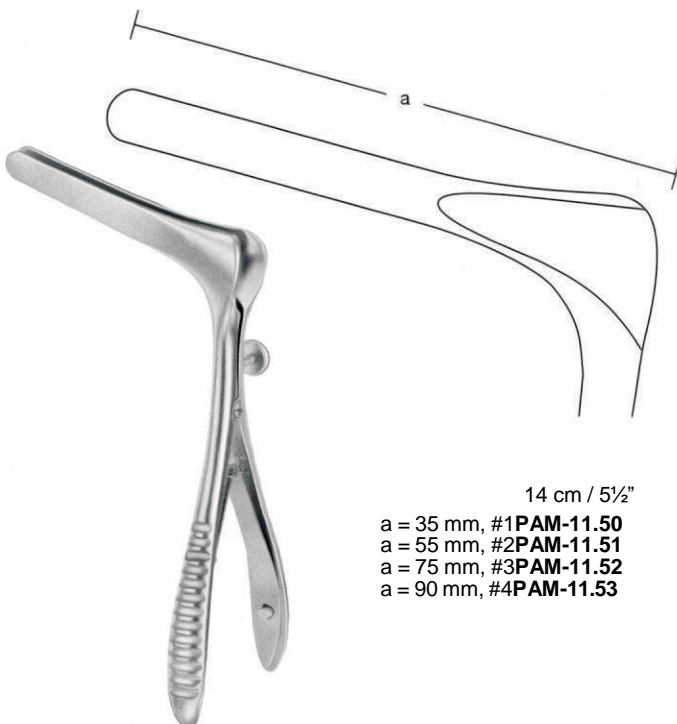

COTTLE

14 cm / 5 1/2"

a = 35 mm, #1 PAM-11.50  
a = 55 mm, #2 PAM-11.51  
a = 75 mm, #3 PAM-11.52  
a = 90 mm, #4 PAM-11.53



COTTLE  
PAM-11.60  
14 cm / 5 1/2"

Зеркало назальное  
COTTLE, лезвия  
50 мм, 14 см



Зеркало назальное COTTLE  
деликатное, 13 см



COTTLE  
PAM-11.62  
13 cm / 5 1/8"

Назальное зеркало модель Wien (VIENNA) #1, лезвия 30 мм, 15 см



"MOD. WIEN"

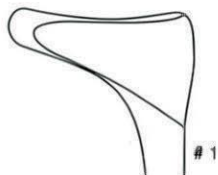

PAM-16.15  
14 cm / 5 1/2"

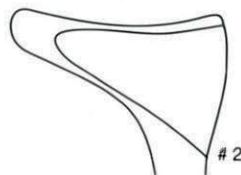

PAM-16.16  
14 cm / 5 1/2"

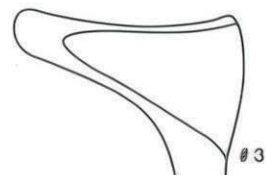

PAM-16.17  
14 cm / 5 1/2"



Назальное  
зеркало  
KILLIAN



KILLIAN

14 cm / 5 1/2"  
a = 35 mm, #1 PAM-14.14  
a = 50 mm, #2 PAM-14.15  
a = 75 mm, #3 PAM-14.16  
a = 90 mm, #4 PAM-14.17

Назальное зеркало  
KILLIAN-ASEPT #4  
(модифицированное)



KILLIAN  
PAM-14.59  
14 cm / 5 1/2"



Пинцет COTTLE  
COLUMELLA,  
ширина бранш  
12 мм, 11 см

COTTLE  
PAN-67.11  
11 cm / 4 3/8"

Распатор  
 носовой  
 FREER, 16 см



FREER  
 PAM-20.16  
 16 cm / 6 1/4"



Долото хирургическое  
 BALLENGER  
 V-образное



BALLENGER  
 16 cm / 6 1/4"

4 mm



PAM-24.16

6 mm



PAM-24.17

Долото хирургическое FREER V-образное



FREER  
 15.5 cm / 6 1/8"

4 mm



PAM-25.16

6 mm



PAM-25.17



KILLIAN  
 PAM-25.46  
 17.5 cm / 7"

Долото  
 хирургическое  
 KILLIAN  
 желобчатое

6 mm



KILLIAN CLAU  
 PAM-25.47  
 17 cm / 6 3/4"

Долото  
 хирургическое  
 KILLIAN CLAU  
 желобчатое

6 mm



PAM-30.50  
 20 cm / 8"

Распатор носовой  
 PENNINGTON  
 двухсторонний



Зажим назальный LUC-BRUNINGS (HEYMANN)



PAM-34.11

PAM-34.12

LUC BRUNINGS  
(HEYMANN)  
18 cm / 7 1/8"

Пинцет назальный CRAIG, 17 см



CRAIG  
PAM-34.15  
17 cm / 6 3/4"

Щипцы для носовой перегородки CRAIG-DOMNICK, 17 см



PAM-34.16

PAM-34.17

CRAIG DOMNICK  
17 cm / 6 3/4"

Зажим назальный HEYMANN, изогнутый по плоскости, р/ч с насечками, 18 см



HEYMANN  
PAM-34.75  
18 cm / 7 1/8"

Назальные щипцы прямые WEIL-BLAKESLEY-WILDE



	straight	angled upwards 45°	angled upwards 90°
3,0 mm			
	PAM-44.01	PAM-44.11	PAM-45.11
3,6 mm			
	PAM-44.02	PAM-44.12	PAM-45.12
with normal shaft	4,2 mm		
	PAM-44.03	PAM-44.13	PAM-45.13
	4,8 mm		
	PAM-44.04	PAM-44.14	PAM-45.14
	5,6 mm		
	PAM-44.05	PAM-44.15	PAM-45.15

Назальные щипцы прямые WEIL-BLAKESLEY, тонкие

		45°
3,0 mm		
	PAM-44.71	PAM-44.81
3,6 mm		
	PAM-44.72	PAM-44.82
with slim shaft	4,2 mm	
	PAM-44.73	PAM-44.83
	4,8 mm	
	PAM-44.74	PAM-44.84
	5,6 mm	
	PAM-44.75	PAM-44.85

Назальные щипцы прямые WEIL-BLAKESLEY,  
длина 11.5 см, режущие

11,5 cm - 4 1/2"



WEIL BLAKESLEY

2,0 mm 

2,5 mm 

3,0 mm 

straight



PAM-44.26

angled upwards



PAM-44.35

angled upwards



PAM-44.60

angled upwards



PAM-44.61

Назальные щипцы прямые BLAKESLEY, длина 11.5 см, бранши 3.0 мм (ложка)

11,5 cm - 4 1/2"



BLAKESLEY

3,0 mm 

straight



PAM-44.59

Крючок (ретрактор)  
назальный FOMON

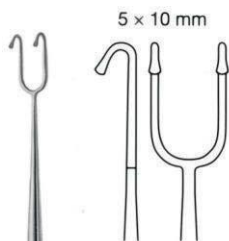

FOMON  
PAN-01.17  
17 cm / 6 3/4"

Носовой ретрактор - подъемник MASING,  
двухсторонний, градуированный

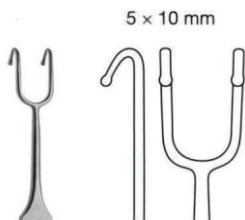

Носовой  
ретрактор  
NEIVERT,  
двухсторонний,  
градуированный

NEIVERT  
PAN-01.19  
19 cm / 7 1/2"

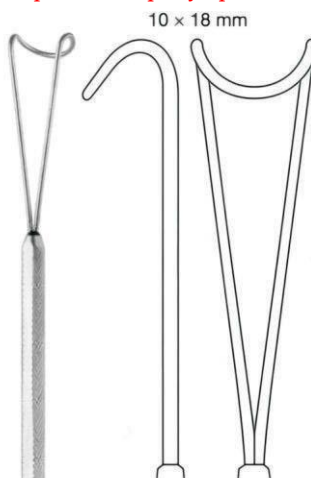

MASING  
PAN-01.20  
20 cm / 8"

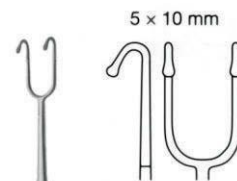

Ретрактор носовой  
COTTLE NEIVERT,  
двухсторонний

COTTLE NEIVERT  
PAN-01.21  
21 cm / 8 1/4"

Ретрактор носовой MILLARD  
COTTLE с кольцом для  
пальца

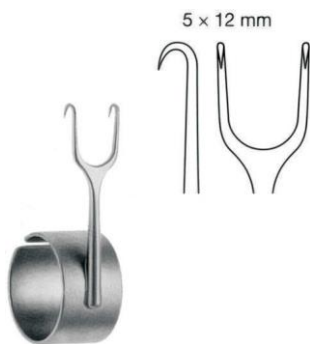

MILARD (COTTLE)  
PAN-01.23  
5.5 cm / 2 1/8"

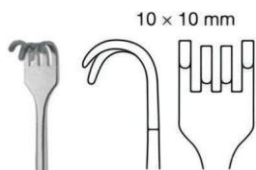

Ретрактор  
носвой  
COTTLE, 4  
зубца,  
тупоконечный

COTTLE  
PAN-01.44  
15 cm / 6"

Крючок (ретрактор) назальный COTTLE

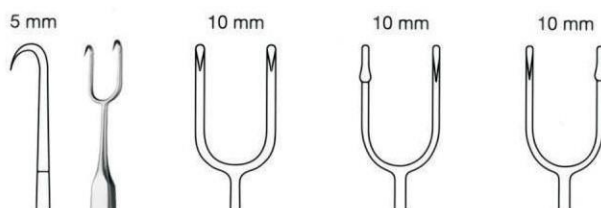

PAN-02.14

PAN-03.14

PAN-04.14

COTTLE  
15 cm / 6"

Nasal Retractors

Ретракторы назальные

# Professional

Крючок (ретрактор) назальный  
COTTLE, 2 зубца, острый



COTTLE  
PAN-04.15  
15 cm / 6"

Ретрактор носовой  
KILNER, острый

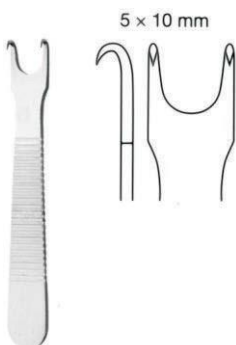

KILNER  
PAN-04.10  
10 cm / 4"

Ретрактор COTTLE  
крыловидный

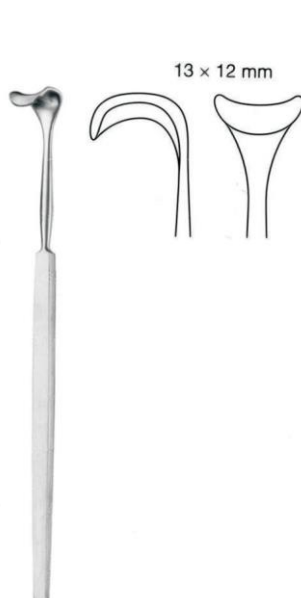

COTTLE  
PAN-05.14  
14 cm / 5 1/2"

Ретрактор COTTLE крыловидный

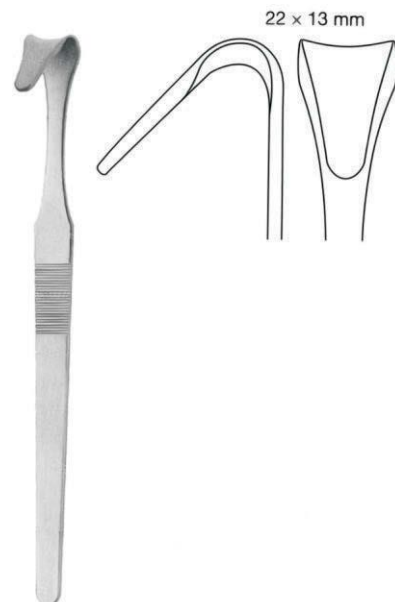

COTTLE  
PAN-05.16  
15 cm / 6"

Ретрактор назальный AUFRICHT WALTER, двухсторонний

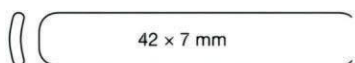

острый  
PAN-06.14

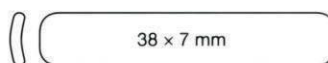

тупоконечный  
PAN-06.15

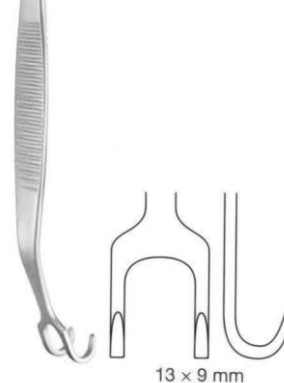
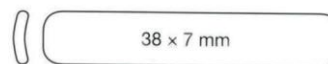

AUFRICHT  
PAN-06.17  
13.5 cm / 5 3/8"

AUFRICHT WALTER  
13.5 cm / 5 3/8"

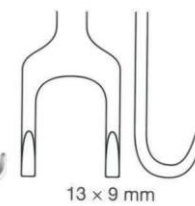
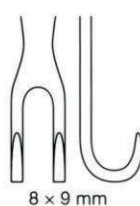
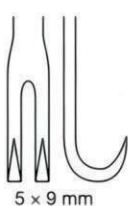

Ретрактор WALTER с гильзой для ф/о, 18,5 см

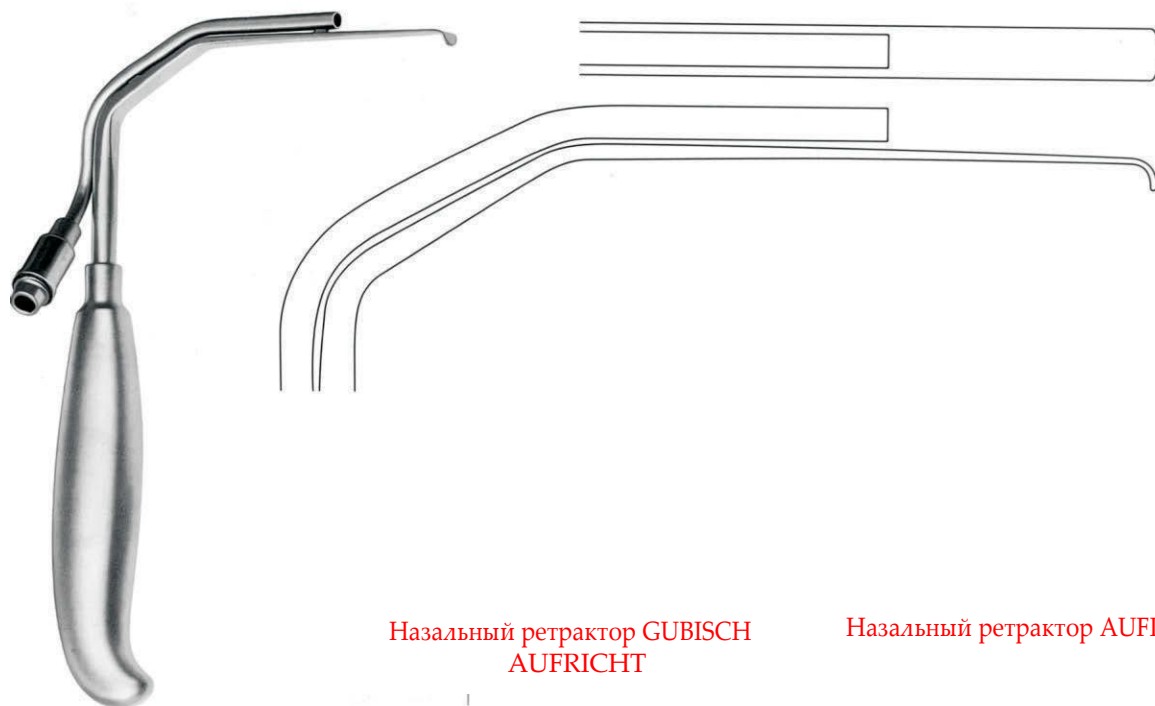

PAN-06.30  
18.5 cm / 7 1/4"

Назальный ретрактор GUBISCH  
AUFRICHT

Назальный ретрактор AUFRICHT

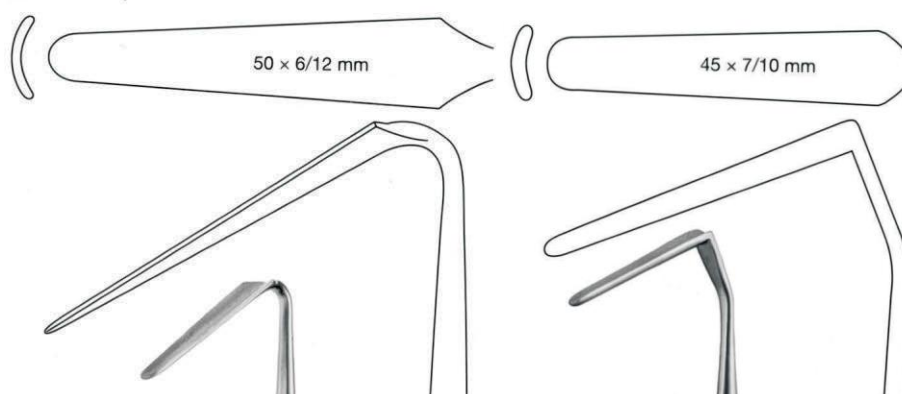

Ретрактор CONVERSE  
двухсторонний,  
остроконечный

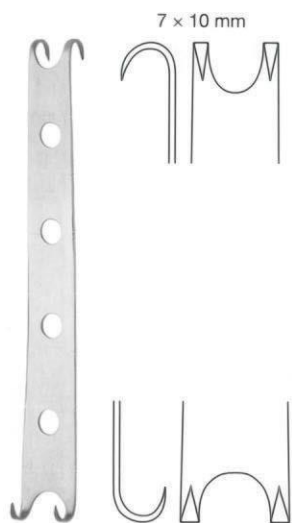

CONVERSE  
PAN-09.12  
12 cm / 4 3/4"



GUBISCH AUFRICHT  
PAN-10.17  
17 cm / 6 3/4"



AUFRICHT  
PAN-10.19  
18 cm / 7 1/8"



## Rhinoplasty Knives

Ножи, пилки для ринопластики

# Professional

Нож для ринопластики  
COTTLE, двухсторонний,  
изогнутый, 14 см



COTTLE  
PAN-15.14  
14 cm / 5½"

Нож для  
ринопластики  
JOSEPH,  
тупоконечный,  
прямой, 15 см



JOSEPH  
PAN-12.15  
15 cm / 6"

Нож для  
ринопластики  
COTTLE,  
двухсторонний,  
прямой, 14 см

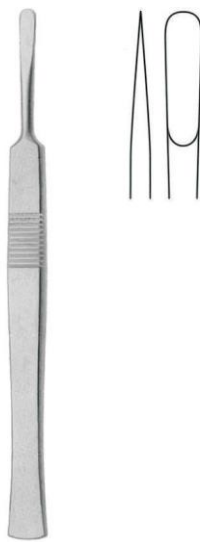

COTTLE  
PAN-13.14  
14 cm / 5½"

Нож для ринопластики  
угловой JOSEPH,  
тупоконечный, 16 см



JOSEPH  
PAN-13.16  
16 cm / 6¼"

Нож для ринопластики  
CONVERSE,  
тупоконечный,  
изогнутый, 15 см



CONVERSE  
PAN-14.15  
15 cm / 6"

Пила назальная JOSEPH, изогнута влево, 17 см

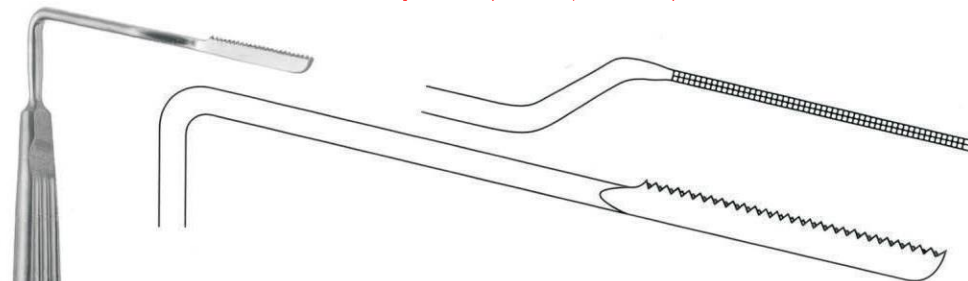

Нож для  
ринопластики  
COTTLE,  
двухсторонний,  
прямой, 14 см



COTTLE  
PAN-15.14  
14 cm / 5½"

JOSEPH  
PAN-17.26  
12.5 cm / 5"

Пила назальная JOSEPH, изогнута вправо, 17 см

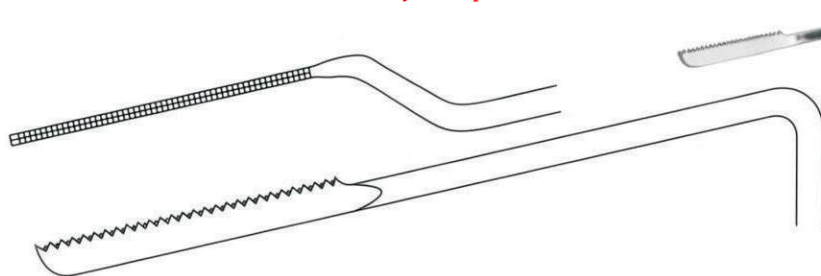

JOSEPH  
PAN-17.27  
12.5 cm / 5"

Пилка назальная JOSEPH, байонетная, 17 см

Пилка назальная JOSEPH, прямая, 17см

Рашпиль COTTLE, прямой, с обратной насечкой, 21 см

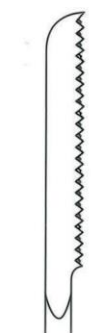

PAN-20.24  
left



PAN-18.24  
right

JOSEPH  
17 cm / 6 $\frac{3}{4}$ "



JOSEPH  
PAN-19.24  
17 cm / 6 $\frac{3}{4}$ "

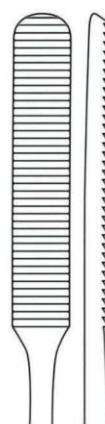

COTTLE  
PAN-21.24  
21 cm / 8 $\frac{1}{4}$ "

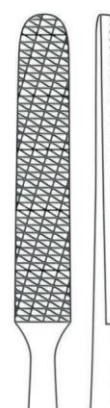

Рашпиль COTTLE, тип T/C р/ч из карбида вольфрама, мелкая насечка, 20.5см

COTTLE  
PAN-21.25  
20.5 cm / 8"

Рашпиль носовой MALTZ, прямой, с обратной насечкой, 18.5 см

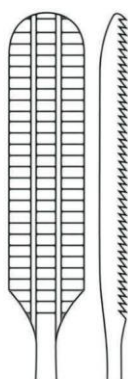

MALTZ  
PAN-22.25  
18.5 cm / 7 $\frac{1}{4}$ "

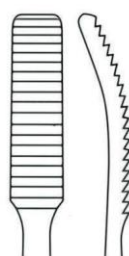

Рашпиль носовой, р/ч изогнута по дуге, с прямой насечкой, 19.5 см

PAN-23.47  
19.5 cm / 7 $\frac{3}{4}$ "

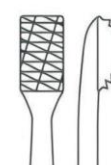

Рашпиль носовой LEWIS, тип T/C, р/ч из карбида вольфрама, округлой формы, 19.5 см

LEWIS  
PAN-23.50  
19.5 cm / 7 $\frac{3}{4}$ "

**Nasal Rasps**

Рашпили назальные

# Professional

Нож для микрохирургии уха DINGMAN, 15 см

Рашпиль носовой LEWIS

Нож для микрохирургии уха KISTLER ANTHELIX, обратнорежущий, с 2-мя рядами зубьев, S-изогнутый

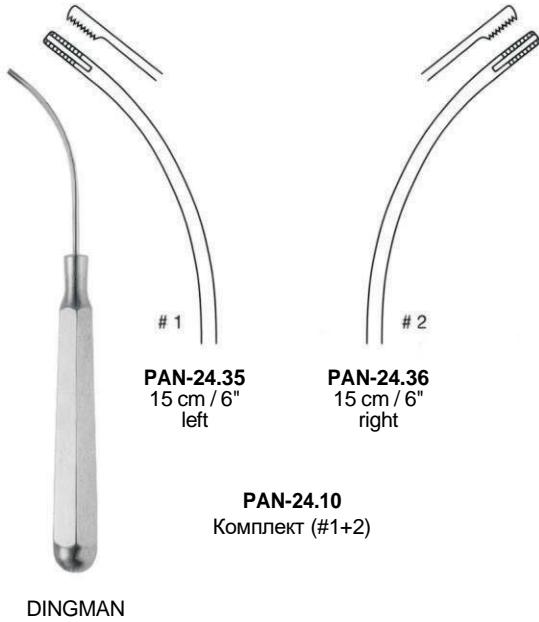

**PAN-24.35**  
15 cm / 6"  
left

**PAN-24.36**  
15 cm / 6"  
right

**PAN-24.10**  
Комплект (#1+2)

DINGMAN



LEWIS  
**PAN-24.26**  
20 cm / 8"

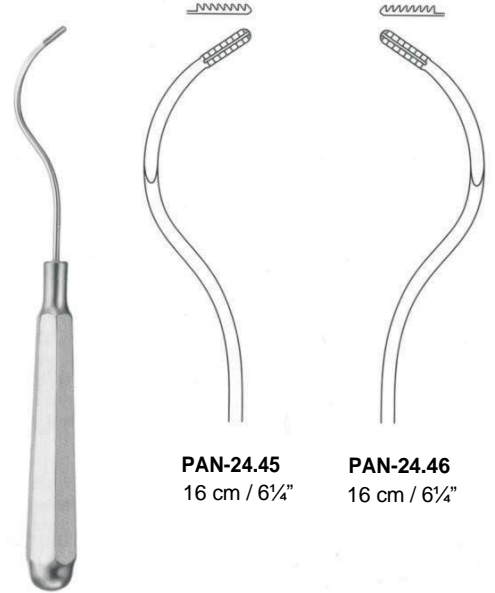

**PAN-24.45**  
16 cm / 6¼"

**PAN-24.46**  
16 cm / 6¼"

KISTLER

Ручка для сменных назальных рашпелей "НМ", 14см

Ключ для крепления сменных назальных рашпелей к ручке



**PAN-25.00**  
14 cm / 5½"

**PAN-25.01**  
14 cm / 5½"



**PAN-25.81**  
Fig. 1



**PAN-25.82**  
Fig. 2



**PAN-25.83**  
Fig. 3



**PAN-25.84**  
Fig. 4



**PAN-25.85**  
Fig. 5

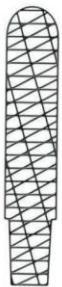

**PAN-25.86**  
Fig. 6



**PAN-25.87**  
Fig. 7

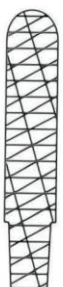

**PAN-25.88**  
Fig. 8



**PAN-25.89**  
Fig. 9



**PAN-25.90**  
Fig. 10

Сменные назальные рашпили из карбида вольфрама



WRENCH  
**PAN-25.03**

Рашпиль носовой  
AUFRICHT, 21 см



AUFRICHT

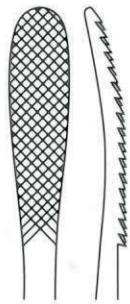

PAN-25.26  
21 cm / 8¼"

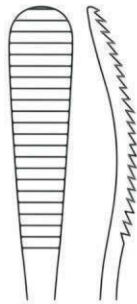

PAN-25.27  
21 cm / 8¼"

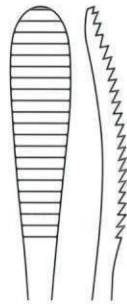

PAN-25.28  
21 cm / 8¼"

Рашпиль  
носовой  
двухсторонний  
FOMON, 20 см



FOMON  
PAN-25.32  
22 cm / 8¾"

деликатный  
fine

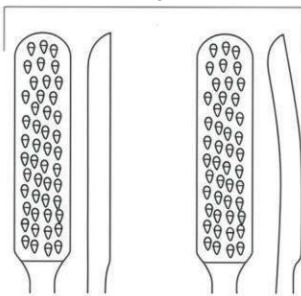

PAN-25.41

PAN-25.43

полуделикатный  
semi fine

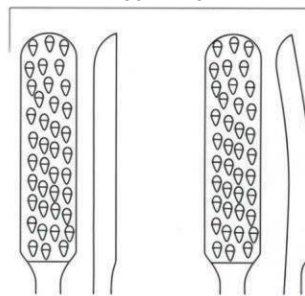

PAN-25.42

PAN-25.44

fine

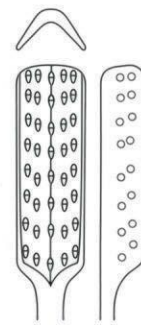

PAN-25.45

semi fine

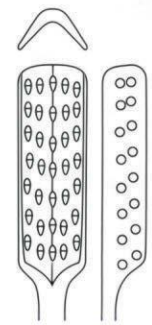

PAN-25.46

Рашпиль носовой двухсторонний OBWEGESER, прямой,  
прямо/обратнорезающий, 19,5 см



OBWEGESER  
19 cm / 7¾"



OBWEGESER  
19 cm / 7¾"

Рашпиль носовой двухсторонний  
CONVERSE, тонкий/грубый,  
перекрестная насечка, 18.5 см

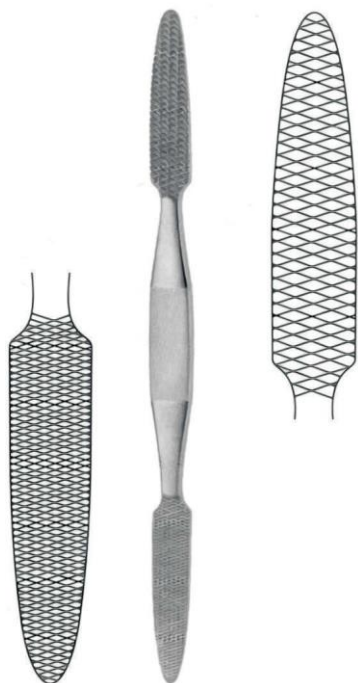

CONVERSE  
PAN-25.65  
18.5 cm / 7 1/4"

Рашпиль  
носовой  
двухсторонний  
MASING,  
деликатный, 21  
см

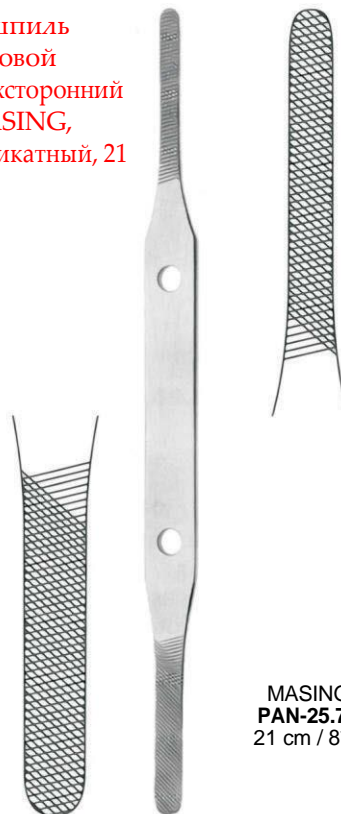

MASING  
PAN-25.70  
21 cm / 8 1/4"

Рашпиль  
носовой  
двухсторонний  
MASING,  
грубый, 21 см



MASING  
PAN-25.71  
21 cm / 8 1/4"

Рашпиль носовой  
двухсторонний  
GUBISCH  
FOMON, тип T/C  
р/ч из карбида  
вольфрама, 20см



GUBISCH FOMON  
PAN-26.30  
20 cm / 8"

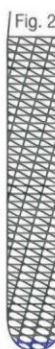



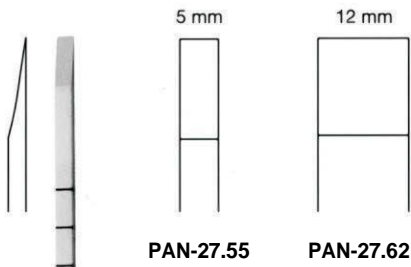

Долото COTTLE GUBISCH, плоское, градуированное, прямое, 18 см

COTTLE GUBISCH  
18 cm / 7 1/8"

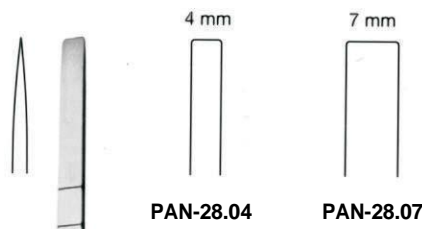

Остеотом COTTLE, плоский, градуированный, прямой, 18 см

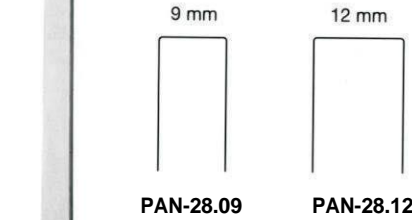

COTTLE  
18 cm / 7 1/8"

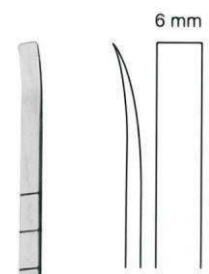

Остеотом COTTLE, плоский, изогнутый, градуированный, для боковой остеотомии, 6 мм, 18 см

COTTLE PAN-28.16  
18 cm / 7 1/4"

Крестовидный остеотом COTTLE, плоский, лезвие "рыбий хвост", градуированный, 16 мм, 18 см

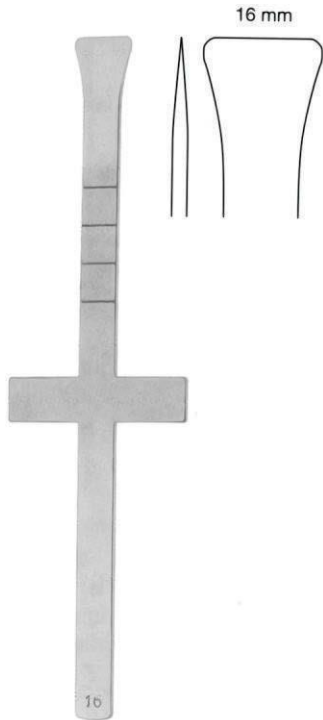

COTTLE PAN-28.20  
18 cm / 7 1/8"

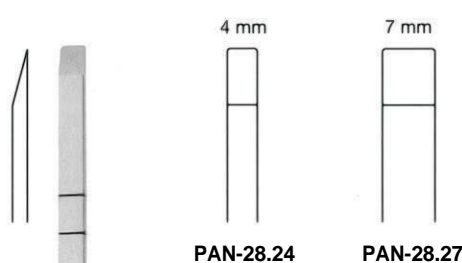

COTTLE  
18 cm / 7 1/8"

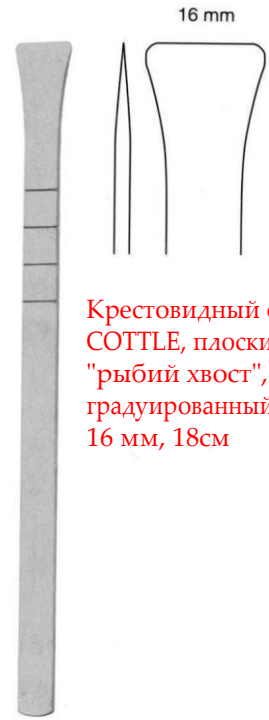

Крестовидный остеотом COTTLE, плоский, лезвие "рыбий хвост", градуированный, прямой, 16 мм, 18 см

COTTLE PAN-28.38  
18 cm / 7 1/8"

Osteotomes

Долота хирургические, остеотомы

# Professional

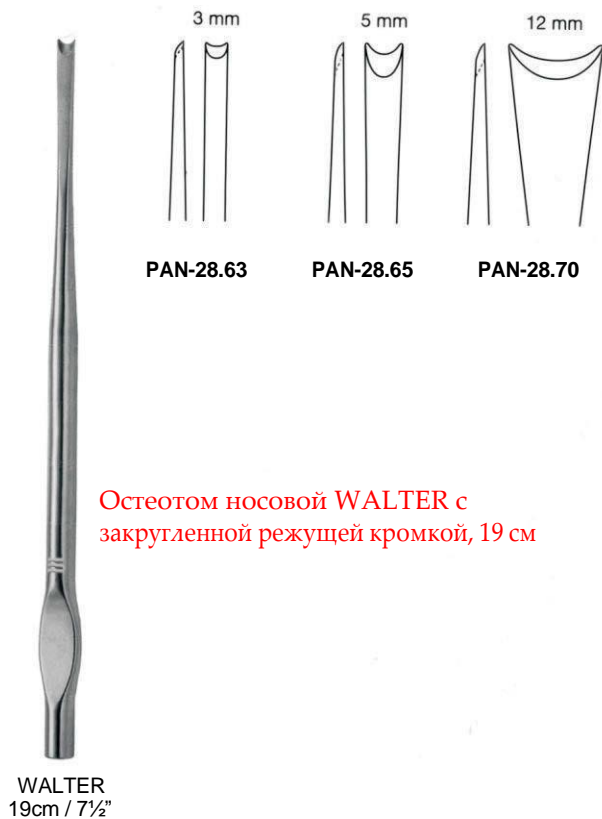

Остеотом носовой WALTER,  
19 см

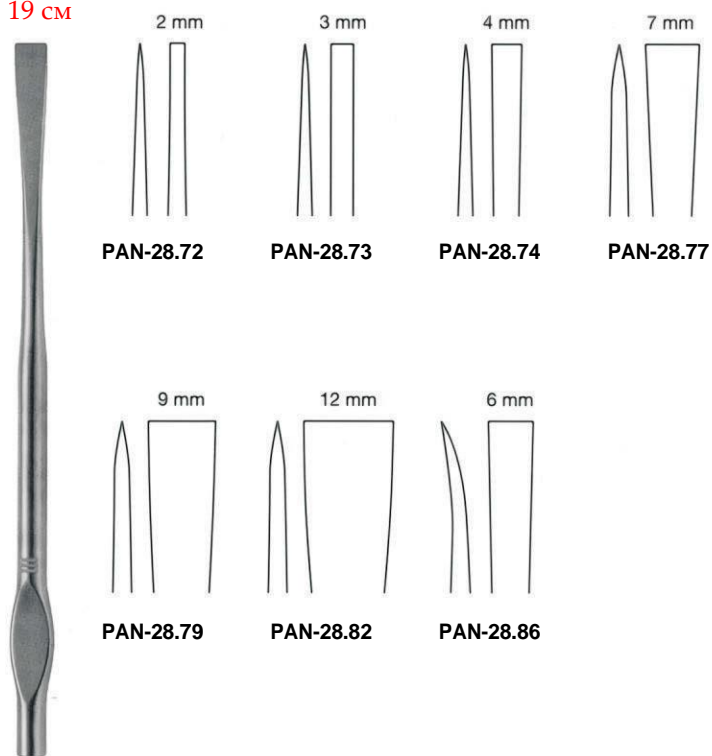

WALTER  
19cm / 7½"

Остеотом носовой SCHROM, лезвие желобчатое,  
с направляющим шипом, 3 мм, 19.5 см

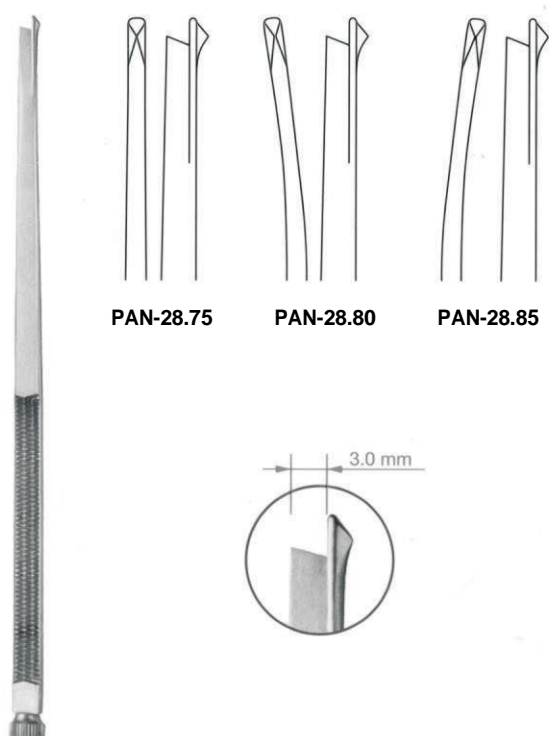

SCHROM  
19.5 cm / 7¾"



Septum Forceps

Щипцы для операций на носовой перегородке

Professional

изогнуты по оси



ASCH  
PAN-29.21  
22 cm / 8<sup>3</sup>/<sub>4</sub>"

разборные



COTTLE FOMON  
PAN-30.24  
21 cm / 8<sup>1</sup>/<sub>4</sub>"

прямые, правые

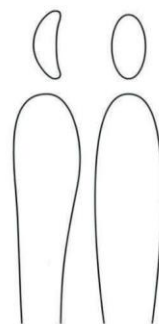

PAN-30.22  
23 cm / 9"

прямые, левые

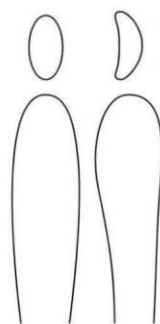

PAN-30.23  
23 cm / 9"

универсальные



WALSHAM "UNIVERSAL"  
PAN-30.21  
23 cm / 9"



WALSHAM

Щипцы для операций на носовой перегородке  
OBWEGESER, бранши режущие, изогнуты по  
плоскости, 18.5 см

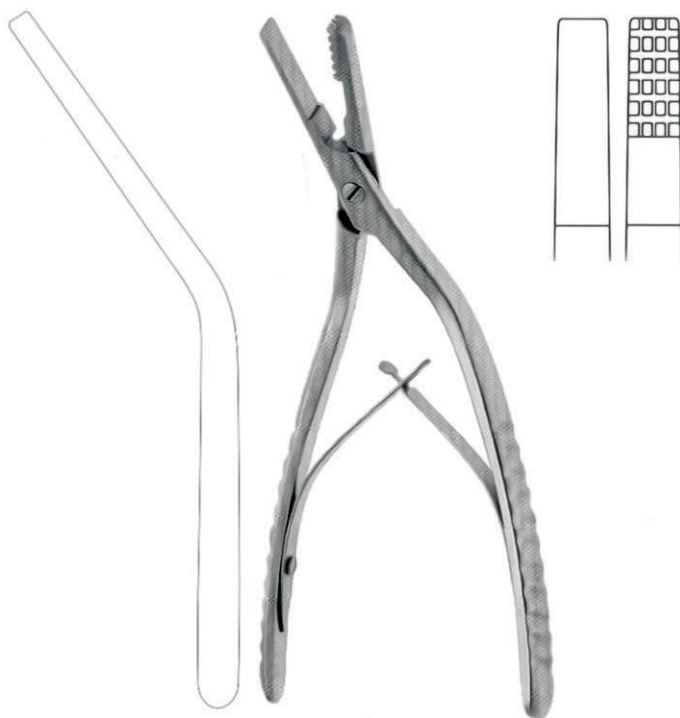

OBWEGESER  
PAN-29.23  
18.5 cm / 7 1/4"

Щипцы для операций на носовой  
перегородке OBWEGESER ложечные,  
перфорационные, с овальным  
концом, 4 мм, 18.5 см



OBWEGESER  
PAN-30.34  
21 cm / 8 1/4"

Щипцы для операций на носовой перегородке OBWEGESER, тупоконечные, костные, с одной зазубренной вогнутой браншей, 17.5 см

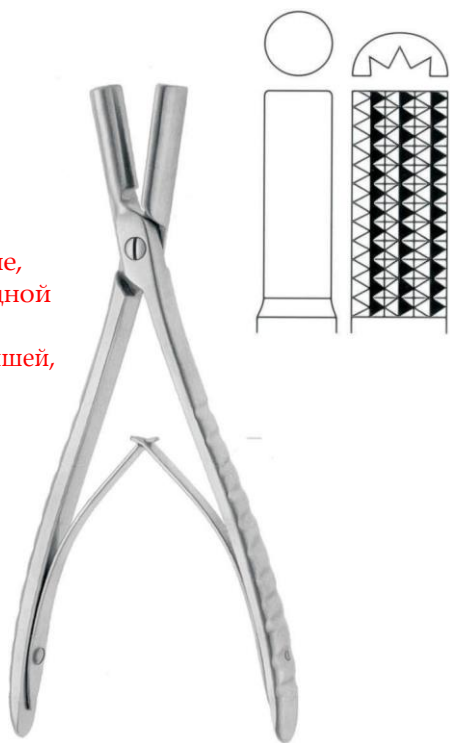

OBWEGESER  
PAN-29.35  
17.5 cm / 7"

Щипцы для операций на носовой перегородке OBWEGESER, тупоконечные, костные, с одной зазубренной выпуклой браншей, 17.5 см

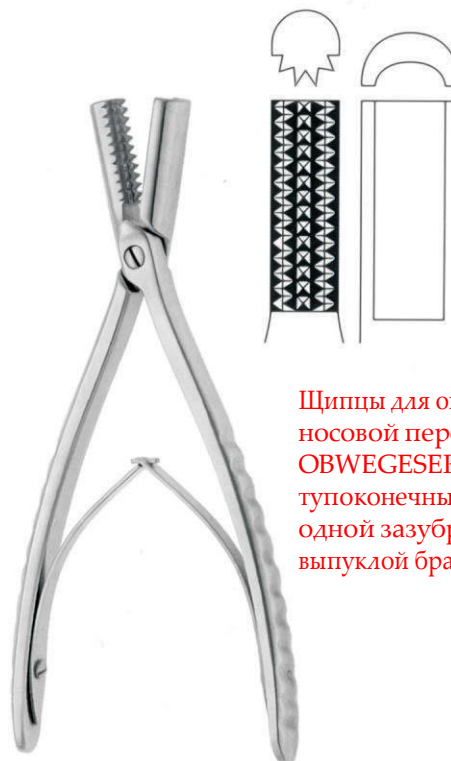

OBWEGESER  
PAN-29.36  
17.5 cm / 7"

Щипцы для операций на носовой перегородке RUBIN, тупоконечные, костные, с тонко зазубренными браншами, защитным колпачком, 20 см

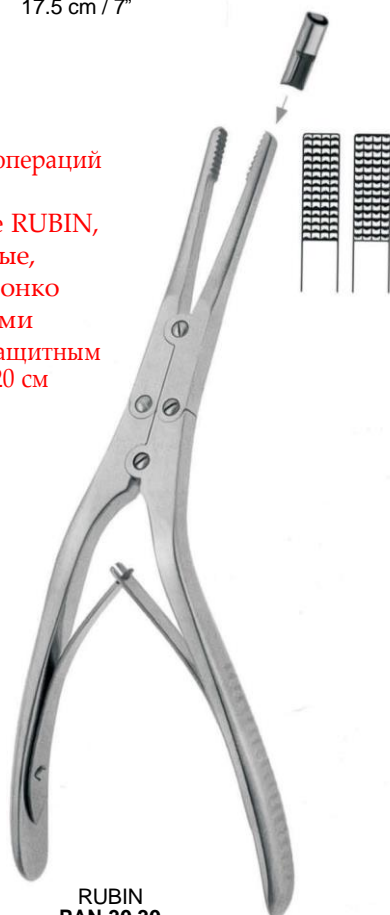

RUBIN  
PAN-30.30  
20 cm / 8"

Щипцы для операций на носовой перегородке RUBIN, тип Т/С, р/ч из карбида вольфрама, концы овальные, с тонко зазубренными браншами, защитным колпачком, 20 см



RUBIN  
PAN-30.72  
20 cm / 8"

Распатор  
OBWEGESER  
изогнутый



OBWEGESER

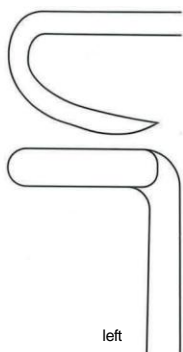

left

PAN-30.65  
30 cm / 11¼"

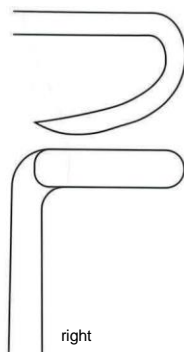

right

PAN-30.66  
30 cm / 11¼"

Распатор  
отсасывающий,  
градуированный,  
диам. 4 мм, 20 см



PAN-33.93  
20 cm / 8"



4 mm



Распатор отсасывающий GUBISCH,  
градуированный, с байпасом



GUBISCH  
PAN-33.94  
20 cm / 8"

4 mm

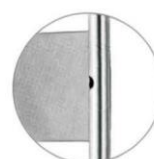

Bypass



GUBISCH  
PAN-33.97  
17cm / 6¾"

4 mm



Raspatories

Распаторы, элеваторы

# Professional

Элеватор / распатор COTTLE

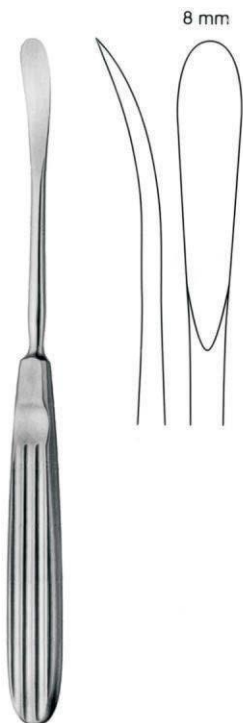

COTTLE  
PAN-31.19  
18 cm / 7 1/8"

Элеватор COTTLE



COTTLE  
PAN-31.20  
18 cm / 7 1/8"

4 mm



Распатор  
назальный  
JOSEPH-  
MASING

JOSEPH MASING  
PAN-31.48  
22 cm / 8 3/4"

Элеватор YANKAUER, тупой



PAN-31.55  
18 cm / 7 1/8"



Элеватор для  
эндоназального  
вправления  
костей носа

PAN-31.60  
17 cm / 6 3/4"



Распатор  
периостальный  
CONVERSE

CONVERSE  
PAN-31.65  
18 cm / 7 1/8"

8 mm



Элеватор  
назальный  
BOIES

BOIES  
PAN-31.69  
19 cm / 7 1/2"

5 mm



Элеватор  
(вытеснитель носовой  
перегородки)  
GOLDMAN

GOLDMAN  
PAN-31.75  
17 cm / 6 3/4"

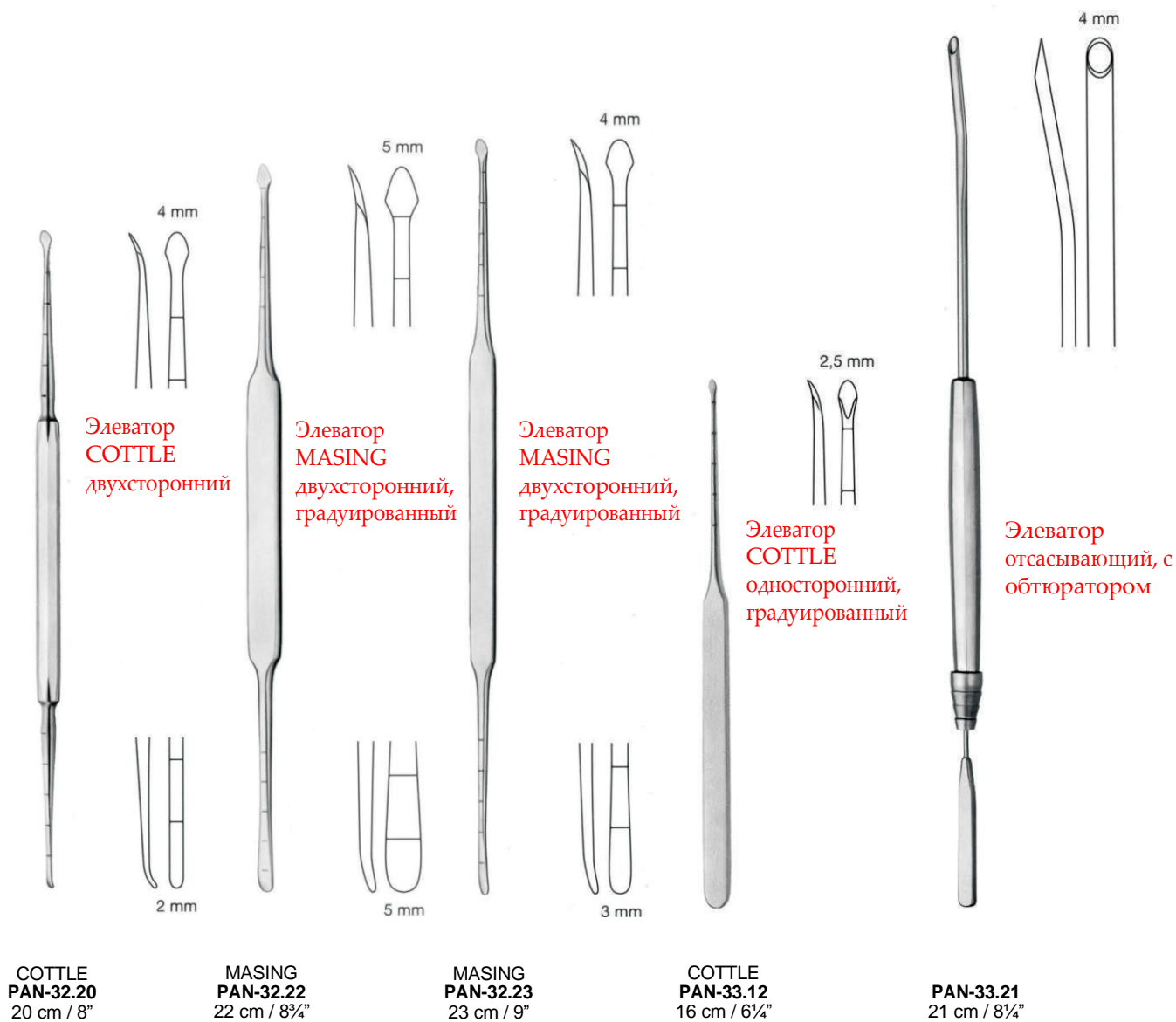

Элеватор COTTLE-McKENTY  
двухсторонний, р/ч 4/4 мм, 22 см



COTTLE-  
MCKENTY  
PAN-34.22  
22 cm / 8<sup>3</sup>/<sub>4</sub>"

Распатор носовой  
COTTLE двухсторонний,  
р/ч 4/4 мм, 23 см



COTTLE  
PAN-34.23  
22 cm / 9"

Распатор COTTLE комбинированный,  
двухсторонний, 23 см



COTTLE  
PAN-34.24  
23 cm / 9"

Долото McINDOE, кромка лезвия вогнутая

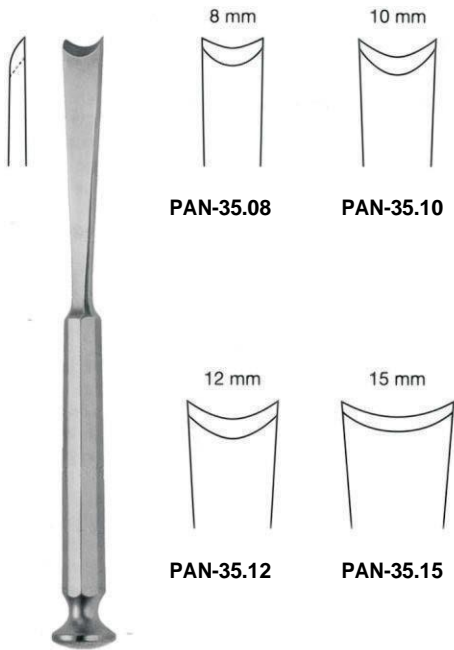

MCINDOE  
16 cm / 6 1/4"

Долото MOBERG, с зондирующими выступами по обеим сторонам

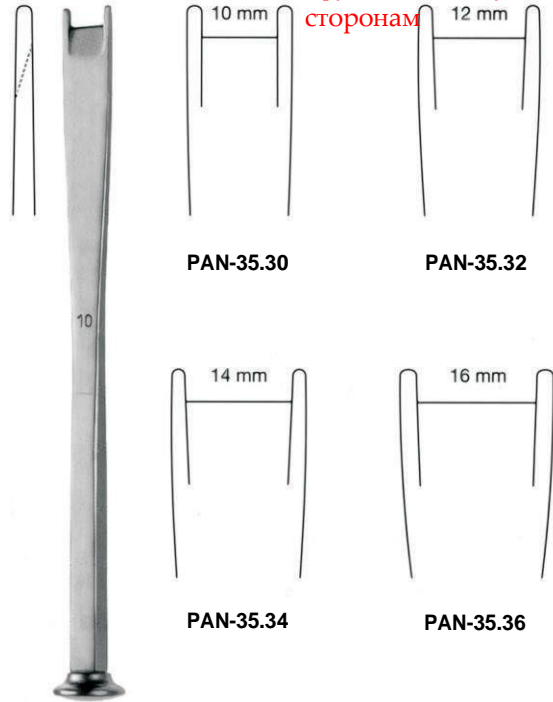

MOBERG  
18 cm / 7 1/8"

Долото RUBIN Т-образное, рабочая часть имеет боковые кромки

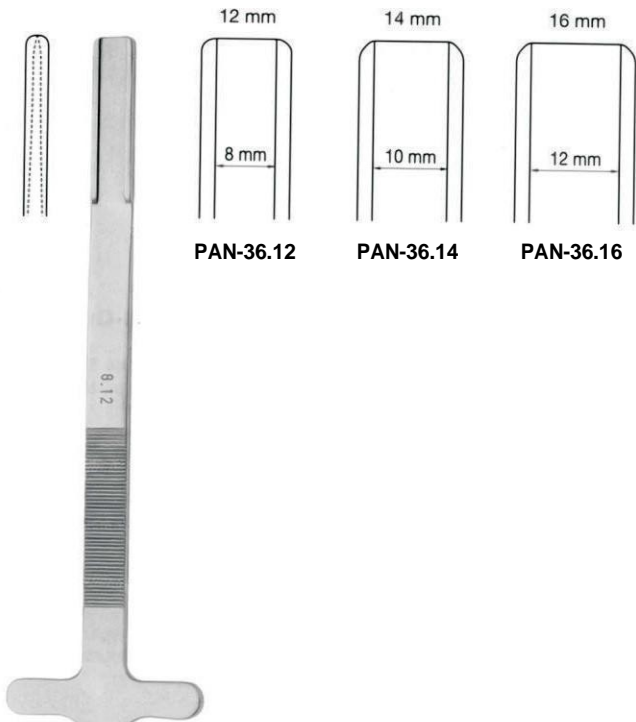

RUBIN  
19 cm / 7 1/2"

Элеватор / распатор для надкостницы OBWEGESER

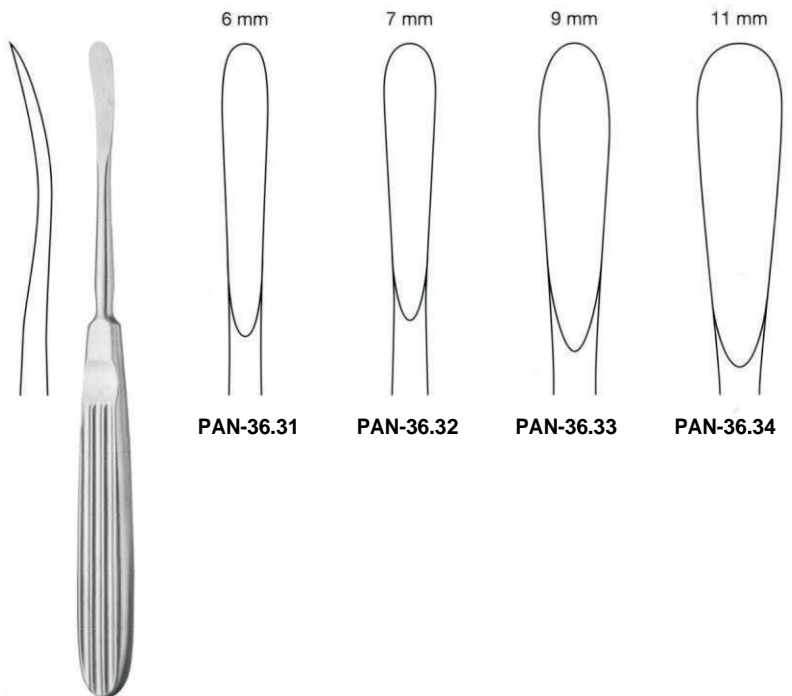

OBWEGESER  
17.5 cm / 7"



Распатор Hargis,  
изогнутый, р/ч 9 мм, 19 см



HARGIS  
PAN-36.35  
19 cm / 7½"  
2050 р



OBWEGESER  
18 cm / 7 1/8"

Распатор для  
нижнечелюстного  
сустава OBWEGESER,  
изогнутый



PAN-36.36



PAN-36.37



OBWEGESER  
PAN-36.38  
17.5 cm / 7"

Периостальный  
элеватор / распатор  
OBWEGESER,  
рабочая часть слегка  
изогнута, рабочий  
край V-образный,  
острый, ширина 9 мм,  
17.5 см

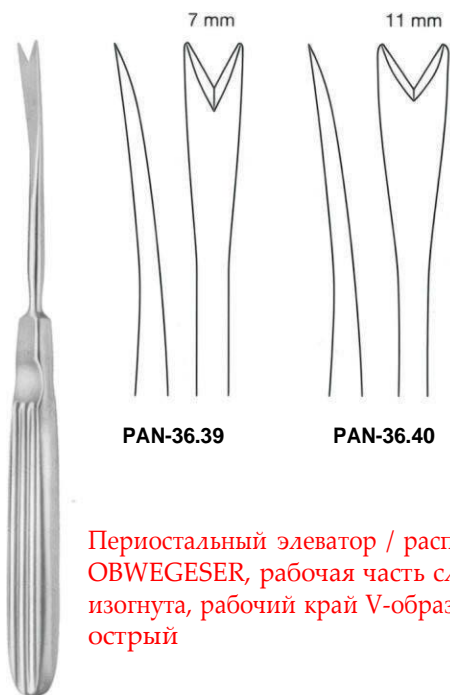

PAN-36.39

PAN-36.40

OBWEGESER  
17.5 cm / 7"

Периостальный элеватор / распатор  
OBWEGESER, рабочая часть слегка  
изогнута, рабочий край V-образный,  
острый



PAN-36.41

PAN-36.42

PAN-36.43

OBWEGESER  
20 cm / 8"

Периостальный элеватор / распатор OBWEGESER,  
рабочая часть изогнута крючком

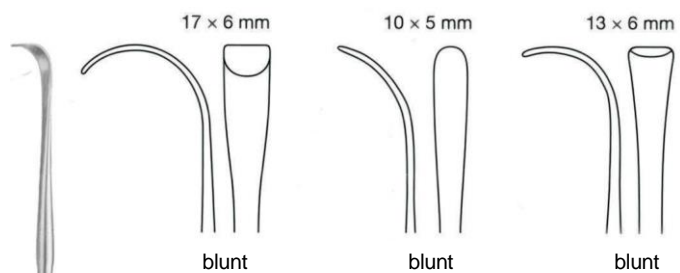

Периостальный элеватор / распатор OBWEGESER  
FREER двухсторонний, остро/тупоконечный

PAN-36.50

PAN-36.51

PAN-36.52

OBWEGESER  
FREER  
21 cm / 8 1/4"

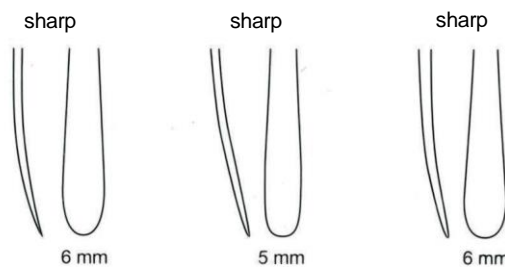

Распатор Dingman  
двухсторонний,  
остро / тупо конечный

DINGMAN  
PAN-37.18  
18 cm / 7 1/8"

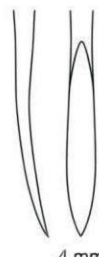

Элеватор / распатор  
Steinhauser Orbital  
Floor,  
односторонний,  
рабочая часть  
изогнута крючком

STEINHAUSE  
PAN-37.25  
17 cm / 6 3/4"

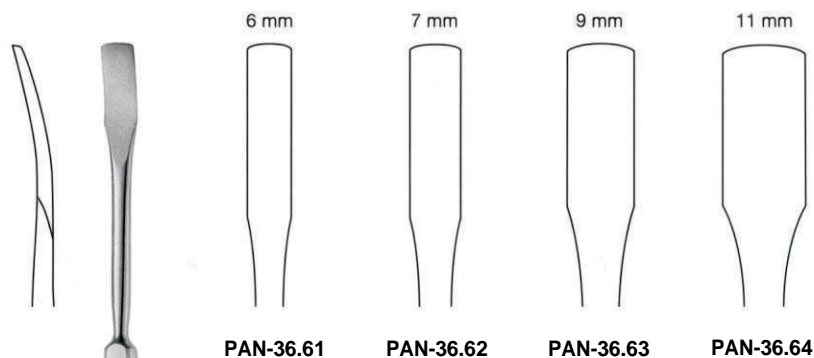

Периостальный элеватор  
OBWEGESER, односторонний,  
слегка изогнутый, рабочая кромка  
скошена

OBWEGESER  
18 cm / 7 1/8"

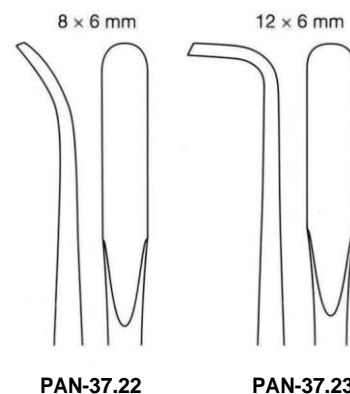

Распатор TESSIER, односторонний,  
рабочая часть изогнута

TESSIER  
18 cm / 7 1/8"

## Chisels

Долота, остеотомы

# Professional

Остеотом FOMON с левым ограничителем



FOMON

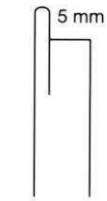

PAN-38.17  
17 cm / 6 3/4"

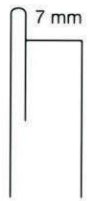

PAN-38.19  
17 cm / 6 3/4"



PAN-38.20  
17 cm / 6 3/4"



SILVER  
18 cm / 7 1/8"

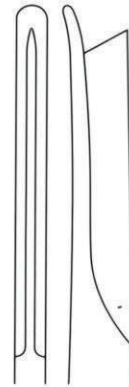

PAN-40.01

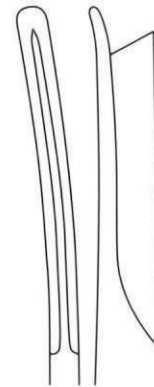

PAN-40.02

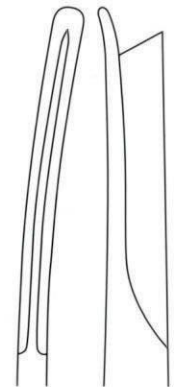

PAN-40.03

Остеотом SILVER, режущая кромка скошена, с тупым правым сферическим боковым выступом

Остеотом CINELLI с ограничителем с двух сторон



CINELLI  
16 cm / 6 1/4"

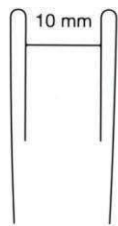

PAN-39.10



PAN-39.12

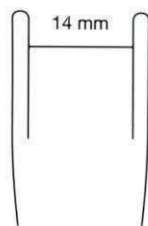

PAN-39.14

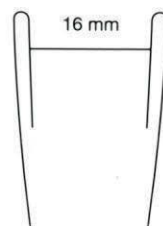

PAN-39.16



BLUME  
PAN-40.20  
18 cm / 7 1/8"

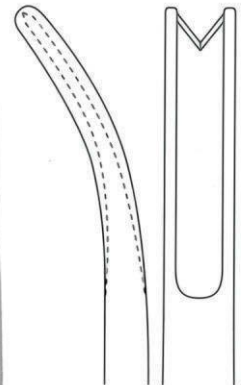

Остеотом BLUME изогнутый, лезвие с ограничителем с двух сторон, V-образный кончик, 6 мм, 18 см



Остеотом  
GUBISCH с  
алюминиево  
й рукояткой, 3  
мм, 18.5 см

GUBISCH  
PAN-40.53  
18.5 cm / 7¼"

Остеотом OBWEGESER

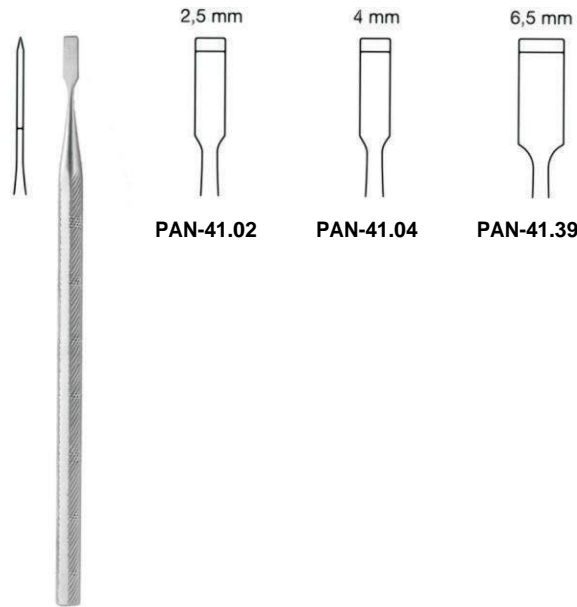

2,5 mm  
PAN-41.02

4 mm  
PAN-41.04

6,5 mm  
PAN-41.39

OBWEGESER  
15 cm / 6"



a = 8 mm PAN-41.12  
a = 12 mm PAN-41.13  
a = 16 mm PAN-41.14

Остеотом Obwegeser, р/ч  
клиновидной формы, 22 см, с  
автоклавируемой пластиковой  
рукояткой

OBWEGESER  
22 cm / 8¾"



7 mm  
PAN-41.07

10 mm  
PAN-41.10

Остеотом Obwegeser, лезвие  
клиновидной формы, 21.5 см, с  
автоклавируемой пластиковой  
рукояткой

OBWEGESER  
21.5 cm / 8½"



a = 8 mm PAN-41.16  
a = 12 mm PAN-41.17  
a = 16 mm PAN-41.18  
a = 20 mm PAN-41.20

Остеотом Obwegeser, лезвие  
клиновидной формы, 22 см, с  
автоклавируемой пластиковой  
рукояткой

OBWEGESER  
22 cm / 8¾"

Osteotomes

Долота, остеотомы

# Professional



Остеотом  
OBWEGESER  
изогнутый, 10  
мм, 23.5 см

OBWEGESER  
PAN-41.30  
23.5 cm / 9¼"



Остеотом OBWEGESER  
изогнутый, с гибким  
лезвием, 21см

OBWEGESER  
21 cm / 8¼"



Остеотом TESSIER, прямой,  
лезвие "рыбий хвост", 20.5 см

TESSIER  
20.5 cm / 8"



Остеотом TESSIER,  
изогнутый, лезвие "рыбий  
хвост", 20.5 см

TESSIER  
20.5 cm / 8"

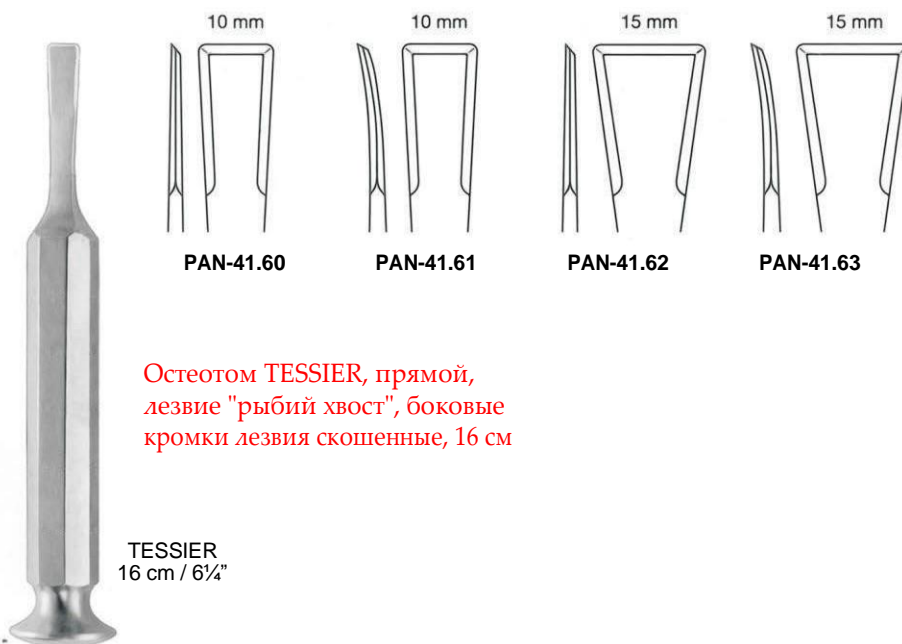

Остеотом TESSIER, прямой,  
лезвие "рыбий хвост", боковые  
кромки лезвия скошенные, 16 см

TESSIER  
16 cm / 6¼"



Остеотом  
OBWEGESER для  
мобилизации верхней  
челюсти, 23 см

OBWEGESER  
PAN-42.29  
11 cm / 9"

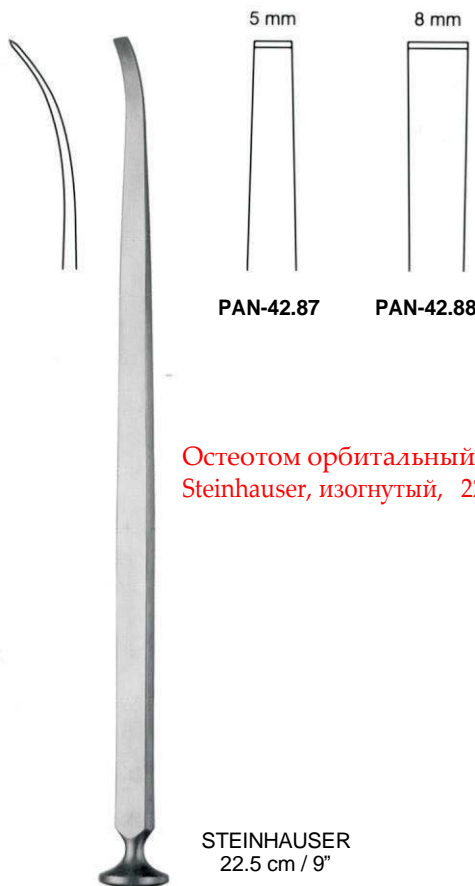

Остеотом орбитальный  
Steinhauser, изогнутый, 22.5 см

STEINHAUSER  
22.5 cm / 9"

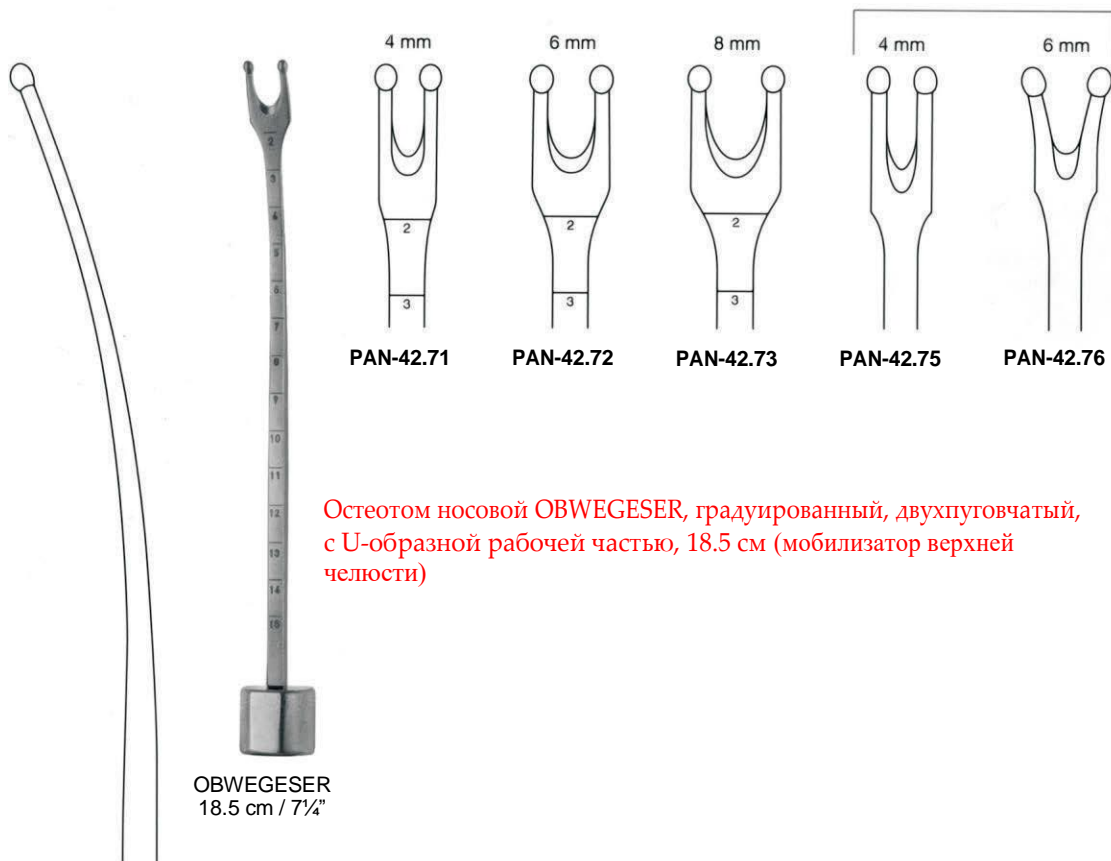

Остеотом носовой OBWEGESER, градуированный, двухпугочатый,  
с U-образной рабочей частью, 18.5 см (мобилизатор верхней  
челюсти)

OBWEGESER  
18.5 cm / 7 1/4"

Выкусыватель по SHEPARD,  
диаметр 12 мм, длина 12 см

Ø 12 mm



SHEPARD  
PAN-42.02  
12 cm / 4 3/4"

Ручка по SHEPRAD, для  
вкручивания  
цилиндрического  
остеотома, 11 см



SHEPARD  
PAN-42.11  
11 cm / 4 3/8"

Цилиндрический остеотом Shepard, 12.5 см



Ø = 5 mm PAN-42.05  
Ø = 6 mm PAN-42.06  
Ø = 8 mm PAN-42.08

12.5 cm / 5"

Проталкиватель для  
цилиндрического  
остеотома Shepard, 14 см



14 cm / 5 1/2"  
PAN-42.12  
PAN-42.13  
PAN-42.14

Троакар для  
цилиндрического  
остеотома Shepard, 14.5 см



14.5 cm / 5 3/4"  
PAN-42.15  
PAN-42.16  
PAN-42.18

SHEPARD



Костная мельница механическая, в сборе, диаметр 65x110 мм

Костная мельница COTTLE для ручной подготовки собственного костного трансплантата, 65x30 мм

65 x 30 x 30 mm



COTTLE  
PAN-34.70



PAN-34.75  
Ø 68 x 110 mm

Костная мельница GUBISCH для ручной подготовки собственного костного трансплантата, 65x30 мм

65 x 30 mm

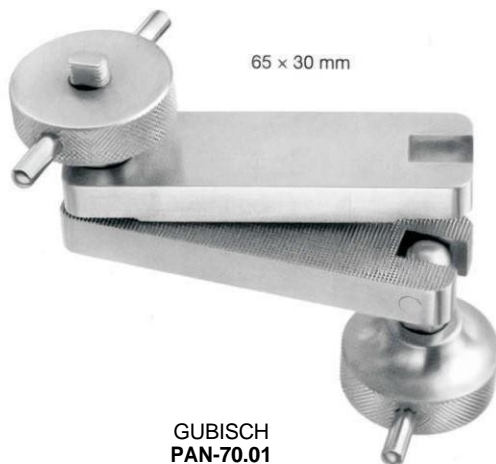

GUBISCH  
PAN-70.01

Пластина для резки костного материала, тефлон, 85x55x10 мм

85 x 55 x 10 mm



PAN-70.75



Инструмент для расширения запястного канала

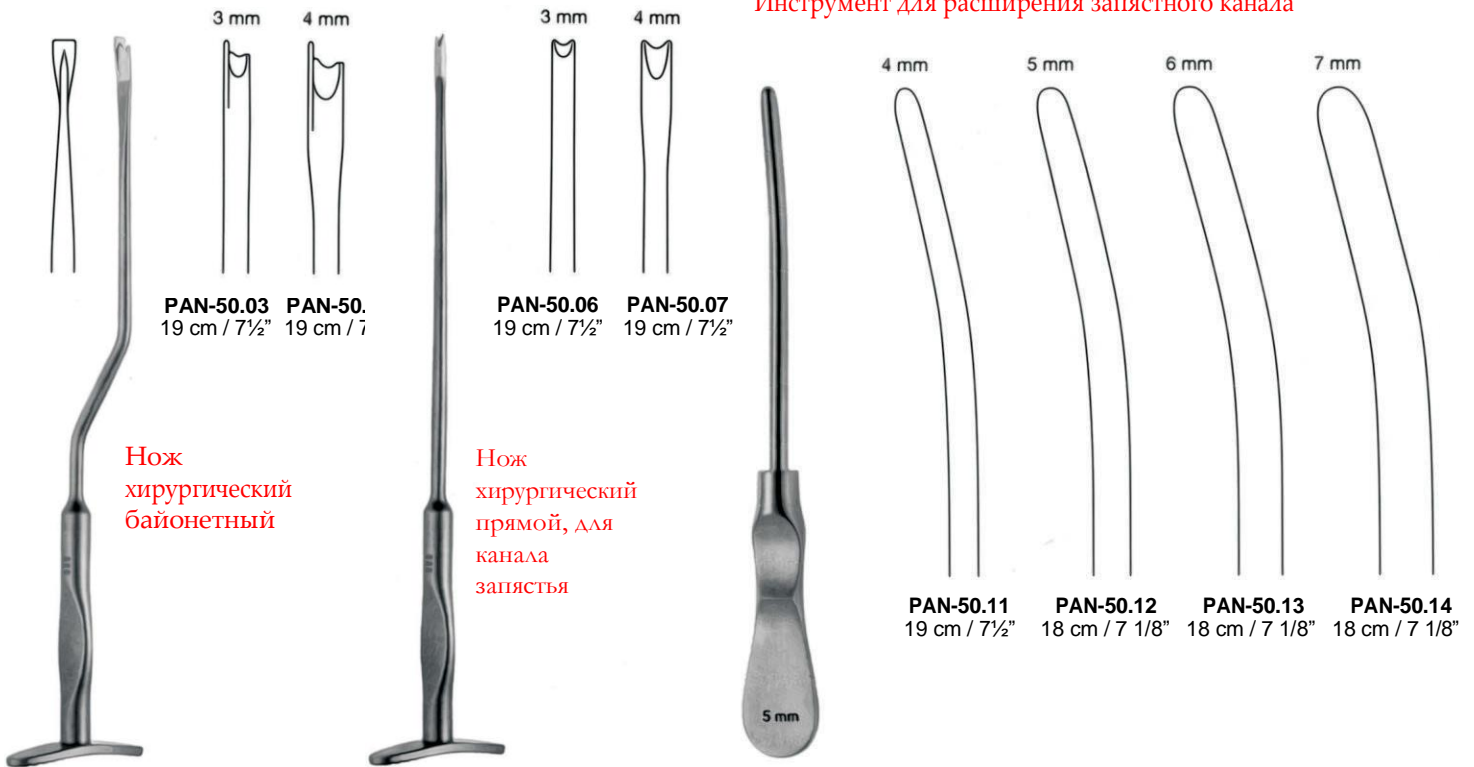

Нож хирургический байонетный

Нож хирургический прямой, для канала запястья

Handle  
Mango  
Manche  
Manico

Рукоятка для инструмента HERMANN для канала запястья

Сменный нож для инструмента HERMANN, прямой, для канала запястья

PAN-50.10  
13 cm / 5 1/8"

### Распаторы и диссекторы для эндоскопического фейслифтинга

Распатор для эндоскопического фейслифтинга, изогнутый, р/ч 6 мм, 25 см, автоклавируемый

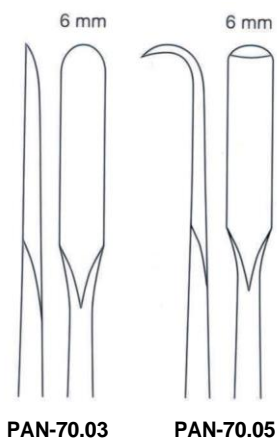

PAN-70.03

PAN-70.05

Распатор для эндоскопического фейслифтинга, прямой, р/ч 6 мм, 25 см, автоклавируемый



25 cm / 10"



PAN-70.04

PAN-70.06



25 cm / 10"

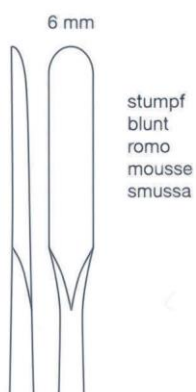

stumpf  
blunt  
romo  
mousse  
smussa



PAN-70.08  
25 cm / 10"

Диссектор для эндоскопического фейслифтинга, прямой, р/ч 6 мм притуплена, 25 см, автоклавируемый

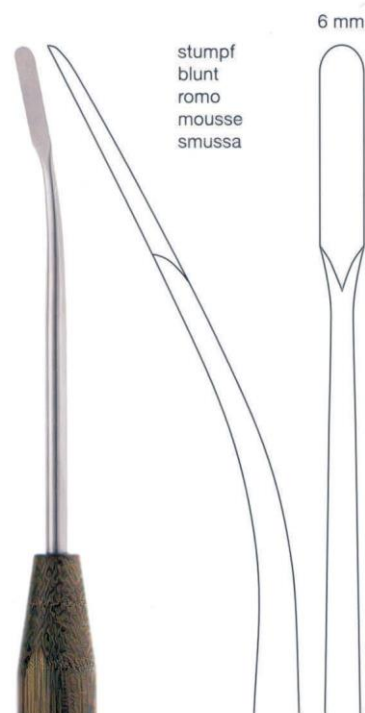

stumpf  
blunt  
romo  
mousse  
smussa



PAN-70.09  
25 cm / 10"

Диссектор для эндоскопического фейслифтинга, изогнутый, р/ч 6 мм притуплена, 25 см, автоклавируемый

Крючок хирургический для эндоскопического фейслифтинга, изогнутый, 20 см

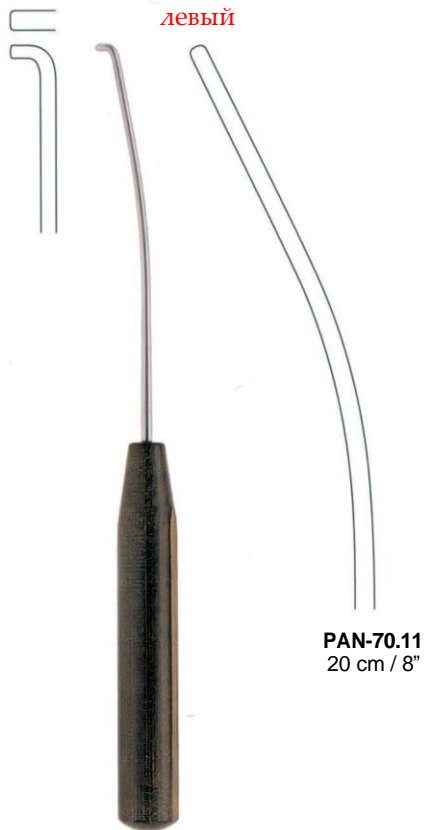

левый

PAN-70.11  
20 cm / 8"

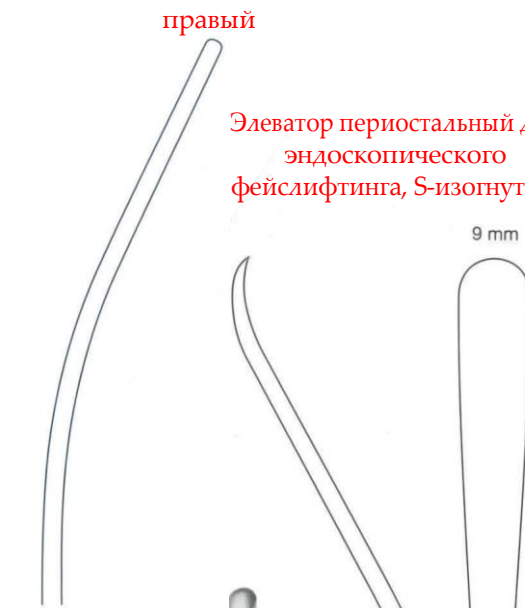

правый

PAN-70.12  
20 cm / 8"

Элеватор периостальный для эндоскопического фейслифтинга, S-изогнутый

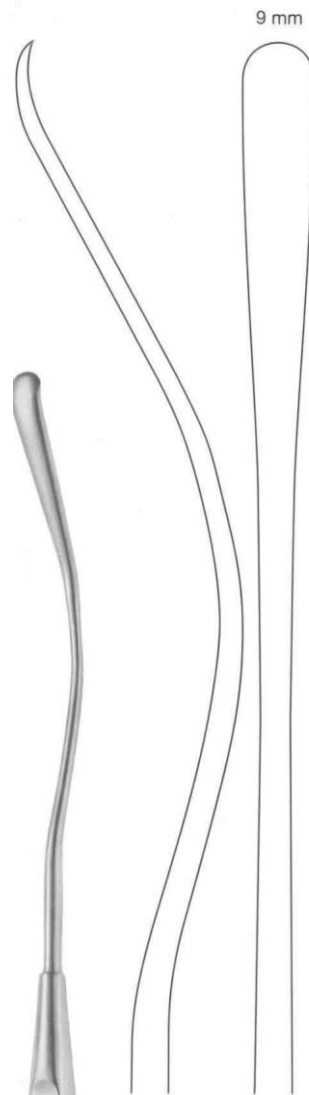

9 mm

Диссектор для эндоскопического фейслифтинга, бранша слегка изогнута, 11 мм, 27.5 см



9 mm

Игла лигатурная ENTNER

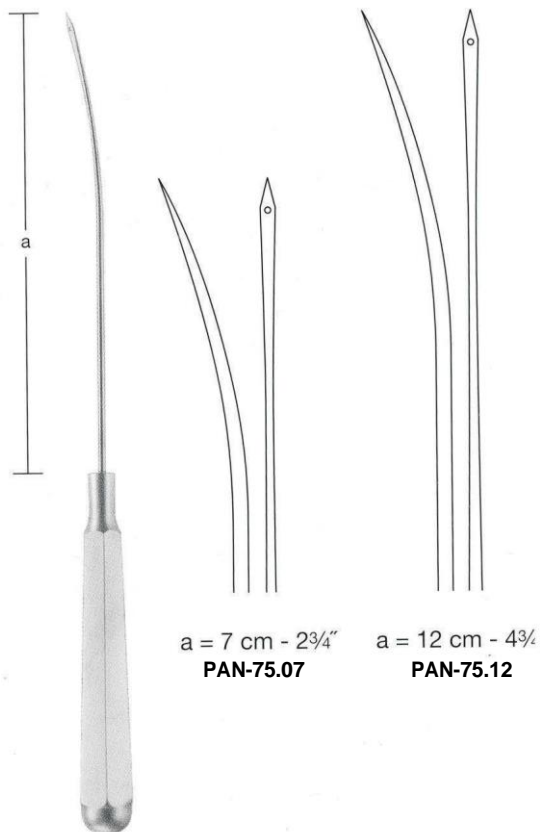

a = 7 cm - 2<sup>3</sup>/<sub>4</sub>"  
PAN-75.07

a = 12 cm - 4<sup>3</sup>/<sub>4</sub>"  
PAN-75.12

PAN-70.43  
27 cm / 10"

PAN-70.45  
27.5 cm / 10<sup>3</sup>/<sub>4</sub>"

Элеватор для эндоскопического фейслифтинга, прямой

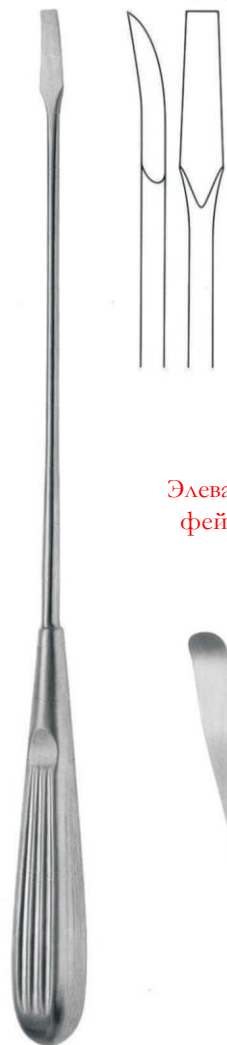

PAN-70.47  
27.5 cm / 10<sup>3</sup>/<sub>4</sub>"

Элеватор для эндоскопического фейслифтинга, конец слегка изогнут

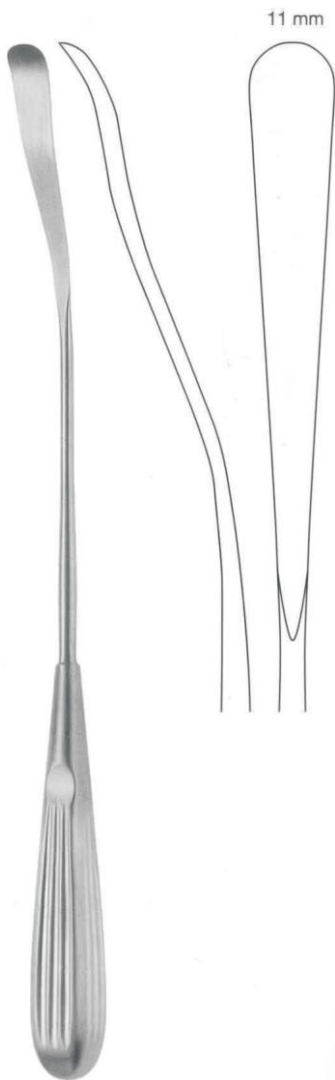

PAN-70.49  
27.5 cm / 10<sup>3</sup>/<sub>4</sub>"

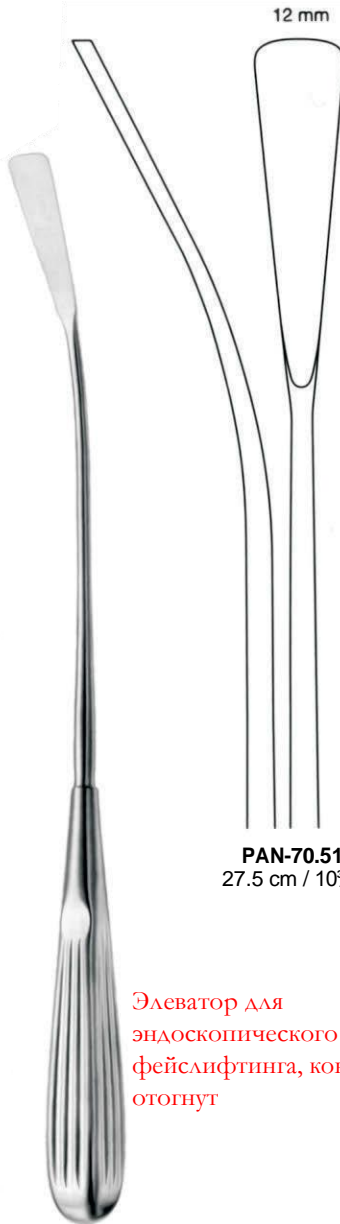

PAN-70.51  
27.5 cm / 10<sup>3</sup>/<sub>4</sub>"

Элеватор для эндоскопического фейслифтинга, конец слегка отогнут

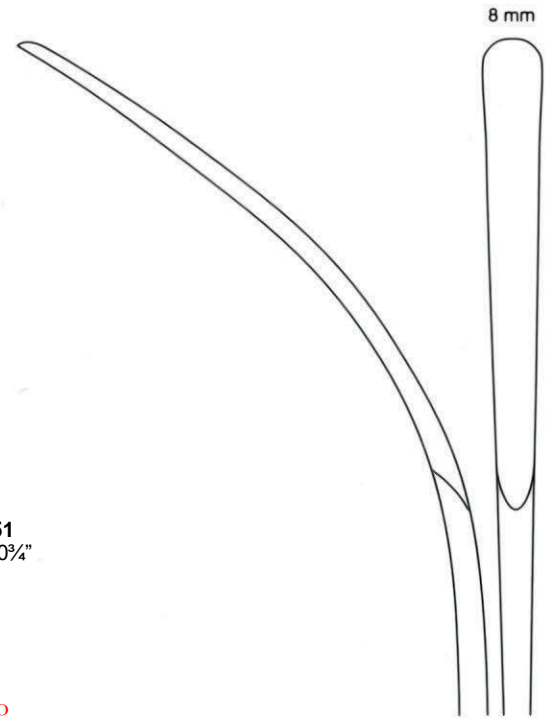

PAN-70.53  
25.5 cm / 10"

Элеватор для эндоскопического  
фейслифтинга, прямой, р/ч 8 мм, 28 см



**PAN-70.54**  
28 cm / 11"

Элеватор для эндоскопического  
фейслифтинга, конец слегка изогнут,  
р/ч 8 мм, 27 см

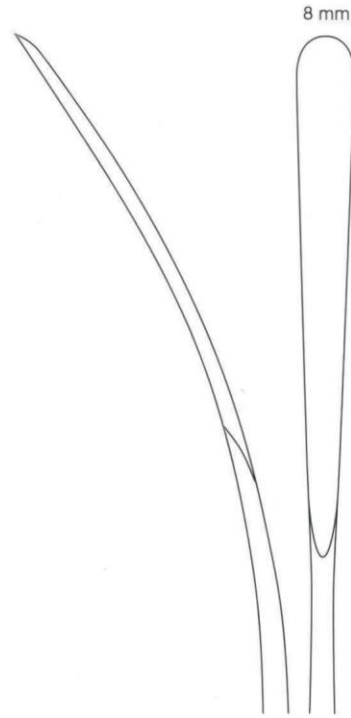

**PAN-70.55**  
27 cm / 10¾"

Отсасывающий элеватор для  
эндоскопического  
фейслифтинга, р/ч 7 мм, 27.5 см



**PAN-70.59**  
27.5 cm / 10¾"

Элеватор для эндоскопического  
фейслифтинга, конец сильно  
изогнут, р/ч 8 мм, 24 см



**PAN-70.57**  
24 cm / 9½"

#### Ножницы эндоскопические для фейслифтинга, изогнутые

Hook scissors  
Tijeras de gancho  
Ciseaux à crochet  
Forbici a gancio



изогнутые влево

изогнутые вправо

curved left  
curva izquierdo  
courbes à gauche  
curva sinistra

curved right  
curva derecho  
courbes à droite  
curva destra



PAN-70.15

PAN-70.16

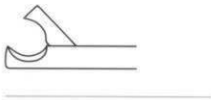

#### Щипцы захватывающие зубчатые для эндоскопического фейслифтинга

Grasping forceps  
Pinzas para agarrar  
Pinces à saisir  
Pinze per afferrare



изогнутые влево

изогнутые вправо

curved left  
curva izquierdo  
courbes à gauche  
curva sinistra

curved right  
curva derecho  
courbes à droite  
curva destra



PAN-70.17

PAN-70.18



## Lip and Cleft Palate Instruments

Элеваторы и распаторы для палатосхизиса  
(расщелина нёба, волчья пасть)

# Professional

Крючок для уранопластики BLOCKSMA,  
изогнутый, однозубый, 18 см

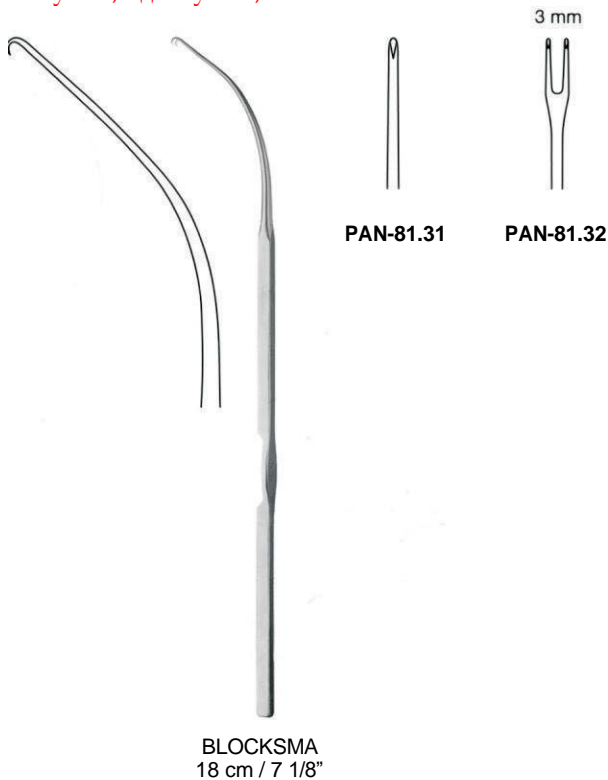

Распатор для уранопластики, 14 см

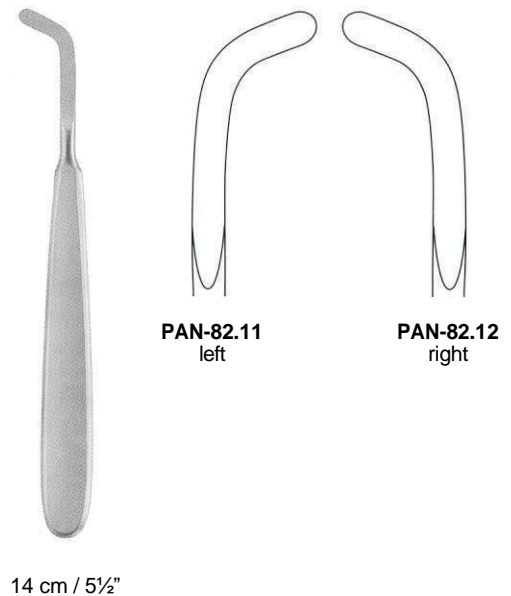

Распатор для уранопластики  
KAHRE, двухсторонний,  
остро/тупоконечный, 17 см



Распатор для уранопластики  
MCINDOE, двухсторонний,  
остро/тупоконечный, 16.5 см

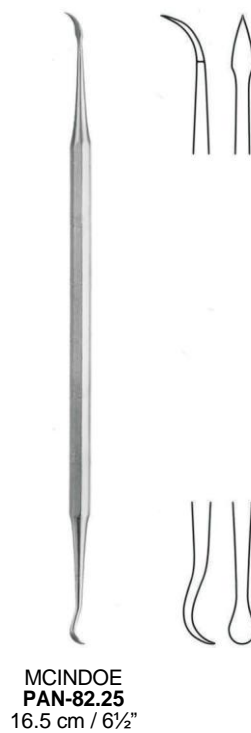

Элеватор для уранопластики Wang,  
15.5 см





Роторасширитель MOLT, с  
кремальной, 10 см / детский  
15 см / взрослый



**PAQ-06.10**  
10 cm / 4"  
for children

**PAQ-07.15**  
15 cm / 6"  
for adults

MOLT

Роторасширитель ROSER  
KONIG, замковый, 16 см



ROSER KONIG  
**PAQ-13.45**  
16 cm / 6 1/4"

Роторасширитель DENHART,  
замковый, 13 см



DENHART  
**PAQ-14.60**  
13 cm / 5 1/8"

Роторасширитель DINGMAN, комплект

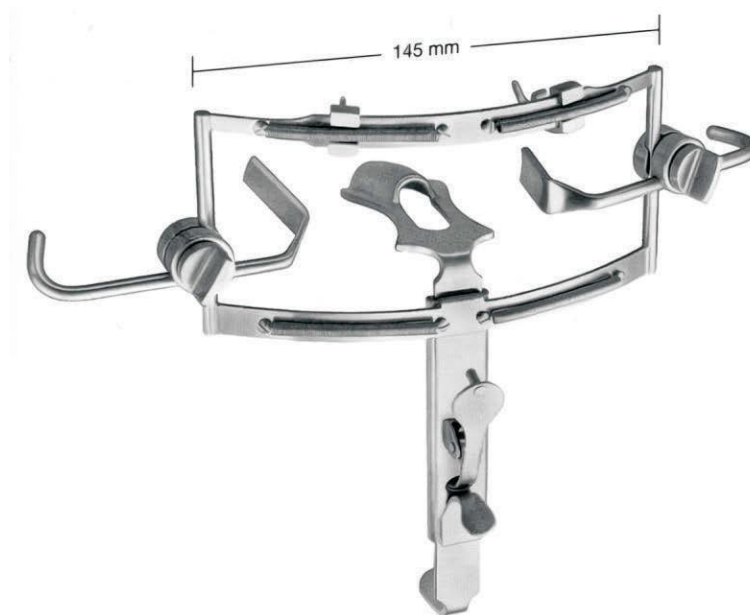

DINGMAN  
**PAQ-18.00**

Языкодержатели для  
роторасширителя DINGMAN



**PAQ-18.11**  
55 x 25 mm  
Fig.1

**PAQ-18.12**  
60 x 27 mm  
Fig.2

**PAQ-18.13**  
70 x 30 mm  
Fig.3



Роторасширитель WANG, комплект

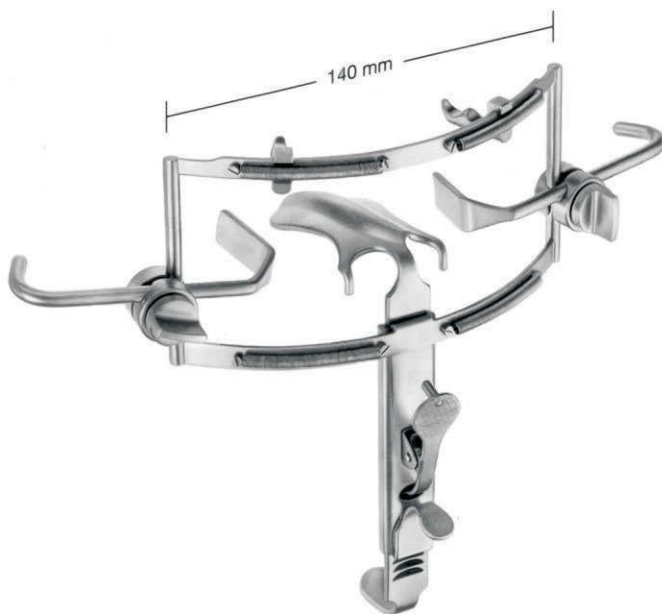

WANG  
PAQ-19.00

Языкодержатели для роторасширителя WANG



**PAQ-19.05**  
55 x 32 mm  
Fig.1

**PAQ-19.06**  
60 x 35 mm  
Fig.2

**PAQ-19.07**  
75 x 38 mm  
Fig.3

Щечный ретрактор  
STERNBERG, 14.5 см

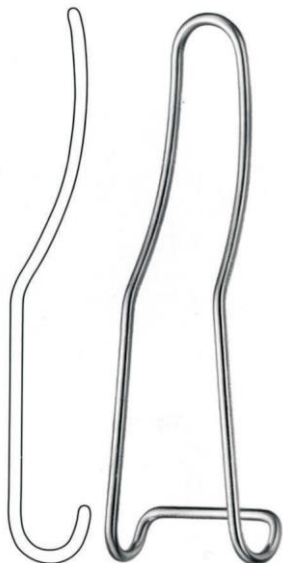

STERNBERG  
PAS-03.15  
14.5 cm / 5 3/4"

Ретрактор Minnesota для удержания мягких тканей и слизисто-надкостничного лоскута, 15.5 см



UNIV. MINNESOTA  
PAS-03.34  
15.5 cm / 6 1/8"

Ретрактор для щек и губ, металлический,  
универсальный, 15 см



PAS-15.27  
15 cm / 6"

Губной ретрактор,  
металлический, для  
верхней челюсти,  
21 см



PAS-15.21  
21 cm / 8 1/4"

Губной ретрактор,  
металлический, для  
нижней челюсти, 21 см



PAS-15.26  
26 cm / 10 1/4"

Lip and Cleft Palate Instruments

Ретракторы для палатосхизиса (расщелина нёба, волчья пасть)

Professional



Ретрактор для уранопластики # 1, изогнутый, 2 зуба, острые, 19 см

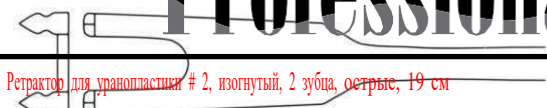

Ретрактор для уранопластики # 2, изогнутый, 2 зуба, острые, 19 см



#1



#2

PAS-07-35  
19 cm / 7 1/2"

Ретрактор для уранопластики # 3, плоский, изогнутый, 19 см

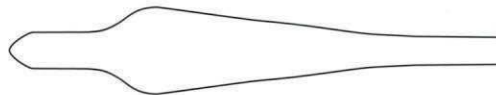

#3

PAS-07-36  
19 cm / 7 1/2"

PAS-07-37  
19 cm / 7 1/2"

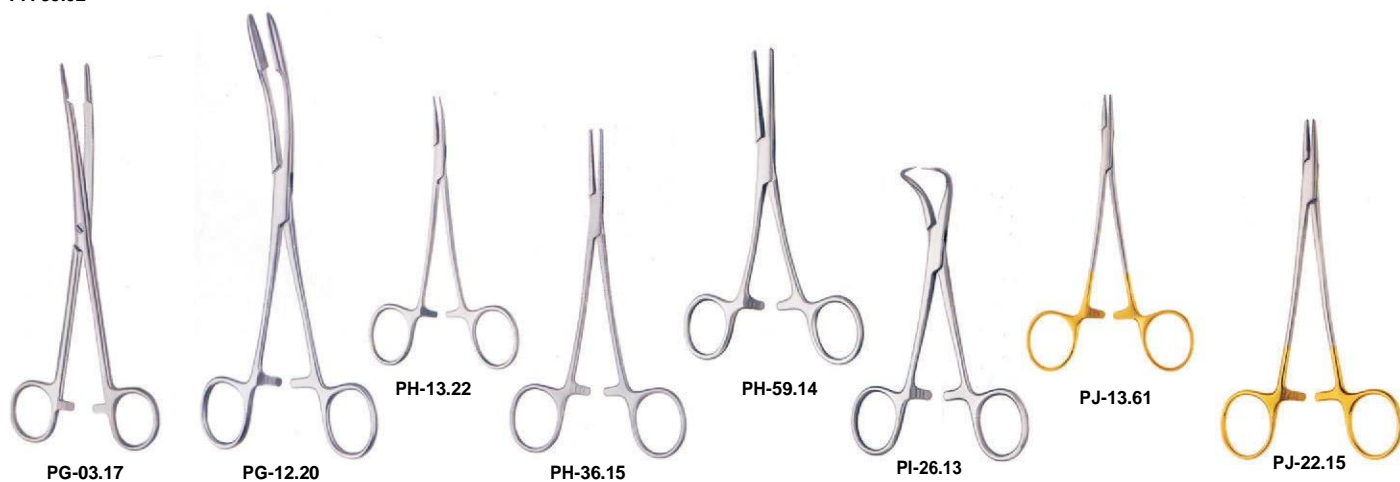
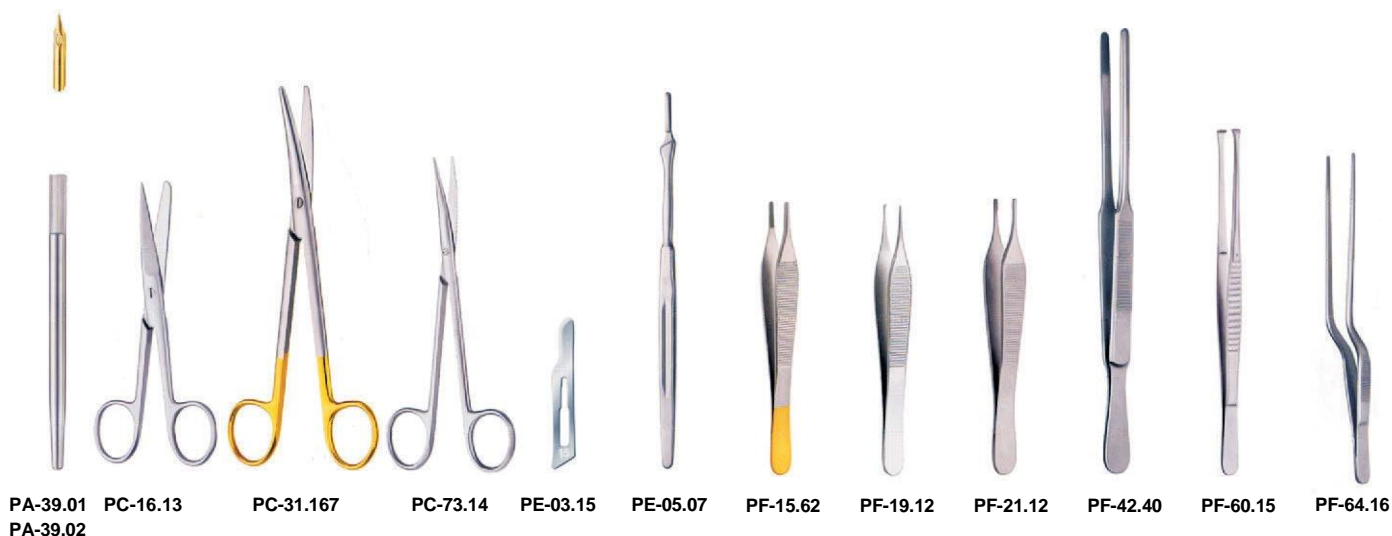

## ВАРИАНТ "А"

PF-19.12 Пинцет медицинский MICRO ADSON 1x2 зубый, деликатный, прямой, 12 см  
 PF-21.12 Пинцет захватывающий ADSON BROWN 7x7 зубцов, деликатный, прямой, 12 см  
 PF-42.40 Пинцет медицинский Swedish Pattern с насечкой, модифицированный, прямой, 20 см  
 PF-60.15 Пинцет для захватывания легкого NELSON 6x6 зубцов, прямой, 15 см  
 PF-64.16 Пинцет носовой штыковой GRUENWALD-JANSEN с насечкой, байонетный, 16 см  
 PH-13.22 Зажим кровоостанавливающий HALSTED MICRO MOSQUITO, с атравматической насечкой, изогнутый, 12.5 см  
 PH-36.15 Зажим гемостатический LERICHE 1x2 зубый, с атравматической насечкой, прямой, 15 см  
 PJ-13.61 Иглодержатель GUBISCH с зубчатой рабочей поверхностью, тип "T/C" (с твердосплавными вставками из карбида вольфрама), 12.5 см  
 PJ-22.15 Иглодержатель CRILE WOOD с зазубренными браншами, тип "T/C" (с твердосплавными вставками из карбида вольфрама), 15 см  
 PM-14.45 Молоток хирургический MALLETT, 26 см, с пластиковыми накладками, 240 гр, диаметр 45 мм  
 PT-15.05 Распатор односторонний WILLIGER, тупоконечный, ширина р/ч 5 мм, 16 см  
 PT-17.04 Элеватор для носовой перегородки Mckenty, острый, слегка изогнутый, ширина р/ч 4 мм, 15 см  
 PT-18.01 Распатор двусторонний FREER, острый, ширина р/ч 5/5 мм, 19 см  
 PT-46.08 Элеватор для расщелины неба LANGENBECK, узкий, тупоконечный, ширина р/ч 7 мм, 20 см  
 PY-21.05 Ретрактор JOSEPH, острый, 2 зубца, ширина р/ч 5 мм, 17 см  
 PY-25.13 Ретрактор-крючок GUTHRIE, двухзубый, острый, 1.5x2 мм, 13 см  
 PY-23.15 Ретрактор-крючок хирургический BARSKY, однозубый, острый, 3 мм, 15 см





PU-50.56



PAB-82.32



PAB-164.02



PAF-06.05  
PAF-06.06  
PAF-06.08  
PAF-06.10



PAM-11.62



PAM-14.56



PAM-20.16



PAM-44.03



PAN-33.94



PAN-33.97



PAN-04.37



PAN-10.17



PAN-27.55



PAN-27.62



PAN-28.54



PAN-40.53

## ВАРИАНТ "B"



PAN-55.20



PAN-70.01



PAN-70.75

- PU-50.56 Щипцы для хрящевого трансплантата AIACH, с прорезью, длина 15 см, бранши 5 мм
- PAB-82.32 Калипер (штангенциркуль) CASTROVIEJO, шкала 20 мм, 7 см
- PAB-164.02 DESMARRES ретрактор для века #2, 10x14 мм, 14 см
- PAM-11.62 Зеркало назальное COTTLE деликатное, 13 см
- PAM-20.16 Распатор носовой FREER, 16 см
- PAM-44.03 Назальные щипцы прямые WEIL-BLAKESLEY-WILDE #3, длина 120 мм, бранши 4.2 мм, решетчатые
- PAN-33.94 Распатор отсасывающий GUBISCH, градуированный, с байпасом, диам. 4 мм, 20 см
- PAN-33.97 Распатор отсасывающий GUBISCH, градуированный, с байпасом, диам. 4 мм, 17 см
- PAN-04.37 Ретрактор-крючок GUBISCH KILNER назальный, двухзубый, деликатный, р/ч 5x10 мм, 8 см
- PAN-10.17 Назальный ретрактор GUBISCH AUFRICHT, р/ч 50x6/12 мм, 17 см
- PAN-27.55 Долото COTTLE GUBISCH, плоское, градуированное, прямое, 5 мм, 18 см
- PAN-27.62 Долото COTTLE G
- PAN-55.20 Ножницы назальные пружинистые CAPLAN для рассечения перегородок, с зазубренными лезвиями, изогнутые по оси, тупоконечные, 20 см
- PAN-70.01 Костная мельница GUBISCH для ручной подготовки собственного костного трансплантата, 65x30MM
- PAN-70.75 Пластина для резки костного материала, тефлон, 85x55x10 мм

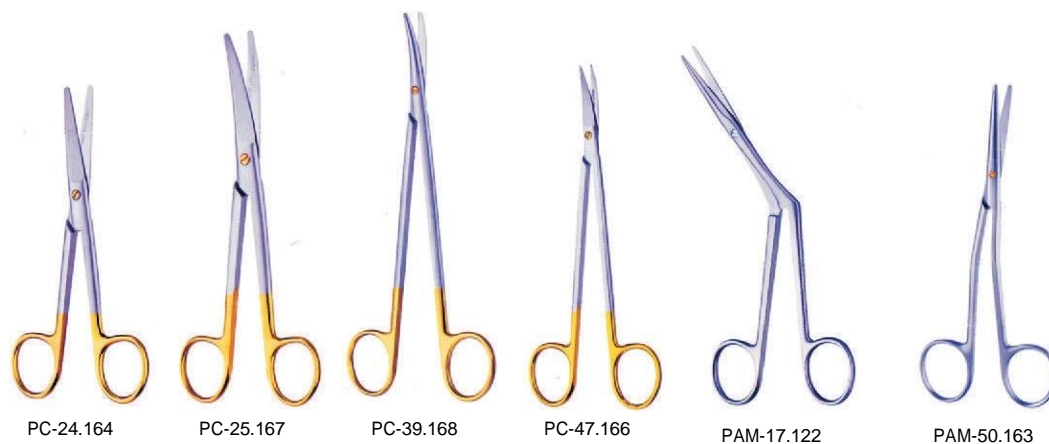

PC-24.164

PC-25.167

PC-39.168

PC-47.166

PAM-17.122

PAM-50.163



PAN-26.30

◀ or ▶



PAN-25.00



PAN-25.03



PAN-25.80-84



PAN-30.72



PAS-03.18

#### ВАРИАНТ "С"

- PC-24.164 Хирургические ножницы Mayo, тип Supercut Plus, с мелко-зазубренными лезвиями, прямые, тупоконечные, 14 см  
 PC-24.167 Хирургические ножницы Mayo, тип Supercut Plus, с мелко-зазубренными лезвиями, прямые, тупоконечные, 17 см  
 PC-39.168 Ножницы хирургические METZENBAUM, тип Supercut Plus, с мелко-зазубренными лезвиями, изогнутые по плоскости, тупоконечные, 15 см  
 PC-47.166 Ножницы хирургические KELLY, тип Supercut Plus, с мелко-зазубренными лезвиями, изогнутые по плоскости, остроконечные, 17 см  
 PAM-17.122 Назальные ножницы HEYMANN, тип Supercut, с зазубренными лезвиями, изогнутые по плоскости, тупоконечные, 18 см  
 PAM-50.163 Назальные ножницы FOMON, тип Supercut Plus, с мелко-зазубренными лезвиями, изогнутые по оси, тупоконечные, 13 см  
 PAN-26.30 Рашпиль носовой двухсторонний GUBISCH FOMON, тип "T/C" (р/ч из карбида вольфрама), 20см  
 PAN-25.00 Ручка для сменных назальных рашпелей "HM", односторонняя, 14см  
 PAN-25.03 Ключ для сменных назальных рашпелей к ручке PAN-25.00  
 PAN-25.81 Сменный назальный рашпиль #1, из карбида вольфрама  
 PAN-25.82 Сменный назальный рашпиль #2, из карбида вольфрама  
 PAN-25.83 Сменный назальный рашпиль #3, из карбида вольфрама  
 PAN-25.84 Сменный назальный рашпиль #4, из карбида вольфрама  
 PAN-30.72 Щипцы для операций на носовой перегородке RUBIN, тип "T/C" (р/ч из карбида вольфрама), концы овальные, с тонко зазубренными браншами, защитным колпачком, 20 см





PB-07.11 PC-17.14 PC-59.15 ? PE-06.17 PF-21.12 PF-34.32 PF-43.15 PF-60.26 PF-70.13



PG-19.20 PH-13.22 PI-25.08 PJ-45.18 PM-08.18 PT-23.04 PW-27.21 PX-39.19 PY-05.25 PY-24.16

### ВАРИАНТ "D"

- PC-59.15 Хирургические ножницы Ragnell (Kilner), тип Standard, изогнутые по плоскости, тупоконечные, 15 см
- PC-90.13 Ножницы для снятия швов FOX, тип Standard (одно лезвие зазубрено), прямые, остроконечные, 13 см
- PE-06.17 Ручка для скальпеля No. 7к, 12 см, #9, 10, 11, 12, 12D, 13, 15, 15C
- PF-21.12 Пинцет захватывающий ADSON BROWN 7x7 зубцов, деликатный, прямой, 12 см
- PF-34.32 Пинцет хирургический SEMKEN 2x3 зубый, тонкий, прямой, 12.5 см
- PF-43.15 Пинцет сосудистый DEBAKEY, ширина губок 1.5 мм, прямой, 15 см
- PF-60.26 Захватывающий пинцет Walter Bayonet, байонетный, зазубренный, 16 см
- PF-70.13 Пинцет ушной горизонтально-изогнутый TROELTSCH (WILDE), с насечками, взрослый, 13 см
- PH-13.22 Зажим кровоостанавливающий HALSTED MICRO MOSQUITO, с атравматической насечкой, изогнутый, 12.5 см
- PJ-45.18 Иголдержатель SENNING с короткой зазубренной рабочей частью, тип "Т/С" (с твердосплавными вставками из карбида вольфрама), 17 см
- PM-08.18 Молоток хирургический MEDICON, 18.5 см, с пластиковыми накладками, 200 гр, диаметр 25 мм
- PT-23.04 Распатор носовой LEMPERS, прямой, ширина р/ч 4 мм, 17 см
- PY-05.25 Ретрактор WALTER-COPE двусторонний, 17.5 см
- PY-24.16 Ретрактор-крючок назальный JOSEPH, однозубый, острый, 5 мм, 16 см
- PY-25.23 Ретрактор-крючок GUTHRIE, двухзубый, острый, 2x3 мм, 13 см
- PAC-243.14 Костная кюретка WILLIGER WALTER двусторонняя, изогнутая, острая, ширина р/ч 2 мм, 14 см
- PAM-34.11 Зажим назальный LUC-BRUNINGS (HEYMANN) #1, 18 см
- PAM-34.15 Пинцет назальный CRAIG, 17 см



PY-25.23 PAC-243.14 PAM-34.11 PAM-34.15

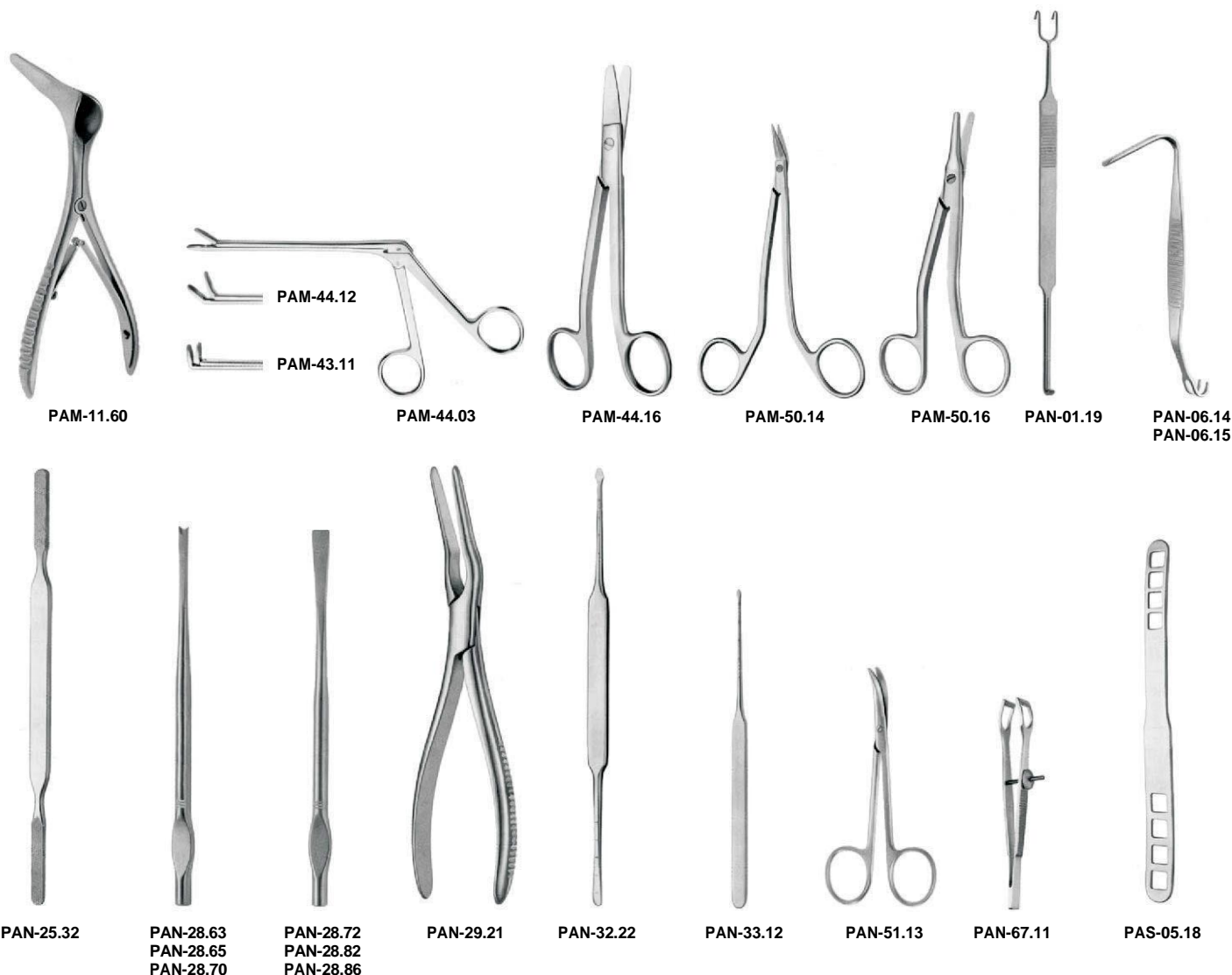

## ВАРИАНТ "Е"

- PAM-11.60 Зеркало назальное COTTLE, лезвия 50 мм, 14 см  
 PAM-44.12 Назальные щипцы угловые 45° WEIL-BLAKESLEY-WILDE #2, длина 120 мм, бранши 3.6 мм, решетчатые  
 PAM-44.03 Назальные щипцы прямые WEIL-BLAKESLEY-WILDE #3, длина 120 мм, бранши 4.2 мм, решетчатые  
 PAM-50.14 Ножницы для ринопластики WALTER, тип Supercut, с зазубренными лезвиями, S-изогнутые, острокопечные, 14 см  
 PAM-50.16 Назальные ножницы WALTER COTTLE, тип Supercut, с зазубренными лезвиями, изогнутые по оси, тупокопечные, 16 см  
 PAN-01.19 Носовой ретрактор NEIVERT, двухсторонний, градуированный, р/ч 5x10 мм, 19 см  
 PAN-06.14 Ретрактор назальный AUFRIEHT, двухсторонний, тупокопечный, р/ч 42x7 мм, 13.5 см  
 PAN-06.15 Ретрактор назальный AUFRIEHT, двухсторонний, тупокопечный, р/ч 38x7 мм, 13.5 см  
 PAN-25.32 Рапилиль носовой двухсторонний FOMON, 20 см  
 PAN-28.63 Остеотом носовой WALTER с закругленной режущей кромкой, 3 мм, 19 см  
 PAN-28.65 Остеотом носовой WALTER с закругленной режущей кромкой, 5 мм, 19 см  
 PAN-28.70 Остеотом носовой WALTER с закругленной режущей кромкой, 12 мм, 19 см  
 PAN-28.72 Остеотом носовой WALTER, 2 мм, 19 см  
 PAN-28.82 Остеотом носовой WALTER, 12 мм, 19 см  
 PAN-28.86 Остеотом носовой WALTER, изогнутый, 6 мм, 19 см  
 PAN-29.21 Щипцы для операций на носовой перегородке ASCH, изогнуты по оси, 22 см  
 PAN-32.22 Элеватор MASING двухсторонний, градуированный, полуострый/тупой, р/ч 5/5 мм, 22 см  
 PAN-33.12 Элеватор COTTLE односторонний, градуированный, полуострый, р/ч 2.5 мм, 16 см  
 PAN-51.13 Ножницы назальные AUFRIEHT, тип Supercut, с зазубренными лезвиями, изогнутые по оси, тупокопечные, 14 см  
 PAN-67.11 Пинцет COTTLE COLUMELLA, ширина бранш 12 мм, 11 см





### ВАРИАНТ "А"

- PC-02.112 Ножницы Iris, тип Supercut, с зазубренными лезвиями, изогнутые по плоскости, остроконечные, 12,5 см  
 PC-24.114 Хирургические ножницы Mayo, тип Supercut, с зазубренными лезвиями, прямые, тупоконечные, 14 см  
 PC-83.220 **либо** Ножницы для фейслифтинга атравматичные Solz ( Sims pattern) "Gold Tip", тип Supercut, с зазубренными плоскими лезвиями, изогнутыми по плоскости, тупоконечные, 20 см  
 PC-83.230 **либо** Ножницы для фейслифтинга атравматичные Solz ( Kaye pattern) "Gold Tip", тип Supercut, с зазубренными утолщенными лезвиями, изогнутыми по плоскости, тупоконечные, 20 см  
 PE-03.15 Лезвие для скальпеля Fig. 15 (100 шт)  
 PE-05.07 Ручка для скальпеля No. 7, длинная, 16,5 см для лезвий #9, 10, 11, 12, 12D, 13, 15, 15C  
 PF-19.12 Пинцет медицинский MICRO ADSON 1x2 зубый, деликатный, прямой, 12см  
 PF-21.12 Пинцет захватывающий ADSON BROWN 7x7 зубцов, деликатный, прямой, 12 см  
 PJ-13.61 Иглодержатель GUBISCH с зубчатой рабочей поверхностью, тип "Т/С" (с твердосплавными вставками из карбида вольфрама), 12,5 см  
 PY-12.19 Ретрактор-крючок хирургический GILLIES, 3 мм, 19 см  
 PY-21.05 Ретрактор JOSEPH, острый, 2 зубца, ширина р/ч 5 мм, 17 см  
 PY-46.12 Щечный ретрактор FARABEUF BABY, двухсторонний, 12 см (набор 2 шт)  
 PY-51.39 Ретрактор WALTER, двухсторонний, 4-зубый, 19 см





PE-04.03

PC-09.02

PC-09.03

PC-24.114

PH-10.12

PH-11.12



PJ-09.12

PJ-09.12

PY-21.05

PY-31.12

PAB-164.01

## ВАРИАНТ "B"

PE-04.03	Ручка для скальпеля No. 3, стандартная, для лезвий #9, 10, 11, 12, 12D, 13, 15, 15C
PC-24.114	Хирургические ножницы Mayo, тип Supercut, с зазубренными лезвиями, прямые, тупоконечные, 14 см
PH-10.12	Зажим кровоостанавливающий HALSTED MOSQUITO, с атравматической насечкой, прямой, 14 см
PH-11.12	Зажим кровоостанавливающий HALSTED MOSQUITO, с атравматической насечкой, изогнутый, 14 см
PJ-09.12	Иглодержатель NEIVERT, 12.5 см
PY-21.05	Ретрактор JOSEPH, острый, 2 зубца, ширина р/ч 5 мм, 17 см
PAB-164.01	DESMARRES ретрактор для века #1, 9x12 мм, 14 см



PD-04.32



PD-04.34



PF-83.51



PF-111.14



PF-102.42



PH-18.52



PH-19.52



PJ-107.26



PJ-107.27



PJ-106.28



PJ-106.29

**PAZ-25.00**KOSHIMA Micro instruments set - complete

Consisting of :

- PD-04.32**KOSHIMA Micro scissors . curved . vannas-type cutting edges (15cm)
- PD-04.34**KOSHIMA Micro scissors . straight . vannas-type cutting edges (15cm)
- PF-83.51**KOSHIMA Micro forceps (11 cm)
- PF-111.14**MICRO 2000 (KOSHIMAZ) micro forceps (14cm)
- PF-102.42**JACOBSON ADSON (KOSHIMA) Micro needle holder, straight . with catch (14.5 cm)
- PH-18.52**MICRO JACOBSON (KOSHIMA) Hemostatic forceps, straight (12.5cm)
- PH-19.52**MICRO JACOBSON (KOSHIMA) Hemostatic forceps, curved (12.5cm).
- PJ-107.26**CASTROVIEJO (KOSHIMA) Micro needle holder, curved . with catch (14.5 cm)
- PJ-107.27**CASTROVIEJO (KOSHIMA) Micro needle holder, curved, with catch (14.5cm)
- PJ-106.28**CASTROVIEJO (KOSHIMA) Micro needle holder, straight, (14.5cm)
- PJ-106.29**CASTROVIEJO (KOSHIMA) Micro needle holder, curved, (14.5cm)

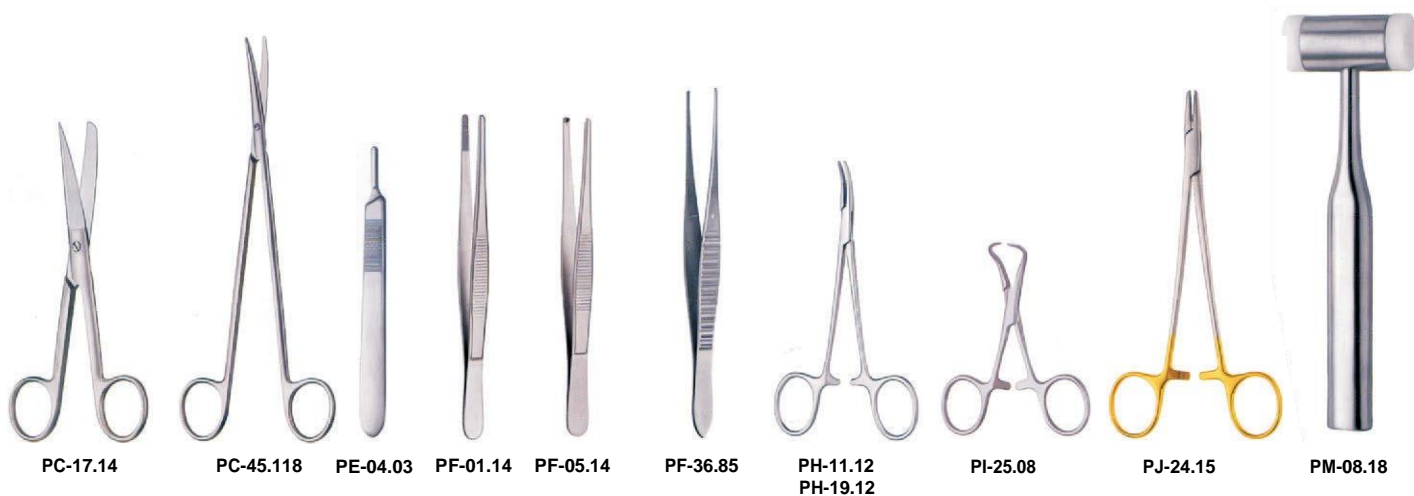

PC-17.14 PC-45.118 PE-04.03 PF-01.14 PF-05.14 PF-36.85 PH-11.12 PH-19.12 PI-25.08 PJ-24.15 PM-08.18



PU-38.19 PU-51.21 PV-12.12 PV-12.20 PV-60.20 PV-36.80 PV-36.85 PX-31.18 PY-54.04 PZ-30.13 PZ-30.16

- PC-17.14 Operating scissors, curved, sharp/blunt (14.5cm)
- PC-45.118 METZENBAUM slim Dissecting scissors, curved, (18cm)
- PE-04.03 Scalpel handle for blades figure 10-15 no. 3 (12.5cm)
- PF-01.14 Dressing forceps (14.5cm)
- PF-05.14 Tissue Forceps, 1x2 teeth (14.5cm)
- PF-36.85 GILLIES Tissue forceps, 1x2 teeth (15cm)
- PH-11.12 HALSTED MOSQUITO Hemostatic forceps, curved (12.5cm)
- PH-19.12 HALSTED MOSQUITO hemostatic forceps, curved, 1 x 2 teeth (12.5cm)
- PI-25.08 BACKHAUS Towel clamp (8.5cm)
- PJ-24.15 MAYO HEGAR TC needle holder, fine (15cm)
- PM-08.18 Mallet, with plastic facings, unscrewable, 200 g (18.5 cm)
- PU-38.19 DIGNMAN Bone holding forceps (19 cm)
- PU-51.21 LANGENBECK Bone holding forceps (20 cm)
- PV-12.12 STILLE Osteotome, 12 mm (20 cm)
- PV-12.20 STILLE Osteotome, 20 mm (20 cm)
- PV-60.20 LEXER Gouge, 20 mm (22 cm)
- PV-36.80 LEXER Gouge, 10 mm (25 cm)
- PV-36.85 LEXER Gouge, 15 mm (25 cm)
- PX-31.18 BEYER Bone rongeur (18 cm)
- PY-54.04 VOLKMANN Retractor, 4 teeth, 18mm, sharp (20 cm)
- PZ-30.13 VOLKMANN Retractor, 4 teeth, 18mm, sharp (20 cm)
- PZ-30.16 WEITLANER Self-retaining retractor, blunt (16.5 cm)
- PAG-14.25 GIERTZ Rib shears (25 cm)
- PAG-46.11 DOYEN Rip raspatory, right (17cm)
- PAG-46.12 DOYEN Rip raspatory, left (17cm)
- PAN-36.63 OBWEGESER Raspatory, 9 mm (18cm)



PAG-14.25 PAG-46.11 PAG-46.12 PAN-36.63



PAF-06.06

- PC-39.20 METZENBAUM Dissecting scissors, curved (20cm)
- PC-64.14 JABALEY Delicate scissors, standard, curved (13cm)
- PC-64.114 JABALEY Delicate scissors, supercut, curved (13 cm)
- PC-83.220 SOLZ Dissecting scissors "Gold Tip", supercut, curved (20 cm)
- PC-83.230 SOLZ Dissecting scissors "Gold Tip", supercut, curved, (20 cm)
- PE-03.15 Scalpel blade, no 15, packing unit 100 pieces, sterile
- PE-05.07 Scalpel handle, no. 7 (16.5 cm)
- PF-19.12 MICRO ADSON Delicate forceps dressing/ tissue, 1x2 teeth (12 cm)
- PF-65.19 GRUENWALD Bayonet forceps (19.5cm)
- PJ-32.15 BABY CRILE WOOD Needle holder, fine (15 cm)
- PJ-33.15 BABY CRILE WOOD TC Needle holder, fine (15cm)
- PY-46.12 FARABEUF BABY Retractor, double-ended, 10/12 mm, packing unit 2 pieces (12 cm)
- PY-77.13 LANGENBECK KOCHER Retractor, 15 x 80 mm (21 cm)
- PY-90.10 SOLZ Non-traumatical breast dissector (34 cm)
- PY-90.11 SOLZ Non-traumatical breast dissector (37 cm)
- PY-90.15 SOLZ Hook dissector (36 cm)
- PY-90.20 SOLZ Areola marker, blunt(Ø = 36 mm)
- PY-90.25 SOLZ Areola marker, blunt(Ø = 40 mm)
- PY-90.30 SOLZ Areola marker, blunt(Ø = 42 mm)
- PY-90.35 SOLZ Areola marker, blunt(Ø = 45 mm)
- PY-90.40 MARX Breast retractor, 125 x 30 mm (27 cm)
- PY-90.45 MARX Breast retractor, 140 x 30 mm (27 cm)
- PAF-06.06 Bowl for marking colour, 0.06 | (Ø = 6 cm)





- PC-37.164 METZENBAUM Dissecting scissors, supercut plus, curved (18cm)
- PF-03.14 Delicate forceps dressing/ tissue (14.5 cm)
- PF-07.14 Delicate forceps dressing/ tissue, 1 x 2 teeth (14.5 cm)
- PH-13.12 HALSTED MOSQUITO Hemostatic forceps, curved (14 cm)
- PJ-24.20 MAYO HEGAR "TC" Needle holder, normal (20 cm)
- PJ-27.68 MICRO SLIM "TC" Needle holder, fine (18cm)
- PY-25.23 GUTHRIE Delicate retractor, 2 teeth , sharp (13 cm)

## Harvesting of Costal Cartilages

Набор инструментов для пересадки реберных хрящей



- PC-25.114 MAYO Delicate scissors, supercut, curved (14cm)
- PF-35.15 McINDOE Delicate forceps dressing / tissue (15 cm)
- PF-36.85 GILLIES Delicate forceps dressing/ tissue, 1x2 teeth (15cm)
- PT-18.24 COHEN Elevator, double-ended, 5 mm (24 cm)
- PY-02.16 SENN-MILLER Delicate retractor, double-ended, blunt (16cm)
- PY-24.16 JOSEPH Delicate retractor (16cm)
- PY-71.10 LANGENBECK Retractor, 10 x 40 mm (21 cm)
- PY-71.13 LANGENBECK Retractor, 13 x 42 mm (21 cm)
- PY-76.32 KOCHER Retractor, 12 x 60 mm (21 cm)
- PAM-30.50 PENNINGTON Septum elevator, double-ended (20cm)
- PAN-37.18 DINGMANN Raspatory, double-ended (18cm)
- PAP-40.17 JACKSON Delicate retractor, double-ended, blunt (18cm)



PE-22.01



PE-22.02



PE-22.04



PE-22.05



PE-22.06



PF-15.12



PF-16.12



PF-35.15



PF-41.25



PH-11.12



PJ-08.61  
PJ-08.63



PJ-69.17



PS-24.12



PT-11.26



PT-11.27



PU-04.65



PU-75.40



PAB-196.142



PAB-196.143



PAG-46.11 PAG-46.12

- PE-22.01 NAGATA Sculptur knife handle , small (12 cm)
- PE-22.02 NAGATA Sculptur knife handle , large (12 cm)
- PE-22.04 NAGATA Sculptur knife blade, 3.0mm (8 cm)
- PE-22.05 NAGATA Sculptur knife blade, 4.5mm (8 cm)
- PE-22.06 NAGATA Sculptur knife blade, 6.0mm (8.5 cm)
- PF-15.12 ADSON Delicate forceps dressing/ tissue, serrated (12 cm)
- PF-16.12 ADSON Delicate forceps dressing/ tissue, 1 x 2 teeth (12 cm)
- PF-35.15 McINDOE Delicate forceps dressing/ tissue, serrated (15 cm)
- PF-41.25 GILLIES Delicate forceps dressing/ tissue , 1 x 2 teeth (15 cm)
- PH-11.12 HALSTED MOSQUITO Hemostatic forceps, curved (12.5cm)
- PJ-08.61 NAGATA "TC" Needle holder, smooth (11.5cm)
- PJ-08.63 NAGATA "TC" Needle holder, smooth (13cm)
- PJ-69.17 MATHIEU "TC" Needle holder, regular (17cm)
- PS-24.12 UNIVERSAL "TC" Wire cutting scissors, serrated cutting edge (12cm)
- PT-11.26 NAGATA Septum elevator, blunt, double-ended (16cm)
- PT-11.27 NAGATA Septum elevator, blunt, double-ended (17cm)
- PU-04.65 NIROL "TC" Wire twisting forceps (15cm)
- PU-75.40 NIROL "TC" Wire twisting forceps (15cm)
- PAB-196.142 Delicate dissecting scissors, supercut, straight (12cm)
- PAB-196.143 Delicate dissecting scissors, supercut, curved (12cm)
- PAG-46.11 DOYEN Rip raspatory , right (17cm)
- PAG-46.12 DOYEN Rip raspatory , left (17cm)



PC-10.113

PC-24.114

PC-59.13

PC-77.133

PC-80.123

PC-83.220

PC-82.230



PE-01.15

PE-02.21

PE-05.07

PE-10.64

PF-16.15

PF-21.13

PF-41.20

PF-41.25

PI-25.08

PJ-13.62

PJ-24.15

PJ-24.23

PY-21.10

PY-46.12

- PC-10.113 STEVENS Delicate scissors (iris), supercut, curved (11.5cm)
- PC-24.114 MAYO Dissecting scissors, supercut , straight (14cm)
- PC-59.13 RAGNELL (KILNER) Delicate Dissecting scissors, curved (13 cm)
- PC-77.133 GORNEY Dissecting scissors, supercut, curved (23 cm)
- PC-80.123 GORNEY FREEMAN Dissecting scissors, supercut, curved (23 cm)
- optional
- PC-83.220 SOLZ Dissecting scissors "Gold Tip" , supercut, curved (20cm)
- PC-83.230 SOLZ Dissecting scissors "Gold Tip" , supercut, curved (20 cm)
- PE-01.15 Scalpel blade, no .15 , packing unit 100 pieces, sterile
- PE-02.21 Scalpel blade, no.21 , packing unit 100 pieces, sterile
- PE-05.07 Scalpel handle, no.7 (16.5 cm)
- PE-10.64 Scalpel handle, no.4L (21cm)
- PF-16.15 ADSON Delicate forceps dressing/ tissue, 1 x 2 teeth (15cm)
- PF-21.13 ADSON BROWN Delicate forceps dressing/ tissue , 9x9 teeth (12 cm)
- PF-41.20 POTTS SMITH Forceps dressing/ tissue , 1 x 2 teeth (21 cm)
- PF-41.25 ADSON Delicate forceps dressing/ tissue, 1 x 2 teeth (25 cm)
- PI-25.08 BACKHAUS Towel clamp (8,5cm)
- PJ-13.62 WRIGHT (DERF) "TC" Needle holde, fine (12.5cm)
- PJ-24.15 MAYO HEGAR "TC" Needle holder, fine (15 cm)
- PJ-24.23 MAYO HEGAR "TC" Needle holder, fine (23 cm)
- PY-21.10 JOSEPH Delicate retractor, 2 teeth , 10 mm , sharp (17cm)
- PY-46.12 FARABEUF BABY Retractor, double-ended, 10/12 mm, packing unit 2 pieces (12 cm)
- PY-74.06 ISRAEL Retractor, 60 x 50 mm , blunt , 6 teeth ( 25 cm)
- PY-90.50 SALDANHA SOLZ Abdominal retractor (37cm)
- PY-90.53 SOLZ Navel marker, dismantable (29 cm)



PY-74.06

PY-90.50

PY-90.53



Item No.	Page No.	Item No.	Page No.	Item No.	Page No.
PA-37.15	002	PC-12.132	008	PC-37.114	011
PA-37.20	002	PC-12.32	008	PC-37.115	011
PA-37.30	002	PC-12.52	008	PC-37.14	011
PA-37.50	002	PC-12.62	007	PC-37.15	011
PA-38.10	002	PC-12.70	008	PC-37.161	010
PA-38.30	002	PC-12.90	008	PC-37.164	011
PA-38.40	002	PC-13.60	007	PC-37.61	010
PA-38.41	002	PC-13.61	007	PC-37.64	011
PA-38.44	003	PC-13.62	007	PC-38.118	011
PA-39.01	003	PC-13.63	008	PC-38.120	011
PA-39.02	003	PC-24.114	009	PC-38.168	011
PC-01.09	006	PC-24.117	009	PC-38.170	011
PC-01.10	006	PC-24.14	009	PC-38.18	011
PC-01.11	006	PC-24.164	009	PC-38.20	011
PC-01.110	006	PC-24.167	009	PC-38.68	011
PC-01.111	006	PC-24.17	009	PC-38.70	011
PC-01.12	006	PC-24.64	009	PC-39.118	011
PC-01.171	006	PC-24.67	009	PC-39.120	011
PC-02.09	006	PC-25.114	009	PC-39.168	011
PC-02.10	006	PC-25.117	009	PC-39.170	011
PC-02.11	006	PC-25.14	009	PC-39.18	011
PC-02.110	006	PC-25.164	009	PC-39.20	011
PC-02.111	006	PC-25.167	009	PC-39.68	011
PC-02.112	006	PC-25.17	009	PC-39.70	011
PC-02.12	006	PC-25.64	009	PC-40.123	012
PC-02.171	006	PC-25.67	009	PC-40.126	012
PC-03.30	006	PC-30.115	009	PC-40.130	012
PC-04.130	006	PC-30.117	009	PC-40.173	012
PC-04.30	006	PC-30.15	009	PC-40.23	012
PC-05.161	006	PC-30.17	009	PC-40.26	012
PC-05.171	006	PC-31.165	009	PC-40.30	012
PC-05.61	006	PC-31.167	009	PC-40.73	012
PC-05.71	006	PC-31.65	009	PC-41.123	013
PC-06.161	006	PC-31.67	009	PC-41.126	013
PC-06.171	006	PC-32.116	010	PC-41.130	013
PC-06.61	006	PC-32.117	010	PC-41.173	013
PC-06.71	006	PC-32.17	010	PC-41.176	013
PC-09.70	007	PC-32.187	010	PC-41.180	013
PC-09.71	007	PC-32.197	010	PC-41.23	013
PC-10.112	007	PC-32.86	010	PC-41.26	013
PC-10.113	007	PC-32.97	010	PC-41.30	013
PC-10.115	007	PC-34.196	010	PC-41.73	013
PC-10.12	007	PC-34.96	010	PC-41.76	013
PC-10.13	007	PC-35.196	010	PC-41.80	013
PC-10.15	007	PC-35.96	010	PC-42.114	013
PC-10.70	007	PC-36.109	012	PC-42.14	013
PC-10.71	007	PC-36.11	010	PC-42.164	013
PC-11.10	007	PC-36.111	010	PC-42.64	013
PC-11.112	007	PC-36.114	011	PC-43.114	014
PC-11.12	007	PC-36.14	011	PC-43.14	014
PC-11.132	008	PC-36.164	011	PC-43.164	014
PC-11.32	008	PC-36.61	010	PC-43.64	014
PC-11.52	008	PC-36.64	011	PC-44.118	013
PC-11.70	008	PC-36.161	010	PC-44.120	013
PC-12.10	007	PC-37.109	012	PC-44.123	013
PC-12.112	007	PC-37.11	010	PC-44.168	013
PC-12.12	007	PC-37.111	010	PC-44.170	013

Item No.	Page No.	Item No.	Page No.	Item No.	Page No.
PC-44.173	013	PC-59.165	016	PC-77.67	020
PC-44.18	013	PC-59.168	016	PC-77.69	020
PC-44.20	013	PC-59.18	016	PC-77.73	020
PC-44.23	013	PC-59.20	016	PC-80.01	021
PC-44.68	013	PC-59.63	016	PC-80.117	020
PC-44.70	013	PC-59.65	016	PC-80.119	020
PC-44.73	013	PC-59.68	016	PC-80.123	020
PC-45.118	014	PC-60.122	017	PC-80.152	021
PC-45.120	014	PC-61.122	017	PC-80.37	020
PC-45.123	014	PC-64.11	017	PC-80.39	020
PC-45.168	014	PC-64.111	017	PC-80.43	020
PC-45.170	014	PC-64.112	017	PC-80.72	021
PC-45.173	014	PC-64.113	017	PC-81.115	021
PC-45.176	014	PC-64.114	017	PC-81.117	021
PC-45.178	014	PC-64.12	017	PC-81.119	022
PC-45.18	014	PC-64.13	017	PC-81.123	022
PC-45.20	014	PC-64.14	017	PC-81.132	022
PC-45.23	014	PC-65.114	017	PC-81.37	021
PC-45.68	014	PC-65.134	018	PC-81.39	022
PC-45.70	014	PC-65.14	017	PC-81.43	022
PC-45.73	014	PC-65.144	018	PC-83.220	022
PC-46.116	016	PC-66.114	017	PC-83.230	022
PC-46.16	016	PC-66.134	018	PC-90.113	023
PC-46.166	016	PC-66.14	017	PC-90.13	023
PC-46.168	015	PC-66.144	018	PC-90.163	023
PC-46.170	015	PC-67.114	018	PC-90.63	023
PC-46.173	015	PC-67.14	018	PC-91.113	023
PC-46.178	015	PC-67.164	018	PC-91.13	023
PC-46.180	015	PC-67.18	018	PC-91.163	023
PC-46.183	015	PC-67.20	018	PC-91.63	023
PC-46.66	016	PC-67.64	018	PD-01.20	030
PC-46.78	015	PC-68.114	018	PD-01.21	030
PC-46.80	015	PC-68.118	018	PD-01.120	030
PC-46.83	015	PC-68.14	018	PD-01.121	030
PC-47.116	016	PC-68.164	018	PD-01.22	030
PC-47.16	016	PC-68.18	018	PD-01.23	030
PC-47.166	016	PC-68.20	018	PD-01.30	030
PC-47.168	015	PC-68.64	018	PD-01.31	030
PC-47.170	015	PC-69.117	019	PD-01.74	030
PC-47.173	016	PC-70.118	019	PD-01.75	030
PC-47.66	015	PC-72.12	019	PD-01.76	030
PC-48.116	015	PC-72.14	019	PD-01.77	030
PC-49.116	015	PC-72.16	019	PD-07.20	030
PC-50.118	014	PC-72.18	019	PD-07.21	030
PC-50.168	014	PC-73.112	019	PD-07.25	030
PC-50.18	014	PC-73.116	019	PD-07.26	030
PC-50.68	014	PC-73.118	019	PD-08.02	030
PC-58.131	016	PC-73.14	019	PE-03.10	032
PC-58.132	016	PC-73.16	019	PE-03.11	032
PC-58.61	016	PC-73.18	019	PE-03.12	032
PC-58.62	016	PC-74.116	020	PE-03.15	032
PC-59.113	016	PC-74.120	020	PE-03.21	032
PC-59.115	016	PC-74.126	020	PE-03.23	032
PC-59.118	016	PC-74.130	020	PE-03.32	032
PC-59.13	016	PC-77.127	020	PE-03.35	032
PC-59.15	016	PC-77.129	020	PE-04.03	032
PC-59.163	016	PC-77.133	020	PE-05.07	032

Item No.	Page No.	Item No.	Page No.	Item No.	Page No.
PE-06.17	032	PF-37.15	041	PJ-05.13	050
PE-07.13	032	PF-37.20	041	PJ-06.15	050
PE-08.23	032	PF-38.15	041	PJ-07.65	050
PE-10.40	032	PF-38.20	041	PJ-08.61	050
PE-10.45	033	PF-42.40	041	PJ-08.63	050
PE-10.53	033	PF-43.15	041	PJ-09.12	050
PE-10.61	033	PF-60.15	041	PJ-10.62	050
PE-10.63	033	PF-60.23	041	PJ-12.12	051
PE-10.64	033	PF-60.26	041	PJ-13.61	051
PE-10.86	034	PF-60.36	041	PJ-13.62	051
PE-10.87	034	PF-64.16	042	PJ-14.13	051
PE-10.90	034	PF-70.13	042	PJ-15.63	051
PE-10.92	034	PF-71.50	042	PJ-17.82	051
PE-10.94	034	PF-71.51	042	PJ-21.18	052
PE-10.95	034	PF-71.52	042	PJ-21.20	052
PE-10.97	034	PF-71.53	042	PJ-21.23	052
PE-22.02	035	PF-71.60	042	PJ-22.15	052
PE-22.04	035	PF-71.61	042	PJ-22.18	052
PE-22.05	035	PF-71.62	042	PJ-22.20	052
PE-22.06	035	PF-71.63	042	PJ-22.23	052
PE-30.30	036	PF-71.70	042	PJ-22.25	052
PE-30.31	036	PF-71.71	042	PJ-22.30	052
PE-30.32	036	PF-71.72	042	PJ-23.15	053
PE-30.50	036	PF-71.73	042	PJ-23.18	053
PE-30.51	036	PF-71.84	042	PJ-23.20	053
PE-30.52	036	PH-04.08	046	PJ-23.23	053
PE-30.60	036	PH-04.12	046	PJ-23.24	053
PF-07.14	038	PH-04.16	046	PJ-24.15	053
PF-15.12	038	PH-04.28	046	PJ-24.18	053
PF-15.62	038	PH-04.32	046	PJ-24.20	053
PF-15.65	038	PH-04.36	046	PJ-24.23	053
PF-16.01	038	PH-10.12	046	PJ-24.24	053
PF-16.05	038	PH-10.22	046	PJ-24.26	053
PF-16.12	039	PH-11.12	046	PJ-24.30	053
PF-16.13	039	PH-13.22	046	PJ-34.15	052
PF-16.15	039	PH-14.42	047	PJ-45.15	054
PF-16.62	042	PH-15.42	047	PJ-45.16	054
PF-16.65	042	PH-18.12	046	PJ-45.17	054
PF-17.12	042	PH-18.22	046	PJ-45.18	054
PF-18.15	039	PH-18.42	047	PJ-46.17	054
PF-19.12	039	PH-18.52	047	PJ-47.20	054
PF-20.15	039	PH-18.60	047	PJ-48.20	054
PF-21.12	039	PH-18.62	047	PJ-48.24	054
PF-21.13	039	PH-19.12	047	PJ-48.26	054
PF-22.72	040	PH-19.22	047	PJ-48.30	054
PF-23.82	040	PH-19.42	047	PJ-53.14	055
PF-30.12	040	PH-19.52	047	PJ-54.15	055
PF-30.15	040	PH-19.60	047	PJ-55.15	055
PF-31.22	040	PH-19.62	047	PJ-55.31	055
PF-31.25	040	PH-30.14	048	PJ-55.34	055
PF-32.12	040	PH-31.14	048	PJ-55.37	055
PF-32.15	040	PH-32.14	048	PJ-55.58	055
PF-33.22	040	PH-33.14	048	PJ-56.16	056
PF-33.25	040	PH-34.15	048	PJ-69.14	056
PF-34.32	040	PH-35.15	048	PJ-69.17	056
PF-35.15	040	PH-36.15	048	PJ-69.20	056
PF-36.85	041	PH-37.15	048	PJ-69.24	056

Item No.	Page No.	Item No.	Page No.	Item No.	Page No.
PK-21.15	057	PT-18.01	061	PY-24.36	069
PK-21.18	057	PT-18.02	062	PY-24.42	069
PK-21.21	057	PT-18.03	062	PY-24.50	069
PK-21.38	057	PT-18.24	062	PY-24.51	069
PK-21.41	057	PT-18.38	062	PY-25.13	069
PK-22.13	057	PT-23.02	062	PY-25.15	069
PK-22.15	057	PT-23.03	062	PY-25.23	069
PK-22.18	057	PT-23.04	062	PY-29.01	070
PK-22.21	057	PT-23.05	062	PY-29.02	070
PK-22.38	057	PT-23.06	062	PY-29.03	070
PK-22.41	057	PT-38.18	063	PY-29.04	070
PK-31.15	057	PT-38.19	063	PY-30.01	070
PK-31.18	057	PT-38.28	063	PY-30.02	070
PK-31.21	057	PT-38.29	063	PY-30.03	070
PK-31.41	057	PT-46.08	063	PY-30.04	070
PK-32.13	057	PT-46.10	063	PY-31.15	070
PK-32.15	057	PU-04.50	064	PY-32.62	070
PK-32.18	057	PU-04.65	064	PY-32.63	070
PK-32.21	057	PU-04.76	064	PY-33.01	071
PK-32.41	057	PU-48.43	064	PY-33.02	071
PK-33.15	057	PU-50.56	064	PY-33.03	071
PK-33.18	057	PU-74.20	064	PY-33.04	071
PK-33.21	057	PU-75.40	064	PY-33.05	071
PK-33.38	057	PY-01.16	066	PY-33.06	071
PK-33.41	057	PY-02.16	066	PY-33.62	070
PK-34.13	057	PY-05.16	066	PY-33.63	070
PK-34.15	057	PY-05.18	066	PY-46.12	071
PK-34.18	057	PY-05.25	066	PY-47.15	071
PK-34.21	057	PY-07.50	066	PY-51.39	071
PK-34.38	057	PY-07.52	066	PY-71.10	072
PK-34.41	057	PY-07.58	066	PY-71.12	072
PM-08.18	060	PY-07.65	067	PY-71.13	072
PM-08.40	060	PY-07.66	067	PY-71.16	072
PM-08.75	060	PY-07.75	067	PY-76.31	072
PM-14.35	060	PY-07.85	067	PY-76.32	072
PM-14.45	060	PY-08.20	067	PY-90.00	073
PM-14.50	060	PY-09.20	067	PY-90.10	074
PS-19.09	023	PY-10.20	067	PY-90.11	074
PS-20.10	023	PY-11.12	067	PY-90.15	074
PS-20.12	023	PY-12.19	067	PY-90.20	073
PS-20.60	023	PY-12.20	067	PY-90.25	073
PS-20.62	023	PY-20.13	068	PY-90.30	073
PS-21.13	023	PY-21.02	068	PY-90.35	073
PS-21.35	023	PY-21.05	068	PY-90.40	075
PS-22.09	024	PY-21.07	068	PY-90.45	075
PS-24.12	024	PY-21.10	068	PY-90.50	076
PS-36.84	024	PY-23.03	068	PY-90.53	077
PS-36.88	024	PY-23.05	068	PY-100.01	078
PS-36.93	024	PY-23.07	068	PY-100.02	078
PT-11.26	061	PY-23.15	068	PY-100.03	078
PT-11.27	061	PY-23.16	068	PY-100.04	078
PT-13.04	061	PY-24.14	068	PY-100.05	078
PT-15.03	061	PY-24.15	068	PZ-14.01	079
PT-15.05	061	PY-24.16	069	PZ-14.02	079
PT-15.07	061	PY-24.21	069	PZ-15.03	079
PT-17.04	061	PY-24.24	069	PZ-15.04	079
PT-17.05	061	PY-24.26	069	PZ-16.52	079

Item No.	Page No.	Item No.	Page No.	Item No.	Page No.
PZ-17.05	079	PAM-11.62	089	PAM-45.12	092
PZ-17.06	079	PAM-14.14	089	PAM-45.13	092
PZ-18.07	079	PAM-14.15	089	PAM-45.14	092
PZ-18.08	079	PAM-14.16	089	PAM-45.15	092
PZ-19.07	079	PAM-14.17	089	PAM-50.113	026
PZ-19.08	079	PAM-14.59	089	PAM-50.13	026
PZ-23.09	079	PAM-16.15	089	PAM-50.14	026
PZ-23.10	079	PAM-16.16	089	PAM-50.16	026
PZ-24.07	079	PAM-16.17	089	PAM-50.163	026
PZ-24.08	079	PAM-17.122	025	PAM-50.177	026
PZ-25.10	079	PAM-17.17	025	PAM-50.77	026
PZ-25.11	079	PAM-17.20	025	PAM-51.116	026
PZ-26.13	080	PAM-17.21	025	PAM-51.136	026
PZ-27.10	080	PAM-20.16	090	PAM-51.16	026
PZ-28.11	080	PAM-24.16	090	PAM-51.36	026
PZ-28.12	080	PAM-24.17	090	PAM-51.63	027
PZ-29.13	080	PAM-25.16	090	PAN-01.17	094
PZ-29.16	080	PAM-25.17	090	PAN-01.19	094
PZ-30.13	080	PAM-25.46	090	PAN-01.20	094
PZ-30.14	080	PAM-25.47	090	PAN-01.21	094
PZ-30.16	080	PAM-30.50	090	PAN-01.23	094
PZ-30.17	080	PAM-34.11	091	PAN-01.44	094
PAB-164.00	081	PAM-34.12	091	PAN-02.14	094
PAB-164.01	081	PAM-34.15	091	PAN-03.14	094
PAB-164.02	081	PAM-34.16	091	PAN-04.10	095
PAB-164.03	081	PAM-34.17	091	PAN-04.14	094
PAB-164.04	081	PAM-34.75	091	PAN-04.15	095
PAB-196.142	008	PAM-44.01	092	PAN-04.37	095
PAB-196.143	008	PAM-44.02	092	PAN-05.14	095
PAB-196.42	008	PAM-44.03	092	PAN-05.16	095
PAB-196.43	008	PAM-44.04	092	PAN-06.14	095
PAB-57.18	043	PAM-44.05	092	PAN-06.15	095
PAB-82.32	003	PAM-44.11	092	PAN-06.17	095
PAB-82.41	003	PAM-44.12	092	PAN-06.30	096
PAB-82.42	003	PAM-44.13	092	PAN-09.12	096
PAB-82.43	003	PAM-44.14	092	PAN-10.17	096
PAC-243.14	062	PAM-44.15	092	PAN-10.19	096
PAF-06.06	073	PAM-44.26	093	PAN-11.08	097
PAG-46.11	086	PAM-44.27	093	PAN-12.15	097
PAG-46.12	086	PAM-44.28	093	PAN-13.14	097
PAK-25.117	025	PAM-44.35	093	PAN-13.16	097
PAK-25.17	025	PAM-44.36	093	PAN-14.15	097
PAM-04.16	087	PAM-44.37	093	PAN-15.14	097
PAM-05.20	087	PAM-44.59	093	PAN-17.26	097
PAM-06.20	087	PAM-44.60	093	PAN-17.27	097
PAM-06.21	087	PAM-44.61	093	PAN-18.24	098
PAM-06.30	088	PAM-44.71	092	PAN-19.24	098
PAM-08.15	088	PAM-44.72	092	PAN-20.24	098
PAM-08.16	088	PAM-44.73	092	PAN-21.24	098
PAM-08.17	088	PAM-44.74	092	PAN-21.25	098
PAM-09.10	088	PAM-44.75	092	PAN-22.25	098
PAM-09.11	088	PAM-44.81	092	PAN-23.47	098
PAM-11.50	088	PAM-44.82	092	PAN-23.50	098
PAM-11.51	088	PAM-44.83	092	PAN-24.10	099
PAM-11.52	088	PAM-44.84	092	PAN-24.26	099
PAM-11.53	088	PAM-44.85	092	PAN-24.35	099
PAM-11.60	088	PAM-45.11	092	PAN-24.36	099

Item No.	Page No.	Item No.	Page No.	Item No.	Page No.
PAN-24.45	099	PAN-28.75	104	PAN-36.31	112
PAN-24.46	099	PAN-28.77	104	PAN-36.32	112
PAN-25.00	099	PAN-28.79	104	PAN-36.33	112
PAN-25.01	099	PAN-28.80	104	PAN-36.34	112
PAN-25.03	099	PAN-28.82	104	PAN-36.35	113
PAN-25.26	100	PAN-28.85	104	PAN-36.36	113
PAN-25.27	100	PAN-28.86	104	PAN-36.37	113
PAN-25.28	100	PAN-29.21	105	PAN-36.38	113
PAN-25.32	100	PAN-29.23	106	PAN-36.39	113
PAN-25.41	100	PAN-29.35	107	PAN-36.40	113
PAN-25.42	100	PAN-29.36	107	PAN-36.41	113
PAN-25.43	100	PAN-30.12	002	PAN-36.42	113
PAN-25.44	100	PAN-30.14	002	PAN-36.43	113
PAN-25.45	100	PAN-30.21	104	PAN-36.50	114
PAN-25.46	100	PAN-30.22	104	PAN-36.51	114
PAN-27.55	100	PAN-30.23	104	PAN-36.52	114
PAN-27.62	100	PAN-30.24	104	PAN-36.61	114
PAN-25.65	101	PAN-30.30	107	PAN-36.62	114
PAN-25.70	101	PAN-30.34	106	PAN-36.63	114
PAN-25.71	101	PAN-30.47	002	PAN-36.64	114
PAN-25.81	099	PAN-30.56	056	PAN-37.18	114
PAN-25.82	099	PAN-30.59	056	PAN-37.22	114
PAN-25.83	099	PAN-30.65	108	PAN-37.23	114
PAN-25.84	099	PAN-30.66	108	PAN-37.25	114
PAN-25.85	099	PAN-30.72	107	PAN-38.17	115
PAN-25.86	099	PAN-31.19	109	PAN-38.19	115
PAN-25.87	099	PAN-31.20	109	PAN-38.20	115
PAN-25.88	099	PAN-31.48	109	PAN-39.10	115
PAN-25.89	099	PAN-31.55	109	PAN-39.12	115
PAN-25.90	099	PAN-31.60	109	PAN-39.14	115
PAN-26.30	101	PAN-31.65	109	PAN-39.16	115
PAN-27.55	102	PAN-31.69	109	PAN-40.01	115
PAN-27.62	102	PAN-31.75	109	PAN-40.02	115
PAN-28.04	102	PAN-32.20	110	PAN-40.03	115
PAN-28.07	102	PAN-32.22	110	PAN-40.20	115
PAN-28.09	102	PAN-32.23	110	PAN-40.53	116
PAN-28.12	102	PAN-33.12	110	PAN-41.02	116
PAN-28.16	102	PAN-33.21	110	PAN-41.60	117
PAN-28.20	102	PAN-33.93	107	PAN-41.04	116
PAN-28.24	102	PAN-33.94	107	PAN-41.07	116
PAN-28.27	102	PAN-33.97	107	PAN-41.10	116
PAN-28.29	102	PAN-34.22	111	PAN-41.12	116
PAN-28.32	102	PAN-34.23	111	PAN-41.13	116
PAN-28.38	102	PAN-34.24	111	PAN-41.14	116
PAN-28.40	103	PAN-34.70	120	PAN-41.16	116
PAN-28.44	103	PAN-34.75	120	PAN-41.17	116
PAN-28.50	103	PAN-35.08	112	PAN-41.18	116
PAN-28.53	103	PAN-35.10	112	PAN-41.20	116
PAN-28.54	103	PAN-35.12	112	PAN-41.30	117
PAN-28.55	103	PAN-35.15	112	PAN-41.34	117
PAN-28.56	103	PAN-35.30	112	PAN-41.35	117
PAN-28.63	103	PAN-35.32	112	PAN-41.39	116
PAN-28.65	103	PAN-35.34	112	PAN-41.50	117
PAN-28.70	103	PAN-35.36	112	PAN-41.51	117
PAN-28.72	104	PAN-36.12	112	PAN-41.52	117
PAN-28.73	104	PAN-36.14	112	PAN-41.53	117
PAN-28.74	104	PAN-36.16	112	PAN-41.54	117



Item No.	Page No.	Item No.	Page No.	Item No.	Page No.
PAN-41.56	117	PAN-65.15	043	PAS-09.17	081
PAN-41.61	117	PAN-66.15	043	PAS-09.27	081
PAN-41.62	117	PAN-67.11	089	PAS-09.31	082
PAN-41.63	117	PAN-70.01	120	PAS-09.32	082
PAN-42.02	119	PAN-70.03	122	PAS-09.33	082
PAN-42.05	119	PAN-70.04	122	PAS-09.34	082
PAN-42.06	119	PAN-70.05	122	PAS-09.35	082
PAN-42.08	119	PAN-70.06	122	PAS-09.36	082
PAN-42.11	119	PAN-70.08	122	PAS-09.37	082
PAN-42.12	119	PAN-70.09	122	PAS-09.41	083
PAN-42.13	119	PAN-70.11	123	PAS-09.42	083
PAN-42.14	119	PAN-70.12	123	PAS-09.43	083
PAN-42.15	119	PAN-70.15	126	PAS-09.44	083
PAN-42.16	119	PAN-70.16	126	PAS-09.45	083
PAN-42.18	119	PAN-70.17	126	PAS-09.46	083
PAN-42.29	118	PAN-70.18	126	PAS-09.47	083
PAN-42.71	118	PAN-70.43	123	PAS-09.63	084
PAN-42.72	118	PAN-70.45	123	PAS-09.65	084
PAN-42.73	118	PAN-70.47	124	PAS-09.67	085
PAN-42.75	118	PAN-70.49	124	PAS-09.68	085
PAN-42.76	118	PAN-70.51	124	PAS-10.26	086
PAN-42.87	118	PAN-70.53	124	PAS-10.27	086
PAN-42.88	118	PAN-70.54	125	PAS-10.28	086
PAN-43.13	027	PAN-70.55	125	PAS-15.21	130
PAN-46.10	027	PAN-70.57	125	PAS-15.26	130
PAN-47.10	027	PAN-70.59	120	PAS-15.27	130
PAN-49.12	027	PAN-70.75	123		
PAN-50.03	121	PAN-75.07	123		
PAN-50.04	121	PAN-75.12	127		
PAN-50.06	121	PAN-81.31	127		
PAN-50.07	121	PAN-81.32	127		
PAN-50.08	121	PAN-82.11	127		
PAN-50.09	121	PAN-82.12	127		
PAN-50.10	121	PAN-82.20	127		
PAN-50.11	121	PAN-82.25	127		
PAN-50.12	121	PAN-82.80	127		
PAN-50.13	121	PAS-09.17	081		
PAN-50.14	121	PAN-84.00	002		
PAN-51.11	027	PAN-84.05	002		
PAN-51.134	028	PAP-40.17	128		
PAN-51.164	028	PAQ-06.10	128		
PAN-51.18	028	PAQ-07.15	128		
PAN-51.34	028	PAQ-13.45	128		
PAN-51.43	027	PAQ-14.60	128		
PAN-51.64	028	PAQ-18.00	128		
PAN-52.114	028	PAQ-18.11	128		
PAN-52.14	028	PAQ-18.12	128		
PAN-54.19	029	PAQ-18.13	128		
PAN-55.20	029	PAQ-19.00	129		
PAN-56.31	029	PAQ-19.05	129		
PAN-56.32	029	PAQ-19.06	129		
PAN-56.33	029	PAQ-19.07	129		
PAN-60.15	043	PAS-03.15	129		
PAN-62.13	043	PAS-03.34	130		
PAN-62.15	043	PAS-07.35	131		
PAN-64.15	043	PAS-07.36	131		
PAN-64.30	003	PAS-07.37	131		



Item Name	Page No.
<b>A</b>	
Abdominal retractor	076
ADSON-BROWN Delicate forceps,dressing and tissue	039
ADSON Delicate forceps dressing and tissue	038
ADSON Delicate forceps, tissue	039
ADSON Delicate retractors	067
ADSON-GRAEFE Delicate forceps, dressing and tissue	040
ADSON-TOENNIS Dissecting Scissors	014
AIACH Forceps	064
Alar hooks	094
Alar retractors	094
ALM Self-retaining retractors	079
Anthelx Cartilage file	099
Areola marker	073
ASCH Septum straightening forceps	105
Atraumatic breast dissector	074
AUFRICHT-GUBISCH Nasal retractors	096
AUFRICHT Nasal rasps	100
AUFRICHT Nasal retractors	095-096
AUFRICHT Rhinoplasty scissors	028
AUFRICHT-WALTER Nasal retractors	095
<b>B</b>	
BABY-FARABEUZ Retractors	071
BABY-METZENBAUM Delicate dissecting scissors	010
BALLENGER Chisels	090
BARBON-LUBET Nasal dressing forceps	088
BARSKY Skin hooks	068
BENICKE Delicate retractors	069
BERGMANN Delicate retractors	069
Blade osteotomes	116
BLAKESLEY Nasal forceps	093
BLAKESLEY-WEIL Ethmoid bone forceps	093
BLAKESLEY-WEIL Nasal forceps	092
Blepharoplasty scissors	022
BLOCKSMA Cleft palate hooks	127
BLUME Osteotomes	115
BOIES Nasal fracture elevator	109
Bone bending pliers	107
Bone bow spacer	003
Bone instruments	120,107
Bone lever	103
Bone mill	120
Bowl for marking colour	073
BOZEMANN (WERTHEIM) Needle holders	054
Breast dissectors	074
Breast elevator	073
Breast retractors	075
BROWN-ADSON Delicate forceps,dressing and tissue	039
BRUENINGS-LUC (HEYMANN) Nasal septum forceps	091
BRUESER-KELLY Delicate dissecting scissors	015
Bulldog clamps	046
Bulldog scissors	027
<b>C</b>	
Calipers	002-003
CAPLAN Nasal septum scissors	029
Cartilage abraders	099
Cartilage crushers	120
Cartilage cutting block	120
Cartilage instruments	120
Cartilage scissors	028
CASTROVIEJO Calipers	003
CASTROVIEJO-EPKER Calipers	003
Channel retractors	086
Cheek retractors	130

Item Name	Page No.
Chin retractor	086
Chisels	90,115,116
Cinelli Osteotomes	115
CINELLI Rhinoplasty scissors	027
CLAUS-KILLIAN Septum gouges	090
Cleft palate hooks	127
Cleft palate raspatories	127,131
COHEN Elevators	062
COLLIER Needle holders	050
Columella forceps	089
CONVERSE-DERF Needle holders	057
CONVERSE Nasal file	101
CONVERSE Nasal retractors	096
CONVERSE Needle holders	050
CONVERSE Raspatories	109
CONVERSE Rhinoplasty knives	097
CONVERSE Rhinoplasty scissors	027
COPE Delicate retractors	066
COPE-WALTER Nasal retractors	066
COTTLE Alar and skin hooks	094
COTTLE Alar retractors	095
COTTLE Bone lever and splitting Osteotome	102
COTTLE Bulldog scissors	027
COTTLE Cartilage crushers	120
COTTLE Chisels	102
COTTLE Columella forceps	088
COTTLE Delicate retractors	069
COTTLE Elevators	109
COTTLE-FOMON Septum forceps	104
COTTLE-GUBISCH Chisels	102
COTTLE-MASING Mucosa needle holders	056
COTTLE-MASING Rhinoplasty scissors	027
COTTLE Mallets	060
COTTLE-McKENTY Raspatories	111
COTTLE Nasal rasps	098
COTTLE Nasal retractors	094
COTTLE Nasal septum scissors	029
COTTLE Nasal septum speculum	088
COTTLE Nasal specula	088
COTTLE-NEIVERT Nasal retractors	094
COTTLE Osteotomes	102
COTTLE Raspatories	062,108
COTTLE Rhinoplasty knives	097
COTTLE Rhinoplasty scissors	026-027
COTTLE Septum elevators	110
COTTLE Tissue grasping forceps	043
COTTLE Tunnelling elevator	111
COTTLE-WALTER Rhinoplasty scissors	026
CRAIG Vomer forceps	091
CRAIG-DOMNICK Vomer forceps	091
CRILE Delicate retractors	067
CRILE-WOOD Needle holders	052
Curette	062
Cylinder osteotomes	119
<b>D</b>	
DEAN Gum scissors	025
EBAKEY Tissue grasping forceps	041
Delicate dissecting scissors	006-022
Delicate forceps, dressing and tissue	038-042
Delicate forceps, tissue	043
Delicate retractors	065,072
Delicate scissors	006-008
DENHART Mouth gags	128
DERF-CONVERSE Needle holders	051
Dermatomes	036
DESMARRES Lid retractors	081
DIETHRICH Hemostatic forceps	046
Dilation rods	121
DINGMANN Cartilage abraders	099
DINGMANN Mouth gags	128
Dissecting scissors	006-022
Dissectors	123

Item Name	Page No.	Item Name	Page No.
DOMNICK-CRAIG Vomer forceps	091	HALSEY Needle holders	051
<b>E</b>		HALSTED-MOSQUITO Hemostatic Forceps	047
Elevators	061-063,124,127	HARGIS Raspatories	113
EMMET Fistula hook	069	HARTMANN Nasal dressing forceps	091
ENTNER Ligature needles	125	HARTMANN Nasal specula	088
EPKER-CASTROVIEJO Calipers	003	Hemostatic forceps	046-048
Ethmoid bone forceps	092	HEYMANN Nasal septum forceps	091
EWALD-HUDSON Delicate forceps,dressing and tissue	038	HEYMANN Rhinoplasty scissors	025
<b>F</b>		Hook dissector	1074
Facelift marker	003	Hook scissors	126
FANOUS Dissecting Scissors	020	HOSPITAL-PROVIDENCE Hemostatic Forceps	048
FANOUS-GUBISCH Osteotomes	103	HUDSON-EWALD Delicate Forceps, Dressing and tissue	038
FANOUS Osteotomes	103	HUMBY Delicate Retractors	069
FANOUS Rhinoplasty Scissors	028	HUMBY Dermatomes	036
FANOUS Undermining scissors	020	<b>I</b>	
FARABEUF-BABY Retractors	071	Iliac crest retractors	085
FARABEUF Retractors	071	Interdental osteotomes	115
Finger goniometer	002	IRIS Iris scissors	006
FINSEN Self-retraining retractors	079	Iris scissors	006
Fistula hook	069	<b>J</b>	
Fixation wire with needles	064	JACKSON Delicate retractors	128
Flexometer	002	JACKSON Tracheal hooks	068
FOMON COTTLE Septum forceps	104	JACOBSON-MICRO Hemostatic Forceps	047
FOMON GUBISCH Nasal rasps	101	JAMESON Calipers	002
FOMON Nasal rasps	100	JAMESON Delicate dissecting scissors	019
FOMON Osteotomes	115	JOSEPH Delicate dissecting scissors	017
FOMON Rhinoplasty scissors	121	JOSEPH Delicate retractors	068
Forceps, dressing and tissue	041	JOSEPH Nasal saws	098
FOX Gum scissors	023	JOSEPH Rhinoplasty knives	087
FOX Tissue grasping forceps	043	JOSEPH Rulers	002
FOX Tissue holding forceps	043	JOSEPH Septum cartilage knife	092
FRAZIER Dura and skin hooks	067	JOSEPH-MASING Septum raspator	109
FREEMAN-GORNEY Dissecting Scissors	021	JOSEPH-PECK Delicate dissecting Scissors	118
FREEMAN-METZENBAUM Dissecting Scissors	015	<b>K</b>	
FREER Chisels	090	KAHRE Cleft palate raspatories	127
FREER Delicate retractors	069	KAYE Blepharoplasty scissors	022
FREER Elevators	062	KAYE Dissecting scissors	021
FREER Mucosa knife	090	KELLY-BRÜSER Delicate dissecting Scissors	015
FREER-OBWEGESER Raspatories	114	KELLY Dissecting scissors	016
FREER Raspatories	061	KELLY Stich scissors	023
<b>G</b>		KILLIAN-CLAUS Septum gouges	090
GILLIES Delicates forceps,Dressing and tissue	041	KILLIAN Nasal specula	089
GILLIES Delicate Retractors	067	KILLIAN Septum gouges	090
GILLIES Needle Holders	055	KILNER Alar retractors	095
GILLIES-OBWEGESER Needle Holders	055	KILNER-GUBISCH Alar retractors	095
GILLIES-SLIM Needle holders	055	KISTLER Anthelix cartilage file	099
GIUNTA Rhinoplasty scissors	027	KLEINERT-KUTZ Skin hooks	068
GOLDMAN Septum fracture elevator	109	KNAPP Delicate dissecting scissors	008-009
GORNEY Dissecting scissors	020	Knife inserts	121
GORNEY-FREEMAN Dissecting Scissors	021	Knives	121
GRAEFE-ADSON Delicate forceps, Dressing and tissue Grasping forceps	040 126	KOCHER Retractors	072
GREENGERG PAR delicate dissecting Scissors	017	KRETSCHMER Reference pin	002
GREEN-LANGENBECK Delicate Retractors	067	KUTZ-KLEINERT Skin hooks	068
GREEN-SENN Delicate retractors	067	<b>L</b>	
GRUENWALD bayonet forceps	042	LAHEY-CLINICH Dura and skin hooks	070
GUBISCH-AUFRIEHT Nasal Retractors	096	LANGENBECK Elevators	061,063
GUBISCH Cartilage crushers	120	LANGENBECK-GREEN Delicate Retractors	067
GUBISCH-COTTEL Chisels	102	LANGENBECK Retractors	072
GUBISCH-FANOUS Osteotomes	103	LEPERT Raspatories	062
GUBISCH-FOMON Nasal rasps	101	LERICHE Hemostatic forceps	048
GUBISCH-KILNER Alar retractors	095	LEWIS Nasal rasps	099
GUBISCH Needle holders	051	LEXER-BABY Delicate dissecting Scissors	007
GUBISCH Osteotomes	116	LEXER Dissecting scissors	010
GUBISCH Pen holder	003	LEXER-MAYO Dissecting scissors	007
<b>H</b>		Lid grasping forceps	043

Item Name	Page No.
Lid retractors	081
Ligature needles	125
Lip instruments	127,130-131
Lip retractors	130
LITTAUER Stitch scissors	023
LITTLER Suture carrying scissors	021
LUBET-BARBON Nasal dressing Forceps	088
LUC-BRUENINGS (HEYMANN)	
Nasal Septum forceps	091

### M

Mallets	060
MALTZ Nasal rasps	098
Mandibular rim retractor	081
Marking instruments	002-003
MARX Breast retractors	075
MASING Alar retractors	094
MASING-COTTLE Mucosa needle Holders	056
MASING-COTTLE Rhinoplasty scissors	027
MASING-JOSEPH Septum raspatory	109
MASING Nasal file	101
MASING Nasal rasps	101
MASING Septum elevators	110
MATHIEU Needle holders	056
Maxila mobilizer	118
MAYO Dissecting scissors	010
MAYO-HEGAR Needle holders	053
MAYO-LEXER Dissecting scissors	007
McINDOE Cartilage scissors	028
McINDOE Chisels	112
McINDOE Cleft palate raspatories	127
McINDOE Delicate forceps, Dressing and tissue	040
McKENTY-COTTLE Raspatories	111
McKENTY Raspatories	061
Measuring instruments	002-003
MERSHON Wire positioner	064
METZENBAUM-BABY Delicate Dissecting scissors	010
METZENBAUM Dissecting Scissors	010-111
METZENBAUM-FREEMANN Dissecting Scissors	015
METZENBAUM-NELSON Dissecting Scissors	012-013
METZENBAUM-SLIM Dissecting Scissors	013-014
MEYERDING Delicate retractors	071
MICRO-ADSON Delicate forceps, Dressing and tissue	042
MICRO-HALSTED Hemostatic forceps	049
MICRO-IRIS Iris scissors	006
MICRO-JACOBSON hemostatic Forceps	047
Micro Needle holders	057
MILLARD (COTTLE) Nasal retractors	094
MILLAR-SENN Delicate retractors	066
MINI-METZENBAUM Delicate Dissecting scissors	012
MOBERG Chisels	112
MOD. WIEN Nasal specula	089
MOLT mouth gags	128
MOLTGEN Flexometer	002
MOSQUITO Hemostatic forceps	046
MOSQUITO-HALSTED Hemostatic Forceps	047
Mouth Gags	128
Mucoperiost retractors	131
Mucosa knife	061
Mucosa needle holders	056

### N

NAGATA Elevators	061
NAGATA Needle holders	050
NAGATA Sculpture knives	035
Nasal dressing forceps	087
Nasal file	101
Nasal forceps	092-093
Nasal fracture elevator	109
Nasal rasps	98-100

Item Name	Page No.
Nasal retractors	94-95
Nasal ridge scissors	098
Nasal saws	098
Nasal septum forceps	091
Nasal septum osteotomes	118
Nasal septum scissors	029
Nasal septum speculum	088
Nasal specula	088-089
Nasal spine retractor	084
Navel Marker	077
Needle Holders	050-057
Needle holders with scissors	055
NEIVERT-COTTLE Nasal retractors	094
NEIVERT Nasal retractors	094
NEIVERT Needle holders	050
NELSON-METZENBAUM Dissecting Scissors	012-013
NELSON Tissue grasping forceps	041
Nerve Hooks	123-124
NEWS Tracheal hooks	068
NIRO Wire twisting forceps	064
Nose tip marker	002

### O

O'BRIEN Stitch scisors	024
OBWEGESER Blade osteotomes	116
OBWEGESER Bone bending pliers	107
OBWEGESER Channel retractors	086
OBWEGESER Chin retractors	086
OBWEGESER-FREER Raspatories	113
OBWEGESER-GILLIES Needle Holders	055
OBWEGESER lilac crest retractors	085
OBWEGESER Interdental osteotomes	116
OBWEGESER Mandibular rim retractor	081
OBWEGESER Maxilla mobilizer	118
OBWEGESER Nasal rasps	100
OBWEGESER Nasal ridge scissors	029
OBWEGESER Nasal septum Osteotomes	118
OBWEGESER Nasal spine retractor	084
OBWEGESER Osteotomes	115-117
OBWEGESER Pterygoid osteotomes	117
OBWEGESER Ramus retractors	081
OBWEGESER Raspatories	112-113
OBWEGESER Rib raspatories	108
OBWEGESER Septum forceps	106
OBWEGESER Soft tissue retractors	082-083
OBWEGESER Splitting osteotomes	116
OBWEGESER Wedge osteotomes	116
OBWEGESER Wire loop forceps	064
OBWEGESER Wire twister	064
OBWEGESER Wisdom tooth retractor	084
Orbita floor raspatory	113
Orbital osteotomes	118
Osteotomes	111-118

### P

PECK-JOSEPH Delicate Dissecting scissors	018
Pen Holder	003
PENNINGTON Elevators	090
PITANGUY facelift marker	003
PROVIDENCE-HOSPITAL Hemostatic Forceps	048
Pterygold osteotome	117

### R

RAGNELL (KILNER) Delicate Dissecting scissors	016
RAGNELL Delicate retractor	066
Ramus retractors	081
Raspatoires	108-109,111,113,114,122
Reference pin	002
Retractor with fiber optic illumination	096
Retractors	066-072

Item Name	Page No.
REYNOLDS (JAMESON)	
Dissecting Scissors	024-029
Rhinoplasty knives	097
Rhinoplasty scissors	024-029
Rib raspatories	108
Rib raspatories	086
ROSER KOENIG Mouth gags	128
RUBIN Chisels	112
RUBIN-GUBISCH Septal morselizer Forceps	107
RUBIN Osteotomes	103
RUBIN Septal morselizer forceps	107
Rulers	002

## S

SALDANHA-SOLZ Abdominal Retractors	076
Scalpel blades	032-034
Scalpel handles	032-034
Scalpels	032-034
SCHINK Dermatomes	036
SCHROM Osteotomes	104
Scissors	006-030
Sculpture knives	035
Self-retaining retractors	079-080
SEMKEN Delicate retractors Dressing and tissue	040
SENN-GREEN Delicate retractors	066
SENNING Needle holder	054
SENN-MILLER Delicate retractors	066
Septal morselizer forceps	107
Septum cartilage knives	106
Septum elevators	109
Septum forceps	104
Septum fracture elevator	090
Septum gouges	102
Septum raspatory	062
Septum straightening forceps	104-105
SHEPARD Cylinder osteotomes	119
SIEGERT Undermining scissors	016
SILVER Dermatomes	036
SILVER Osteotomes	115
Skin hooks	068
SLIM Delicate dissecting scissors	018
SLIM-GILLIES Needle holders	055
SLIM-METZENBAUM Dissecting Scissors	013-014
Soft tissue retractors	082-083
SOLZ Areola marker	073
SOLZ Atraumatic breast dissector	074
SOLZ Dissecting scissors	032
SOLZ Hook dissector	074
SOLZ Navel marker	077
SPENCER Stitch scissors	023
Splitting osteotome	104,116
STEINHAEUSER Orbita floor raspatory	114
STEINHAEUSER Orbital osteotomes	118
STERNBERG Cheek retractors	129
STEVENS Delicate dissecting Scissors	007
STEVENS Iris scissors	007
STILLE-MAYO Dissecting scissors	009
STILLE-STRANDELL Delicate Retractors	067
Stitch scissors	023
STRAIGHT Dura and skin hooks	068
STRANDELL-STILLE Delicate Retractors	067
Suction elevator	110
Suction raspatories	107
Suture carrying scissors	027
Sutruing forceps	042

## T

TEBBETTS Retractors	078
TESSIER Osteotomes	117
TESSIER Raspatories	114
THOMSON-WALKER (BOZEMANN)	
Needle holder	054
THORPE Calipers	002

Item Name	Page No.
TIECK-HALLE Nasal specula	088
Tissue grasping forceps	041,043
Tissue holding forceps	043
TOENNIS-ADSON Dissecting scissors	014
Tongue depressor	128-129
Tracheal hooks	068
Trocars	119
TROELTSCH (WILDE) Tissue grasping Forceps	042
Tunnelling raspatory	111

## U

Undermining scissors	020
UNIV. MINNESOTA Cheek retractors	130
UNIVERSAL Wire cutting scissors	024

## V

Vestibule retractor	130
Vomer forceps	091

## W

WALKER-THOMSON (BOZEMANN)	
Needle holder	054
WALSHAM Septum straightening Forceps	104
WALSHAM "UNIVERSAL" Septum Forceps	104
WALTER-AUFRIEHT Nasal retractors	095
WALTER-COPE Nasal retractors	066
WALTER-COTTLE Rhinoplasty scissors	026
WALTER Lid grasping forceps	043
WALTER Osteotomes	104
WALTER Raspatories	062
WALTER Retractors	071
WALTER Rhinoplasty scissors	026
WALTER Tissue grasping forceps	041
WALTER-WILLIGER Curette	062
WANG Lip and cleft palate Instruments	063
WANG Raspatories	063
WANG Mouth gags	129
WATSON Dermatomes	036
WATSON Forceps, dressing and tissue	041
Wedge osteotomes	116
WEIL-BALKESLEY Ethmoid bone Forceps	092
WEIL-BLAKESLEY Nasal forceps	093
WEITLANER Self-retaining retractors	080
WESTMACOTT Nasal dressing Forceps	087
WIENER MOD. Nasal specula	089
WILLIGER Raspatories	061
WILLIGER-WALTER Curette	062
Wire cutting scissors	024
Wire Instruments	064
Wire loop forceps	064
Wire pusher	064
Wire twister	064
Wire twisting forceps	064
Wires	064
Wisdom tooth retractor	084
WOOD-CRILE Needle holders	052
WRIGTH (DERF) Needle holders	051

## Y

YANKAUER Septum elevator	109
--------------------------	-----





Снабжение  
Медицинских  
Учреждений



<http://medtehural.ru/>

Уважаемые дамы и господа, коллеги и партнёры!

Наша организация осуществляет полный цикл снабжения медицинских учреждений, косметологических клиник, салонов красоты и реабилитационных центров. Мы плотно сотрудничаем со многими российскими и зарубежными производителями продукции медицинского назначения и оборудования. Товары, представленные на нашем сайте, являются высококачественными и имеют все необходимые разрешительные документы. Компания "Медицинские Технологии Урала" находится в городе Екатеринбурге. Город равноудален как от Москвы, так и от Новосибирска. По этому, скорость и удобство доставки груза практически по всей России являются наиболее удобными и примерно одинаковыми. Сотрудничая с нашей компанией, Вы получаете надежного и эффективного партнера!

*ООО "Медицинские Технологии Урала", желает Вам  
Здоровья и Процветания на долгие года*

*Доставка товаров по России и странам ТС осуществляется  
любой удобной для Вас транспортной компанией с соблюдением  
температурного режима.*

*Мы заботимся о безопасности Вашего груза! Сотрудничая с нами,*

*Вы делаете правильный выбор!*

